

CASANOVO

HELMIS 100P140

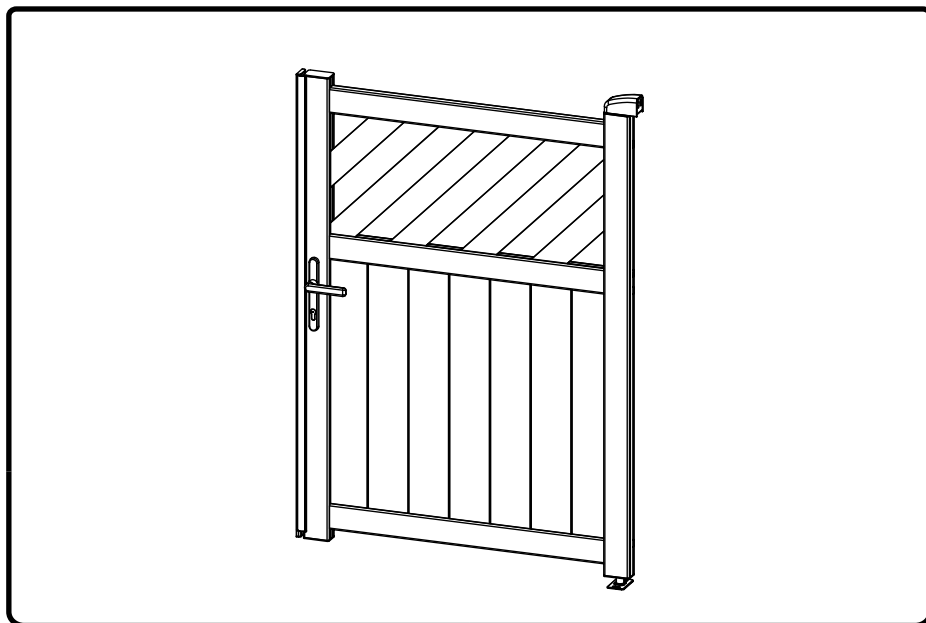

3-5H



X 2





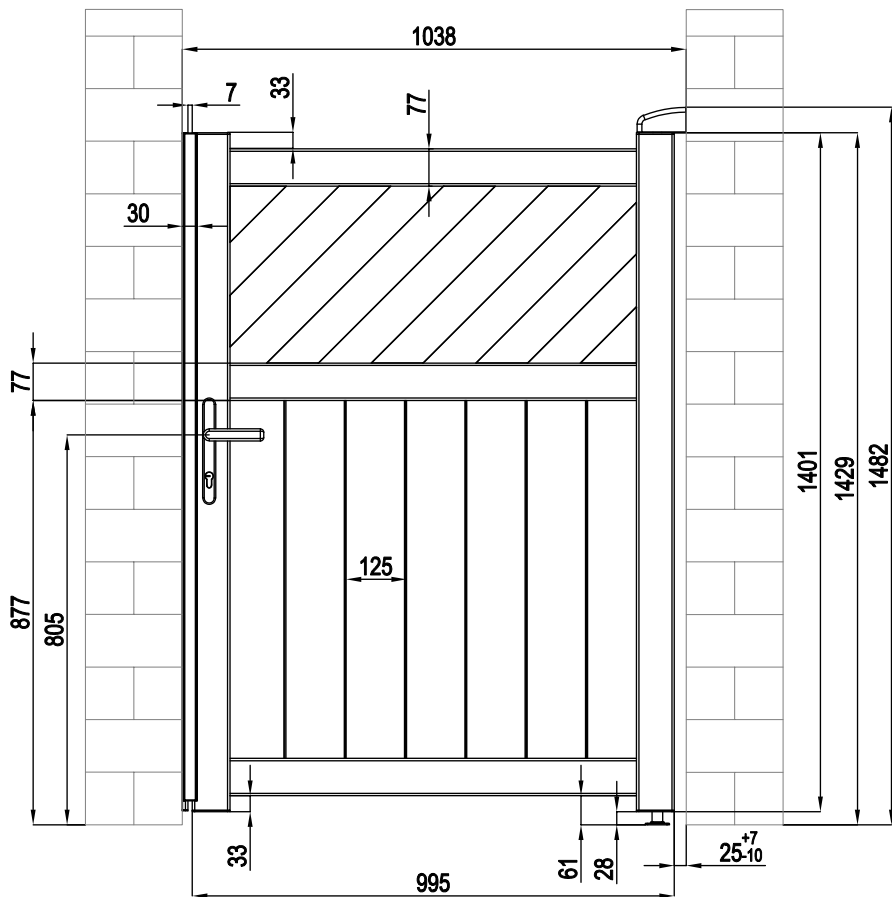

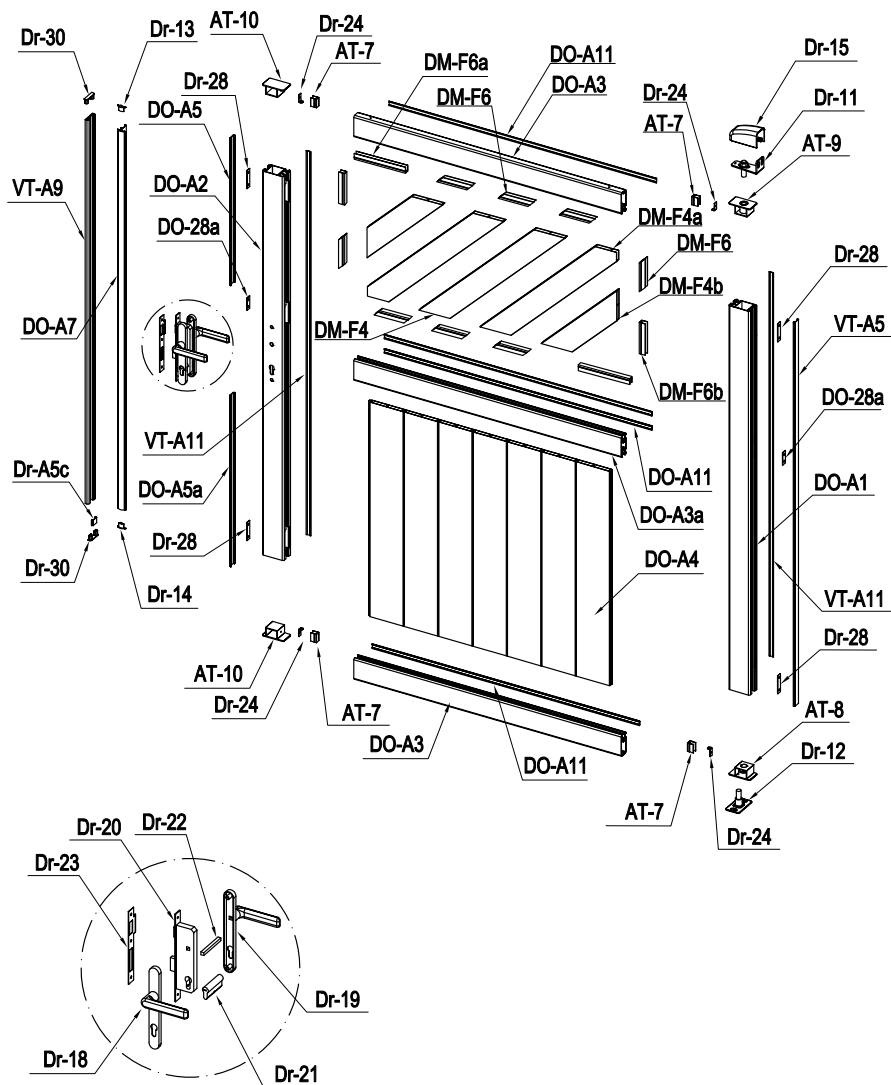

































EN FR DE ES PT IT NL PL FI SE DK
RO SI SK HU CZ HR GR LT LV

INSTRUCTION MANUAL / NOTICE DE MONTAGE / MONTAGEANLEITUNG / MANUAL DE MONTAJE / MANUAL DE MONTAGEM / MANUALE DI MONTAGGIO /
MONTAGEHANDLEIDING / INSTRUKCJA MONTAŻU / KÄYTTÖOHJEET / BRUKSANVISNING / BRUGSANVISNING / INSTRUCIUNI DE ASAMBLARE /
NAVODILA ZA SESTAVLJANJE / NÁVOD NA MONTÁŽ / ÖSSZESZERELÉSI ÚTMUTATÓ / NÁVOD K MONTÁŽI / UPUTE ZA INSTALACIJU /
ΟΔΗΓΙΕΣ ΣΥΝΑΡΜΟΛΟΓΗΣΗΣ / SURINKIMO INSTRUKCIJOS / MONTĀŽAS INSTRUKCIJAS









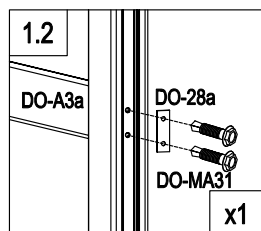
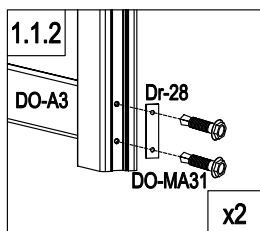
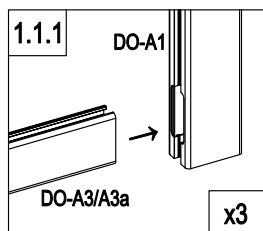
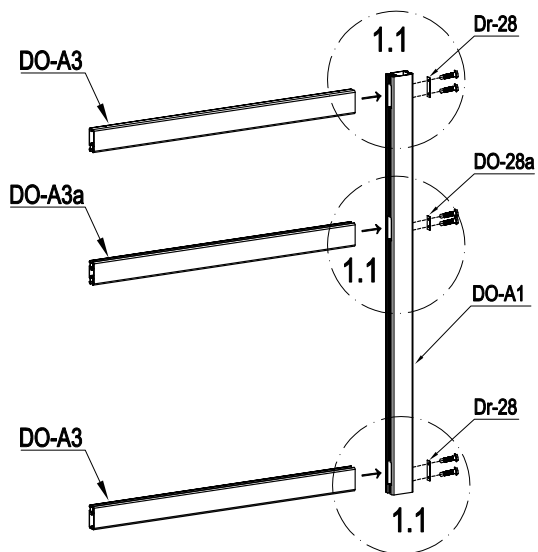

PART LIST

IMAGE	NO.	L.(mm)	QTY	IMAGE	NO.	L.(mm)	QTY
	DO-A1	1395	1		Dr-30		2
	DO-A2	1395	1		Dr-31		2
	DO-A3	972	2		DO-30		4
	DO-A3a (+DO-A15)	972	1		Dr-18		1
	DO-A4	779	7		Dr-19		1
	DM-F4	651	1		Dr-20		1
	DM-F4a	627	2		Dr-21		1
	DM-F4b	377	2		Dr-22		1
	VT-A5	1395	1		Dr-23		1
	DO-A5	532.5	1		Dr-25		1
	DO-A5a	622	1		Dr-25a		2
	Dr-A5c	19.5	1		Dr-26		3
	VT-A11	1395	2		Dr-27		2
	DO-A11	972	4		Dr-24		4
	AT-7	29.5	4		Dr-28		4
	DM-F6	126	8		DO-28a		2
	DM-F6a	181	2		DO-MA30	ST4x10	4
	DM-F6b	114	2		DO-MA31	ST5.5x38	12
	DO-A7	1375	1		DO-MA32	ST4.8x38	6
	VT-A9	1395	1		DO-MA33	M8x60	6
	AT-8		1		DO-MA34	M6x50	3
	AT-9		1		DO-MA35	ST4.2x13	26
	AT-10		2				
	Dr-11		1				
	Dr-12		1				
	Dr-13		1				
	Dr-14		1				
	Dr-15		1				
	Dr-17		1				



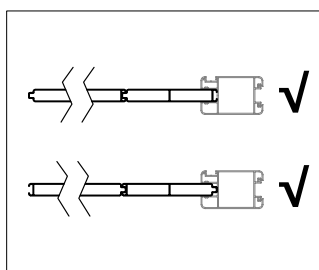
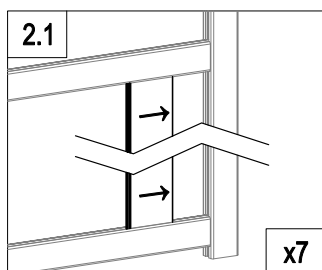
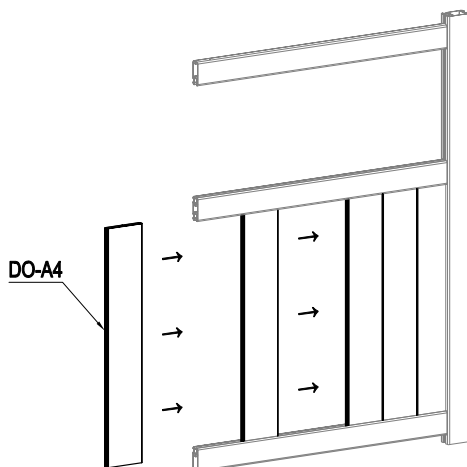

	DO-A1	1
	DO-A3	2
	DO-A3a	1

	Dr-28	2
	DO-28a	1
	DO-MA31	6

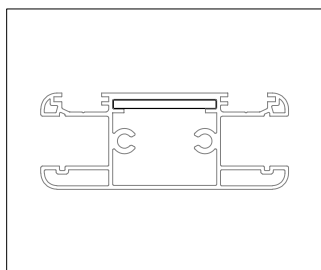
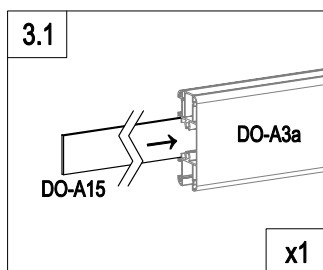
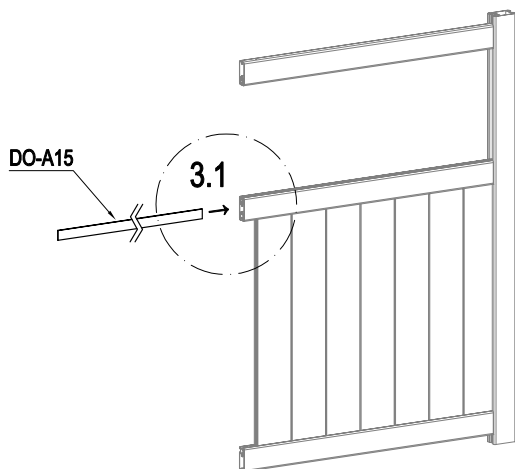

	DO-A4	7
---	-------	---





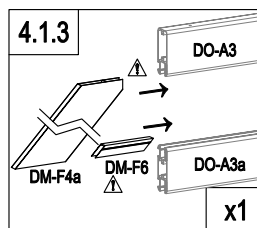
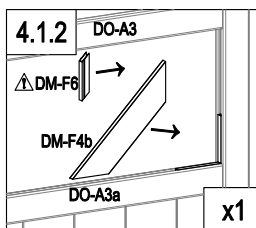
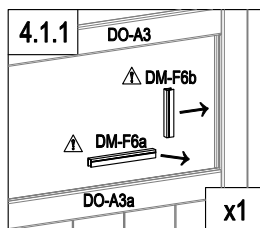
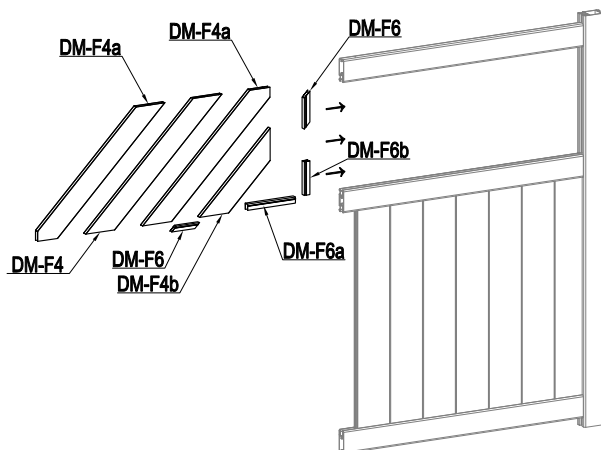

	DO-A15	1
---	--------	---

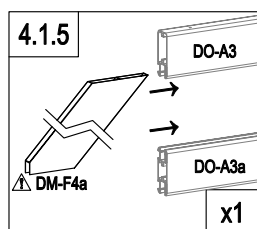
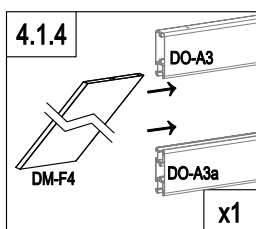

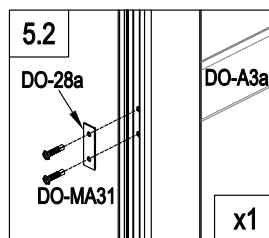
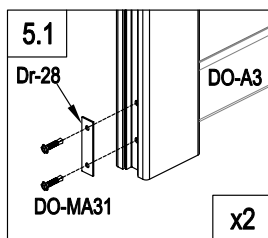
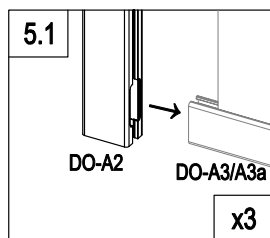
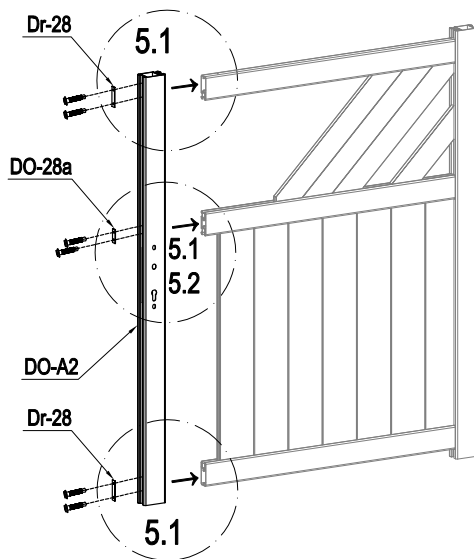
	DM-F4	1
	DM-F4a	2
	DM-F4b	1
	DM-F6	2
	DM-F6a	1
	DM-F6b	1





	DO-A2	1
	Dr-28	2
	DO-28a	1
	DO-M31	6

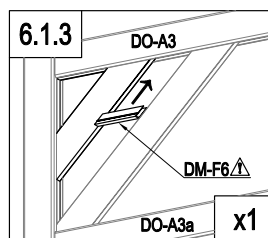
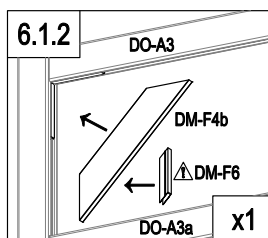
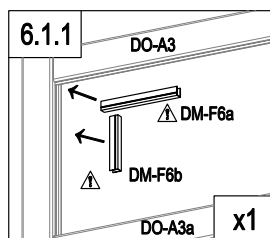
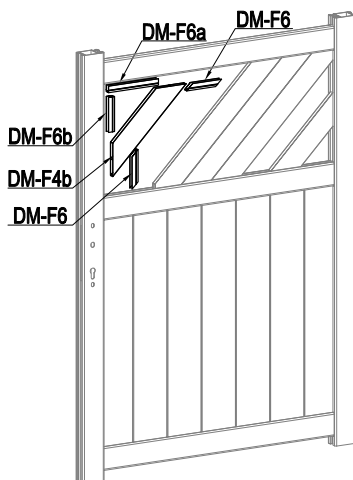

	DM-F4b	1
	DM-F6	2
	DM-F6a	1
	DM-F6b	1

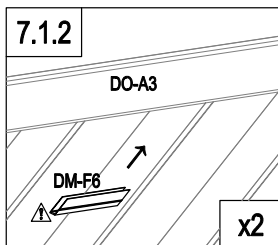
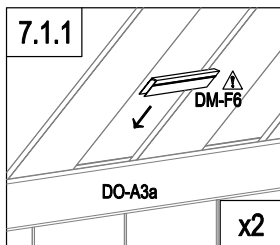
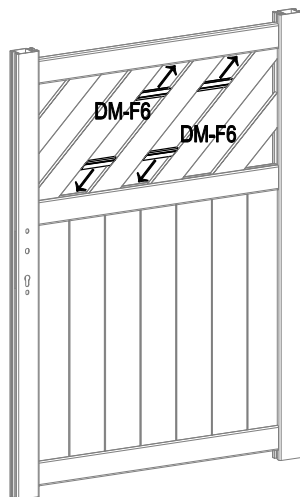

	DM-F6	4
---	-------	---

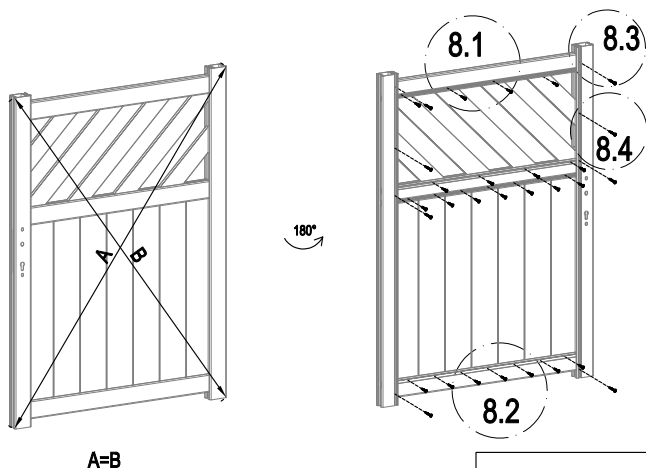

A=B

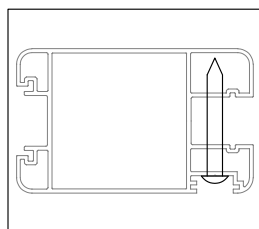
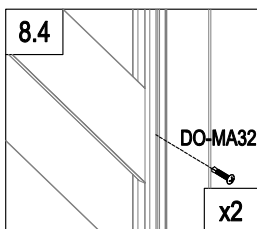
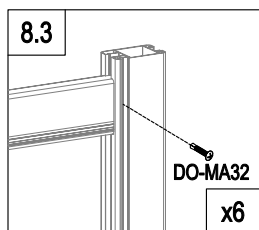
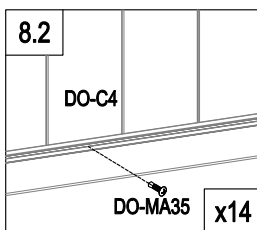
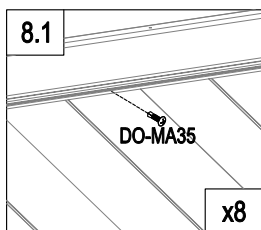
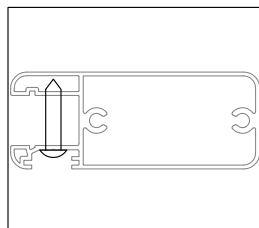

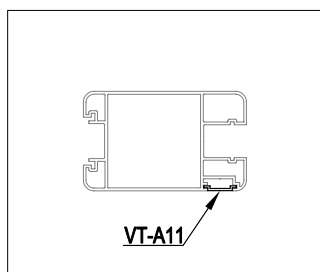
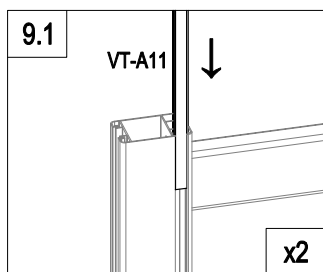
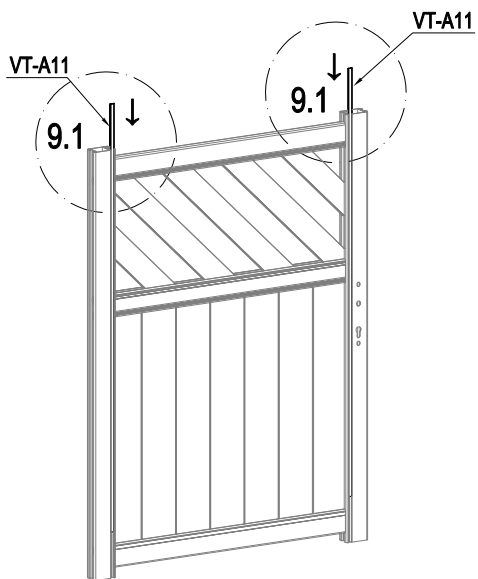

	DO-M35	22
	DO-M32	8

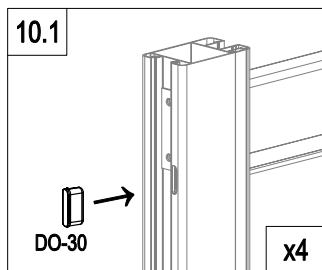
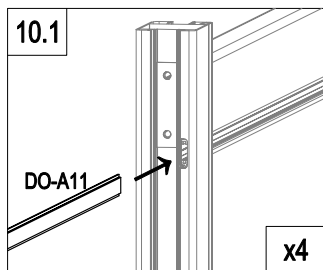
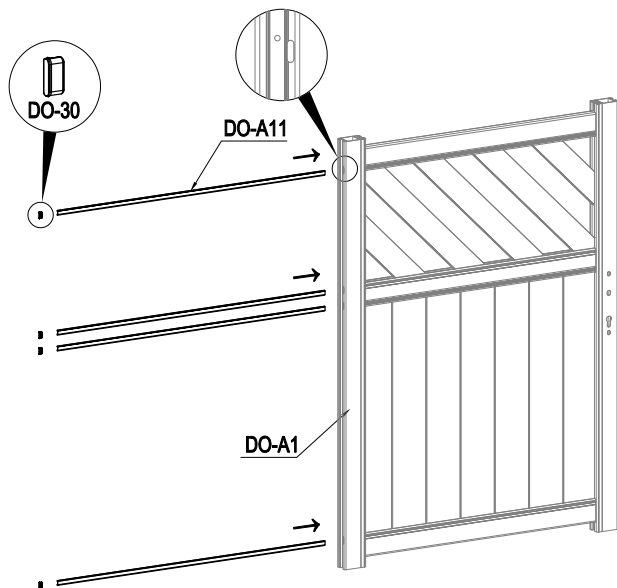

	VT-A11	2
---	--------	---



	DO-A11	4
	DO-30	4

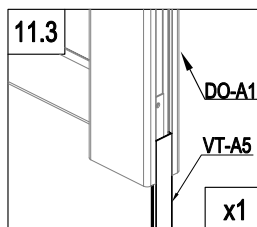
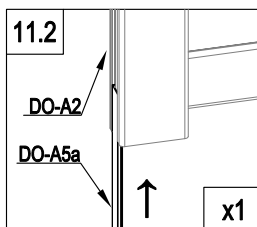
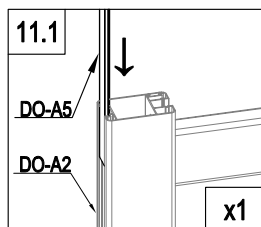
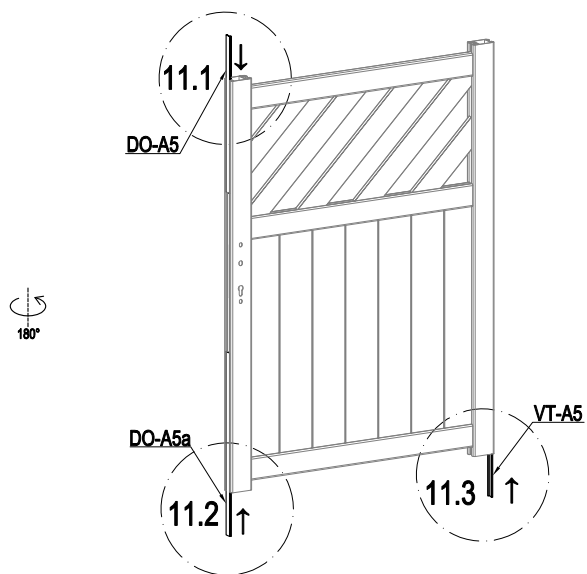

	VT-A5	1
	DO-A5	1
	DO-A5a	1

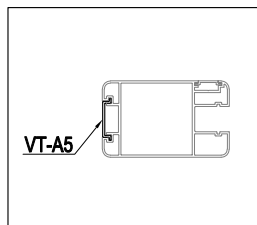

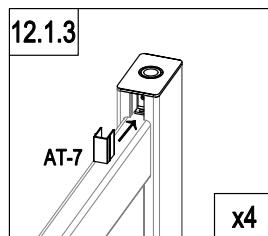
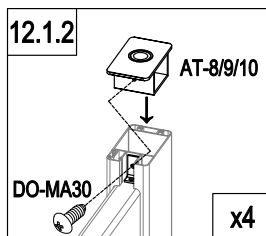
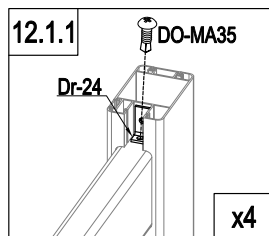
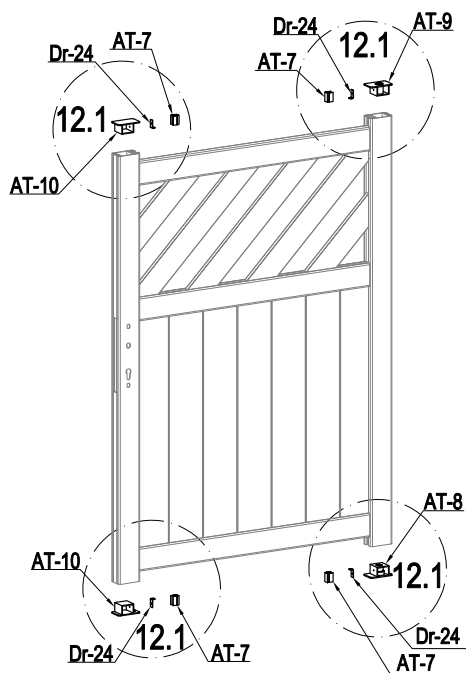

	AT-8	1
	AT-9	1
	AT-10	2
	Dr-24	4

	AT-7	4
	DO-A30	4
	DO-MA35	4

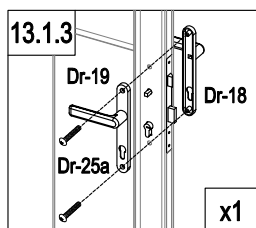
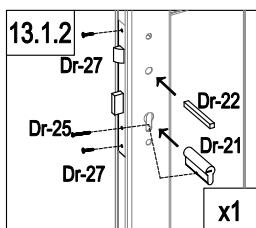
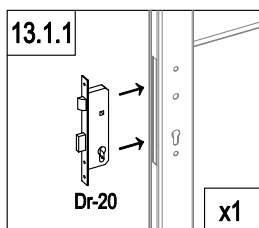
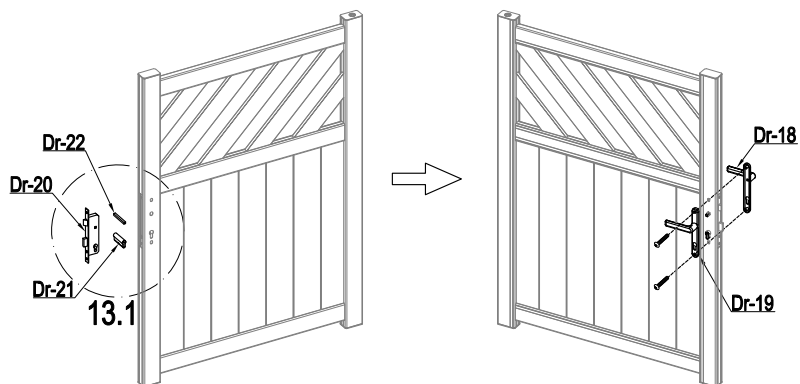

	Dr-20	1
	Dr-21	1
	Dr-22	1
	Dr-25	1

	Dr-18	1
	Dr-19	1
	Dr-25a	2
	Dr-27	2

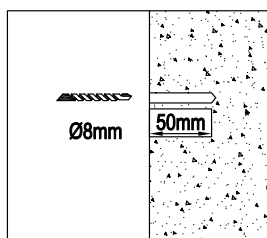
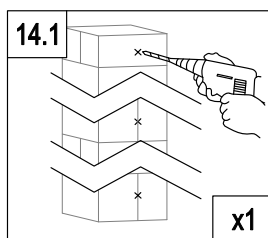
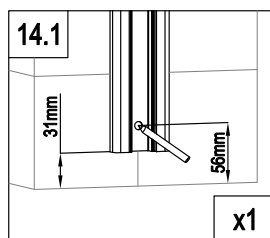
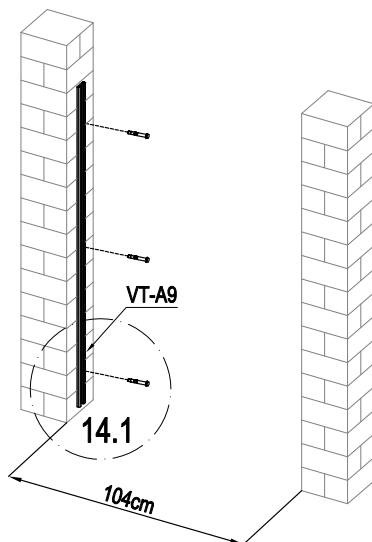

	VT-A9	1
	DO-MA34	3

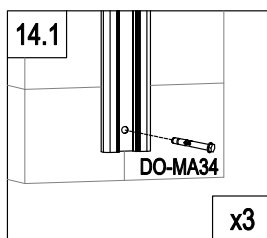

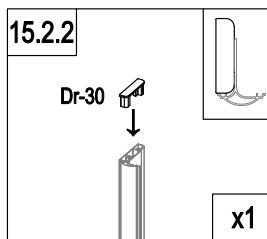
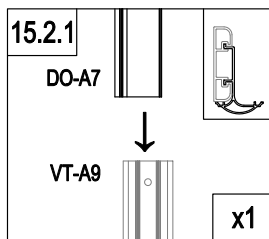
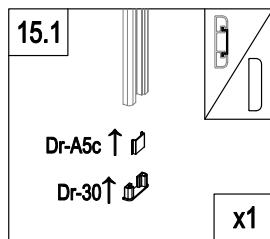
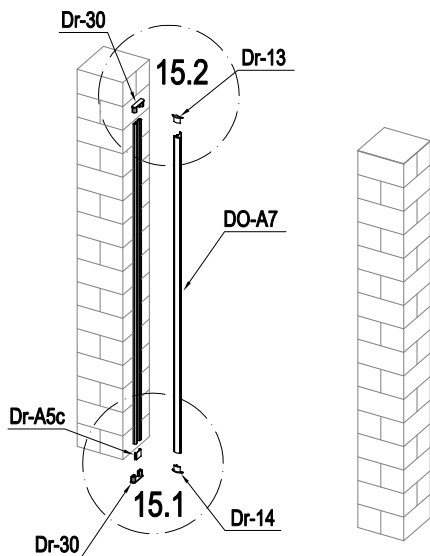

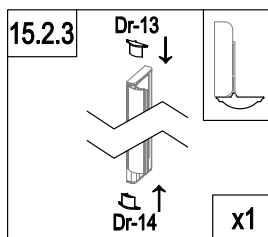

	DO-A7	1
	Dr-13	1
	Dr-14	1
	Dr-30	2
	Dr-A5c	1

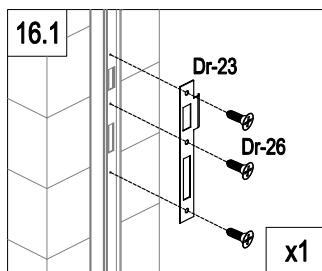
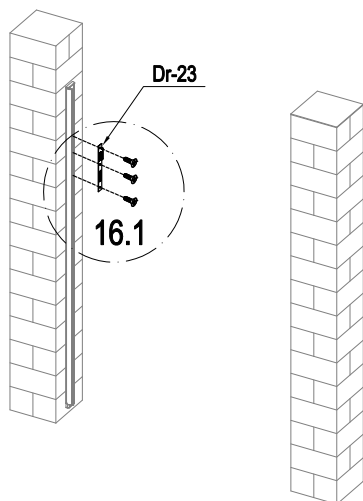



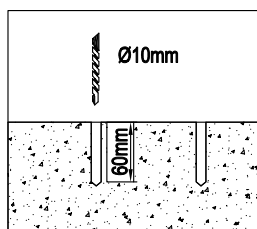
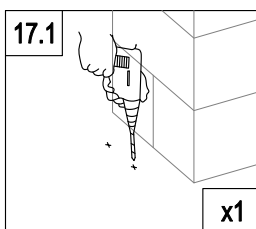
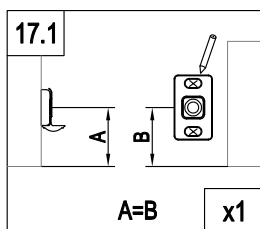
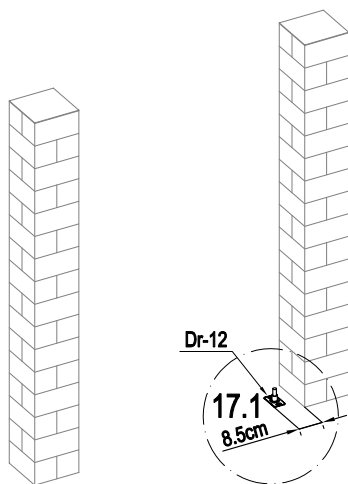

	Dr-23	1
	Dr-26	3

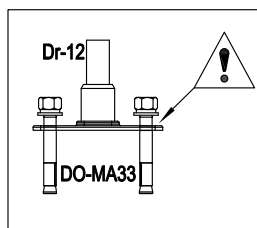
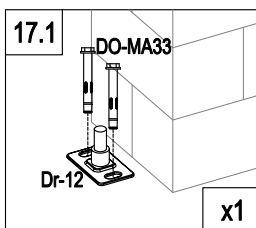

	Dr-12	1
	DO-MA33	2

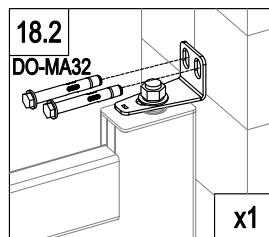
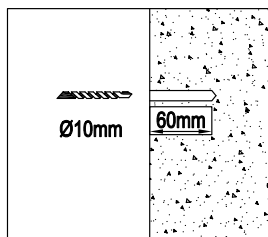
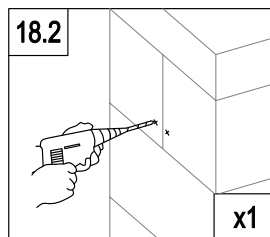
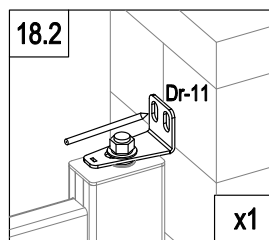
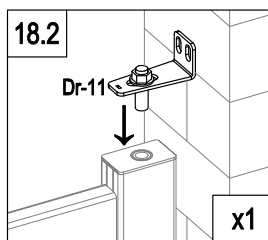
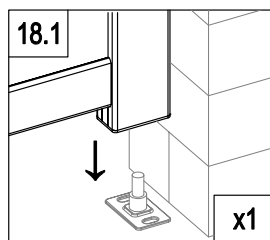
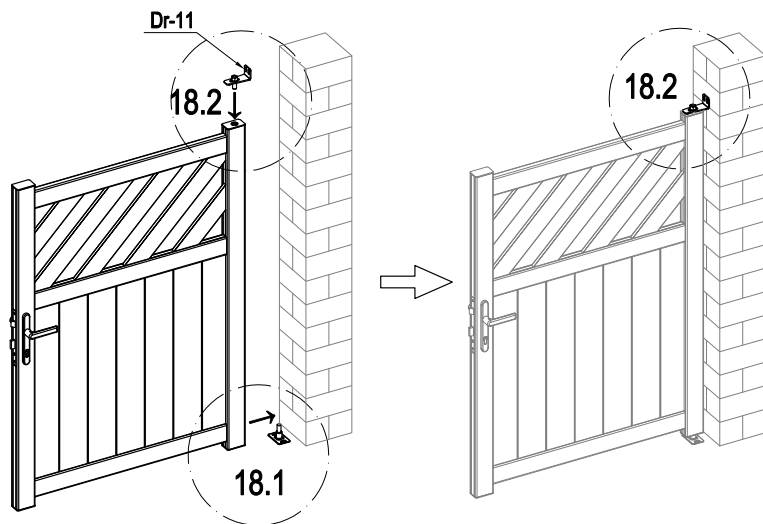





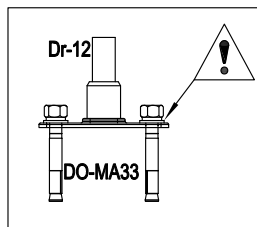
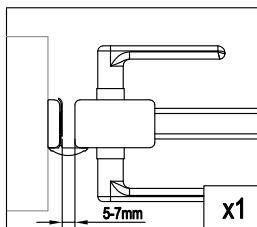
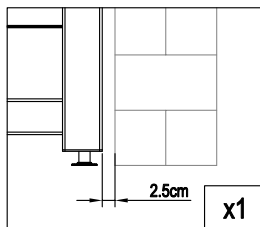
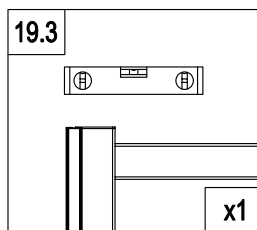
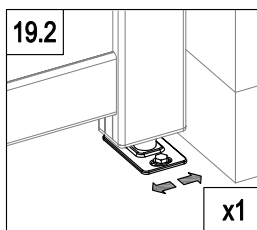
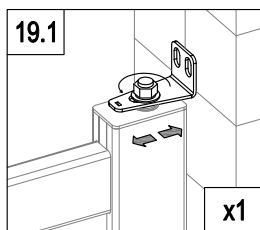
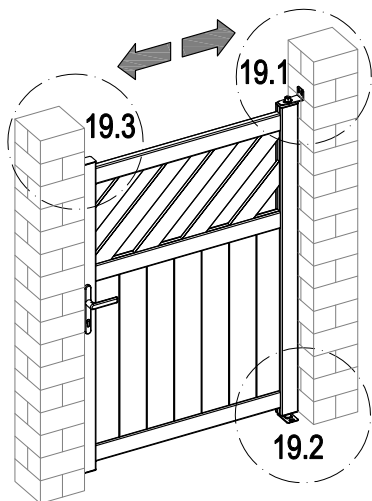

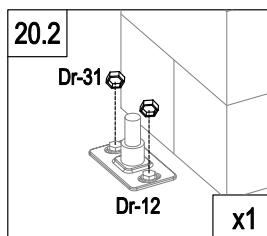
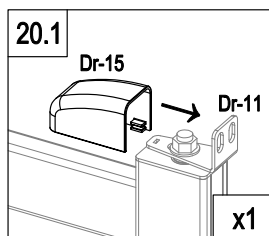
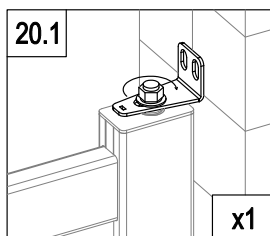
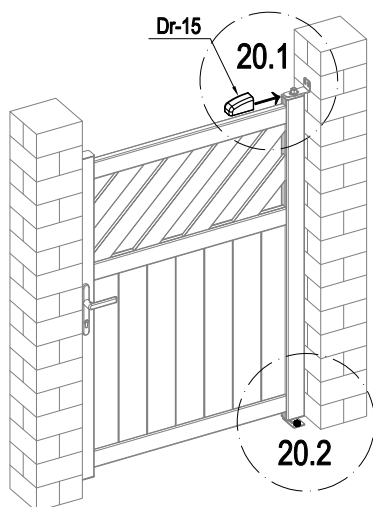
	Dr-11	1
	DO-MA32	2



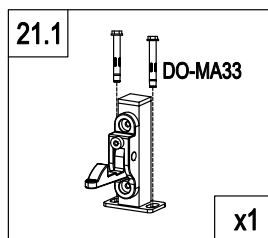
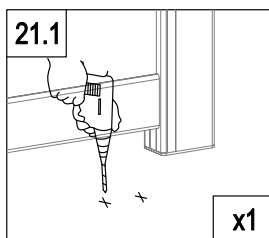
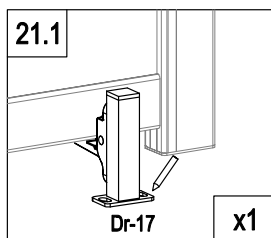
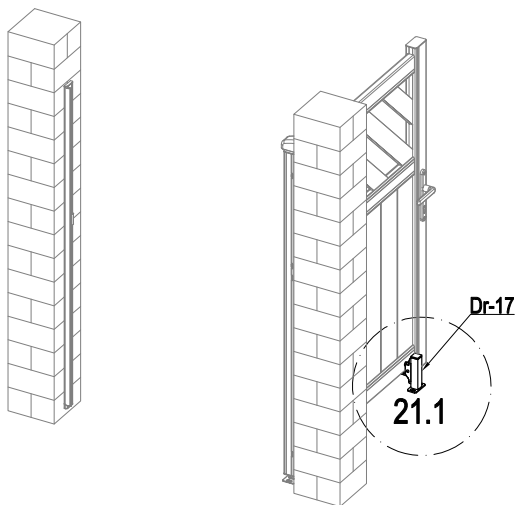

	Dr-15	1
	Dr-31	2



	DO-MA33	2
	Dr-17	1