

# CASANOVO

## OLGA 100P100

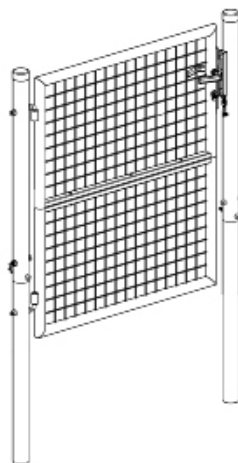

STI-000335 [x1]



30 min









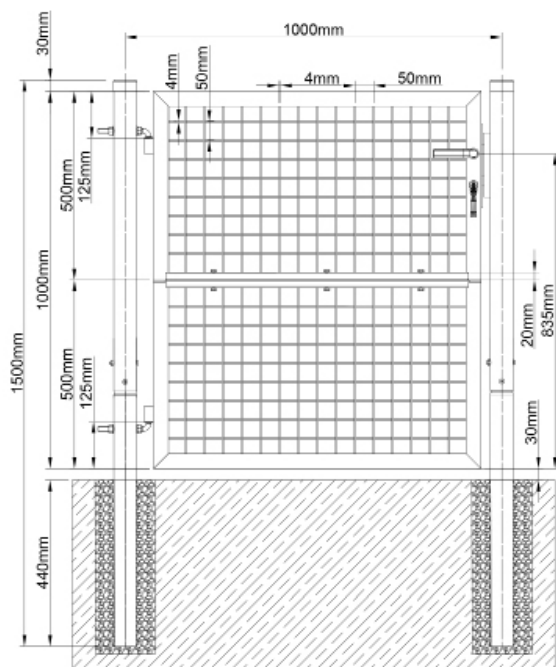

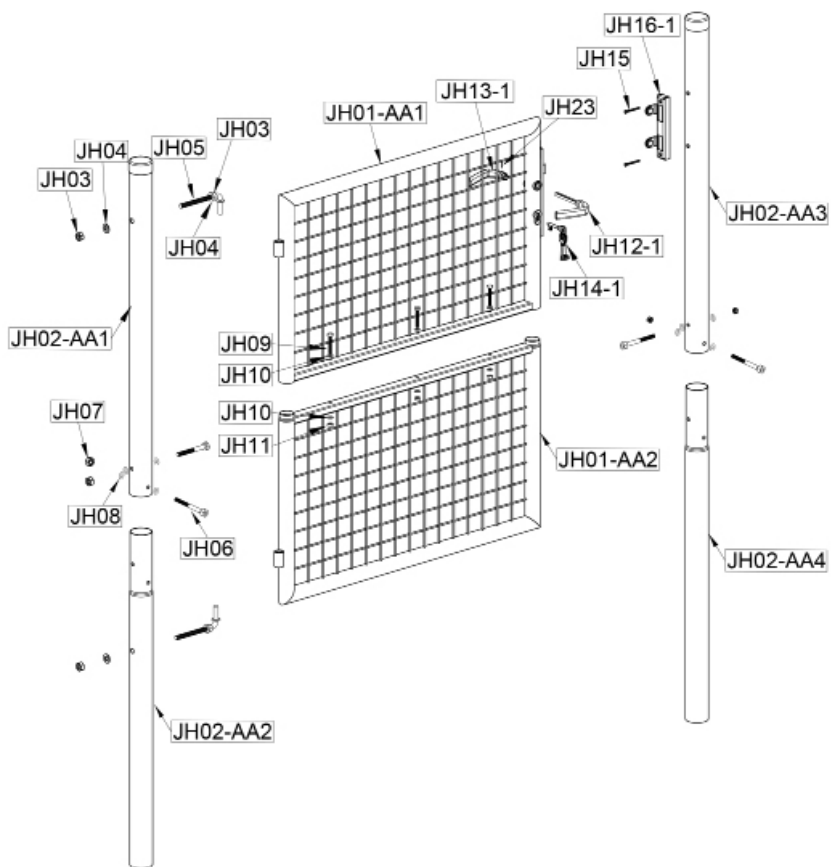













X 1







INSTRUCTION MANUAL / NOTICE DE MONTAGE / MONTAGEANLEITUNG / MANUAL DE MONTAJE / MANUAL DE MONTAGEM / MANUALE DI MONTAGGIO /  
MONTAGEHANDLEIDING / INSTRUKCJA MONTAŻU / KÄYTTÖOHJEET / BRUKSANVISNING / BRUGSANVISNING / INSTRUCIUNI DE ASAMBLARE /  
NAVODILA ZA SESTAVLJANJE / NÁVOD NA MONTÁŽ / ÖSSZESZERELÉSI ÚTMUTATÓ / NÁVOD K MONTÁŽI / UPUTE ZA INSTALACIJU /  
ΟΔΗΓΙΕΣ ΣΥΝΑΡΜΟΛΟΓΗΣΗΣ / SURINKIMO INSTRUKCIJOS / MONTÁŽAS INSTRUKCIJAS



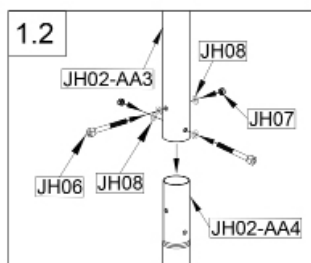
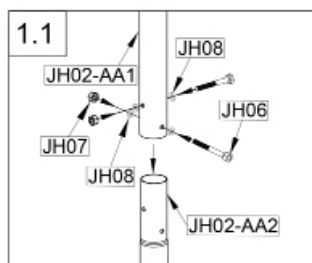
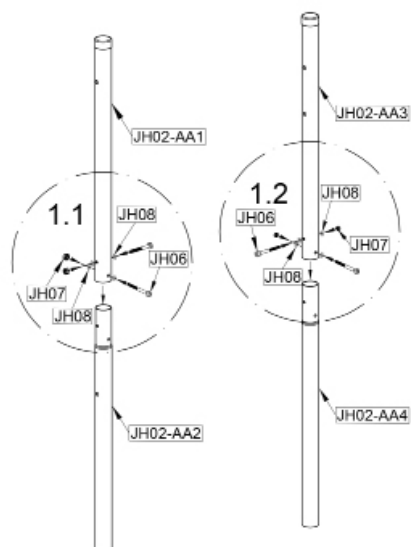

| PICTURES  | REF-PCS  | SIZE        | QUANTITY |
|---|----------|-------------|----------|
|    | JH01-AA1 | 870×500mm   | 1        |
|    | JH01-AA2 | 870×500mm   | 1        |
|    | JH02-AA1 | φ60×825mm   | 1        |
|    | JH02-AA2 | φ60×825mm   | 1        |
|    | JH02-AA3 | φ60×825mm   | 1        |
|    | JH02-AA4 | φ60×825mm   | 1        |
|    | JH03     | 20×10mm     | 4        |
|    | JH04     | 24×1mm      | 4        |
|    | JH05     | 12×120mm    | 2        |
|    | JH06     | 10×70mm     | 4        |
|    | JH07     | 20×7mm      | 4        |
|    | JH08     | 20×1mm      | 8        |
|  | JH09     | 8×55mm      | 3        |
|  | JH10     | 17×1mm      | 6        |
|  | JH11     | 15×5mm      | 3        |
|  | JH12-1   | 16×95×110mm | 1        |
|  | JH13-1   | 16×34×110mm | 1        |
|  | JH14-1   | 6×70mm      | 3        |
|  | JH15     | 6×35mm      | 2        |
|  | JH16-1   | 30×173mm    | 1        |
|  | JH23     | 2×19mm      | 1        |



| Thumbnails  | No.  | Size    | Quantity |
|---|------|---------|----------|
|  | JH06 | 10x70mm | 4        |
|  | JH07 | 20x7mm  | 4        |
|  | JH08 | 20x1mm  | 8        |

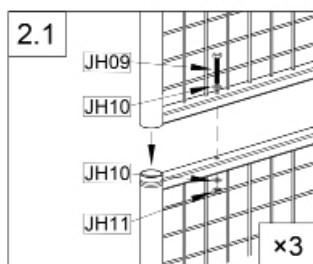
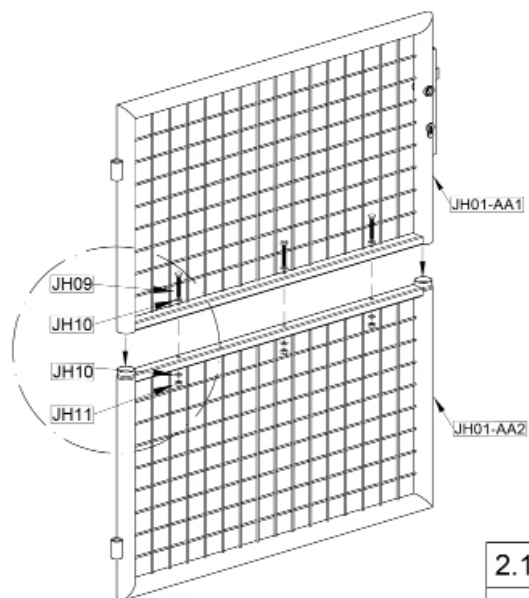

| Thumbnails | No.  | Size   | Quantity |
|------------|------|--------|----------|
|            | JH09 | 8×55mm | 3        |
|            | JH10 | 17×1mm | 6        |
|            | JH11 | 15×5mm | 3        |

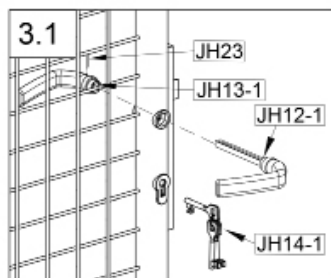
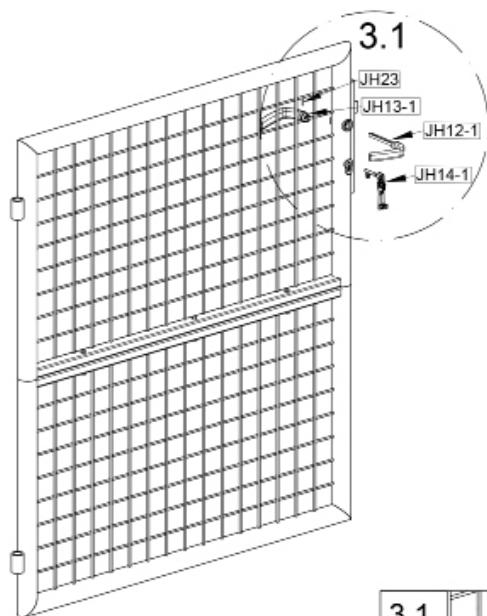

| Thumbnails | No.    | Size        | Quantity |
|------------|--------|-------------|----------|
|            | JH12-1 | 16×95×110mm | 1        |
|            | JH13-1 | 16×34×110mm | 1        |
|            | JH14-1 | 6×70mm      | 3        |
|            | JH23   | 2×19mm      | 1        |

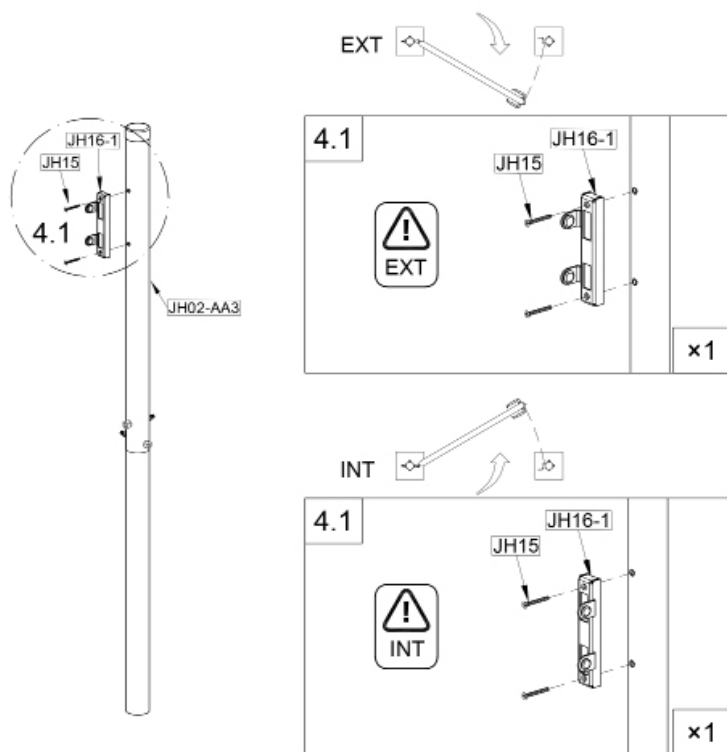

| Thumbnails  | No.    | Size     | Quantity |
|---|--------|----------|----------|
| -   | JH15   | 6×35mm   | 2        |
|  | JH16-1 | 30×173mm | 1        |



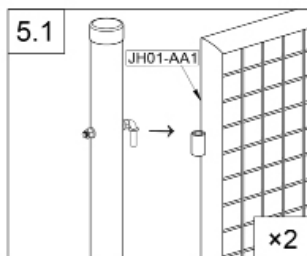
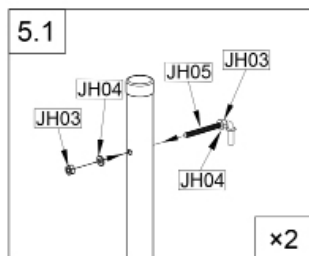
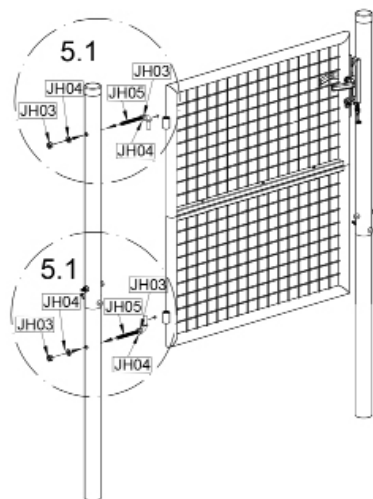

| Thumbnails | No.  | Size     | Quantity |
|------------|------|----------|----------|
|            | JH03 | 20×10mm  | 4        |
|            | JH04 | 24×1mm   | 4        |
|            | JH05 | 12×120mm | 2        |

