

CASANOVO

VOGEL 100P160

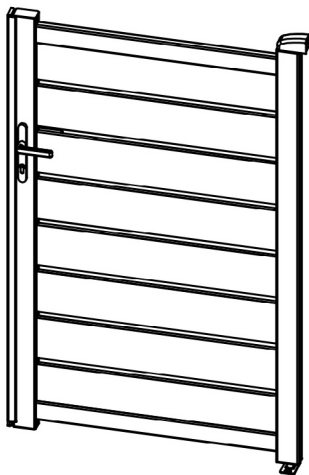

COM-000245 [x1]





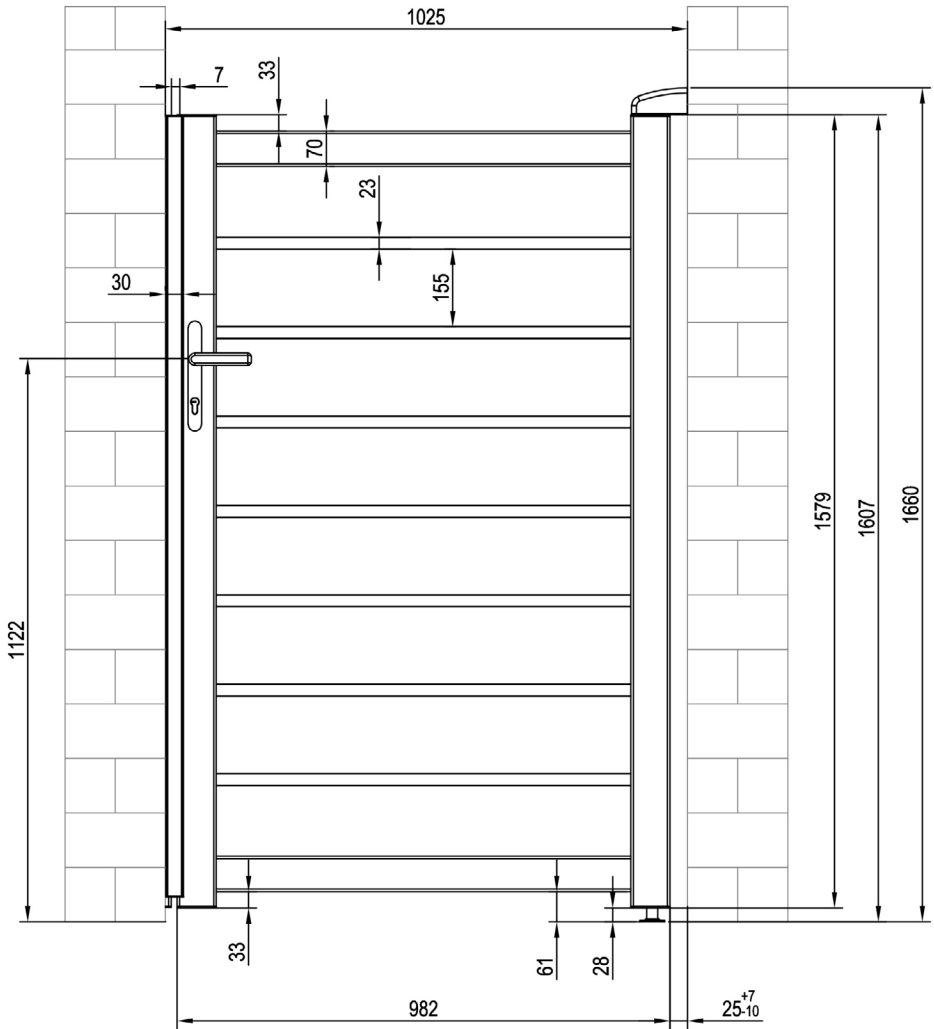

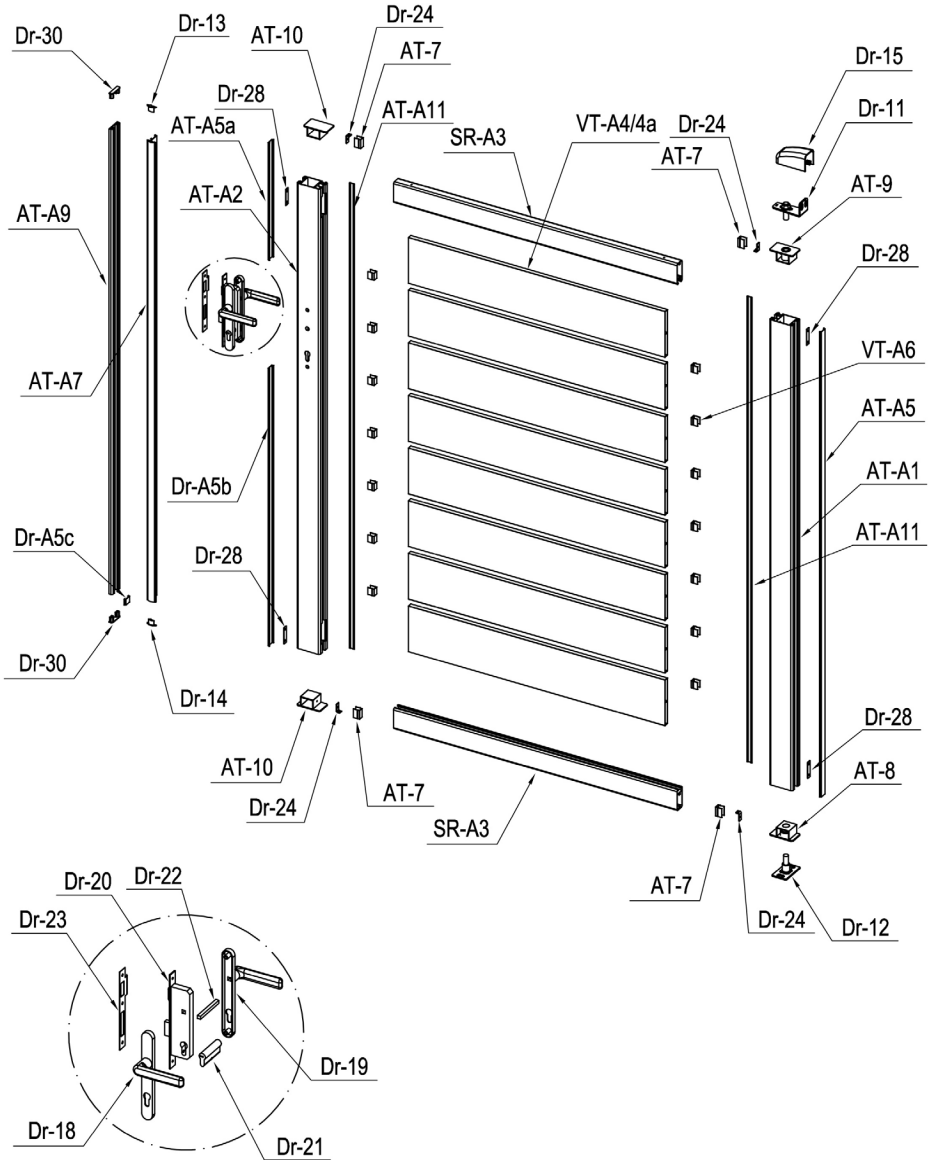































INSTRUCTION MANUAL / NOTICE DE MONTAGE / MONTAGEANLEITUNG / MANUAL DE MONTAJE / MANUAL DE MONTAGEM / MANUALE DI MONTAGGIO /
MONTAGEHANDLEIDING / INSTRUKCJA MONTAŻU / KÄYTTÖOHJEET / BRUKSANVISNING / BRUGSANVISNING / INSTRUCȚIUNI DE ASAMBLARE /
NAVODILA ZA SESTAVLJANJE / NÁVOD NA MONTÁŽ / ÖSSZESZERELÉSI ÚTMUTATÓ / NÁVOD K MONTÁŽI / UPUTE ZA INSTALACIJU /
ΟΔΗΓΙΕΣ ΣΥΝΑΡΜΟΛΟΓΗΣΗΣ / SURINKIMO INSTRUKCIJOS / MONTĀŽAS INSTRUKCIJAS







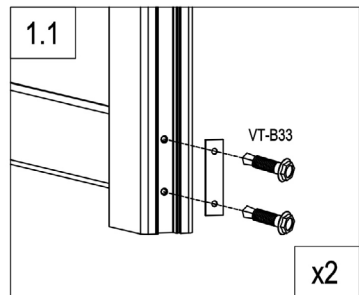
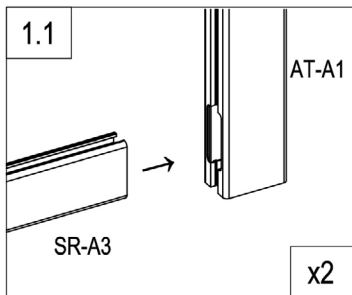
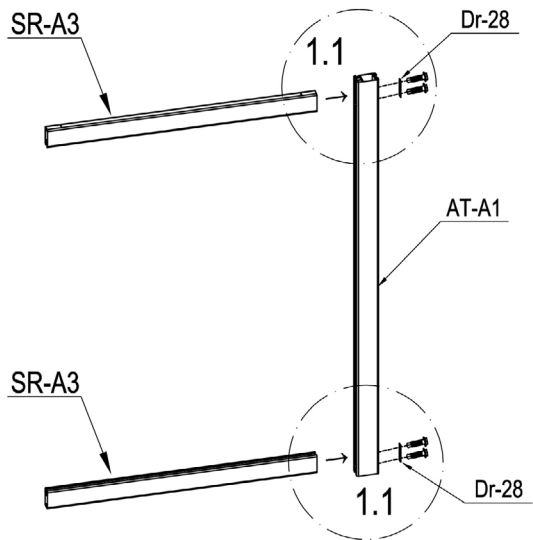

PART LIST

IMAGE	NO.	L.(mm)	QTY	IMAGE	NO.	L.(mm)	QTY
	AT-A1	1573	1		Dr-15		1
	AT-A2	1573	1		Dr-17		1
	AT-A9	1573	1		Dr-30		2
	SR-A3	959	2		Dr-31		2
	VT-A4	868	7		Dr-18		1
	VT-A4a (+SR-A15)	868	1		Dr-19		1
	AT-A5	1573	1		Dr-21		1
	AT-A5a	395.5	1		Dr-22		1
	Dr-A5b	937	1		Dr-23		1
	Dr-A5c	19.5	1		Dr-24		4
	AT-A11	1573	2		Dr-25		1
	VT-A6	23	14		Dr-25a		2
	AT-7	29.5	4		Dr-26		3
	AT-A7	1553	1		Dr-27		2
	AT-8		1		VT-B30		4
	AT-9		1		VT-B31		4
	AT-10		2		VT-B32		6
	Dr-11		1		VT-B33		8
	Dr-12		1		VT-B34		3
	Dr-13		1		VT-B35		32
	Dr-14		1		Dr-28		4



	AT-A1	1
	SR-A3	2
	Dr-28	2
	VT-B33	4

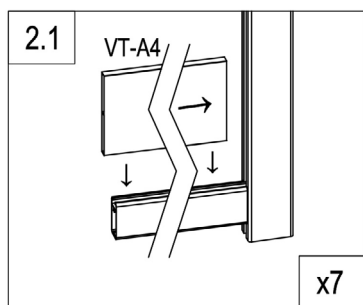
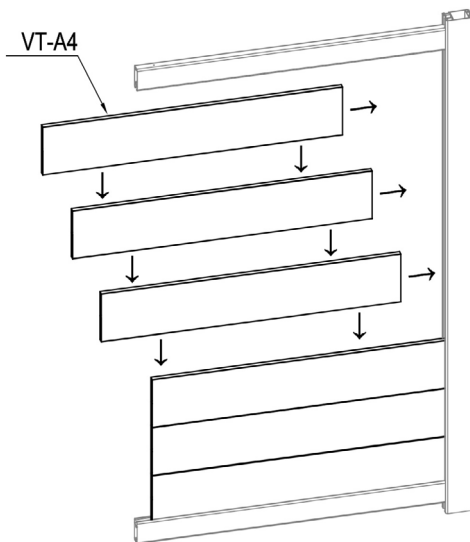

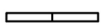
	VT-A4	7
---	-------	---

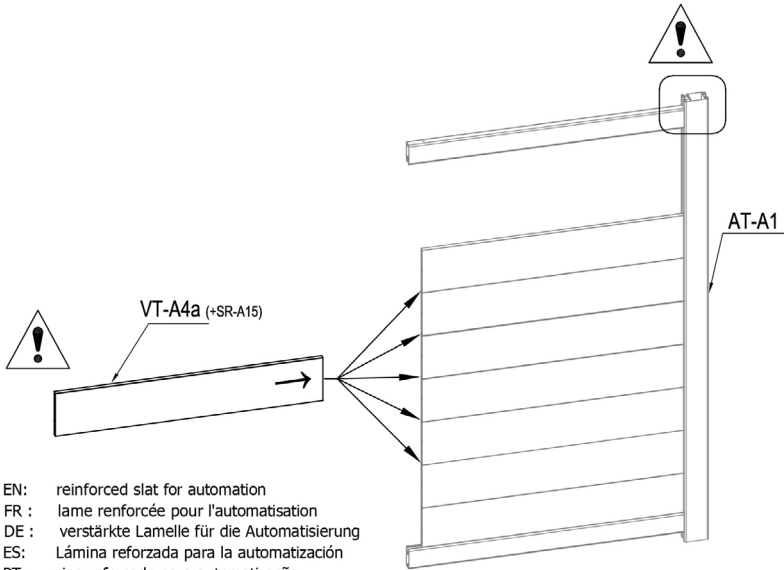

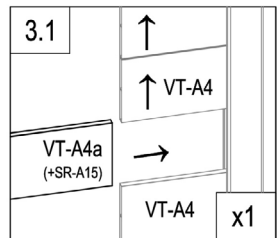
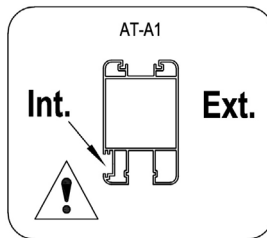
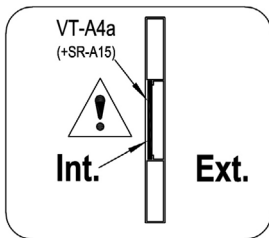

- EN: reinforced slat for automation
- FR : lame renforcée pour l'automatisation
- DE : verstärkte Lamelle für die Automatisierung
- ES: Lámina reforzada para la automatización
- PT: ripa reforçada para automatização
- IT: lamella rinforzata per l'automazione
- NL: versterkte lat voor automatisering
- PL: wzmocniona listwa do automatyzacji

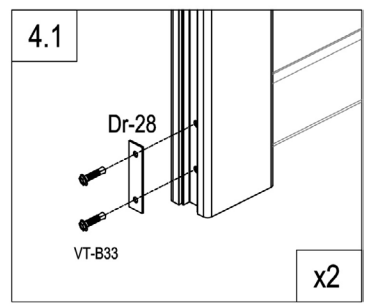
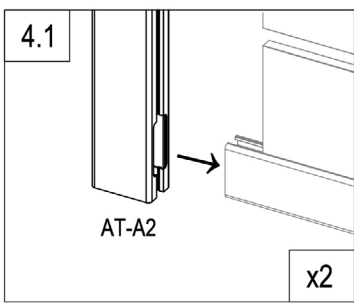
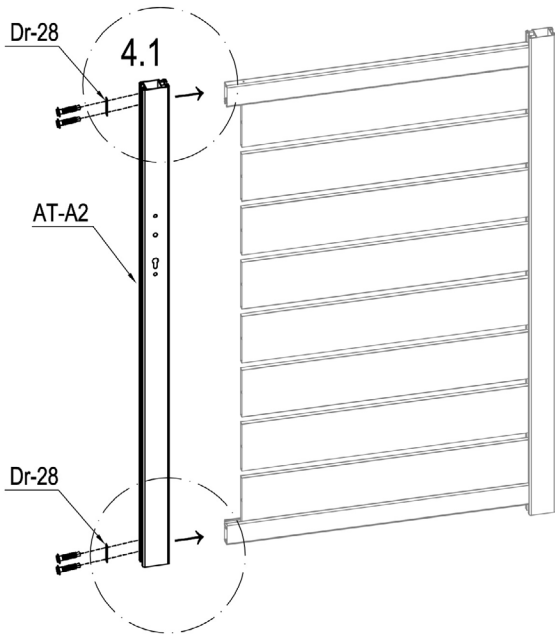

	VT-A4a (+SR-A15)	1
--	------------------	---



	AT-A2	1
	Dr-28	2
	VT-B33	4

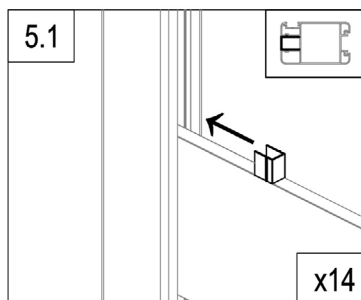
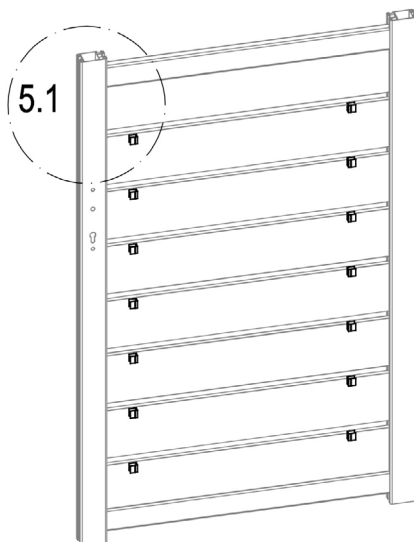

	VT-A6	14
---	-------	----

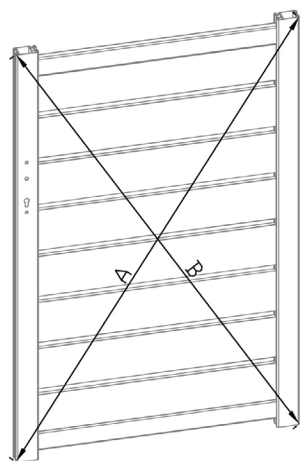

A=B

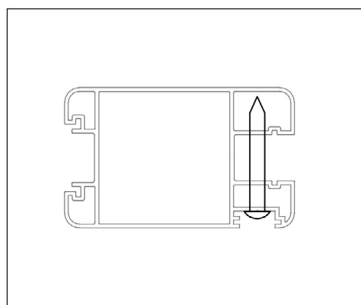
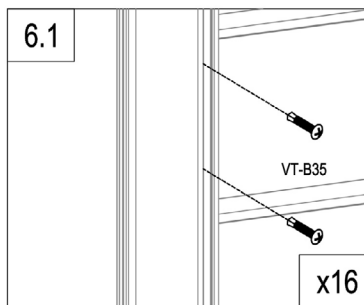
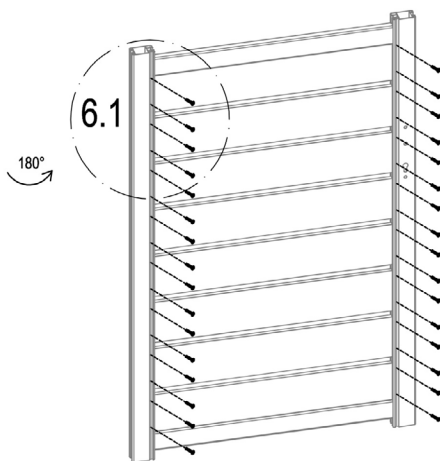

	VT-B35	32
---	--------	----

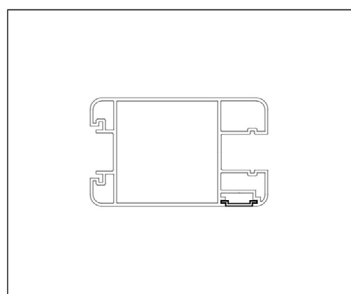
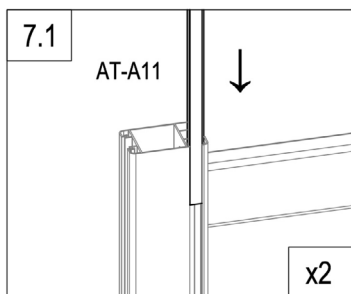
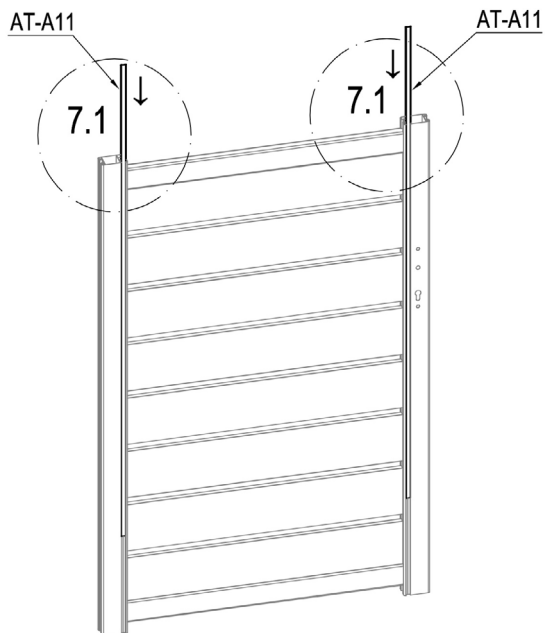

	AT-A11	2
---	--------	---

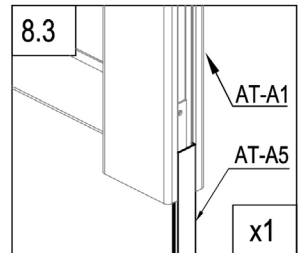
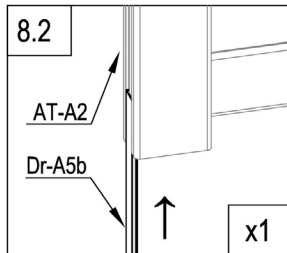
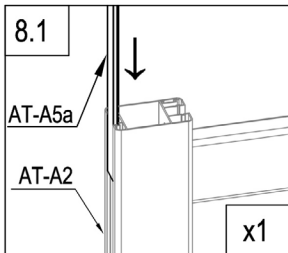
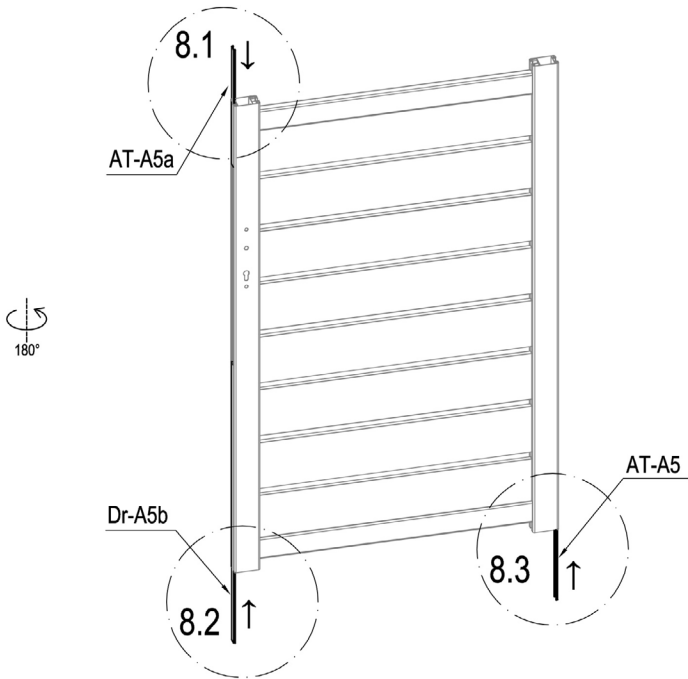

	AT-A5a	1
	Dr-A5b	1
	AT-A5	1

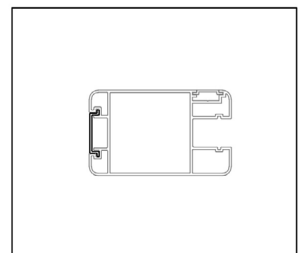

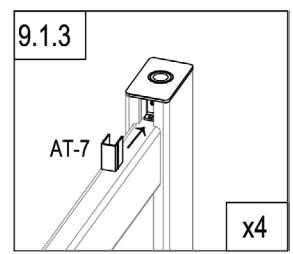
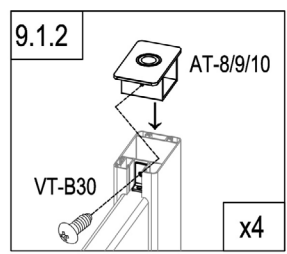
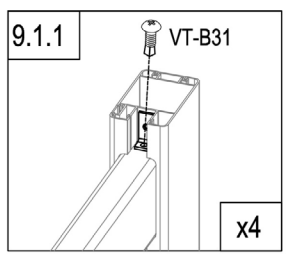
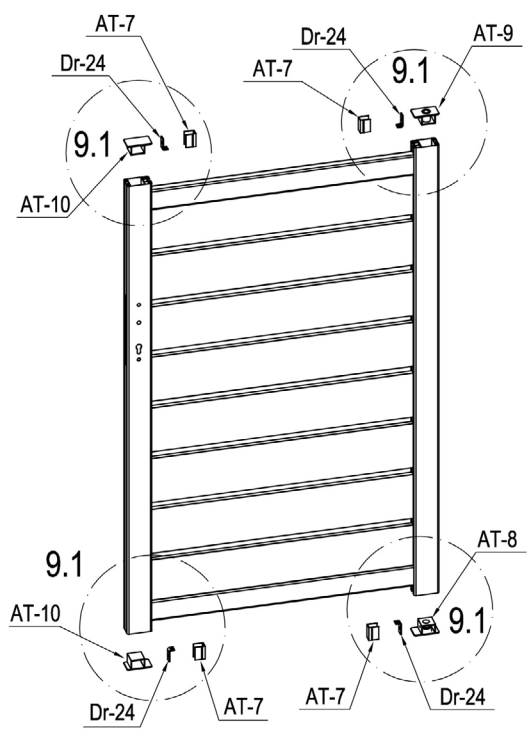

	AT-8	1
	AT-9	1
	AT-10	2
	AT-7	4

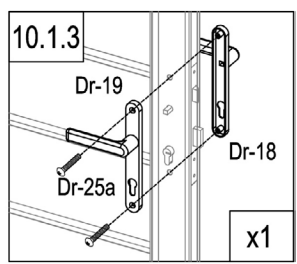
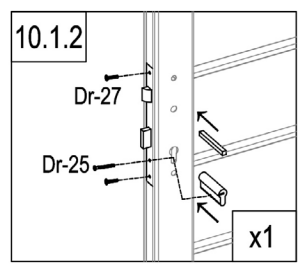
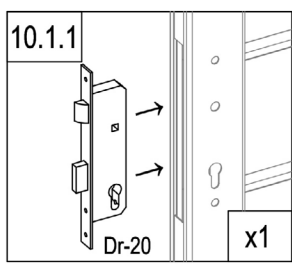
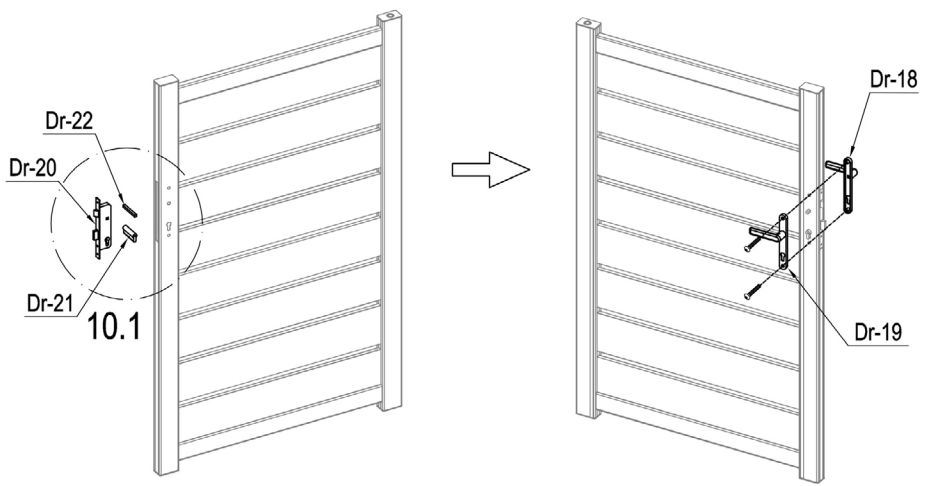

	Dr-24	4
	VT-B30	4
	VT-B31	4

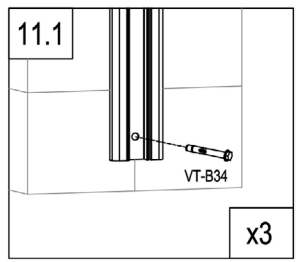
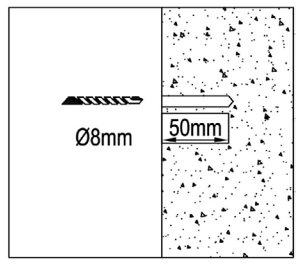
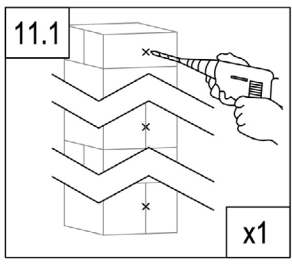
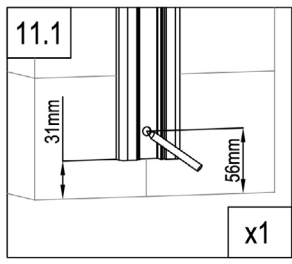
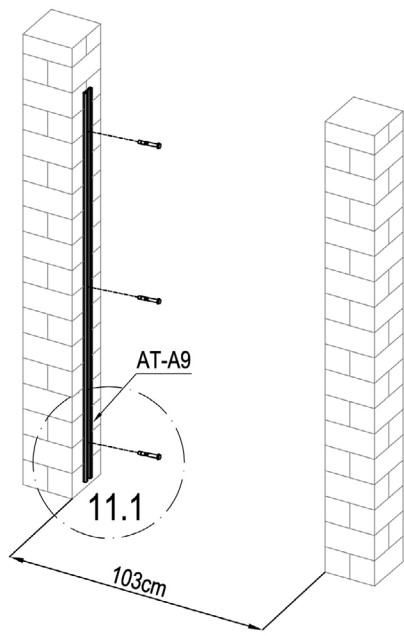

	Dr-20	1
	Dr-21	1
	Dr-22	1
	Dr-25	1

	Dr-18	1
	Dr-19	1
	Dr-25a	2
	Dr-27	2



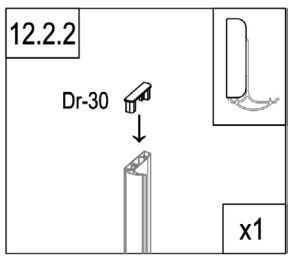
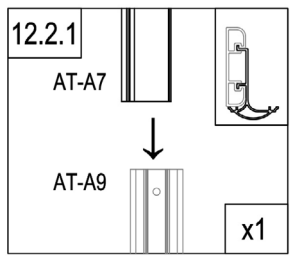
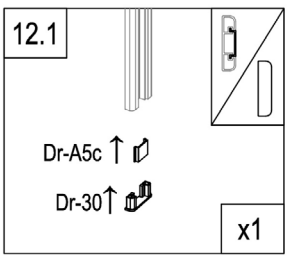
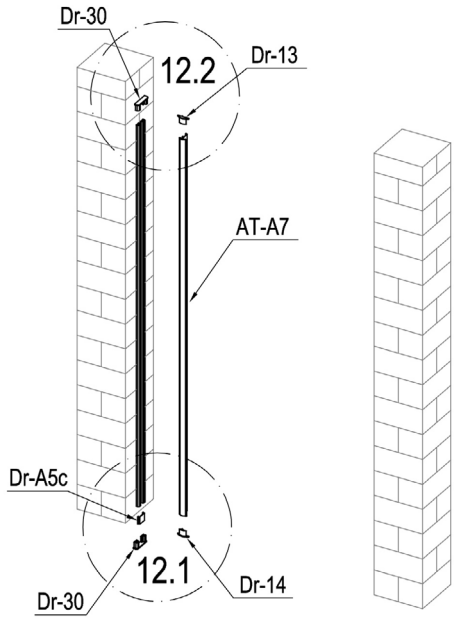

	AT-A9	1
	VT-B34	3



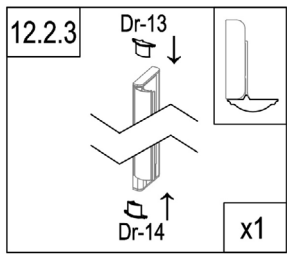

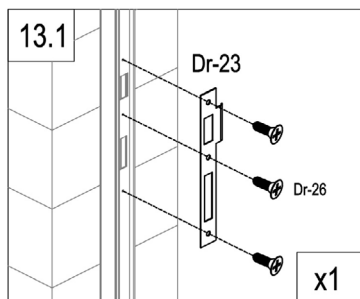
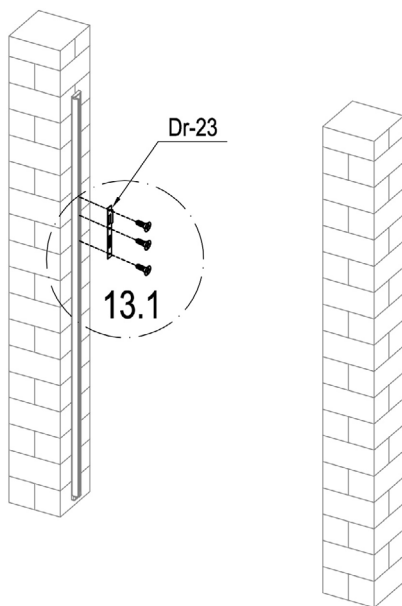
	AT-A7	1
	Dr-13	1
	Dr-14	1
	Dr-30	2
	Dr-A5c	1





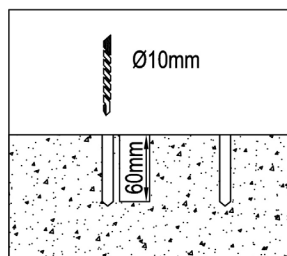
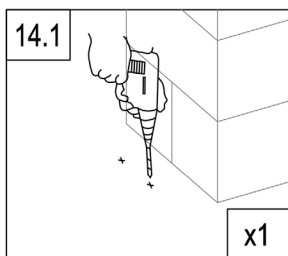
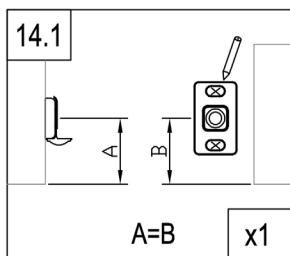
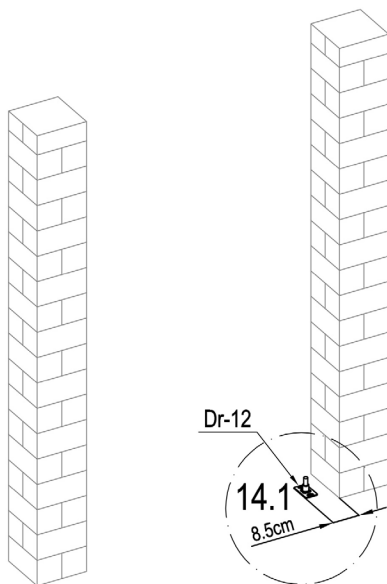

	Dr-23	1
	Dr-26	3

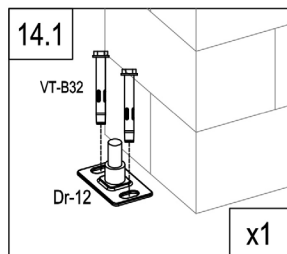

	Dr-12	1
	VT-B32	2

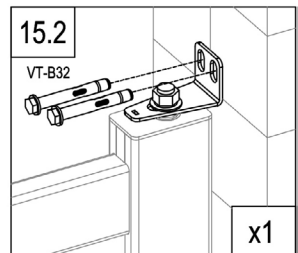
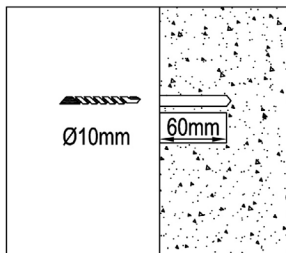
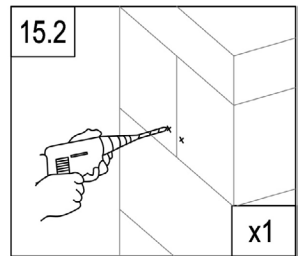
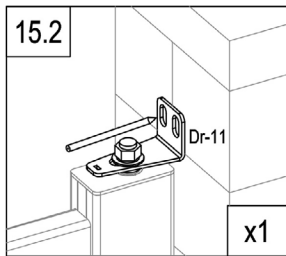
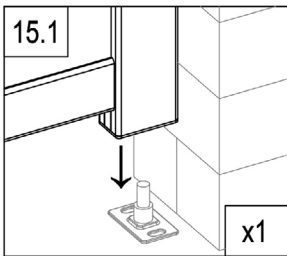
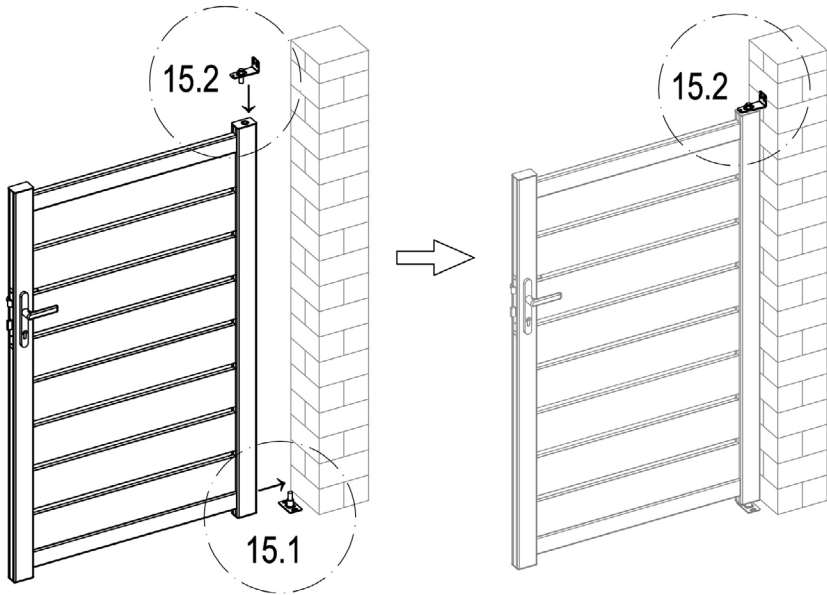





	Dr-11	1
	VT-B32	2

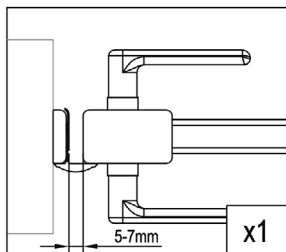
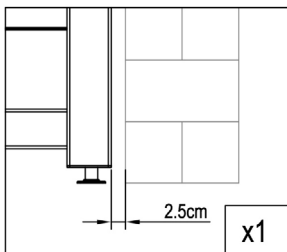
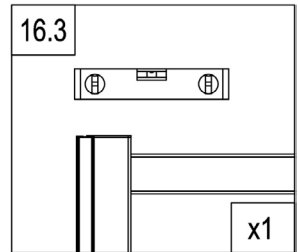
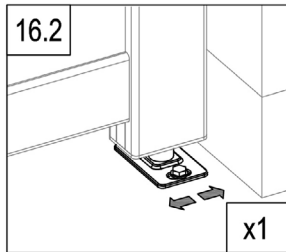
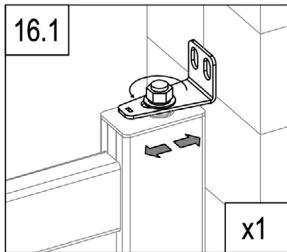
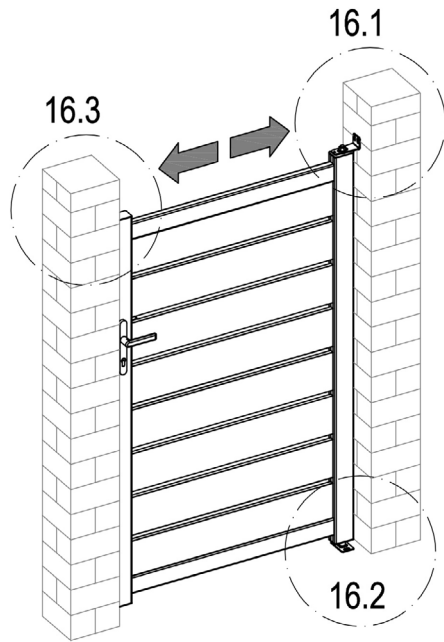

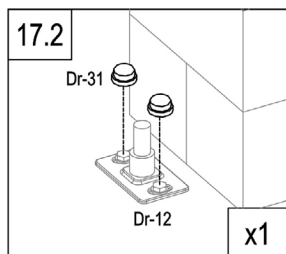
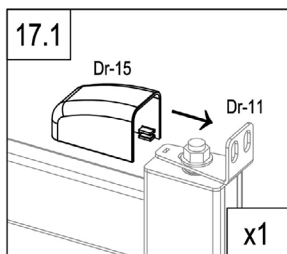
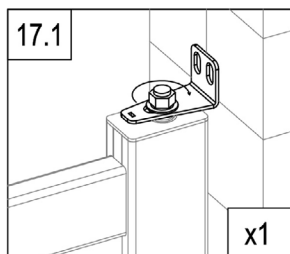
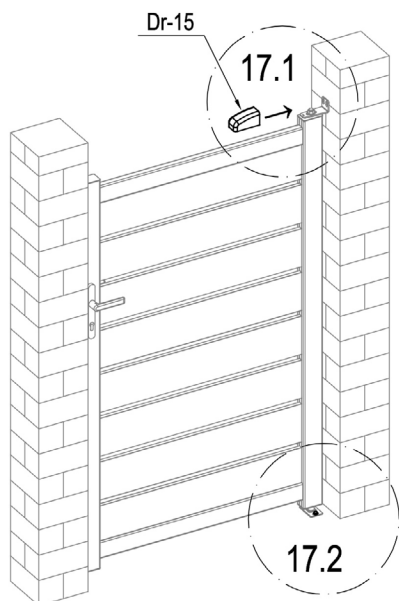
CASANOVO



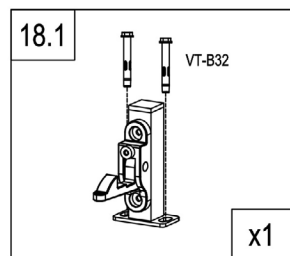
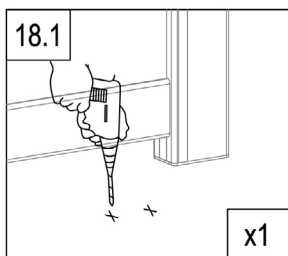
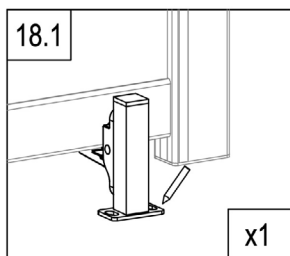
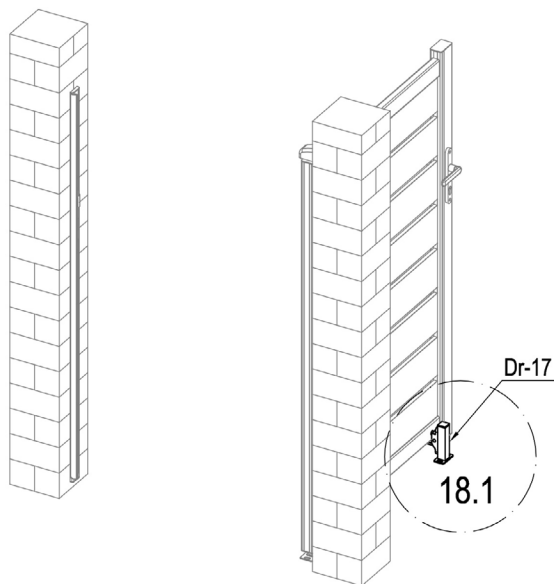

	Dr-15	1
	Dr-31	2



	VT-B32	2
	Dr-17	1