

CASANOVO

CARPATIA 100P140

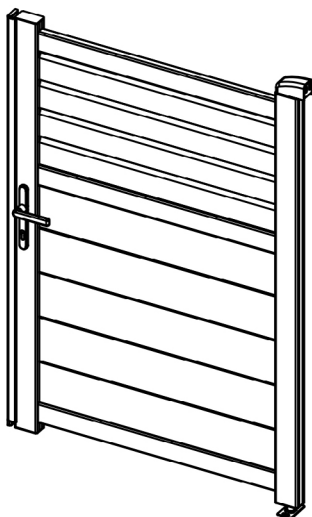

STI-000246 [x1]



3-5H



X 2





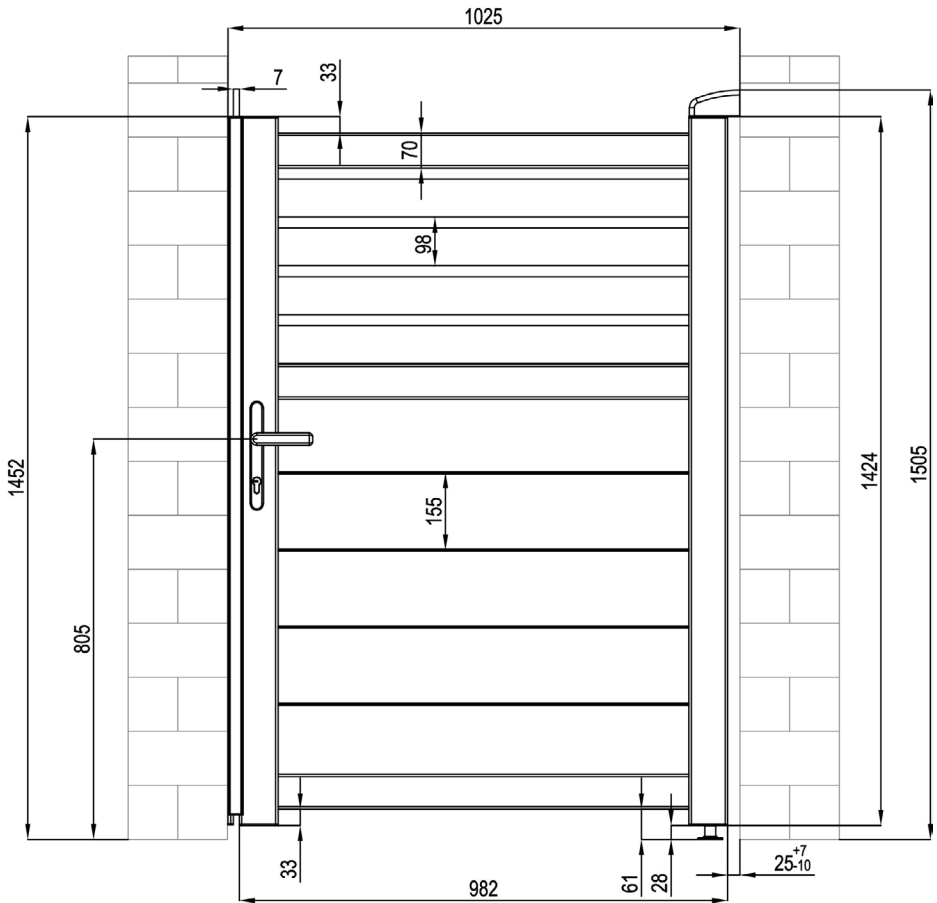

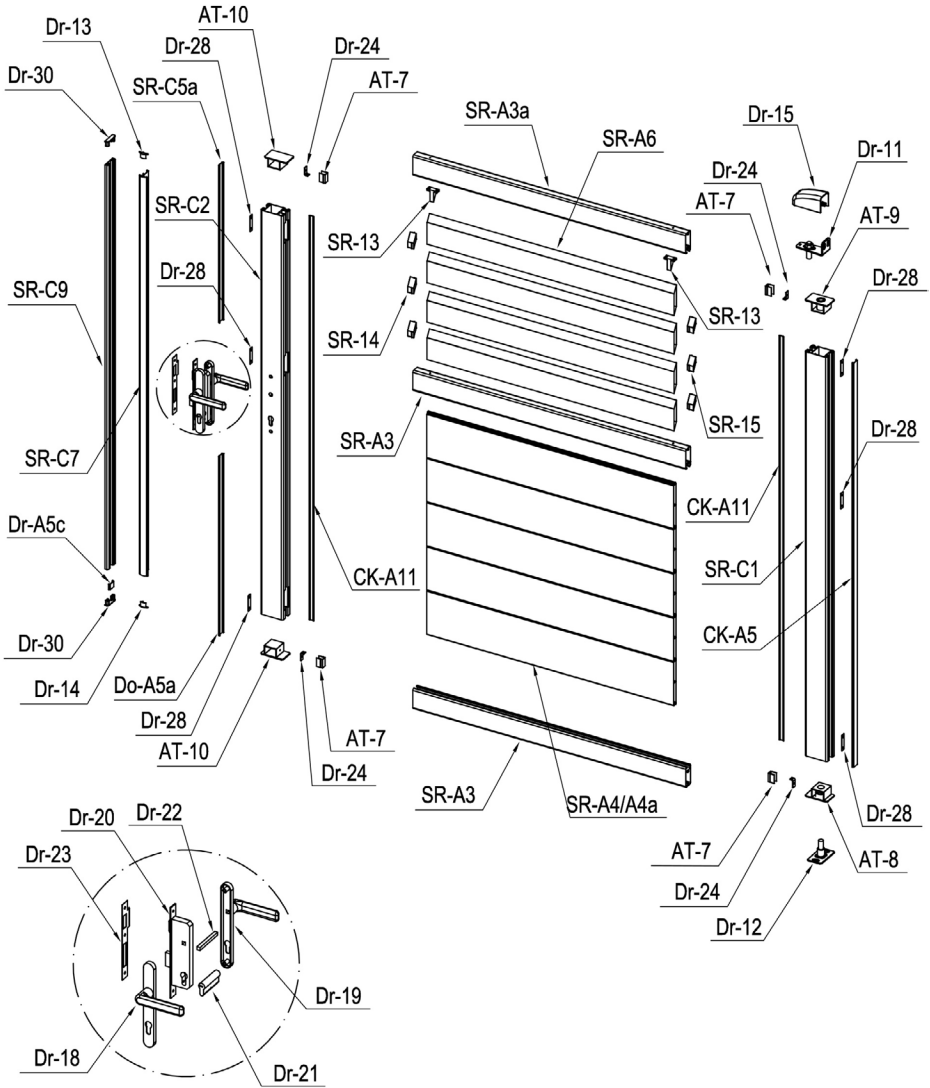





































INSTRUCTION MANUAL / NOTICE DE MONTAGE / MONTAGEANLEITUNG / MANUAL DE MONTAJE / MANUAL DE MONTAGEM / MANUALE DI MONTAGGIO /
MONTAGEHANDLEIDING / INSTRUKCJA MONTAŻU / KÄYTTÖOHJEET / BRUKSANVISNING / BRUGSANVISNING / INSTRUCȚIUNI DE ASAMBLARE /
NAVODILA ZA SESTAVLJANJE / NÁVOD NA MONTÁŽ / ÖSSZESZERELÉSI ÚTMUTATÓ / NÁVOD K MONTÁŽI / UPUTE ZA INSTALACIJU /
ΟΔΗΓΙΕΣ ΣΥΝΑΡΜΟΛΟΓΗΣΗΣ / SURINKIMO INSTRUKCIJOS / MONTĀŽAS INSTRUKCIJAS





CASANOVO

IMAGE	NO.	L.(mm)	QTY	IMAGE	NO.	L.(mm)	QTY
	SR-C1	1418	1		SR-14		3
	SR-C2	1418	1		SR-15		3
	SR-C9	1418	1		Dr-15		1
	SR-A3	959	2		Dr-17		1
	SR-A3a	959	1		Dr-30		2
	SR-A4	868	4		Dr-31		2
	SR-A4a (+SR-A15)	868	1		Dr-18		1
	SR-A6	868	4		Dr-19		1
	CK-A5	1418	1		Dr-20		1
	SR-C5a	555.5	1		Dr-21		1
	Do-A5a	622	1		Dr-22		1
	Dr-A5c	19.5	1		Dr-23		1
	CK-A11	1418	2		Dr-25		1
	AT-7	29.5	4		Dr-25a		2
	SR-C7	1398	1		Dr-26		3
	AT-8		1		Dr-27		2
	AT-9		1		Dr-24		4
	AT-10		2		Dr-28		6
	Dr-11		1		SR-Q30	ST4x10	4
	Dr-12		1		SR-Q31	ST4.2x13	8
	Dr-13		1		SR-Q32	M10x60	6
	Dr-14		1		SR-Q33	ST5.5x38	12
	SR-13		2		SR-Q34	M8x50	3
					SR-Q35	ST4.8x38	28

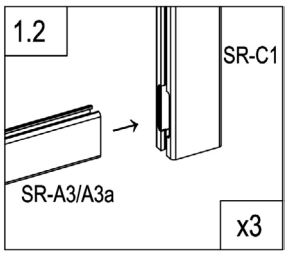
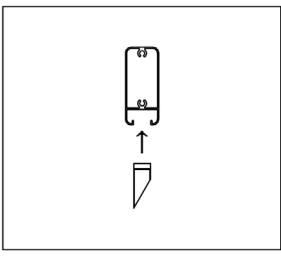
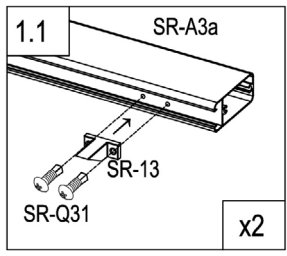
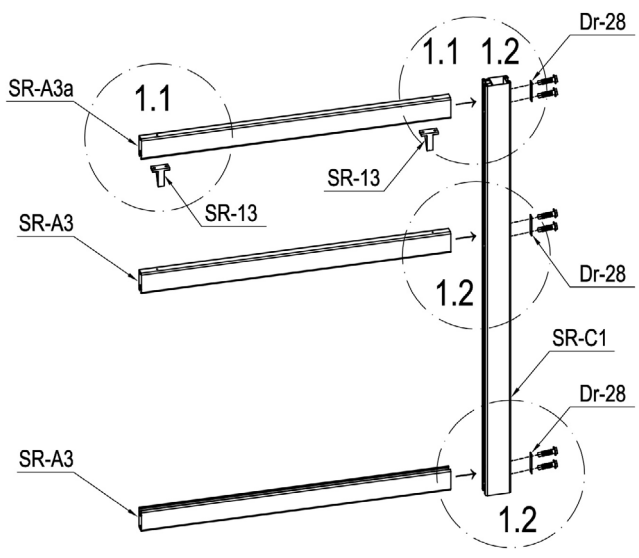

	SR-C1	1
	SR-A3	2
	SR-A3a	1
	SR-13	2

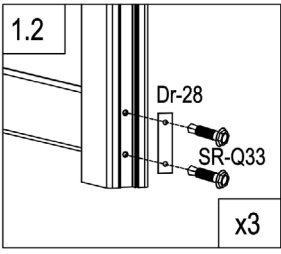

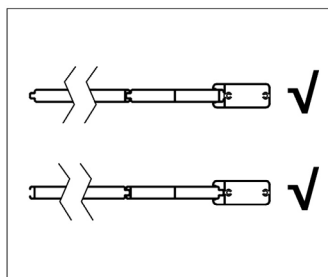
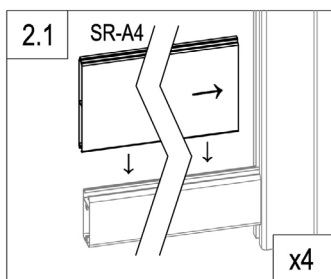
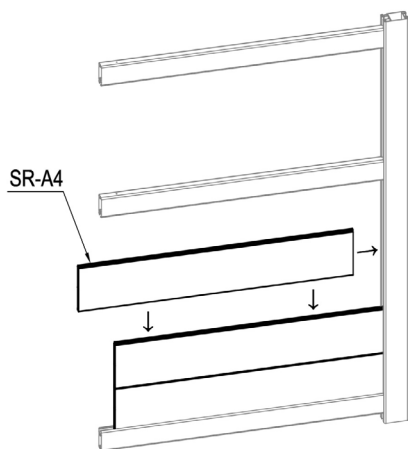

	Dr-28	3
	SR-Q31	4
	SR-Q33	6



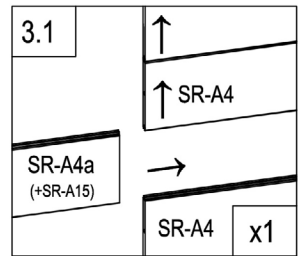
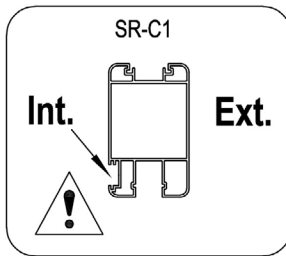
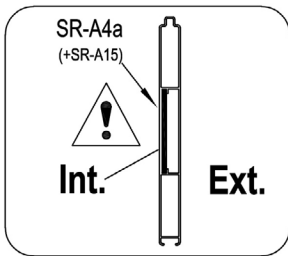
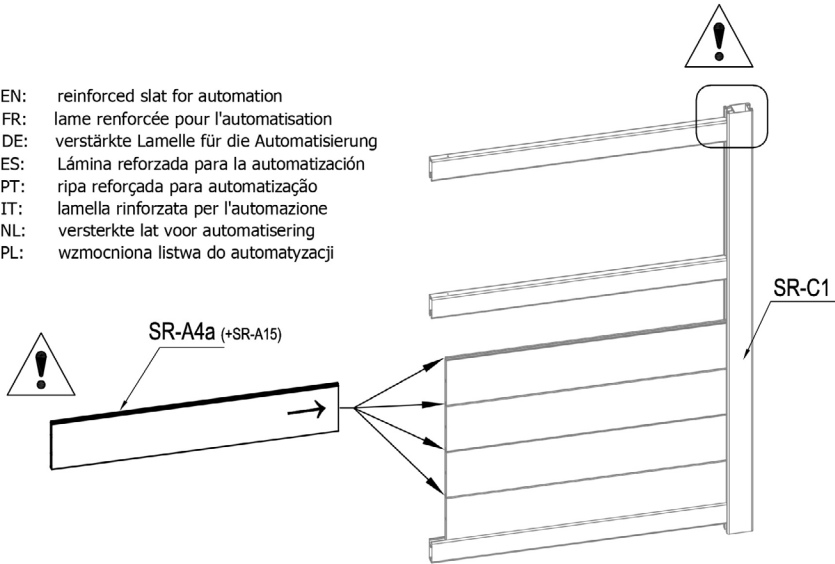

	SR-A4	4
---	-------	---

- EN: reinforced slat for automation
- FR: lame renforcée pour l'automatisation
- DE: verstärkte Lamelle für die Automatisierung
- ES: Lámina reforzada para la automatización
- PT: ripa reforçada para automatização
- IT: lamella rinforzata per l'automazione
- NL: versterkte lat voor automatisering
- PL: wzmocniona listwa do automatyzacji



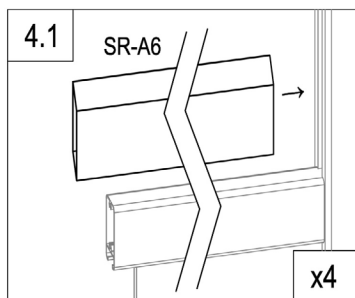
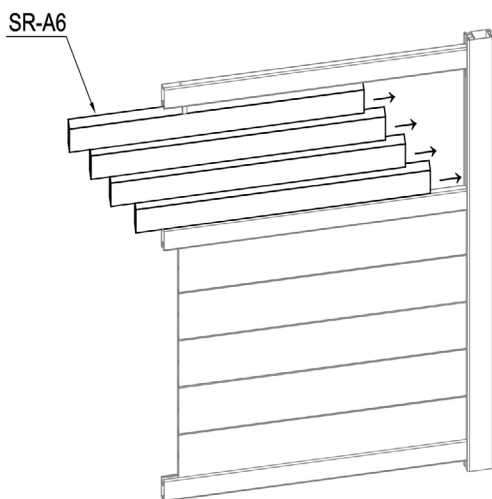

	SR-A4a (+SR-A15)	1
---	------------------	---



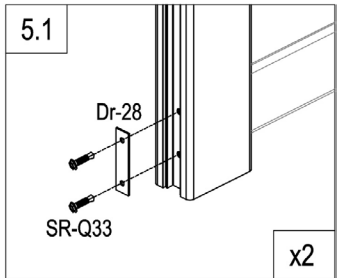
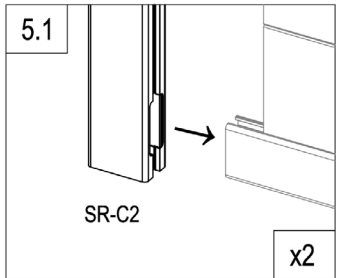
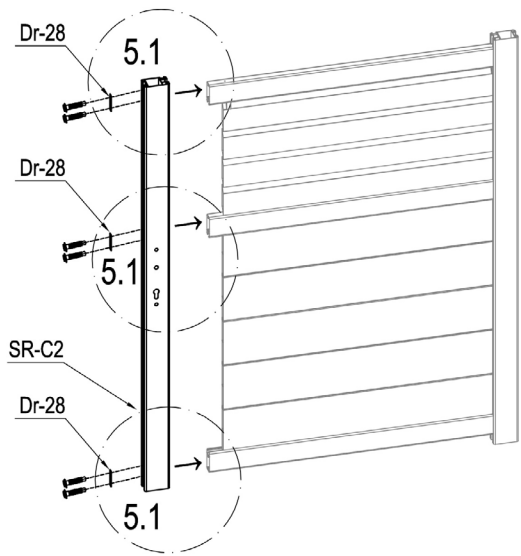

	SR-A6	4
---	-------	---

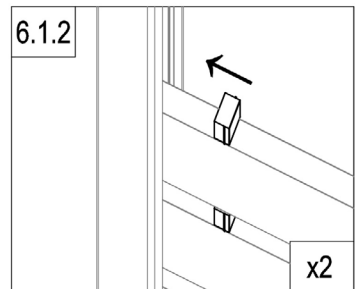
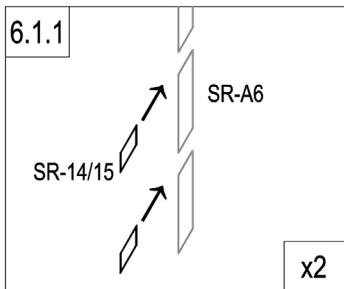
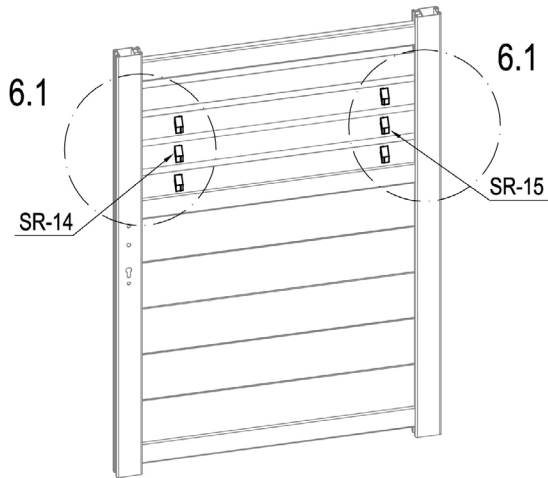

	SR-C2	1
	Dr-28	3
	SR-Q33	6



	SR-14	3
	SR-15	3

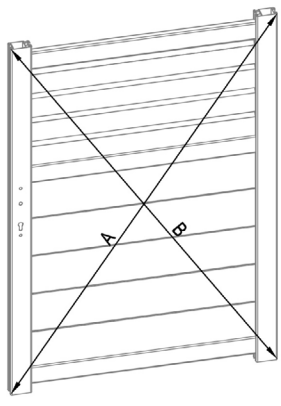

A=B

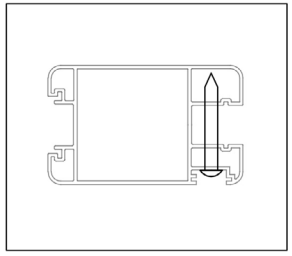
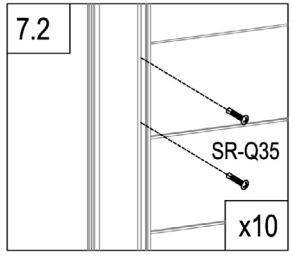
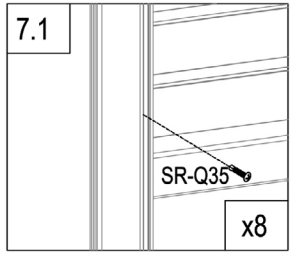
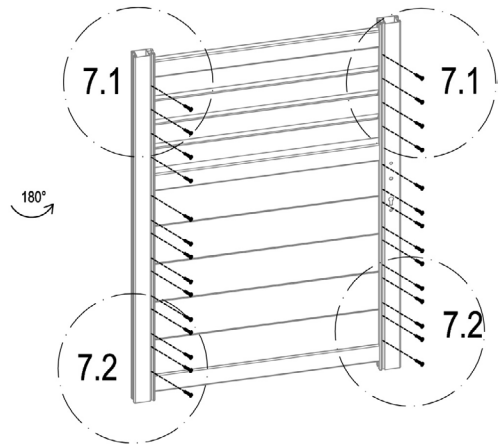

	SR-Q35	28
---	--------	----

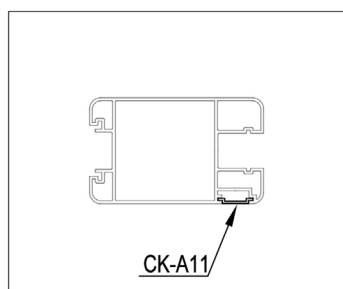
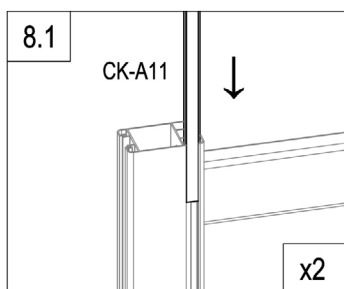
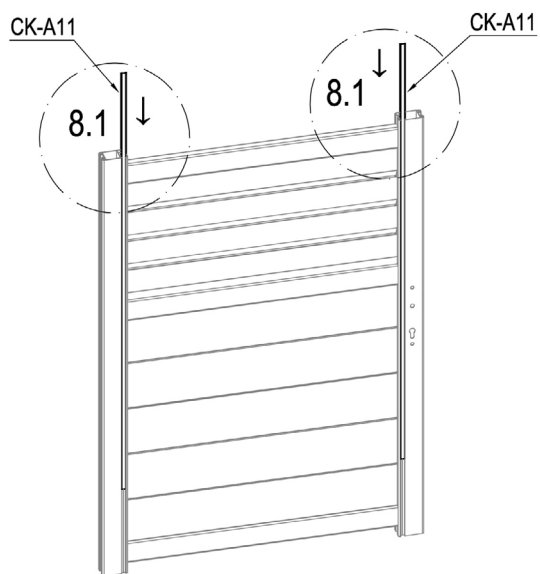

	CK-A11	2
---	--------	---

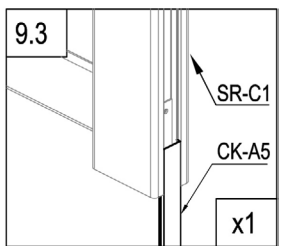
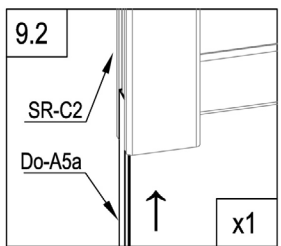
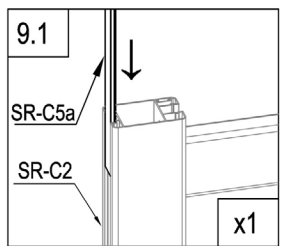
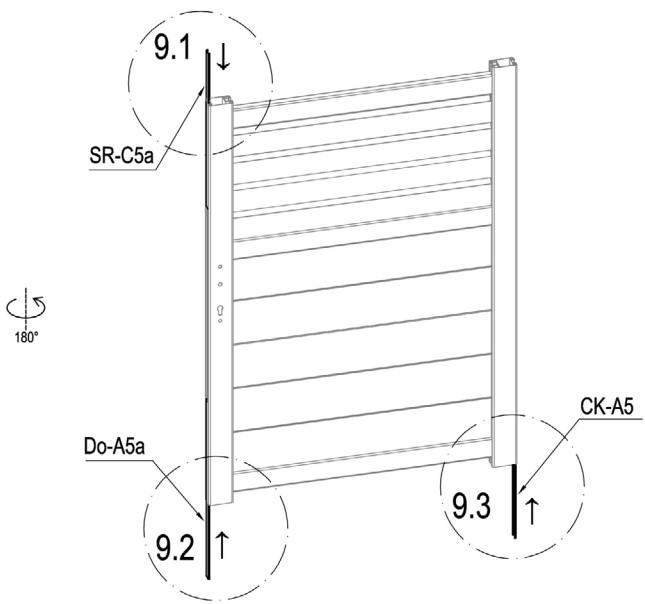

	CK-A5	1
	SR-C5a	1
	Do-A5a	1

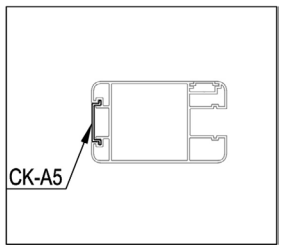

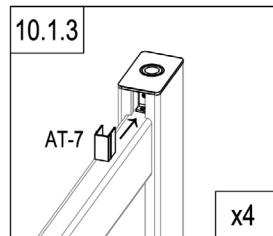
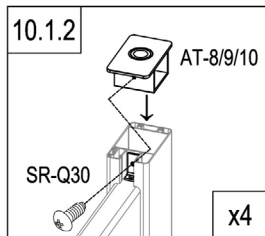
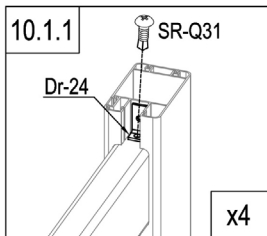
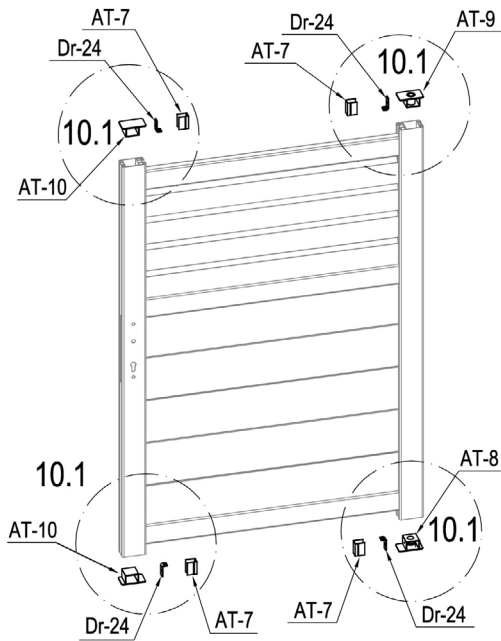

	AT-8	1
	AT-9	1
	AT-10	2
	Dr-24	4

	AT-7	4
	SR-Q30	4
	SR-Q31	4

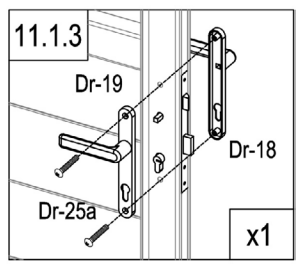
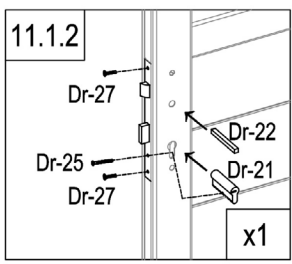
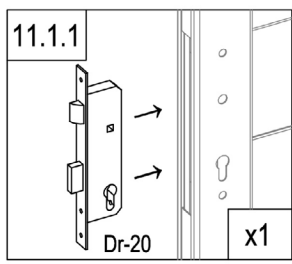
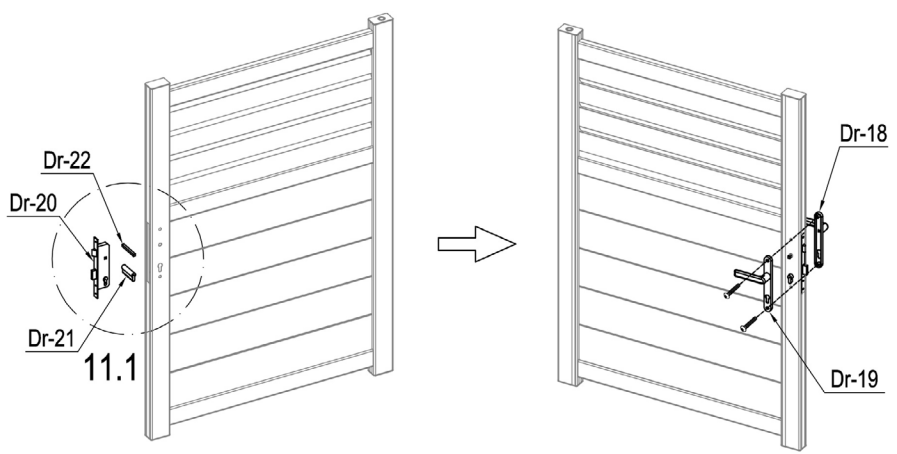



	Dr-20	1
	Dr-21	1
	Dr-22	1
	Dr-25	1

	Dr-18	1
	Dr-19	1
	Dr-25a	2
	Dr-27	2

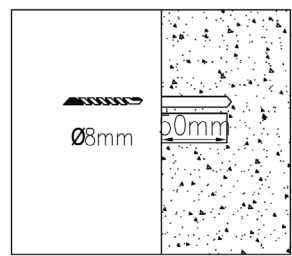
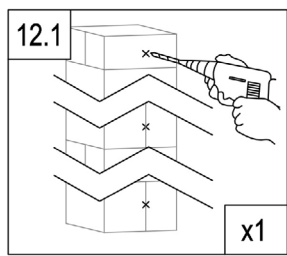
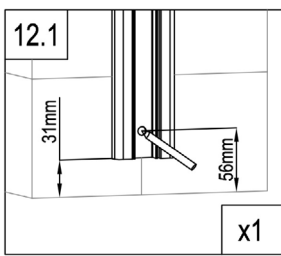
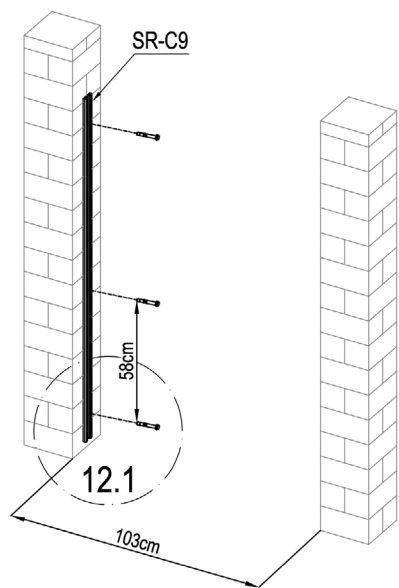
CASANOVO



	SR-C9	1
	SR-Q34	3

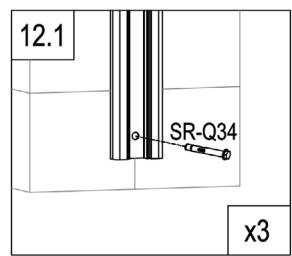

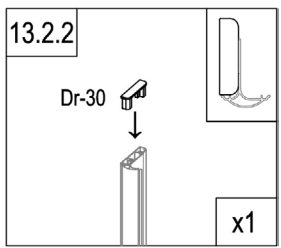
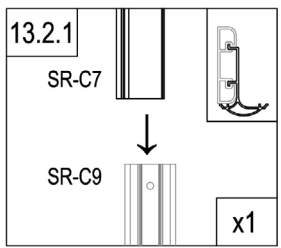
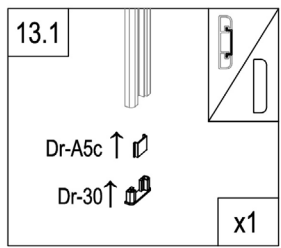
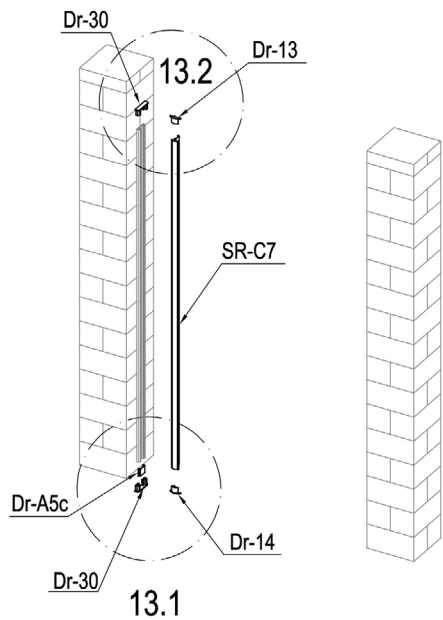

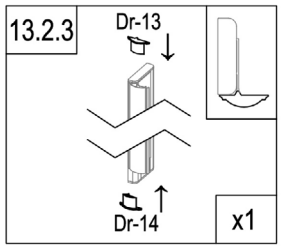

	SR-C7	1
	Dr-13	1
	Dr-14	1
	Dr-30	2
	Dr-A5c	1

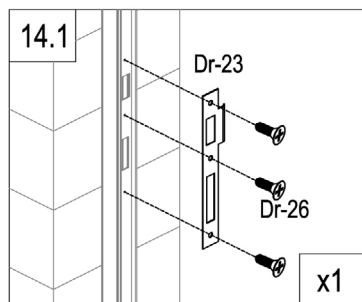
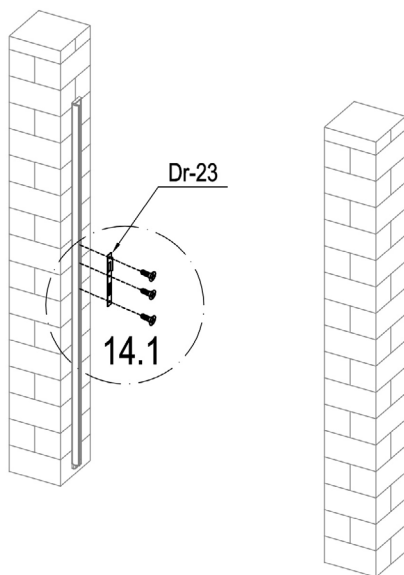



	Dr-23	1
	Dr-26	3

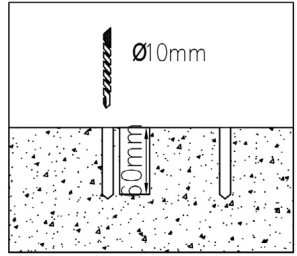
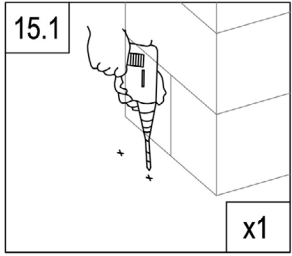
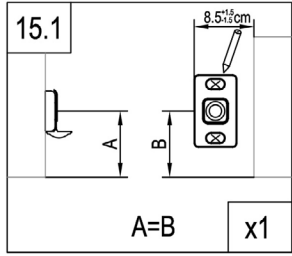
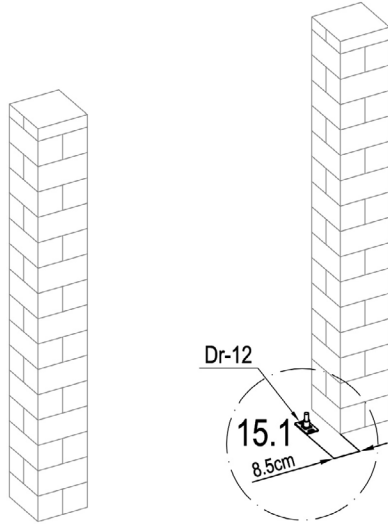

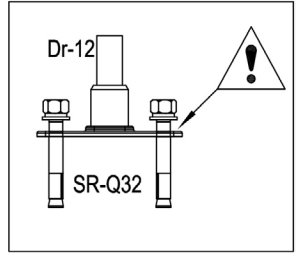
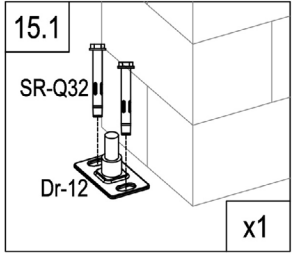

	Dr-12	1
	SR-Q32	2



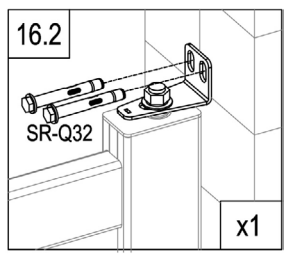
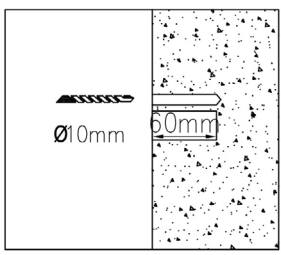
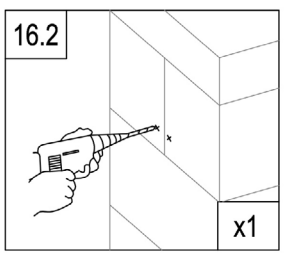
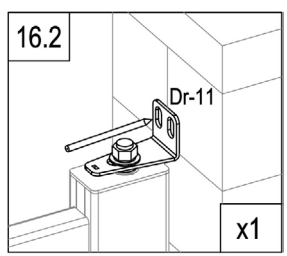
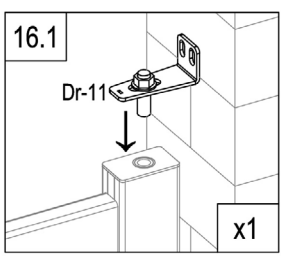
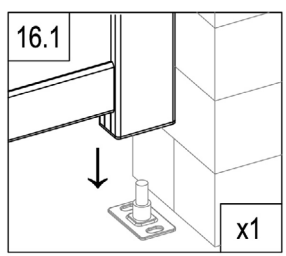
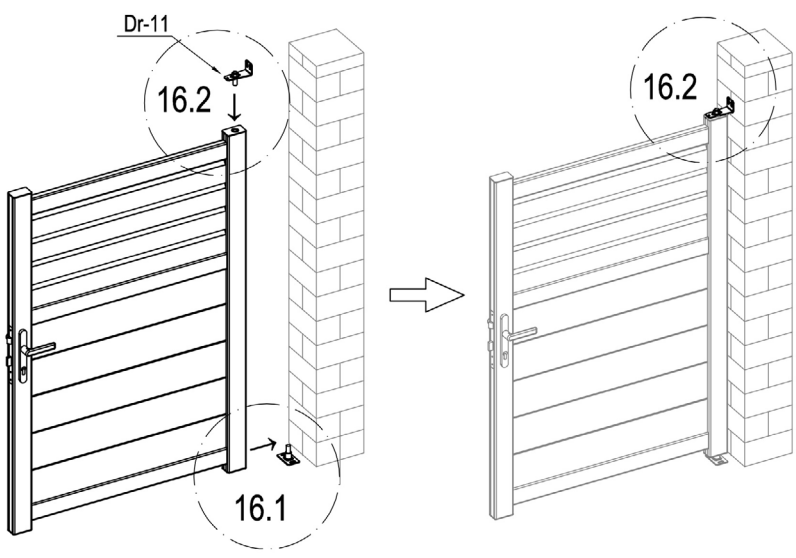

CASANOVO



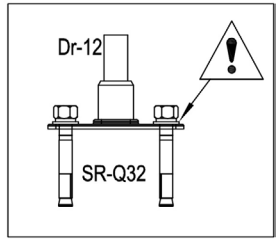
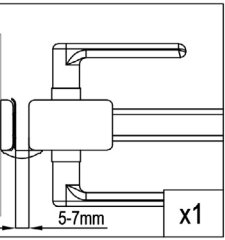
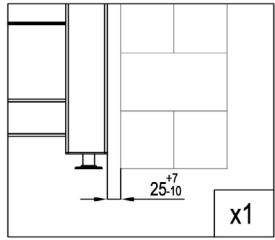
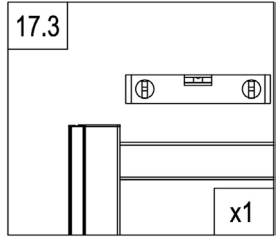
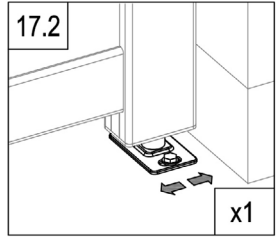
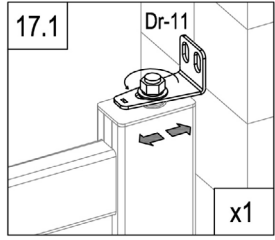
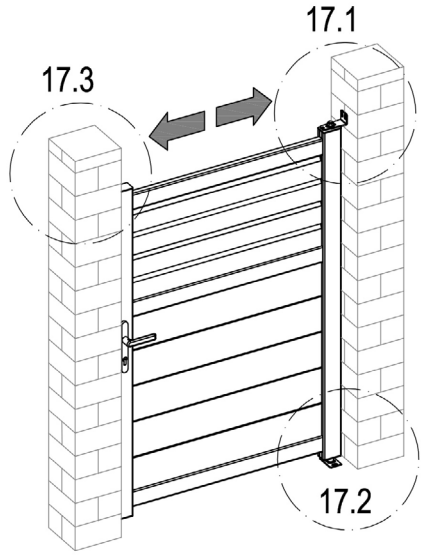

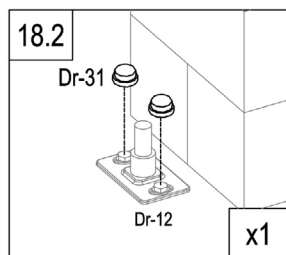
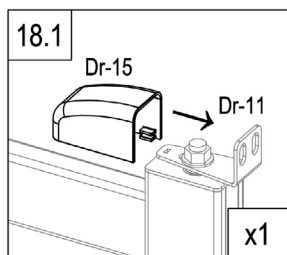
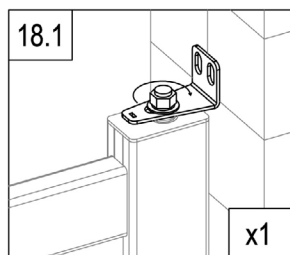
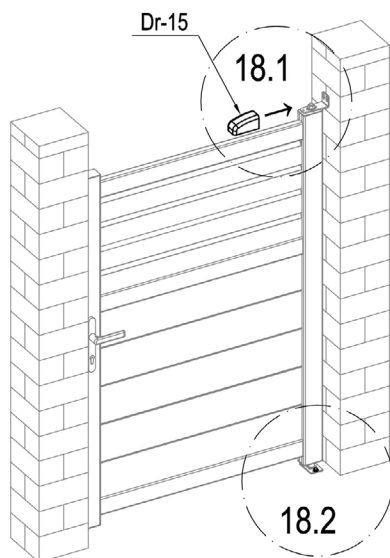
	Dr-11	1
	SR-Q32	2



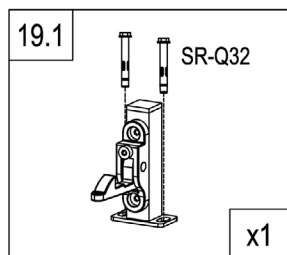
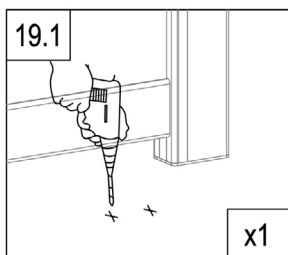
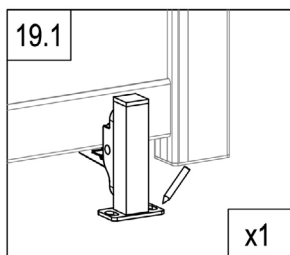
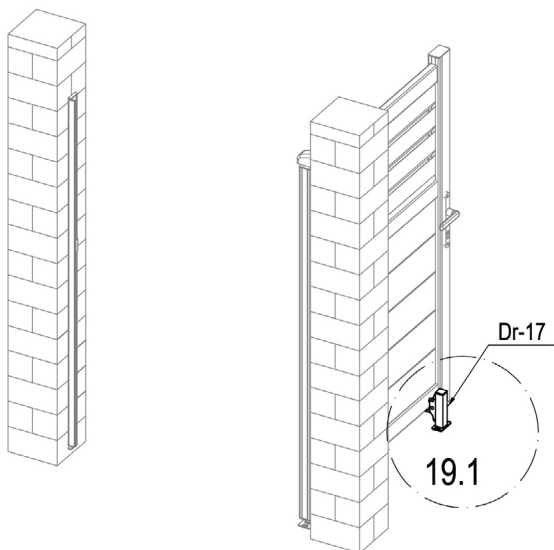

	Dr-15	1
	Dr-31	2



	SR-Q32	2
	Dr-17	1