

CASANOVO

VELETA / SUNNY / ARLBERG 60H160

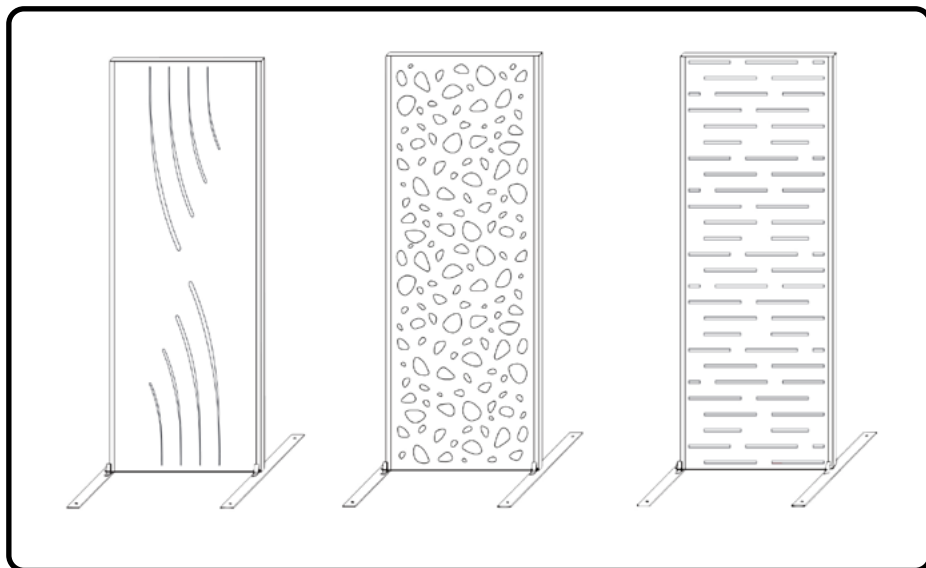

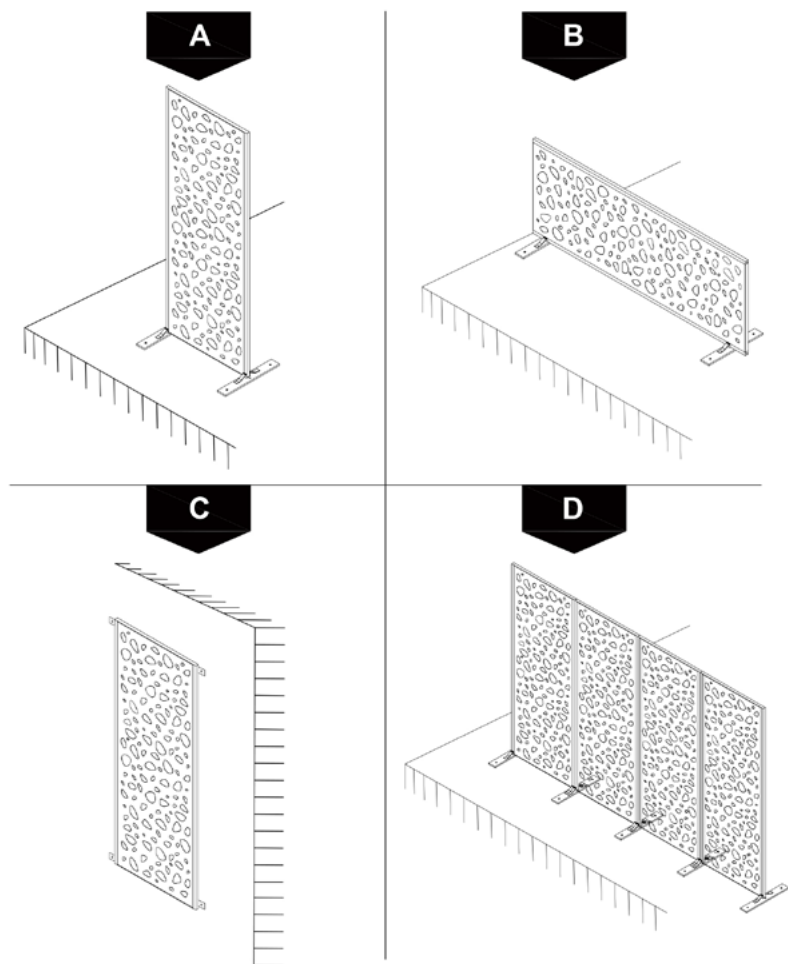





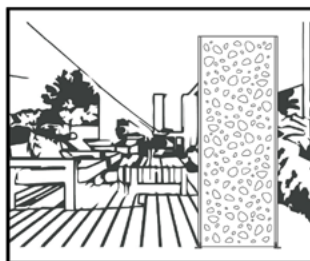
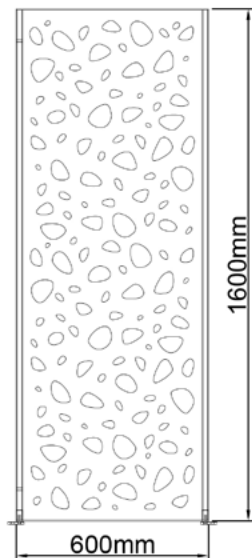

INSTRUCTION MANUAL / NOTICE DE MONTAGE / MONTAGEANLEITUNG / MANUAL DE MONTAJE / MANUAL DE MONTAGEM / MANUALE DI MONTAGGIO /
MONTAGEHANDLEIDING / INSTRUKCJA MONTAŻU / KÄYTTÖOHJEET / BRUKSANVISNING / BRUGSANVISNING / INSTRUCCIUNI DE ASAMBLARE /
NAVODILA ZA SESTAVLJANJE / NÁVOD NA MONTÁŽ / ÖSSZESZERELÉSI ÚTMUTATÓ / NÁVOD K MONTÁŽI / UPUTE ZA INSTALACIJU /
ΟΔΗΓΙΕΣ ΣΥΝΑΡΜΟΛΟΓΗΣΗΣ / SURINKIMO INSTRUKCIJOS / MONTĀŽAS INSTRUKCIJAS



A



a		X2	1/1
b		X2	1/1
c		X4	1/1
d		X8	1/1
e		X2	1/1
f		X2	1/1
g		X1	1/1
h		X1	1/1
i		X4	1/1

A

01

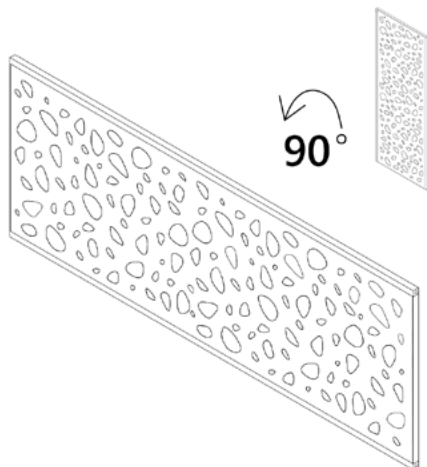

02

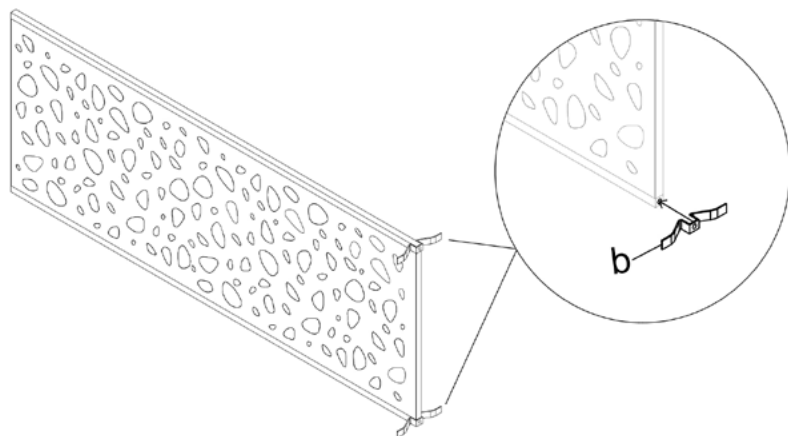

A

03

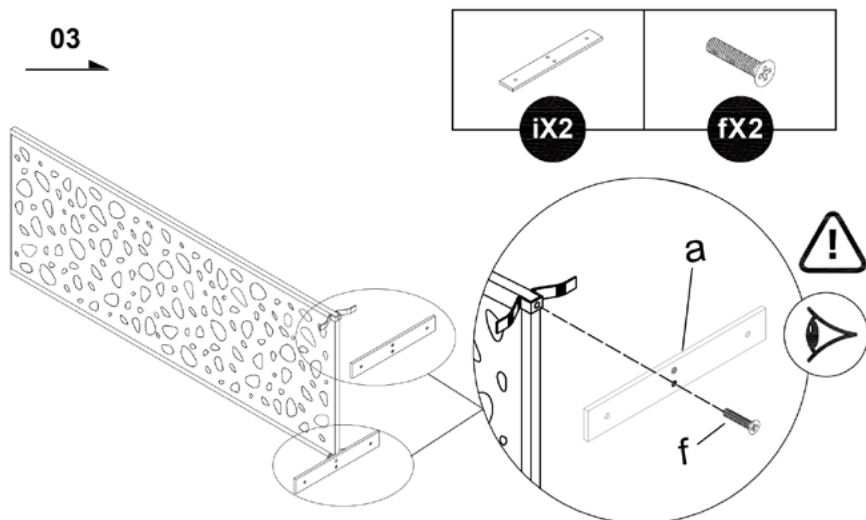

04

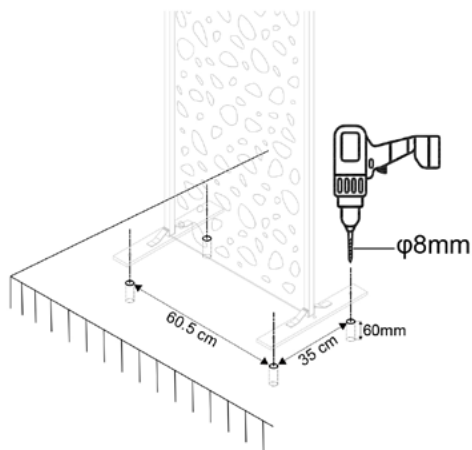





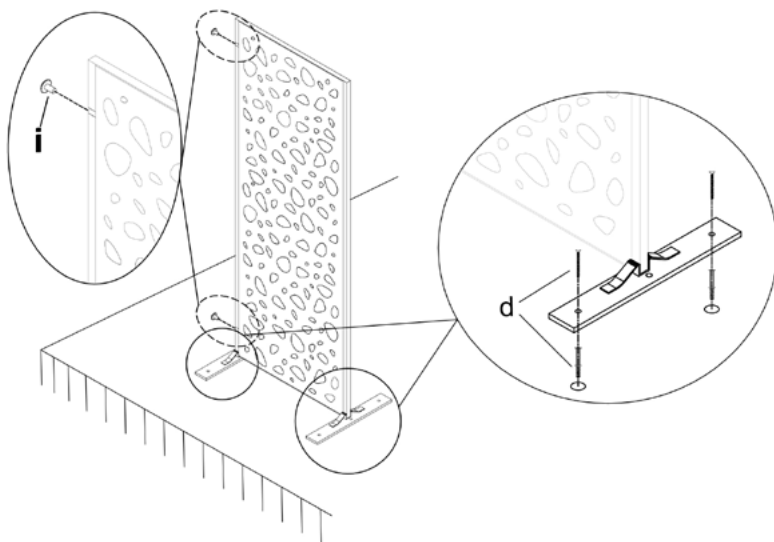
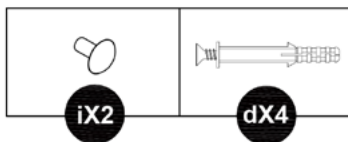



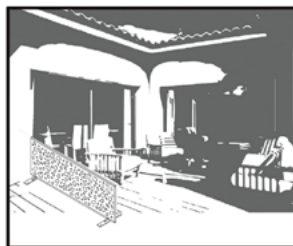
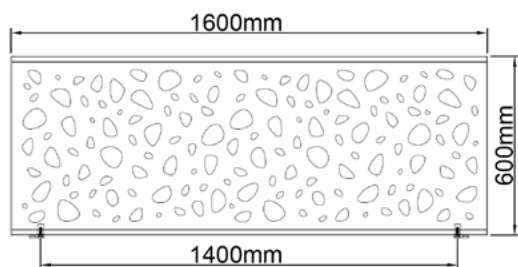

A

05



B



a		X2	1/1
b		X2	1/1
c		X4	1/1
d		X8	1/1
e		X2	1/1
f		X2	1/1
g		X1	1/1
h		X1	1/1
i		X4	1/1

B

01

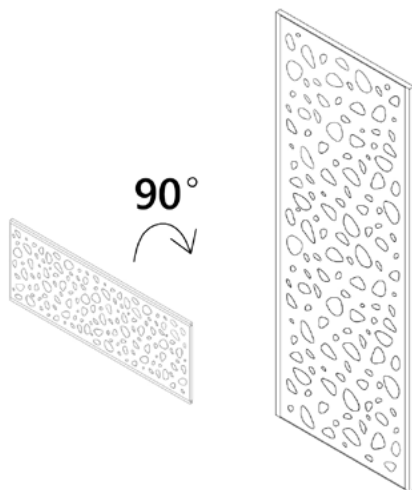

02

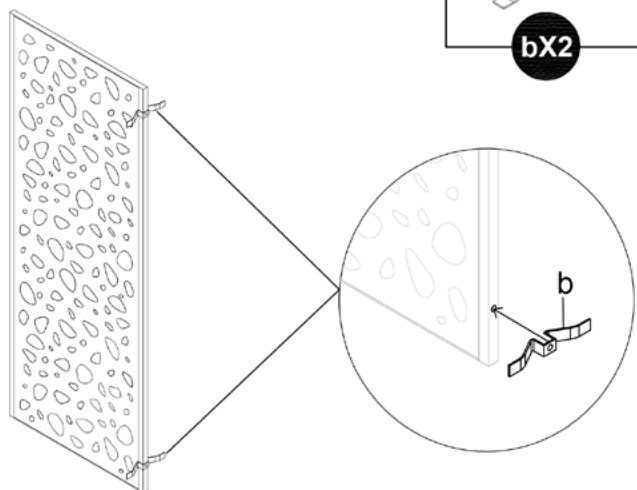

B

03

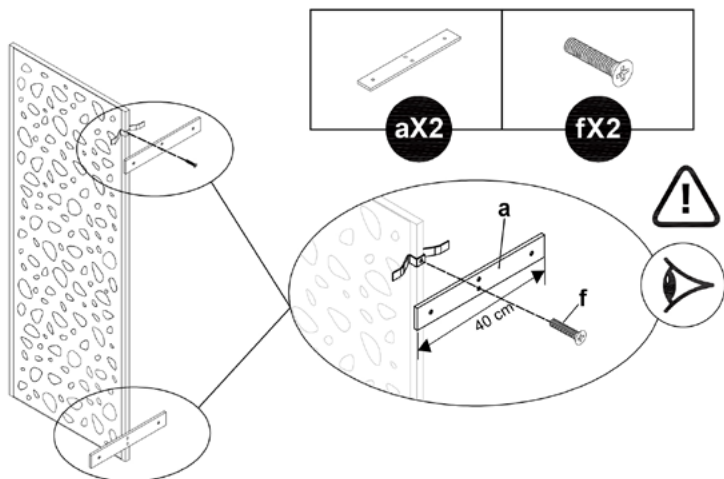

04

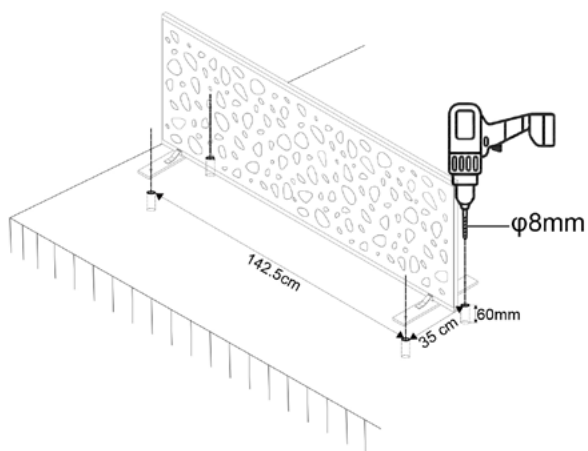

B

05-1

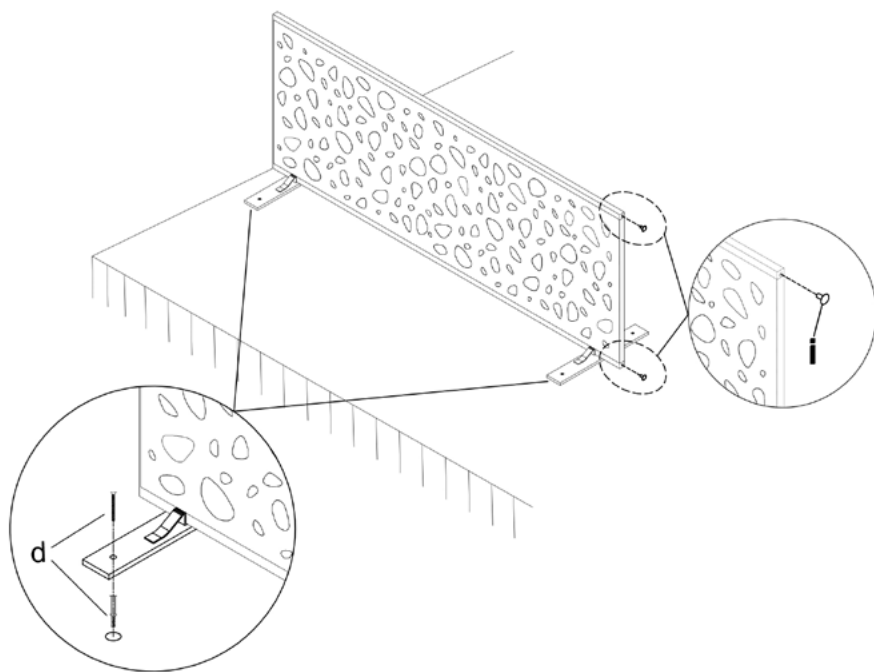
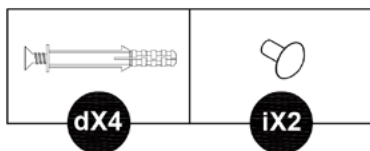





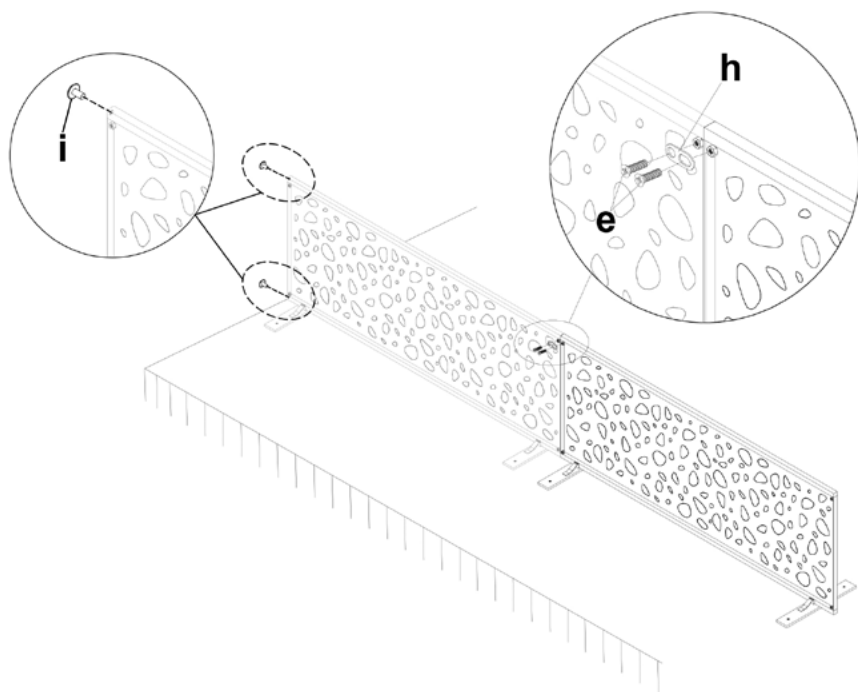
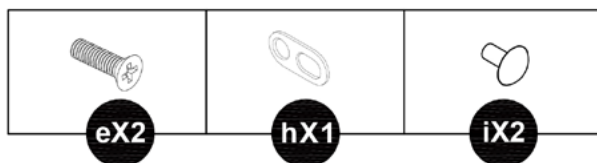



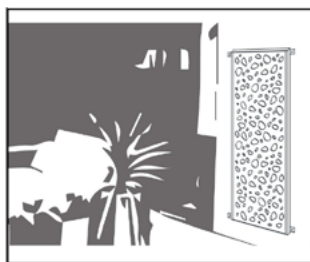

B

05-2



C



a		X2	1/1
b		X2	1/1
c		X4	1/1
d		X8	1/1
e		X2	1/1
f		X2	1/1
g		X1	1/1
h		X1	1/1
i		X4	1/1

C

01

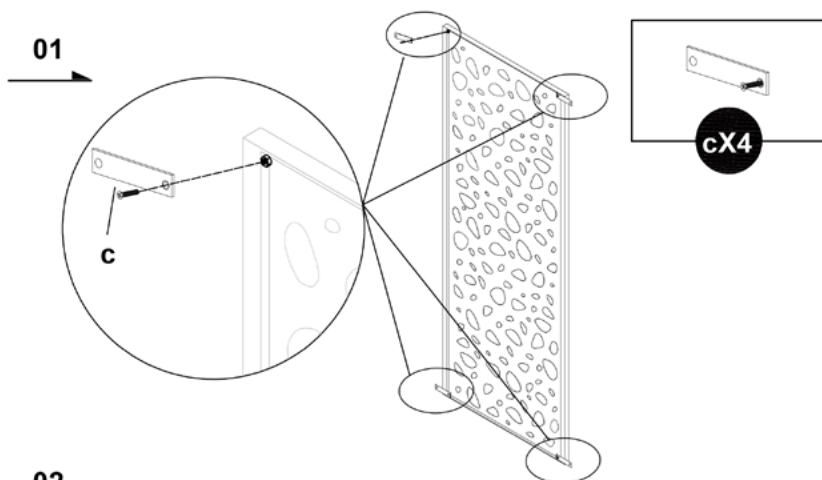

02

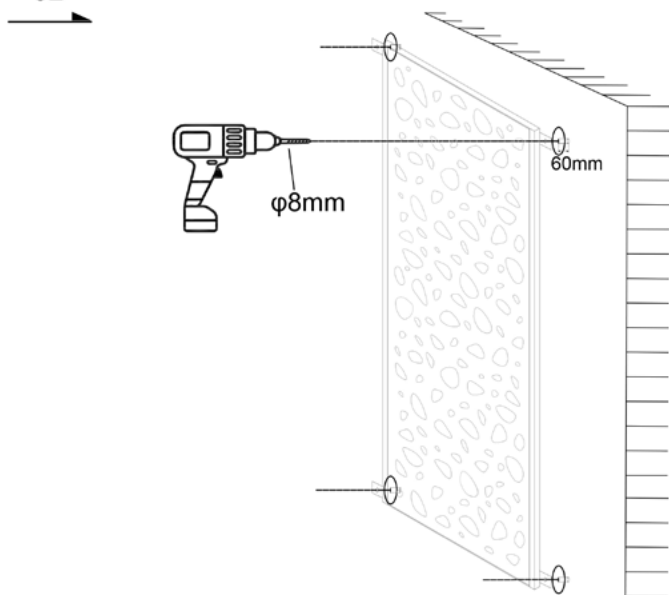

C

03



dX4

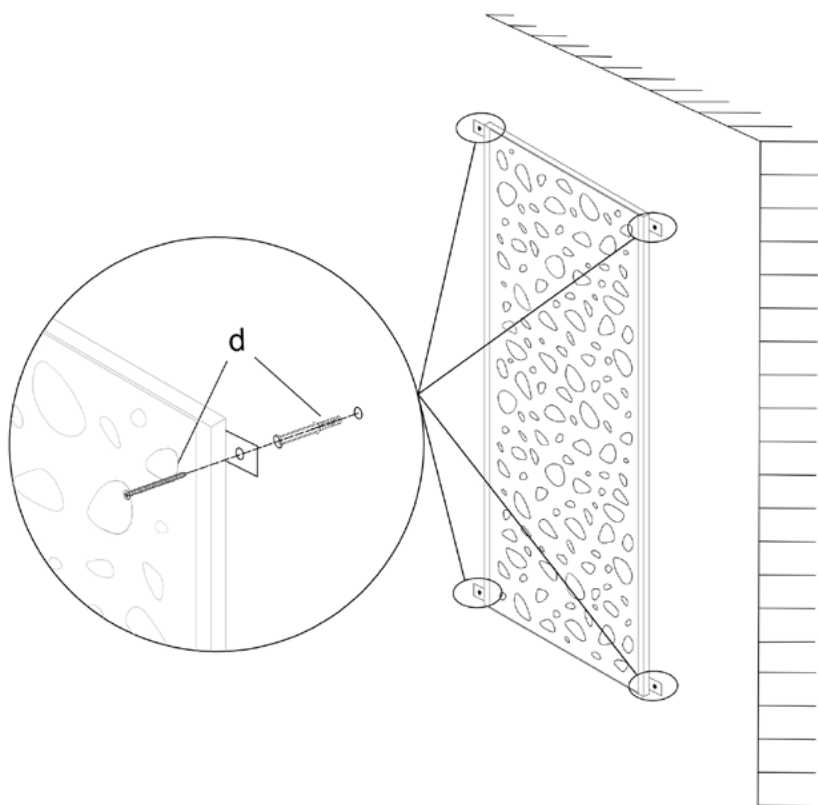

C



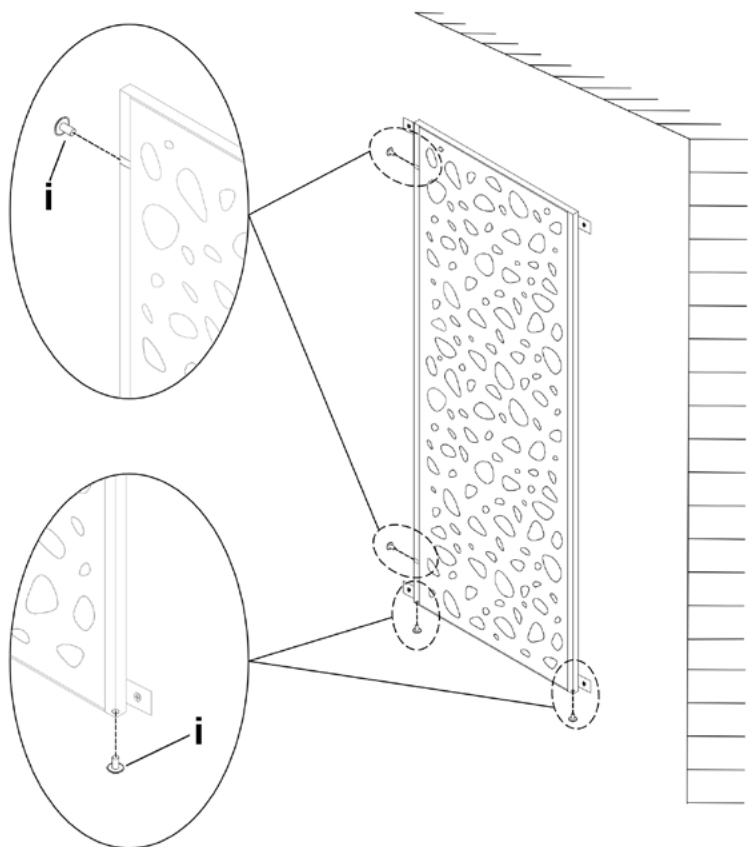
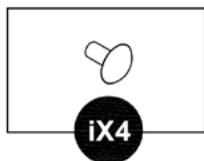



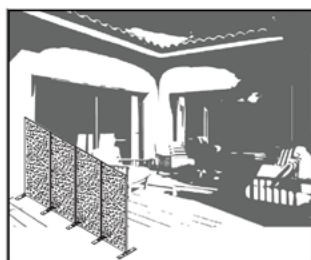
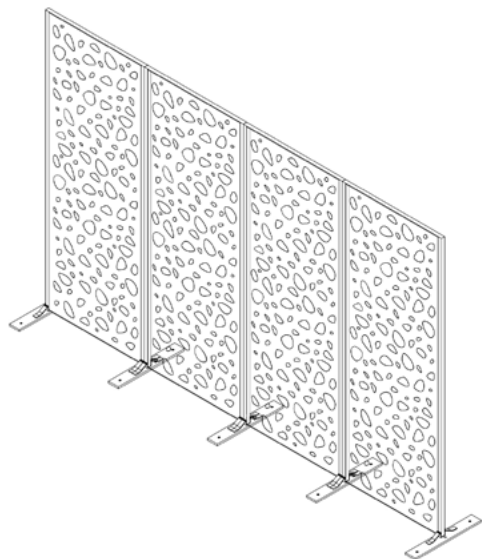

04



CASANOVO

D



a		X2	1/1
b		X2	1/1
c		X4	1/1
d		X8	1/1
e		X2	1/1
f		X2	1/1
g		X1	1/1
h		X1	1/1
i		X4	1/1

D

01

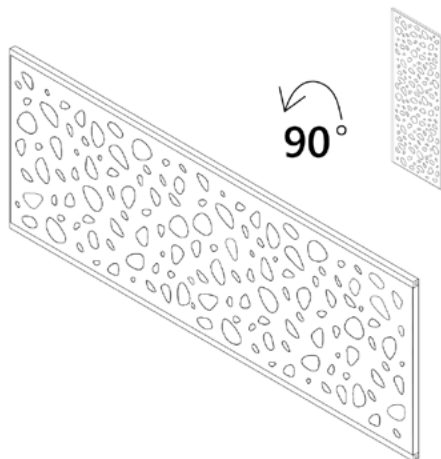

90°

02

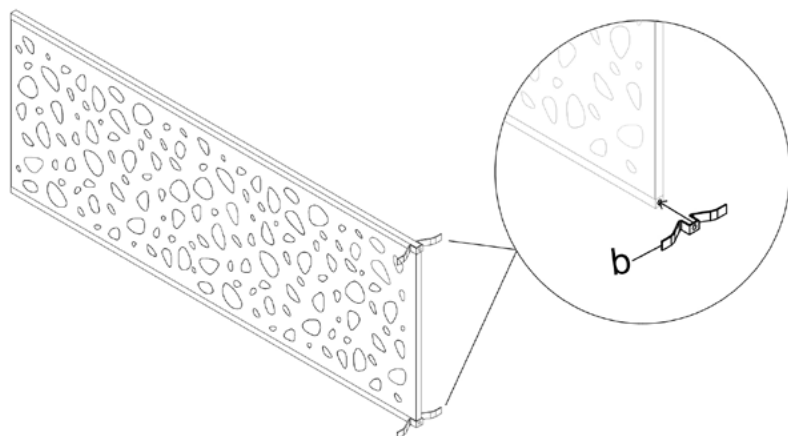

bX2

D

03

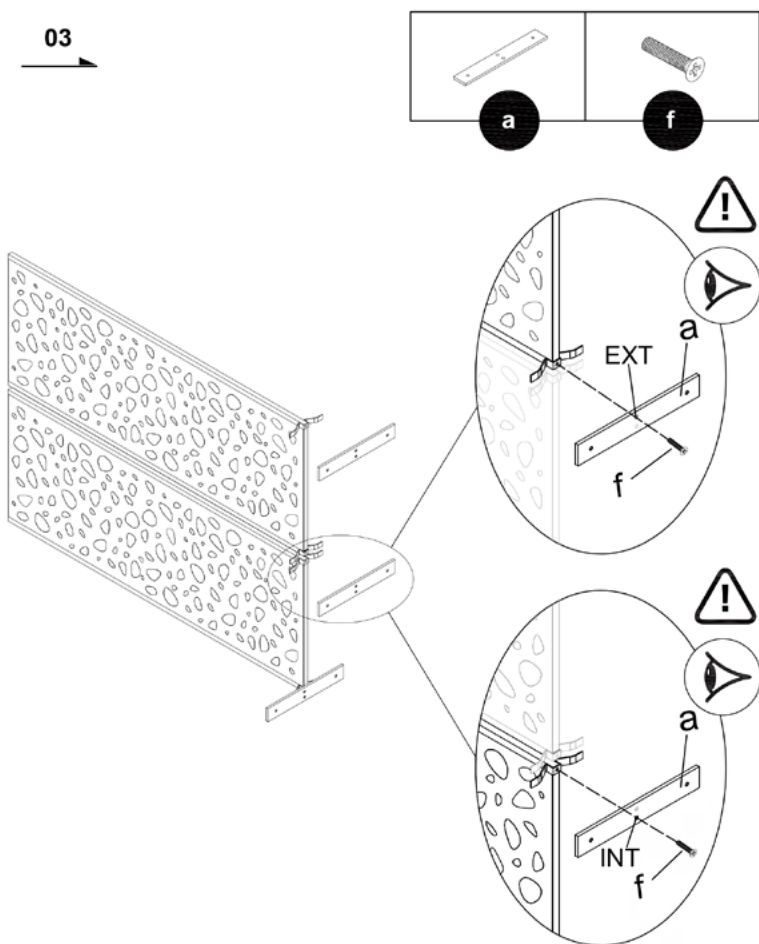

D

04

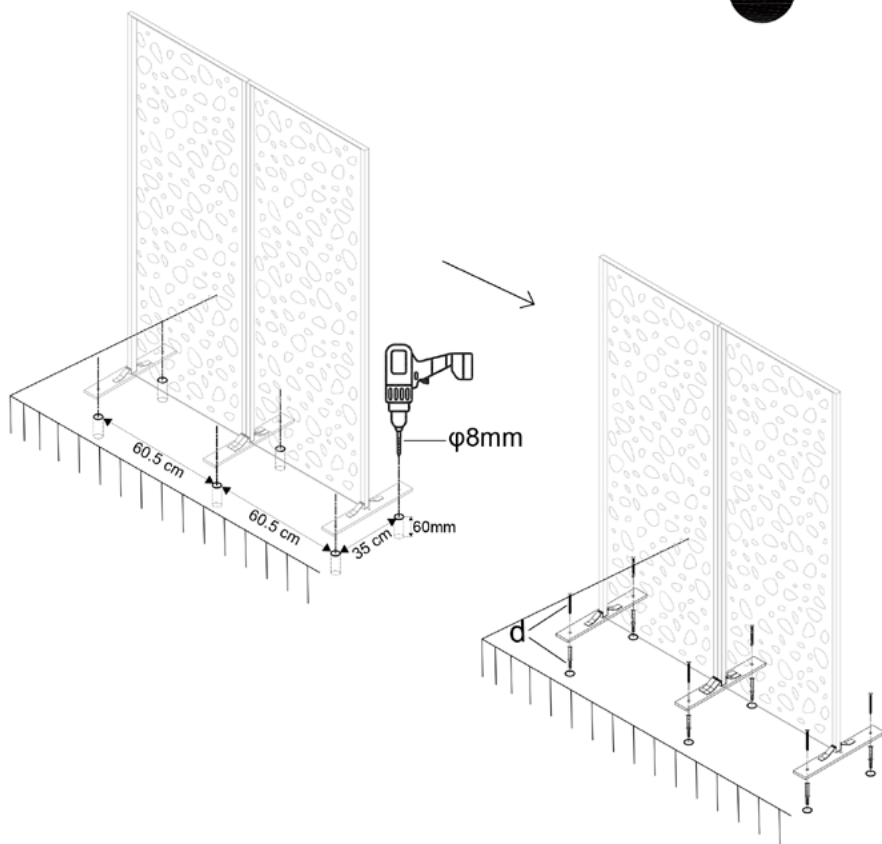
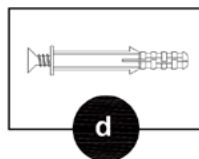

D

05

