

CASANOVO

VEYMONT 100P140

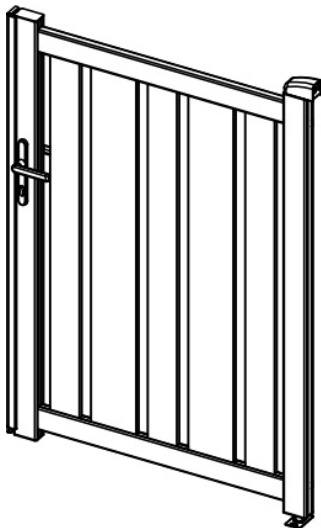

STI-000187 [x1]



3-5H



X 2





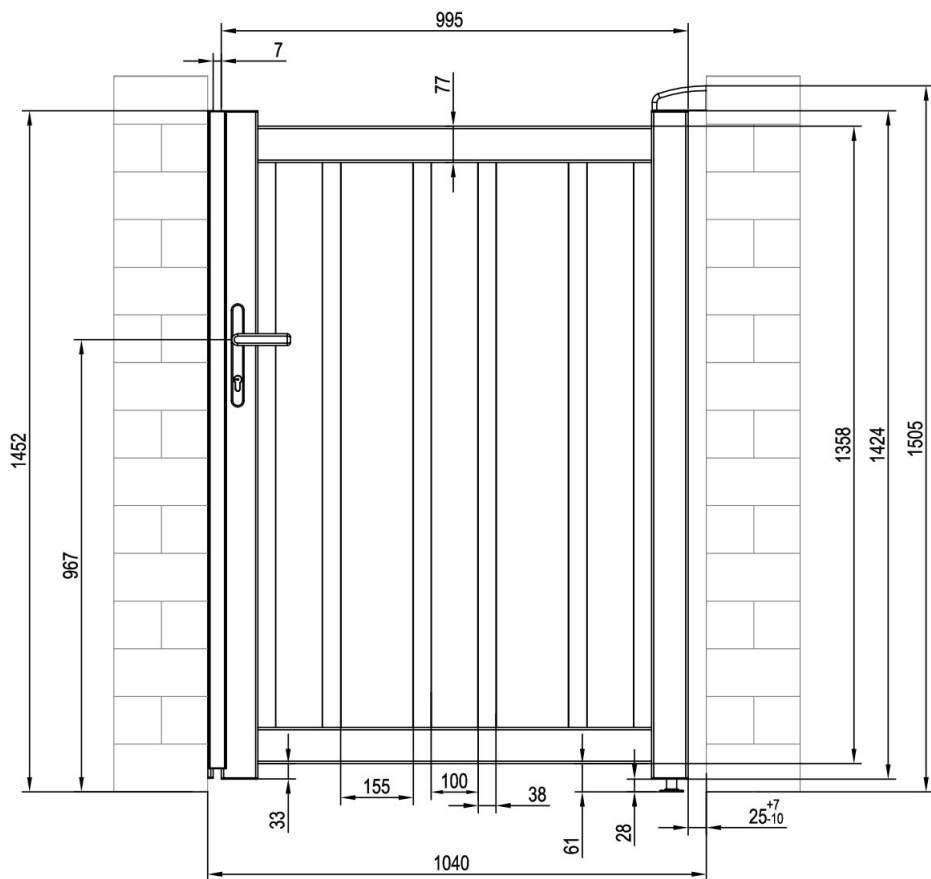

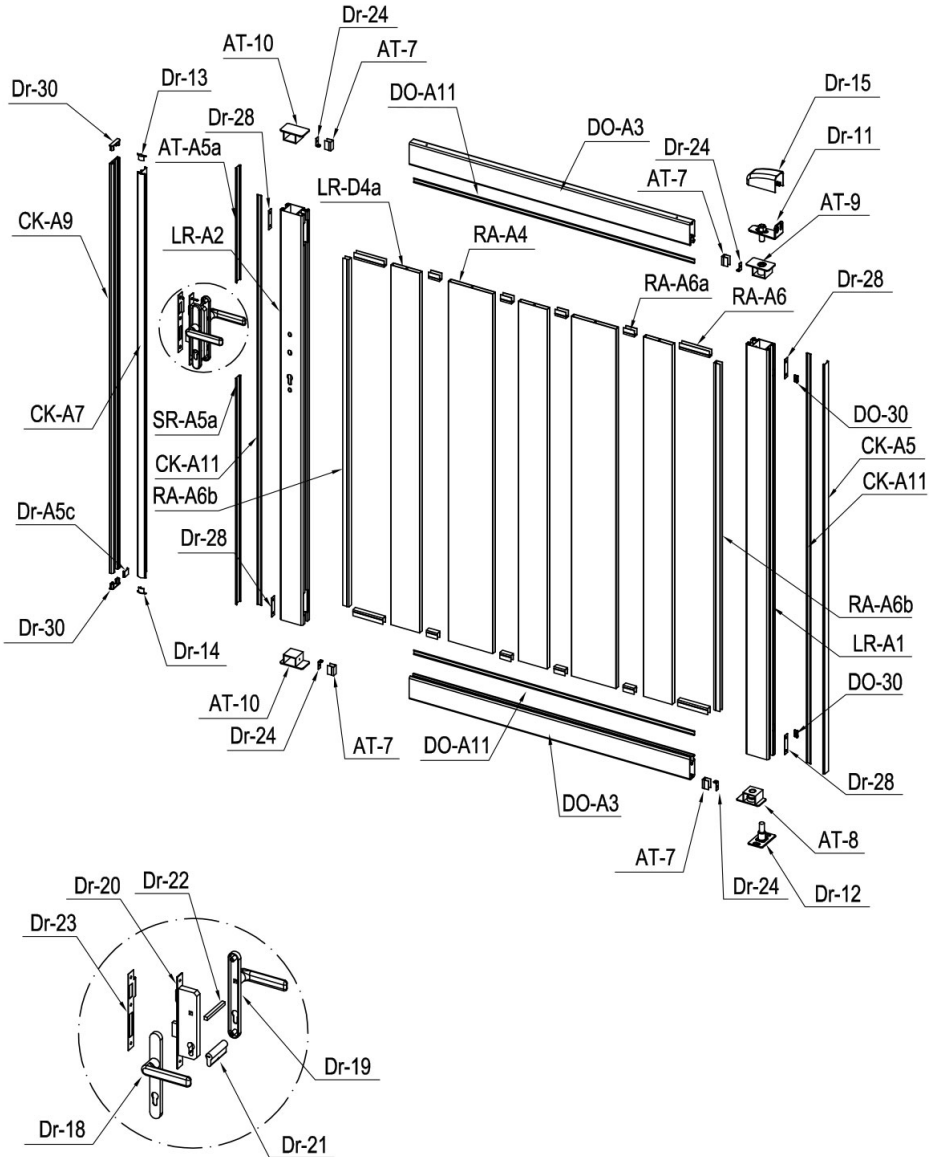

































INSTRUCTION MANUAL / NOTICE DE MONTAGE / MONTAGEANLEITUNG / MANUAL DE MONTAJE / MANUAL DE MONTAGEM / MANUALE DI MONTAGGIO /
MONTAGEHANDLEIDING / INSTRUKCJA MONTAŻU / KÄYTTÖOHJEET / BRUKSANVISNING / BRUGSANVISNING / INSTRUCȚIUNI DE ASAMBLARE /
NAVODILA ZA SESTAVLJANJE / NÁVOD NA MONTÁŽ / ÖSSZESZERELÉSI ÚTMUTATÓ / NÁVOD K MONTÁŽI / UPUTE ZA INSTALACIJU /
ΟΔΗΓΙΕΣ ΣΥΝΑΡΜΟΛΟΓΗΣΗΣ / SURINKIMO INSTRUKCIJOS / MONTAŽAS INSTRUKCIJAS







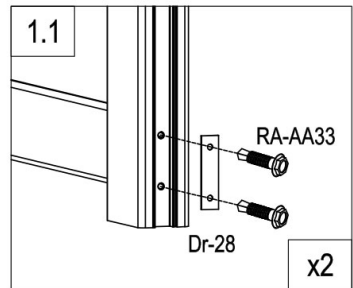
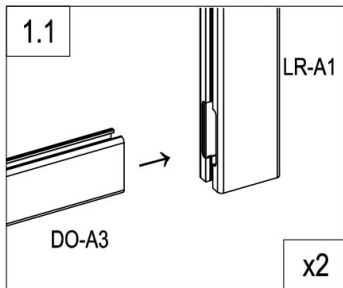
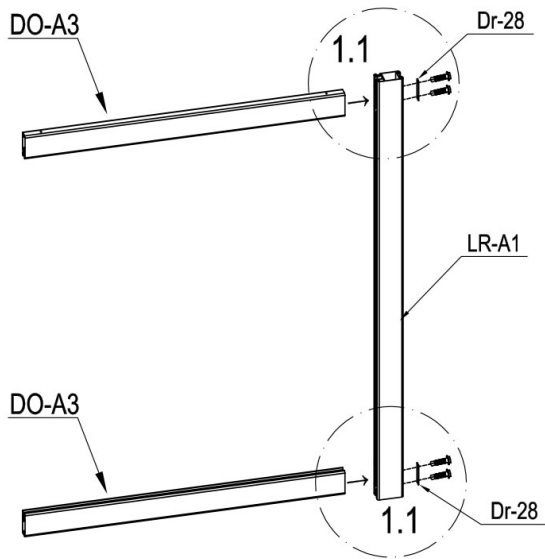

PART LIST

IMAGE	NO.	L.(mm)	QTY	IMAGE	NO.	L.(mm)	QTY
	LR-A1	1418	1		Dr-15		1
	LR-A2	1418	1		Dr-17		1
	DO-A3	972	2		Dr-30		2
	RA-A4	1245	2		Dr-31		2
	LR-D4a	1245	3		DO-30		2
	CK-A5	1418	1		Dr-18		1
	AT-A5a	395.5	1		Dr-19		1
	SR-A5a	782	1		Dr-20		1
	Dr-A5c	19.5	1		Dr-21		1
	CK-A11	1418	2		Dr-22		1
	DO-A11	972	2		Dr-23		1
	AT-7	29.5	4		Dr-25	M5x45	1
	RA-A6	104	4		Dr-25a	M5x60	2
	RA-A6a	38	8		Dr-26	ST4x12	3
	RA-A6b	1202	2		Dr-27	ST4.2x25	2
	CK-A7	1398	1		Dr-24		4
	CK-A9	1418	1		Dr-28		4
	AT-8		1		RA-AA30	ST4x10	4
	AT-9		1		RA-AA31	ST4.2x13	18
	AT-10		2		RA-AA32	M8x60	6
	Dr-11		1		RA-AA33	ST5.5x38	8
	Dr-12		1		RA-AA34	M6x50	3
	Dr-13		1		RA-AA35	ST4.8x38	4
	Dr-14		1				

CASANOVA



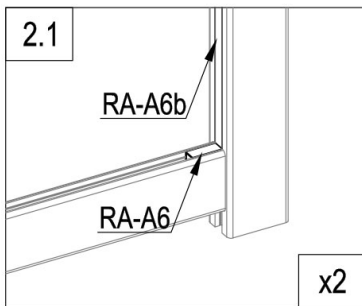
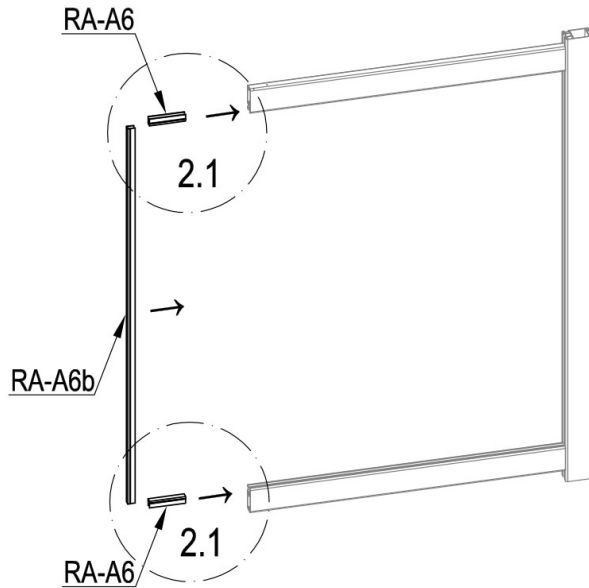

	LR-A1	1
	DO-A3	2
	Dr-28	2
	RA-AA33	4

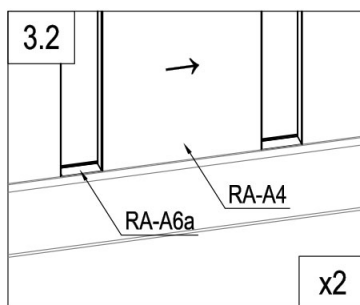
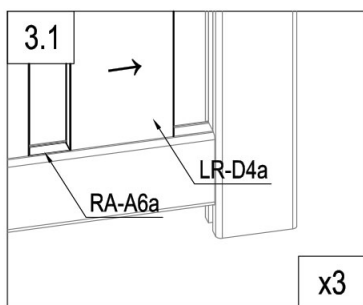
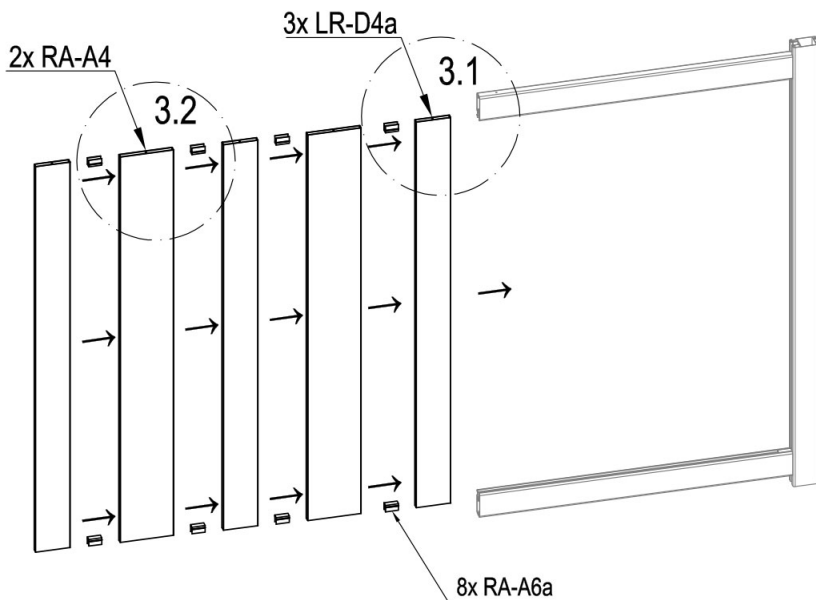

	RA-A6	2
	RA-A6b	1





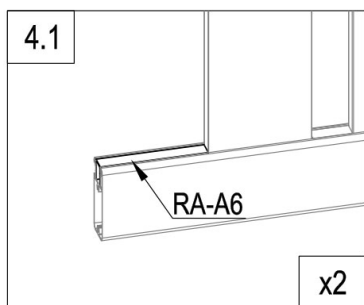
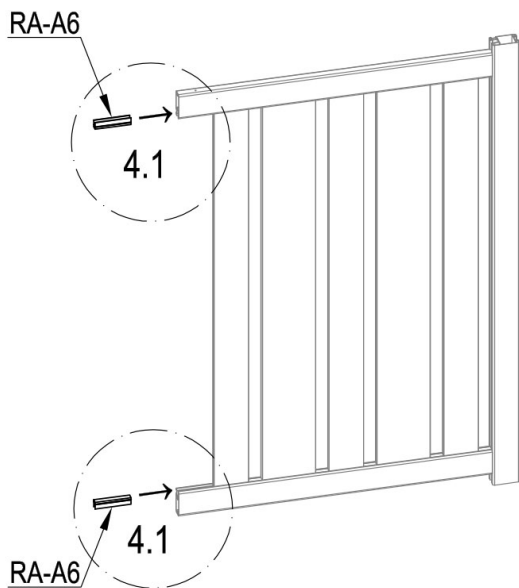

	RA-A4	2
	LR-D4a	3
	RA-A6a	8

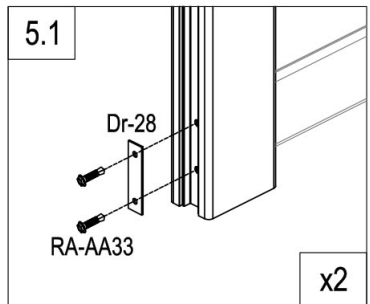
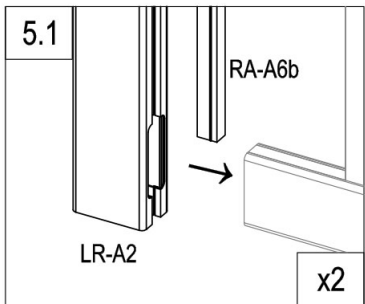
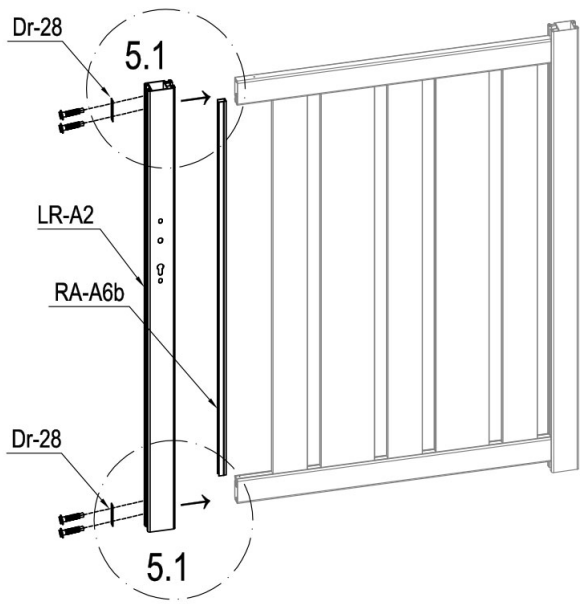



	RA-A6	2
---	-------	---

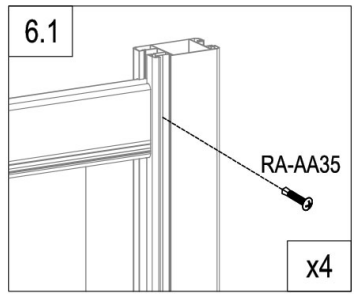
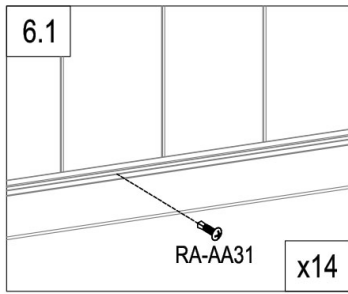
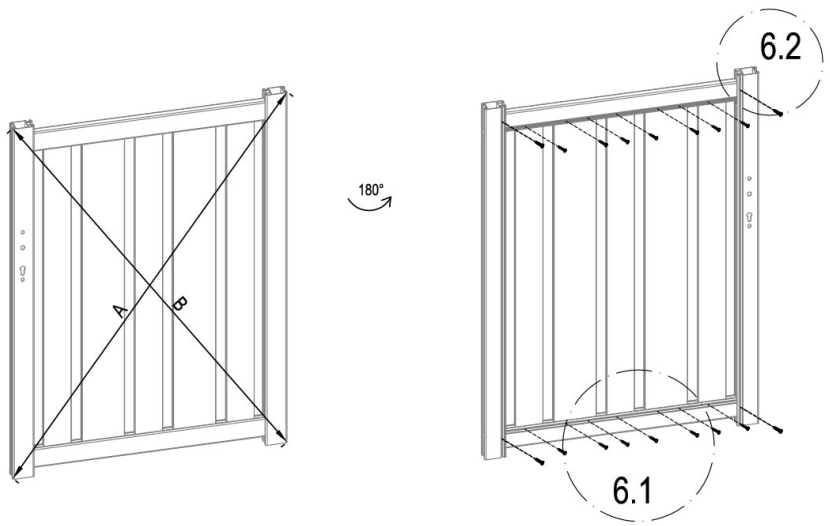

	LR-A2	1
	RA-A6b	1
	Dr-28	2
	RA-AA33	4



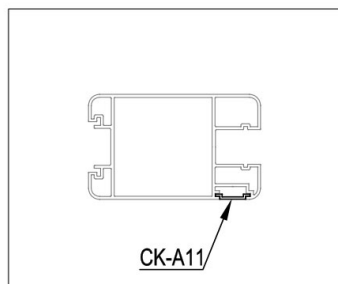
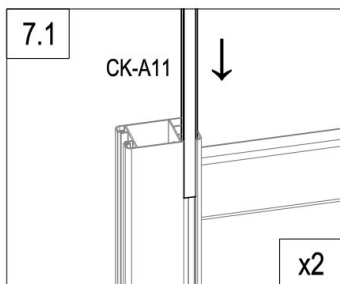
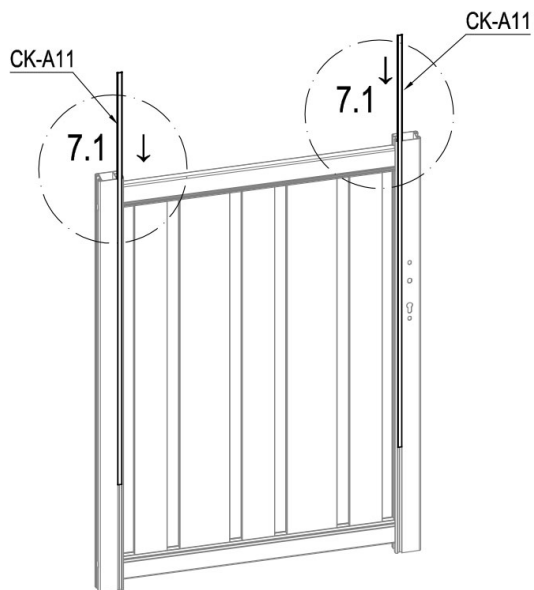

	RA-AA31	14
	RA-AA35	4

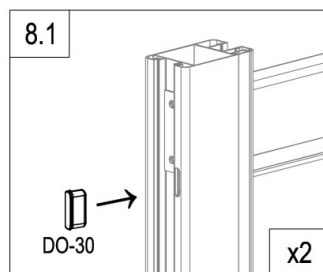
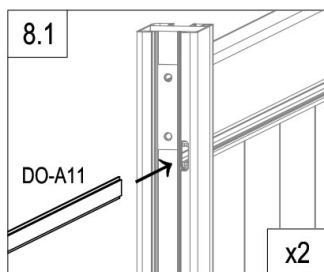
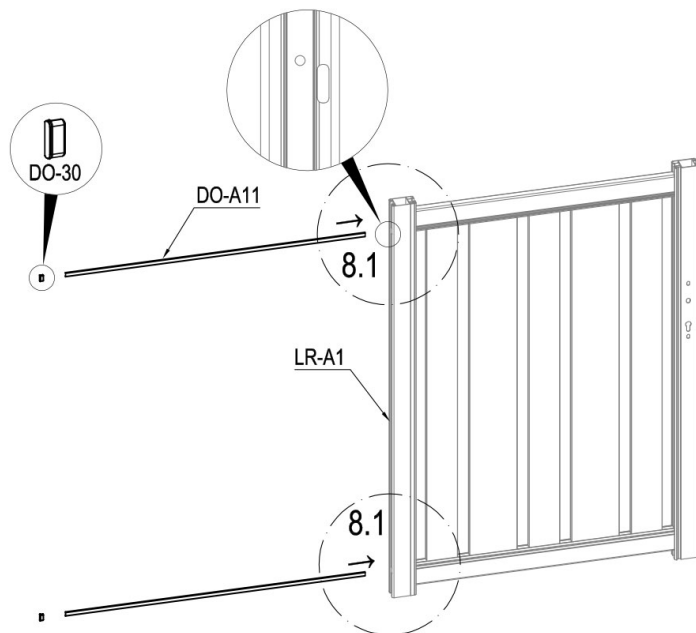

	CK-A11	2
---	--------	---





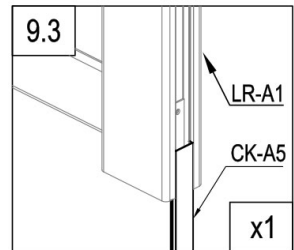
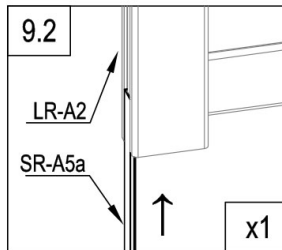
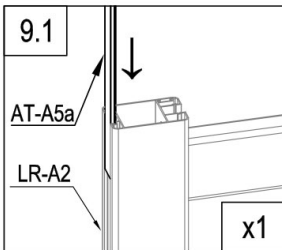
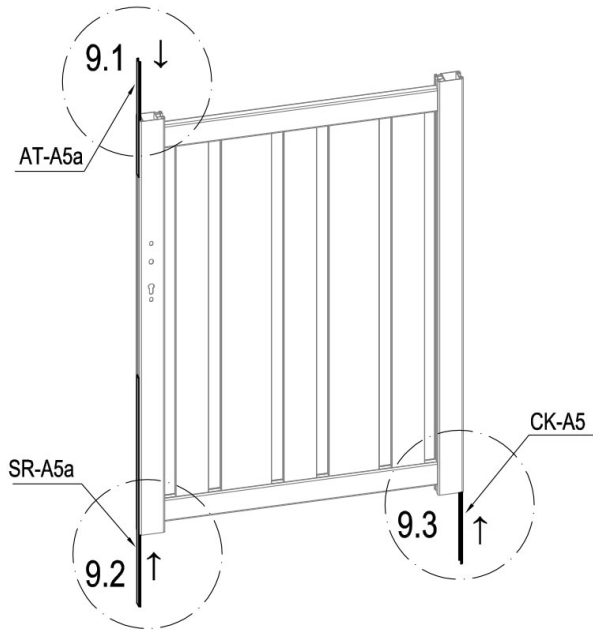

	DO-A11	2
	DO-30	2

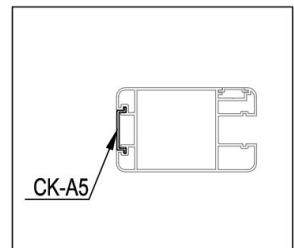

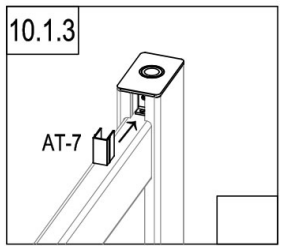
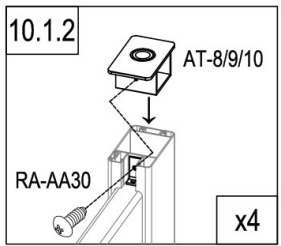
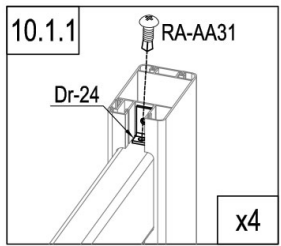
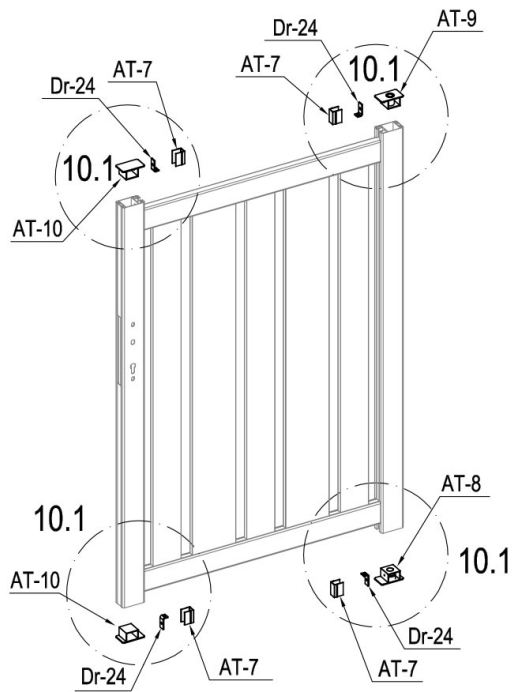

	CK-A5	1
	AT-A5a	1
	SR-A5a	1





	AT-8	1
	AT-9	1
	AT-10	2
	Dr-24	4

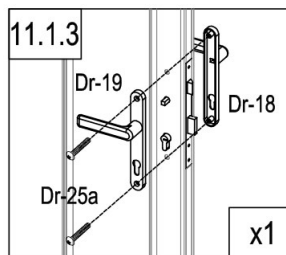
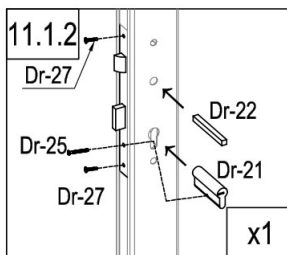
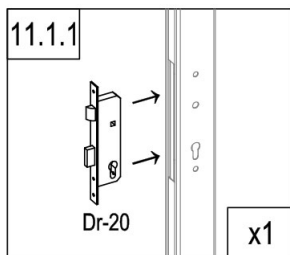
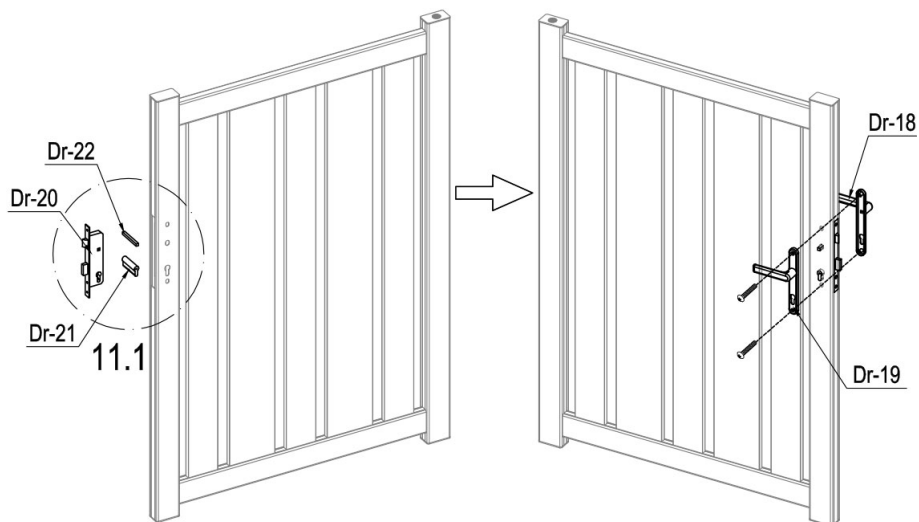

	AT-7	4
	RA-AA30	4
	RA-AA31	4

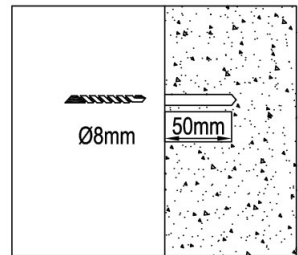
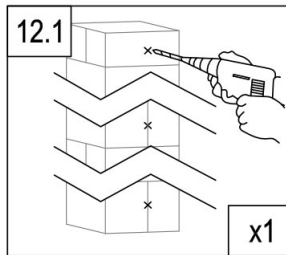
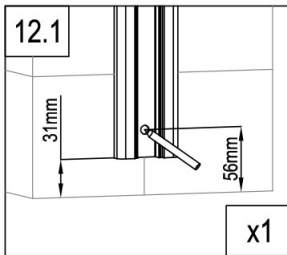
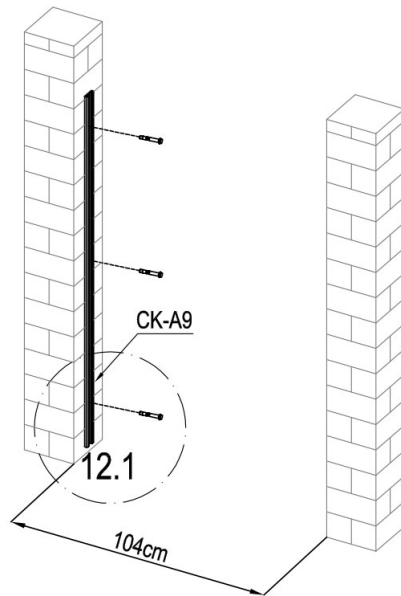

	Dr-20	1
	Dr-21	1
	Dr-22	1
	Dr-25	1

	Dr-18	1
	Dr-19	1
	Dr-25a	2
	Dr-27	2



	CK-A9	1
	RA-AA34	3

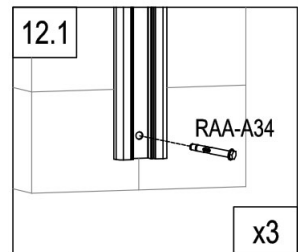

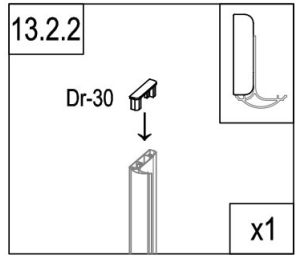
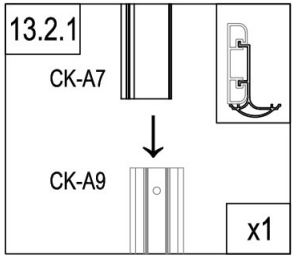
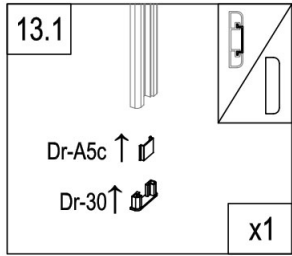
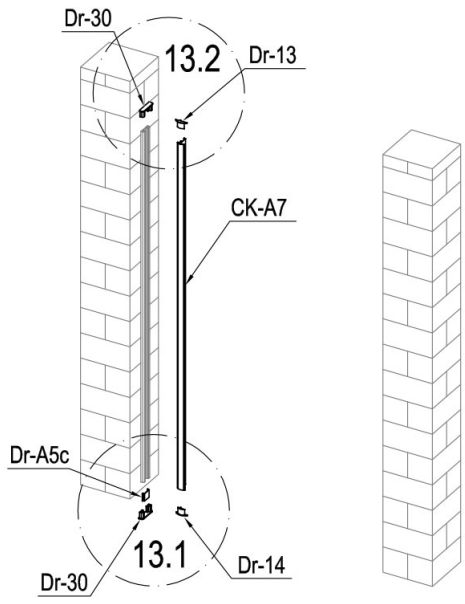



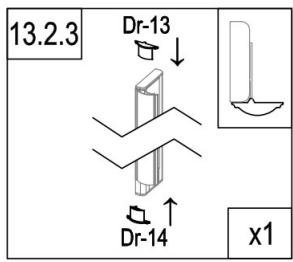

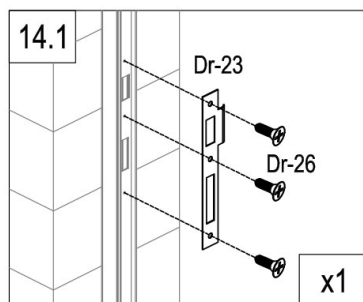
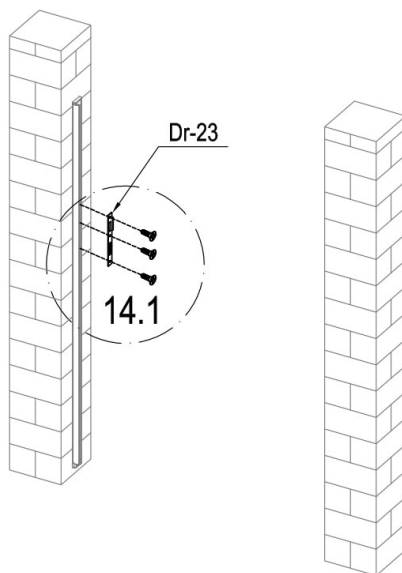
	CK-A7	1
	Dr-13	1
	Dr-14	1
	Dr-30	2
	Dr-A5c	1





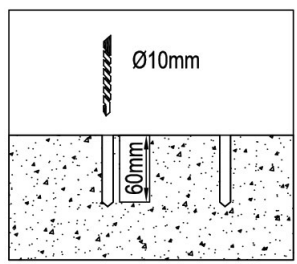
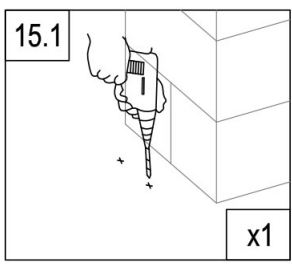
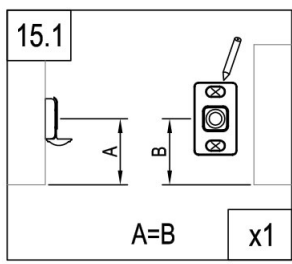
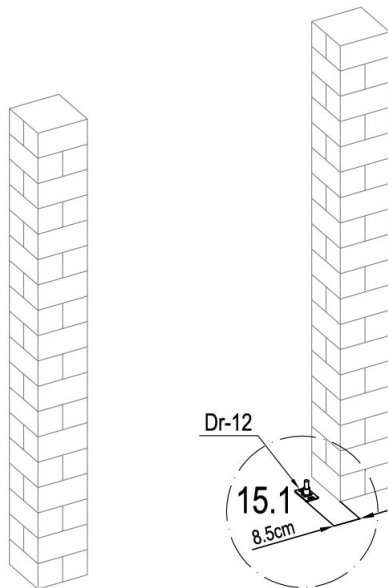

	Dr-23	1
	Dr-26	3

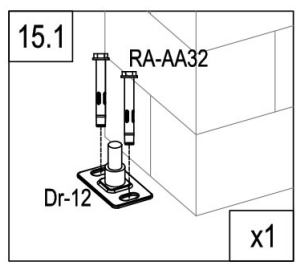

	Dr-12	1
	RA-AA32	2

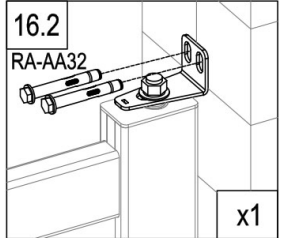
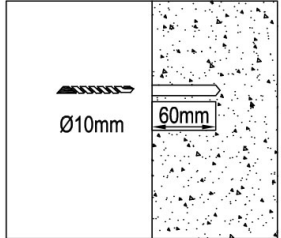
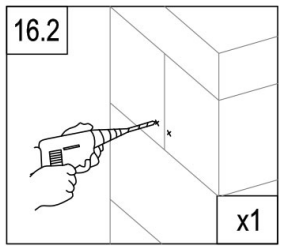
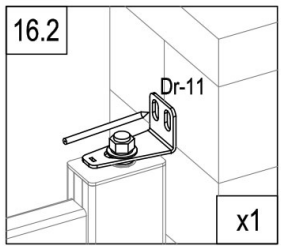
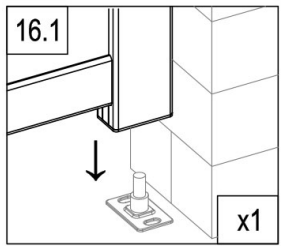
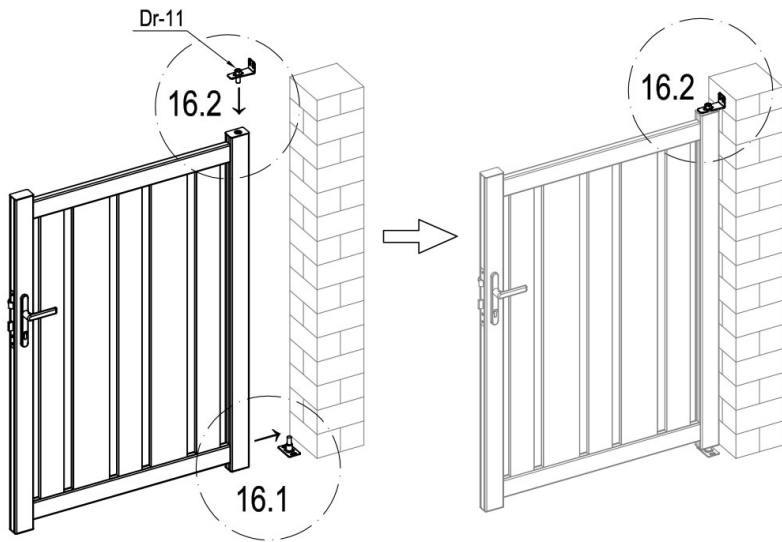





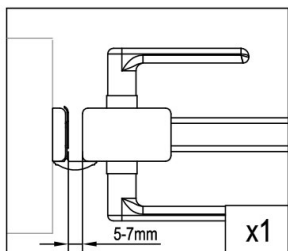
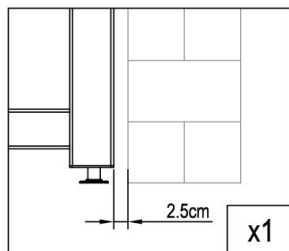
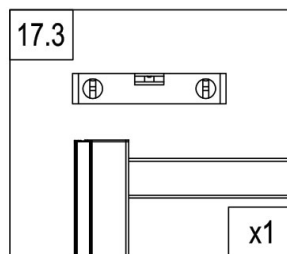
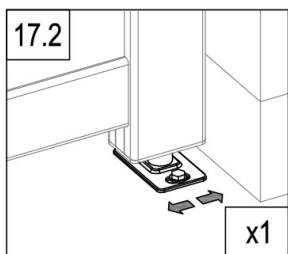
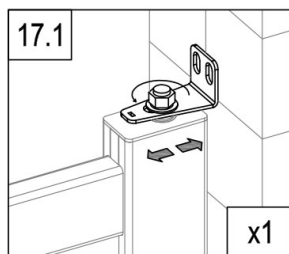
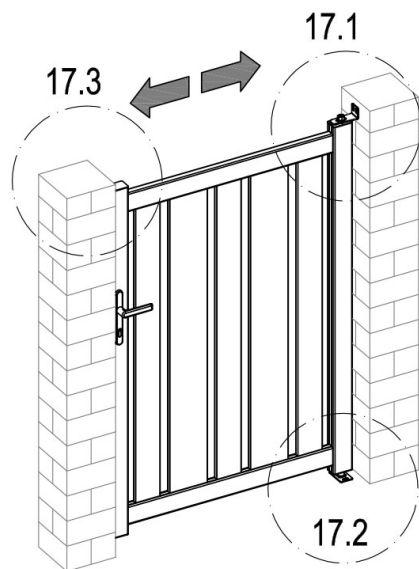

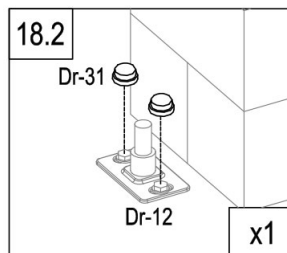
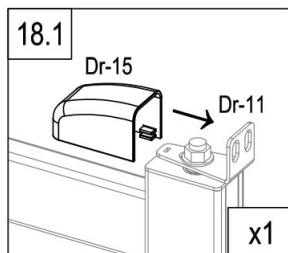
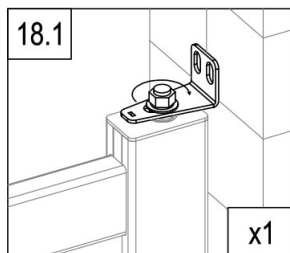
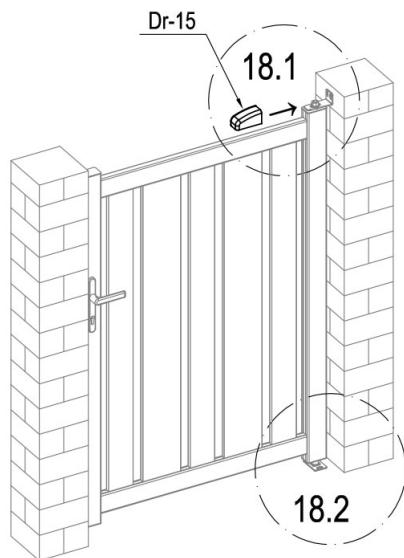
	Dr-11	1
	RA-AA32	2



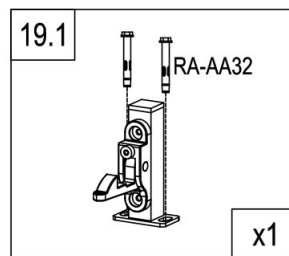
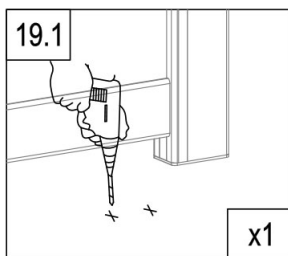
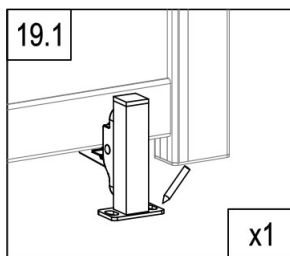
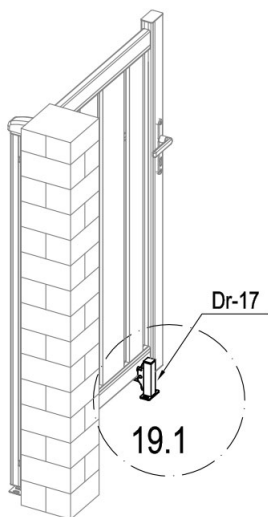

	Dr-15	1
	Dr-31	2



	RA-AA32	2
	Dr-17	1