

CASANOVO

GIONA 100P180

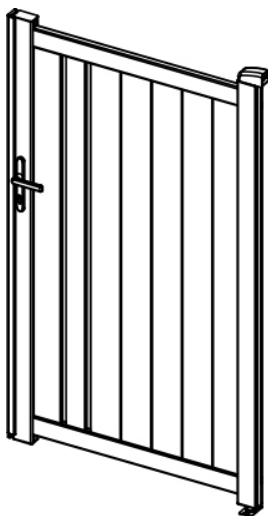

STI-000183 [x1]



3-5H



X 2



INSTRUCTION MANUAL / NOTICE DE MONTAGE / MONTAGEANLEITUNG / MANUAL DE MONTAJE / MANUAL DE MONTAGEM / MANUALE DI MONTAGGIO /
MONTAGEHANDLEIDING / INSTRUKCJA MONTAŻU / KÄYTTÖOHJEET / BRUKSANVISNING / BRUGSANVISNING / INSTRUCȚIUNI DE ASAMBLARE /
NAVODILA ZA SESTAVLJANJE / NÁVOD NA MONTÁŽ / ÖSSZESZERELÉSI ÚTMUTATÓ / NÁVOD K MONTÁŽI / UPUTE ZA INSTALACIJU /
ΟΔΗΓΙΕΣ ΣΥΝΑΡΜΟΛΟΓΗΣΗΣ / SURINKIMO INSTRUKCIJOS / MONTĀŽAS INSTRUKCIJAS

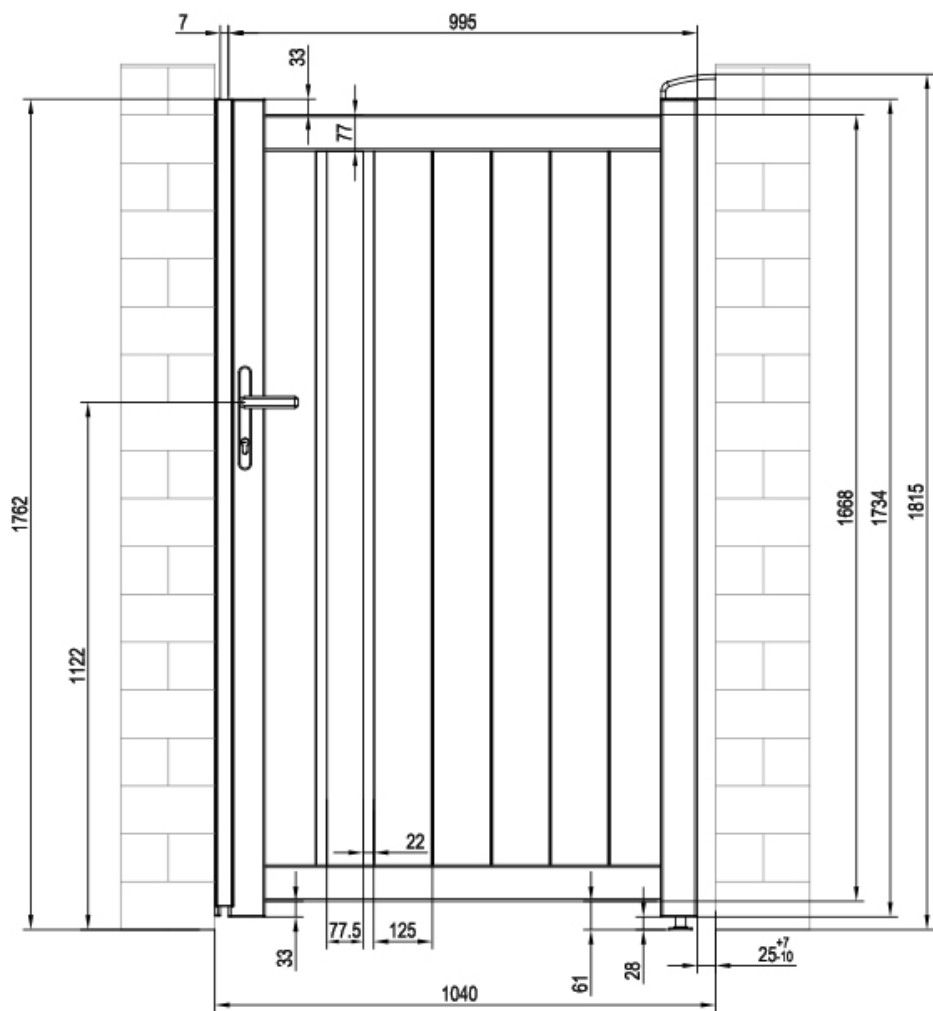

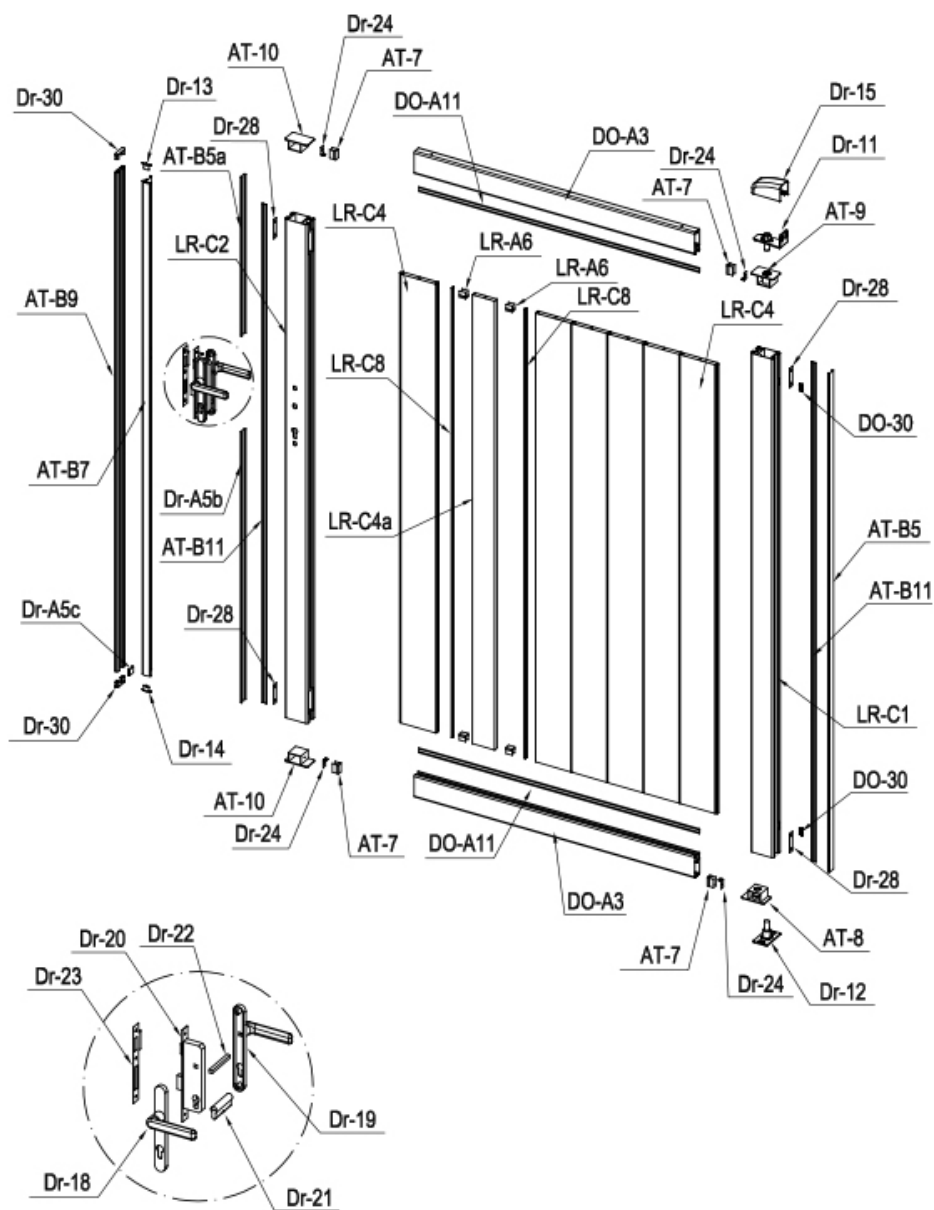







































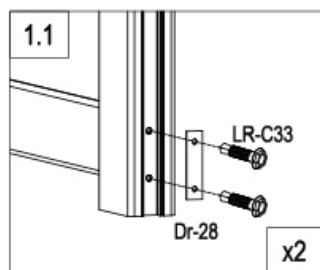
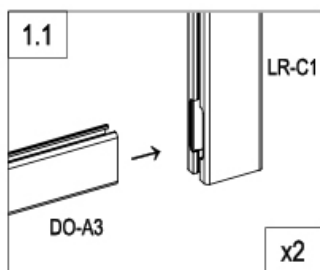
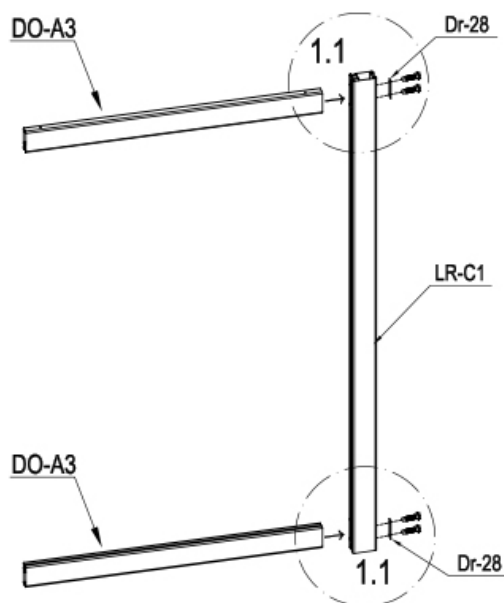



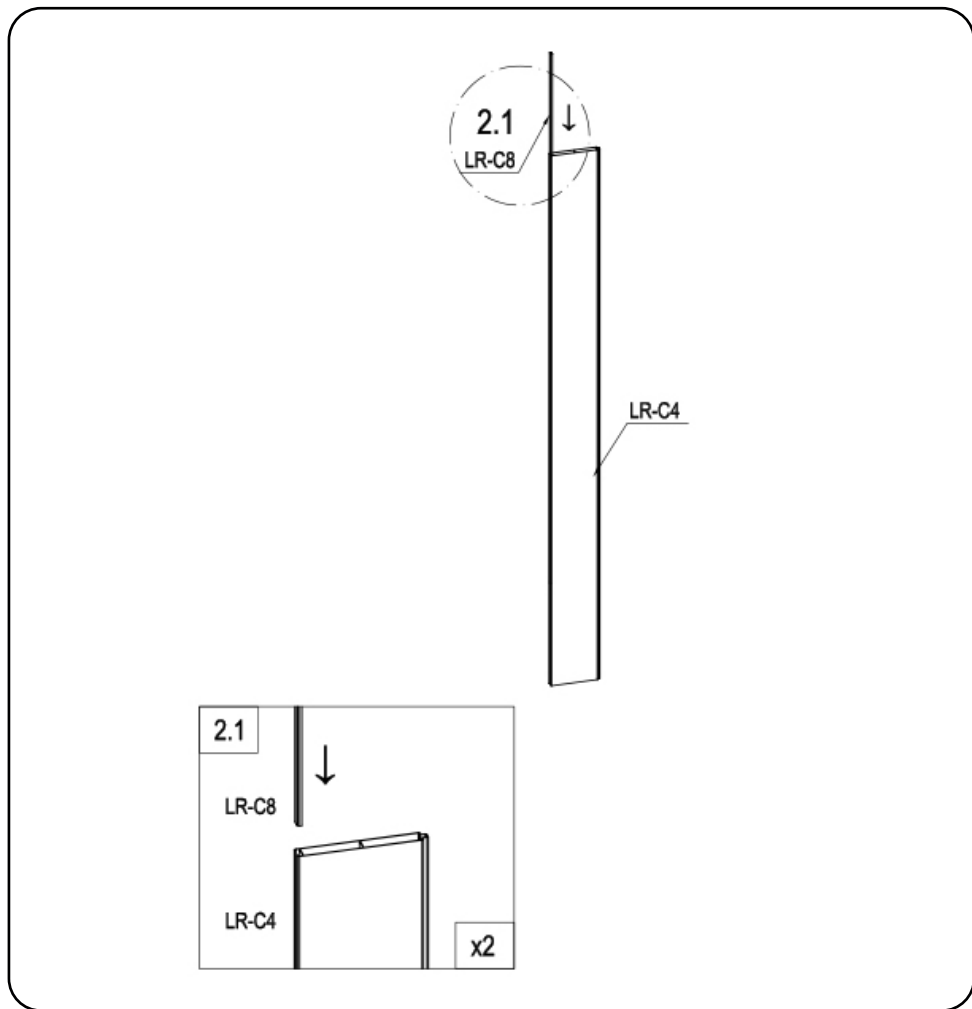



IMAGE	NO.	L.(mm)	QTY	IMAGE	NO.	L.(mm)	QTY
	LR-C1	1728	1		Dr-15		1
	LR-C2	1728	1		Dr-17		1
	DO-A3	972	2		Dr-30		2
	LR-C4	1555	6		Dr-31		2
	LR-C4a	1555	1		Dr-18		1
	AT-B5	1728	1		Dr-19		1
	AT-B5a	550.5	1		Dr-20		1
	Dr-A5b	937	1		Dr-21		1
	Dr-A5c	19.5	1		Dr-22		1
	AT-B11	1728	2		Dr-23		1
	DO-A11	972	2		Dr-24		4
	AT-7	29.5	4		Dr-28		4
	LR-A6	21	4		DO-30		2
	LR-C8	1555	2		Dr-25		1
	AT-B7	1708	1		Dr-25a		2
	AT-B9	1728	1		Dr-26		3
	AT-8		1		Dr-27		2
	AT-9		1		LR-C30		4
	AT-10		2		LR-C31		18
	Dr-11		1		LR-C32		6
	Dr-12		1		LR-C33		8
	Dr-13		1		LR-C34		3
	Dr-14		1		LR-C35		4





	LR-C1	1
	DO-A3	2
	Dr-28	2
	LR-C33	4



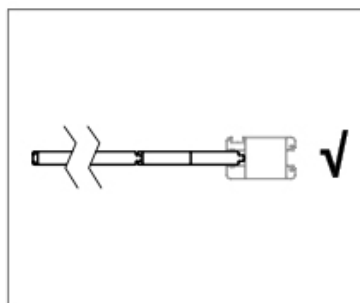
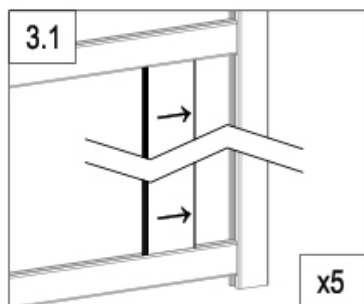
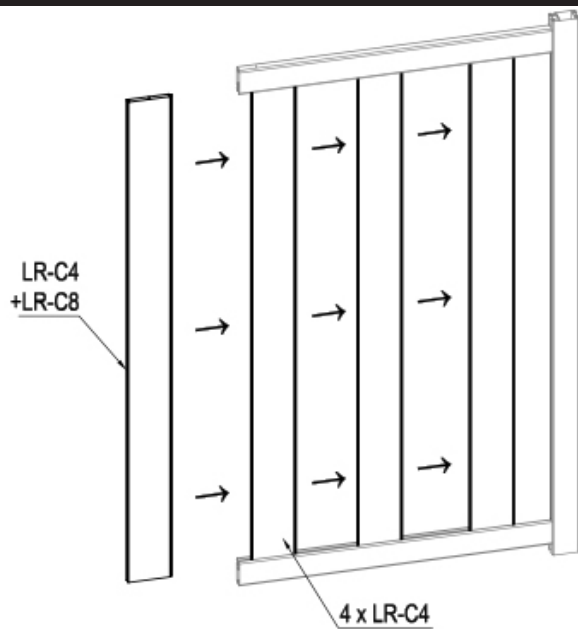

X2

	LR-C8	2
	LR-C4	2



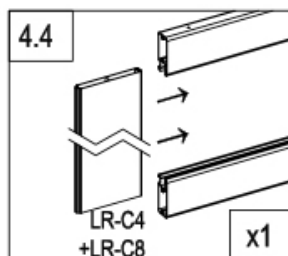
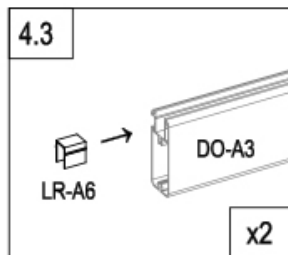
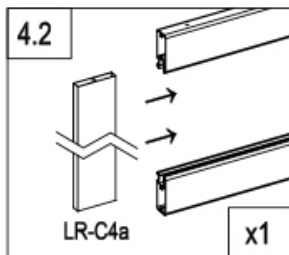
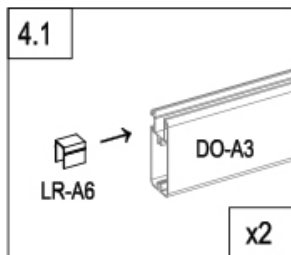
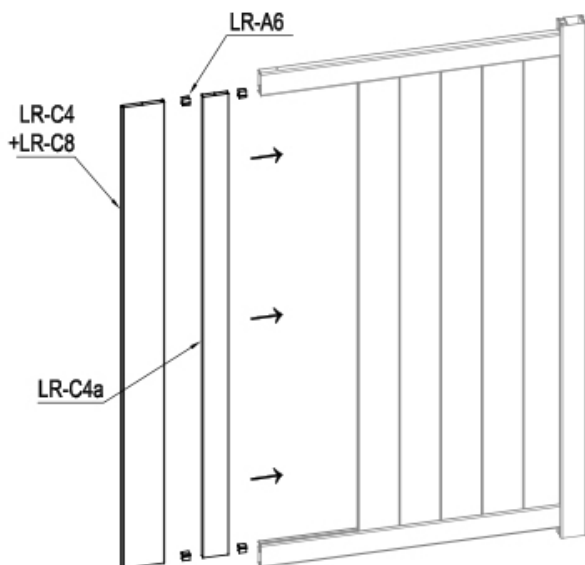

	LR-C4	4
---	-------	---



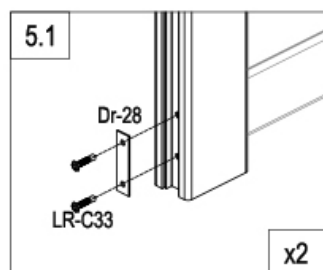
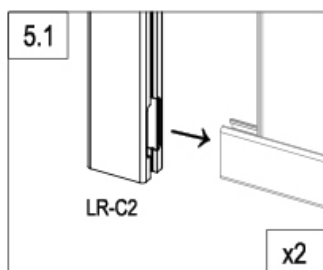
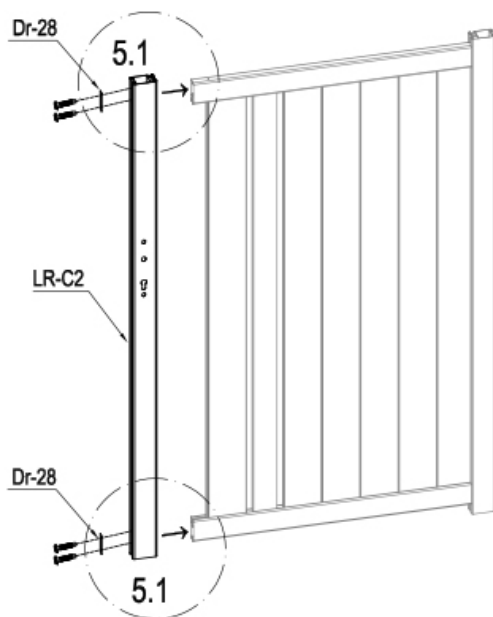

	LR-C4a	1
	LR-A6	4

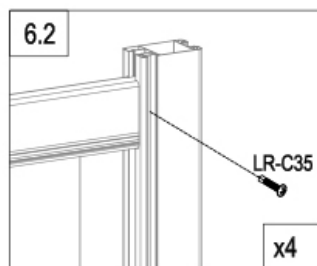
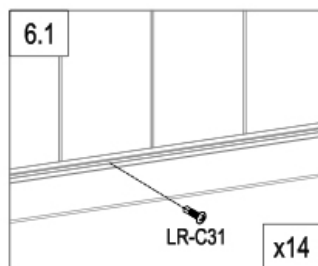
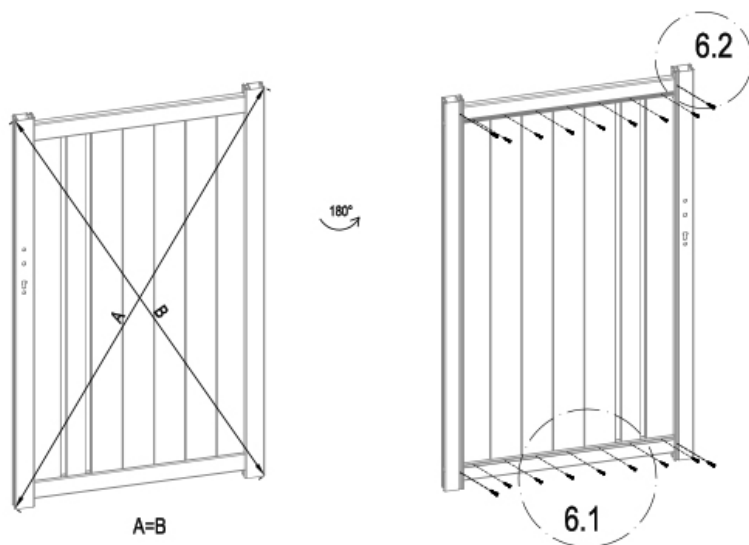

	LR-C2	1
	Dr-28	2
	LR-C33	4



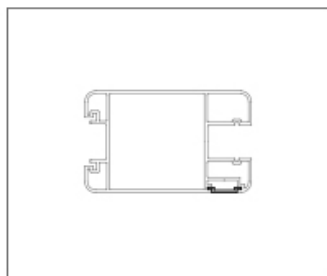
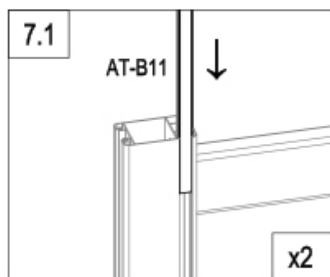
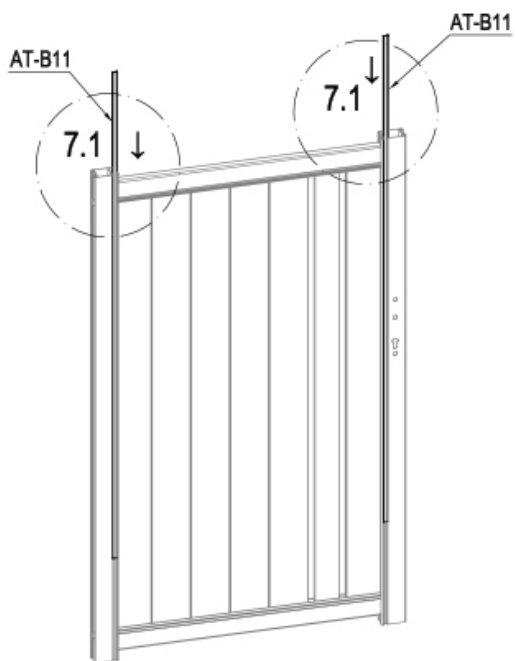

	LR-C31	14
	LR-C35	4

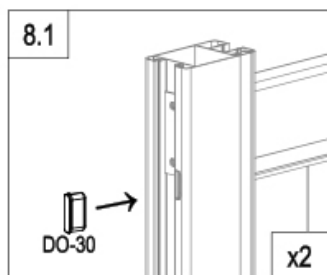
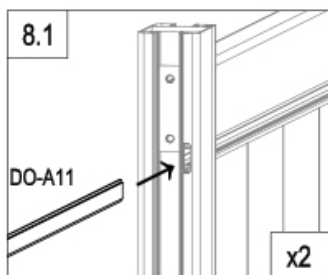
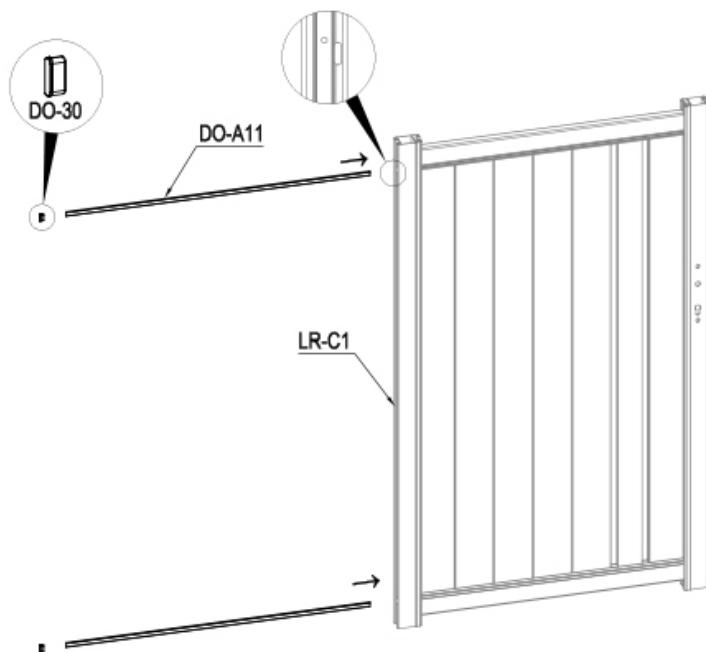

	AT-B11	2
---	--------	---



	DO-A11	2
	DO-30	2

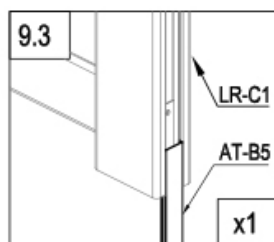
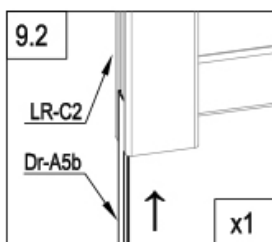
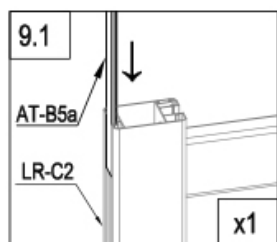
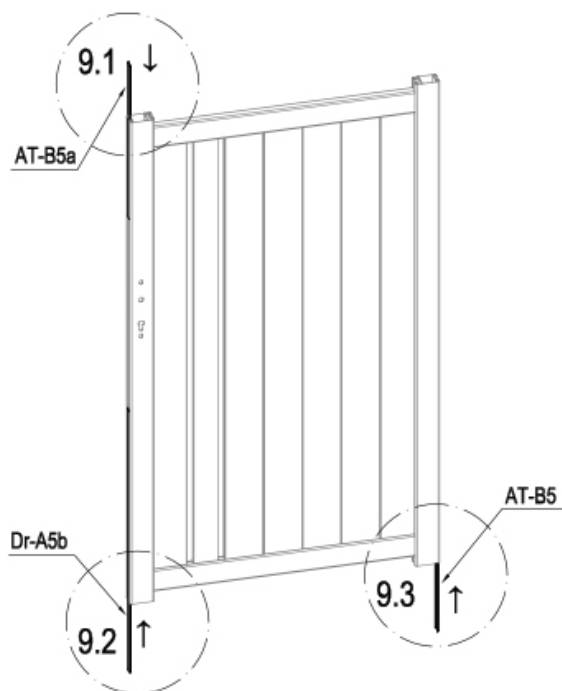

	AT-B5	1
	AT-B5a	1
	Dr-A5b	1

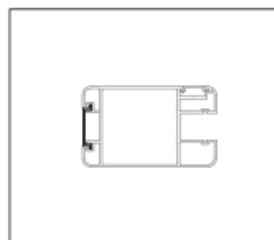

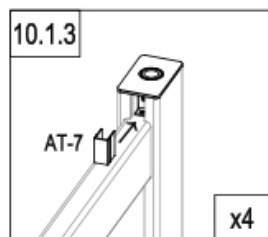
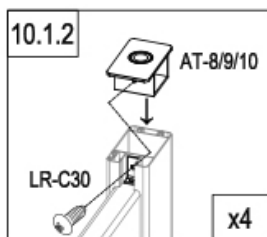
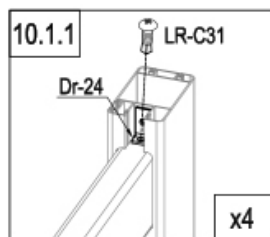
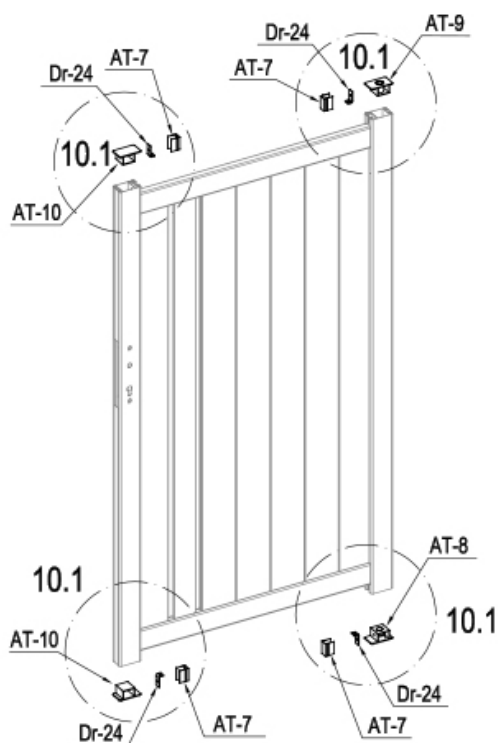

	AT-8	1
	AT-9	1
	AT-10	2
	Dr-24	4

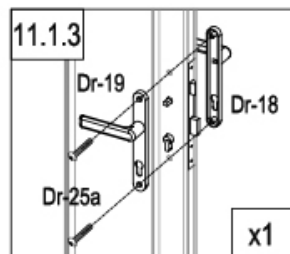
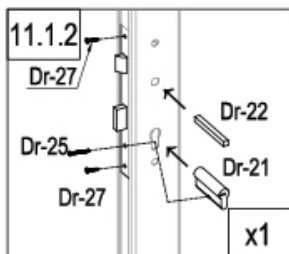
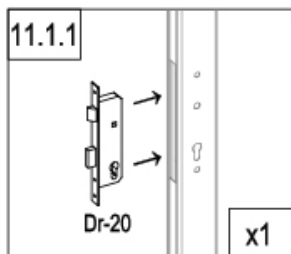
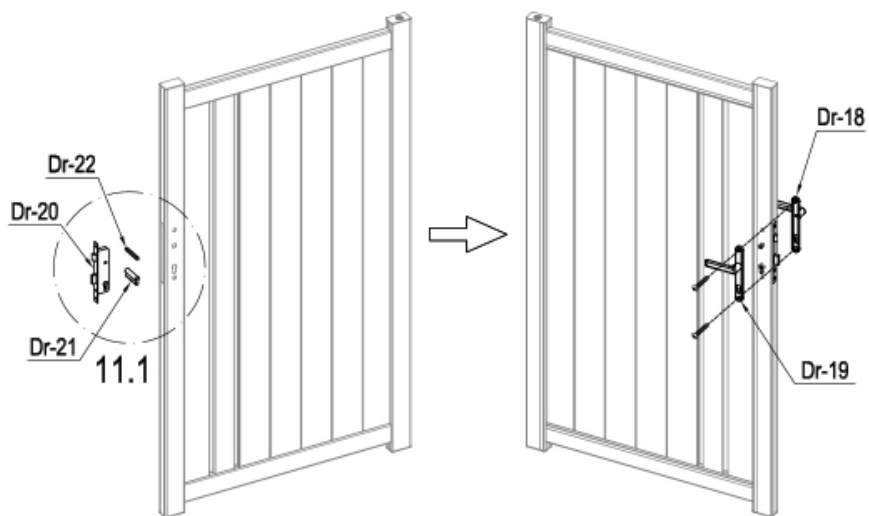

	AT-7	4
	LR-C30	4
	LR-C31	4

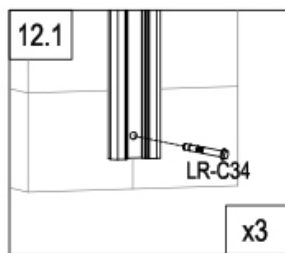
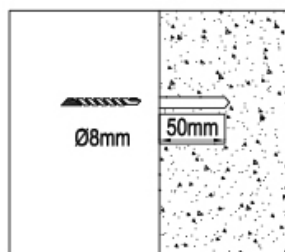
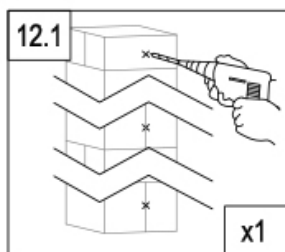
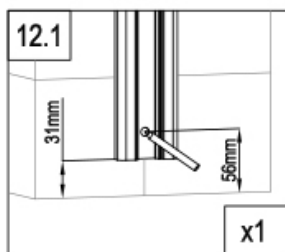
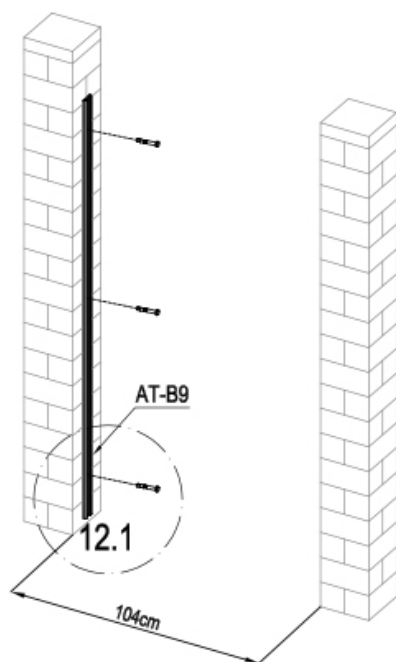

	Dr-20	1
	Dr-21	1
	Dr-22	1
	Dr-25	1

	Dr-18	1
	Dr-19	1
	Dr-25a	2
	Dr-27	2



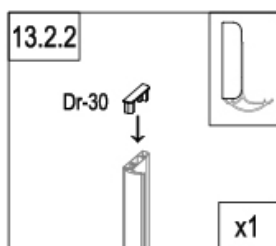
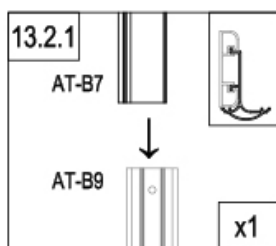
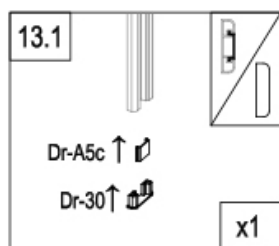
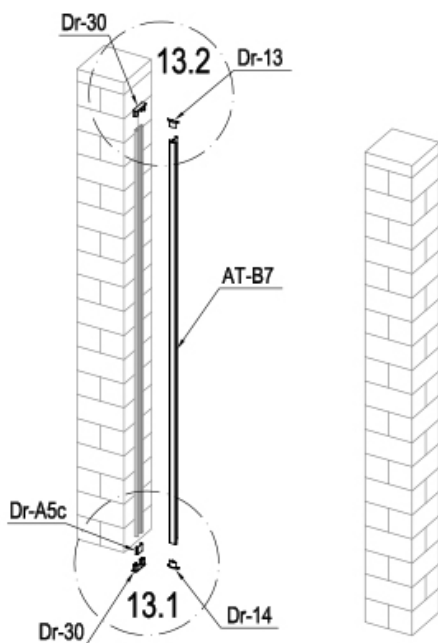

	AT-B9	1
	LR-C34	3



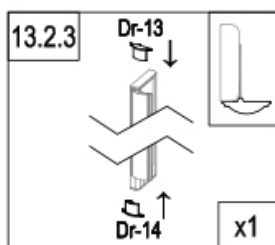

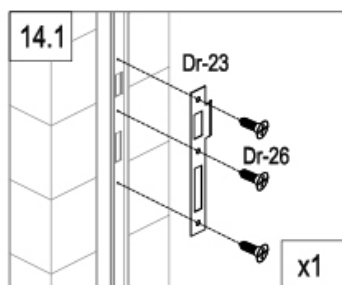
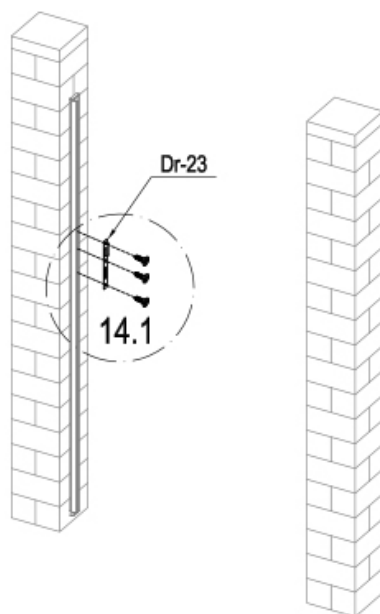
	AT-B7	1
	Dr-13	1
	Dr-14	1
	Dr-30	2
	Dr-A5c	1





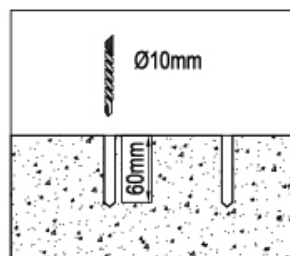
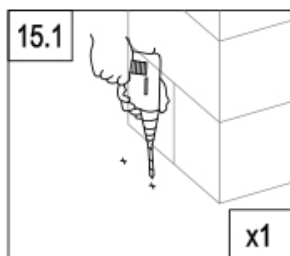
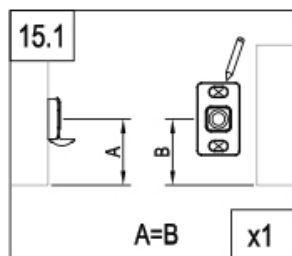
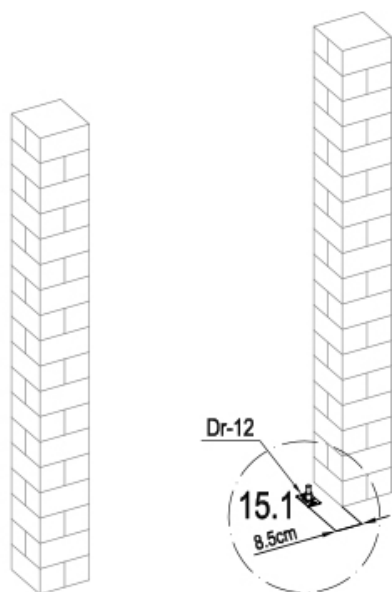

	Dr-23	1
	Dr-26	3

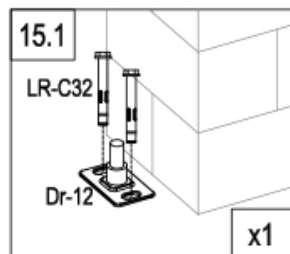

	Dr-12	1
	LR-C32	2

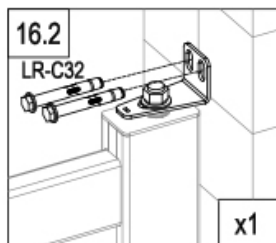
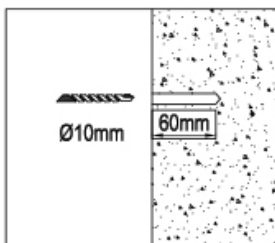
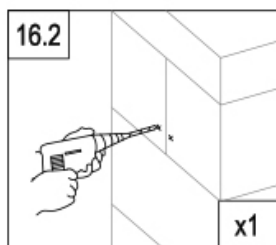
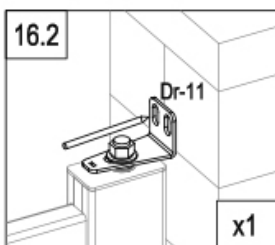
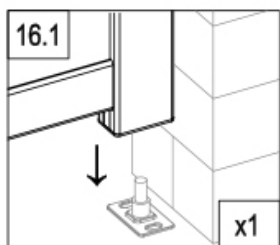
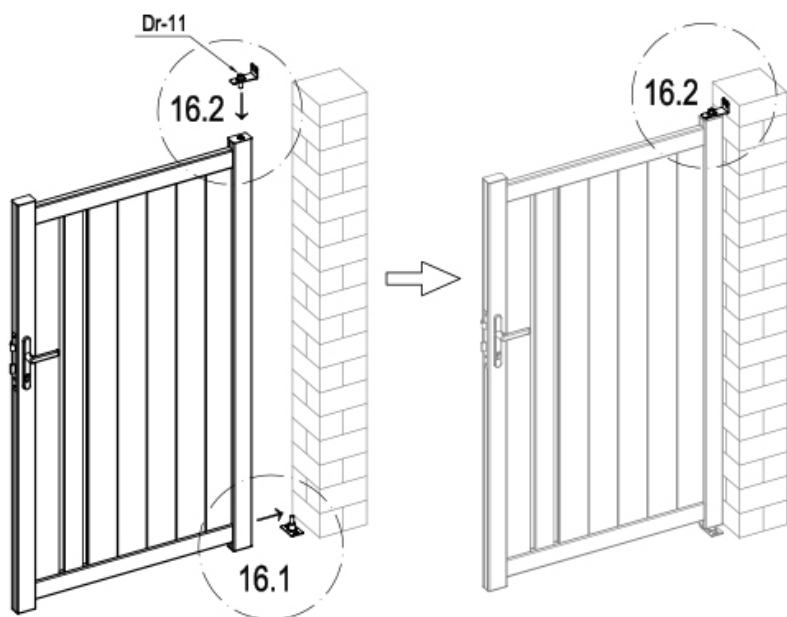





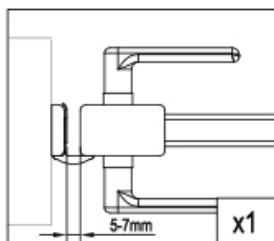
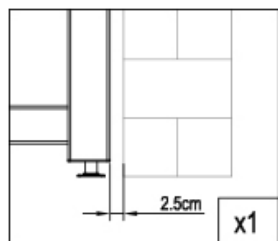
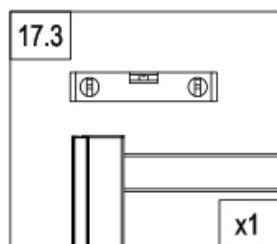
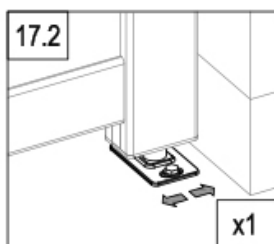
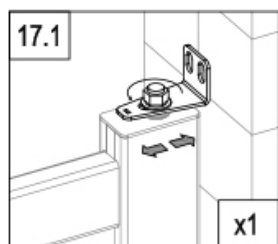
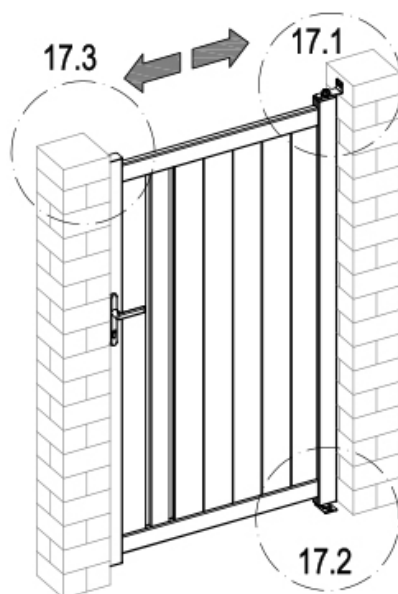

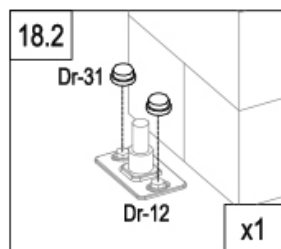
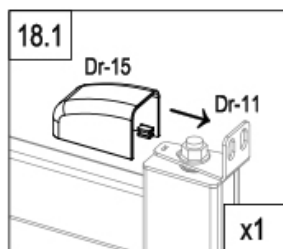
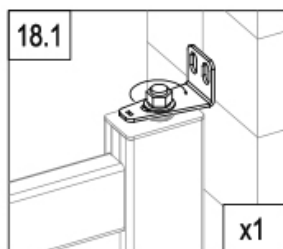
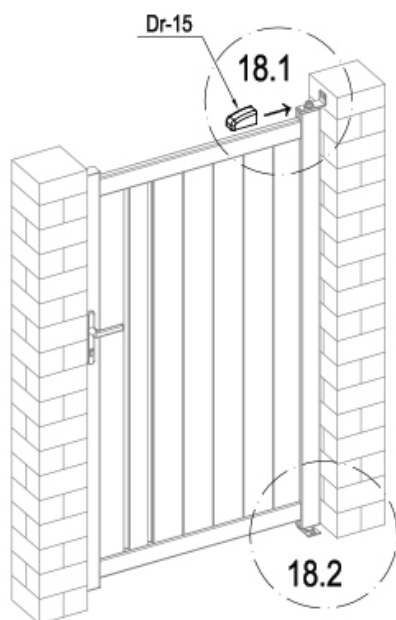
	Dr-11	1
	LR-C32	2



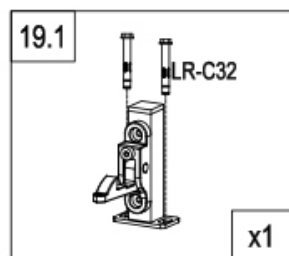
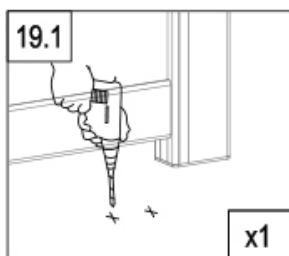
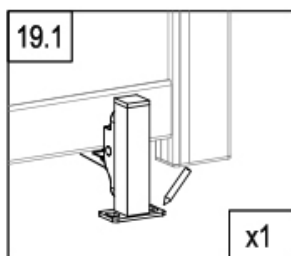
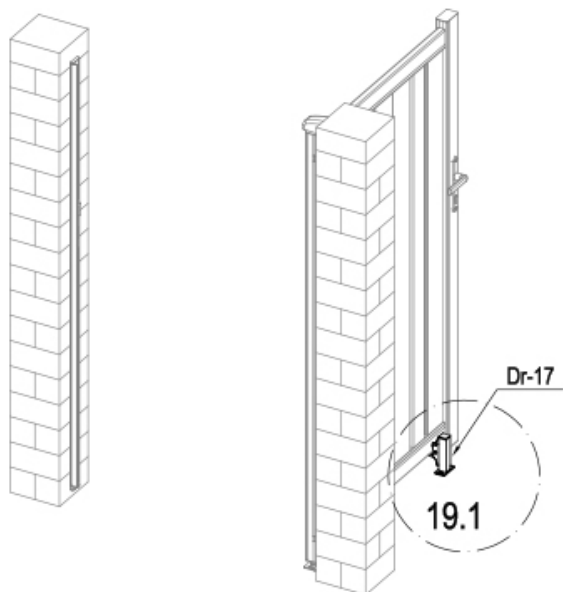

	Dr-15	1
	Dr-31	2



	LR-C32	2
	Dr-17	1

