

CASANOVO

GIONA 100P140

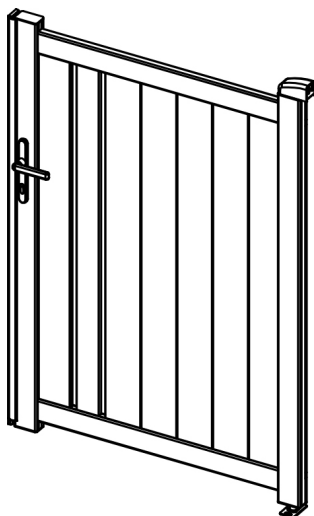

STI-000181 [x1]



3-5H



X 2



INSTRUCTION MANUAL / NOTICE DE MONTAGE / MONTAGEANLEITUNG / MANUAL DE MONTAJE / MANUAL DE MONTAGEM / MANUALE DI MONTAGGIO /
MONTAGEHANDLEIDING / INSTRUKCJA MONTAŻU / KÄYTTÖOHJEET / BRUKSANVISNING / BRUGSANVISNING / INSTRUCȚIUNI DE ASAMBLARE /
NAVODILA ZA SESTAVLJANJE / NÁVOD NA MONTÁŽ / ÖSSZESZERELÉSI ÚTMUTATÓ / NÁVOD K MONTÁŽI / UPUTE ZA INSTALACIJU /
ΟΔΗΓΙΕΣ ΣΥΝΑΡΜΟΛΟΓΗΣΗΣ / SURINKIMO INSTRUKCIJOS / MONTĀŽAS INSTRUKCIJAS

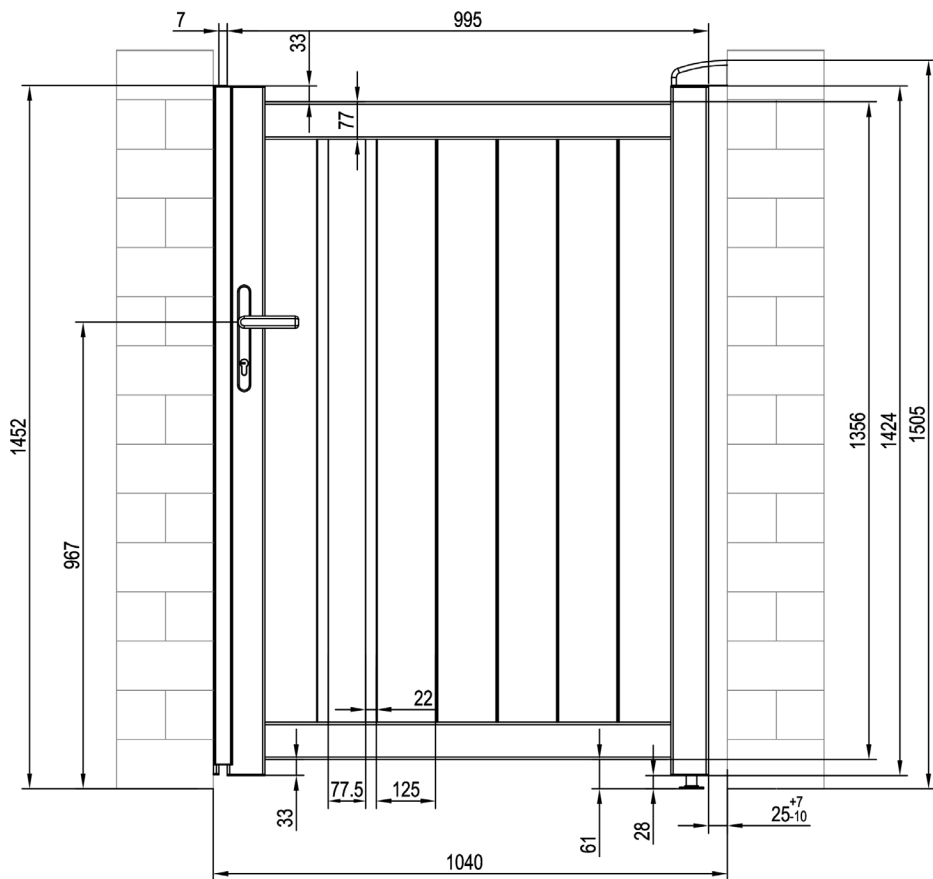

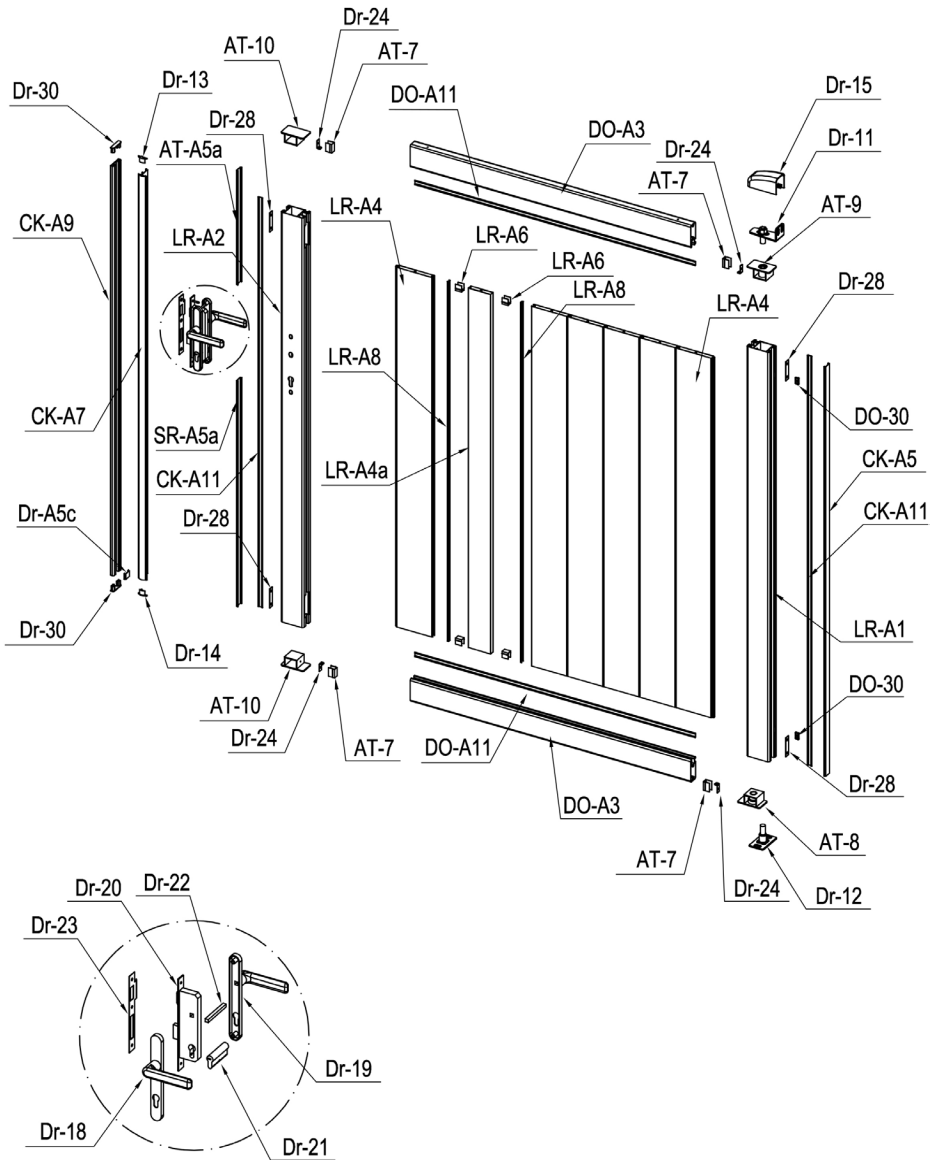







































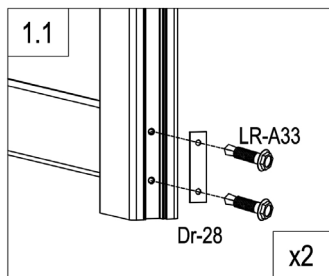
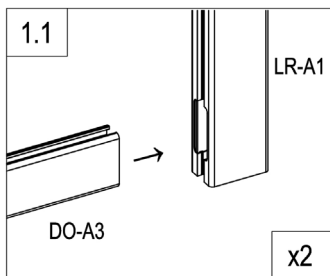
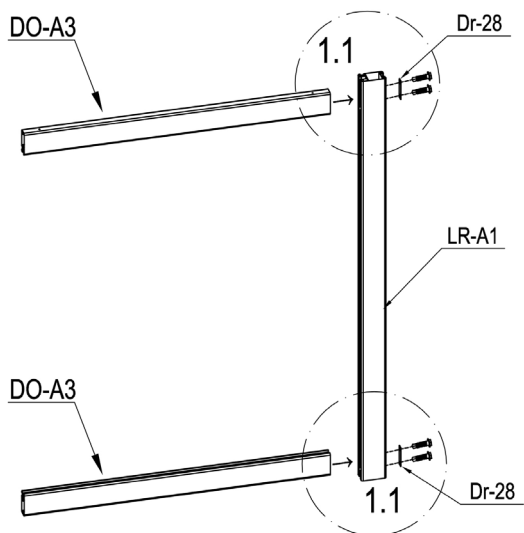



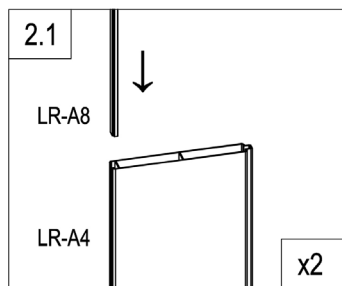
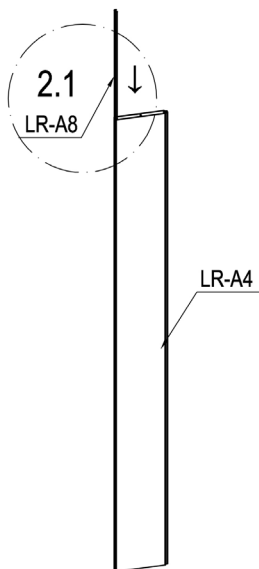



IMAGE	NO.	L.(mm)	QTY	IMAGE	NO.	L.(mm)	QTY
	LR-A1	1418	1		Dr-15		1
	LR-A2	1418	1		Dr-17		1
	DO-A3	972	2		Dr-30		2
	LR-A4	1245	6		Dr-31		2
	LR-A4a	1245	1		Dr-18		1
	CK-A5	1418	1		Dr-19		1
	AT-A5a	395.5	1		Dr-20		1
	SR-A5a	782	1		Dr-21		1
	Dr-A5c	19.5	1		Dr-22		1
	CK-A11	1418	2		Dr-23		1
	DO-A11	972	2		Dr-24		4
	AT-7	29.5	4		Dr-28		4
	LR-A6	21	4		DO-30		2
	LR-A8	1245	2		Dr-25		1
	CK-A7	1398	1		Dr-25a		2
	CK-A9	1418	1		Dr-26		3
	AT-8		1		Dr-27		2
	AT-9		1		LR-A30		4
	AT-10		2		LR-A31		18
	Dr-11		1		LR-A32		6
	Dr-12		1		LR-A33		8
	Dr-13		1		LR-A34		3
	Dr-14		1		LR-A35		4





	LR-A1	1
	DO-A3	2
	Dr-28	2
	LR-A33	4



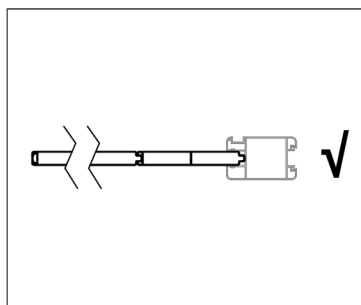
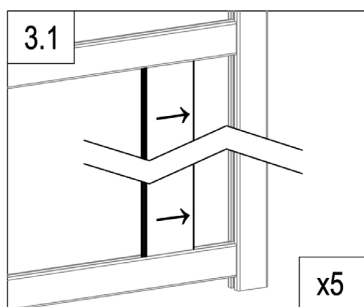
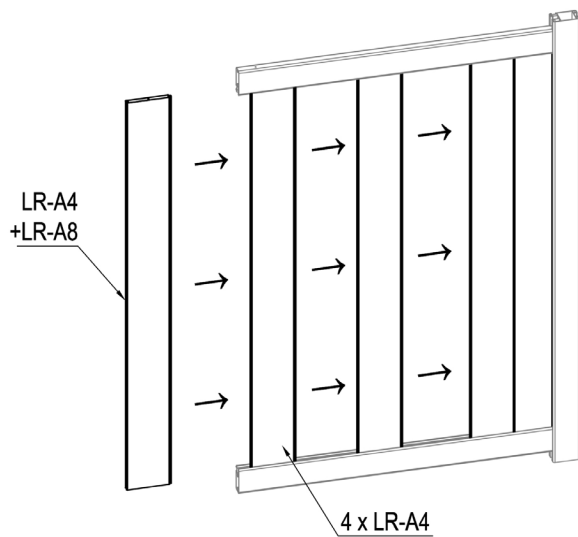

X2

	LR-A8	2
	LR-A4	2



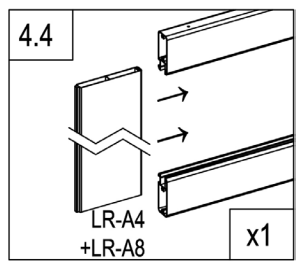
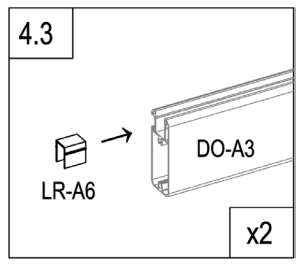
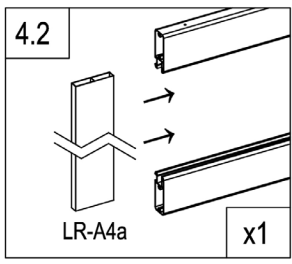
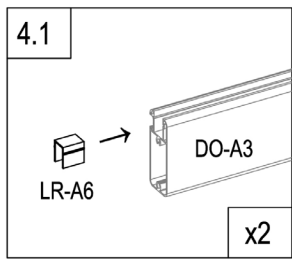
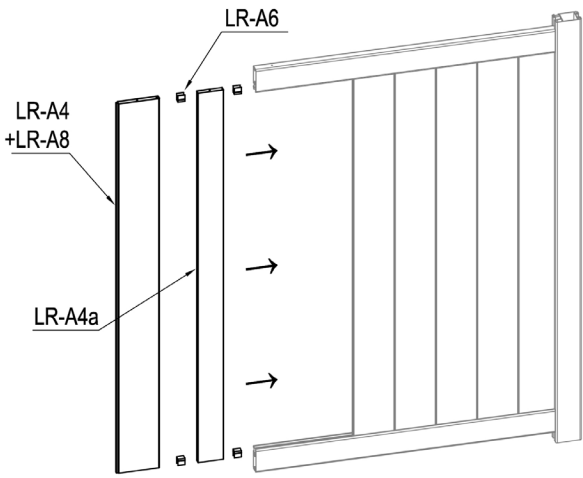

	LR-A4	4
---	-------	---



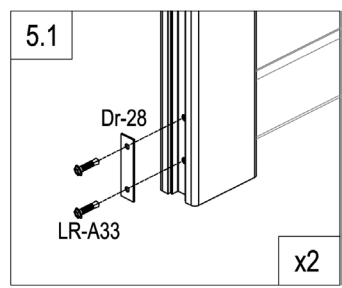
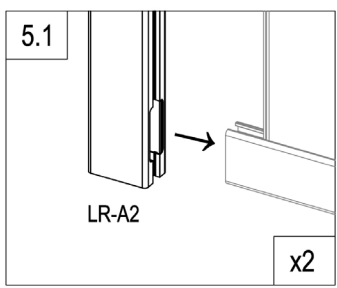
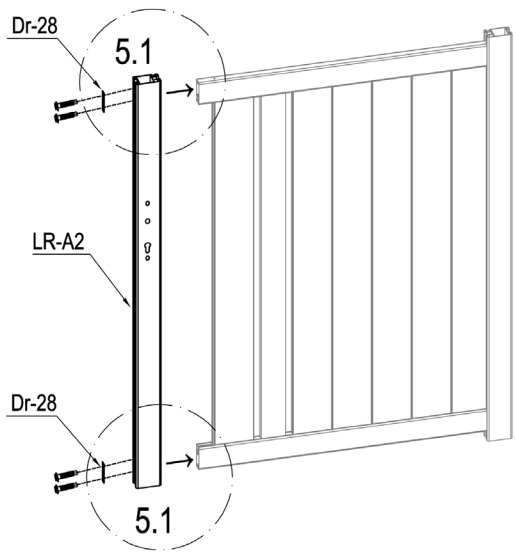

	LR-A4a	1
	LR-A6	4

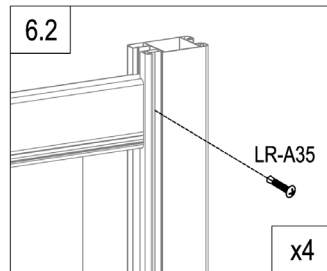
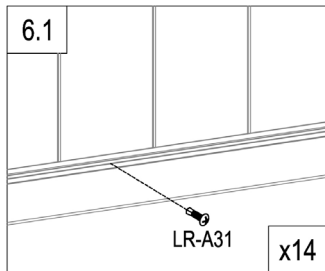
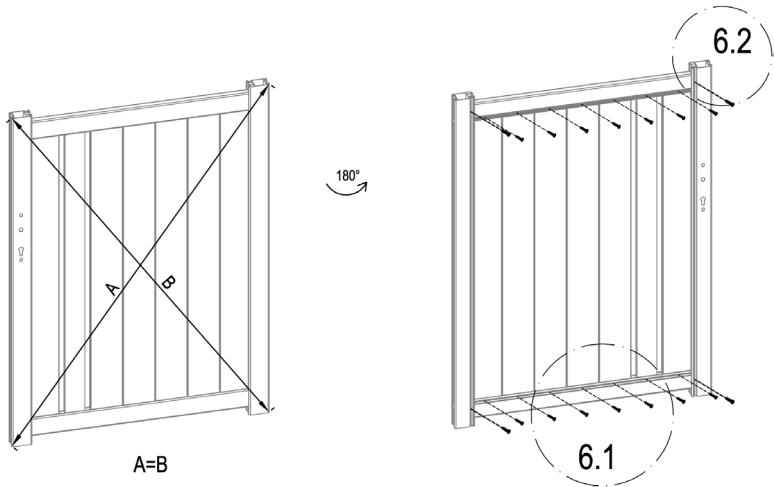

	LR-A2	1
	Dr-28	2
	LR-A33	4



	LR-A31	14
	LR-A35	4

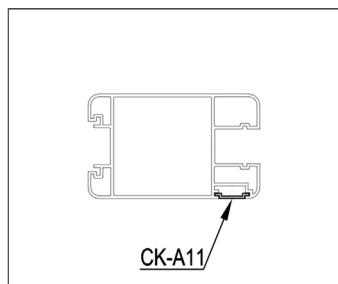
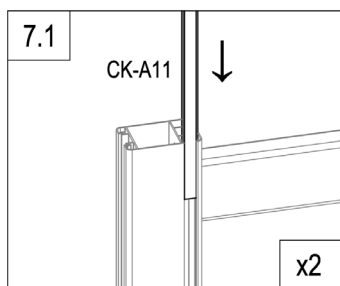
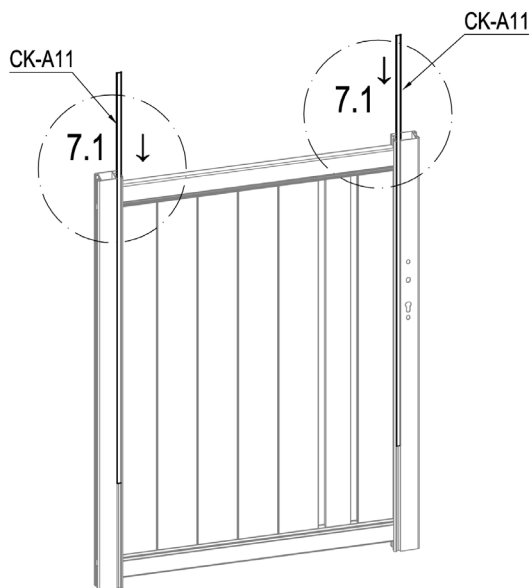

	CK-A11	2
---	--------	---

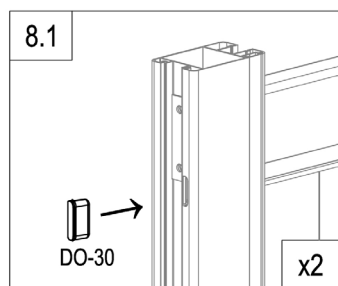
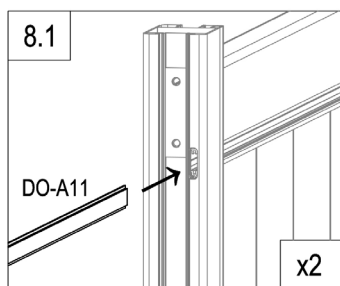
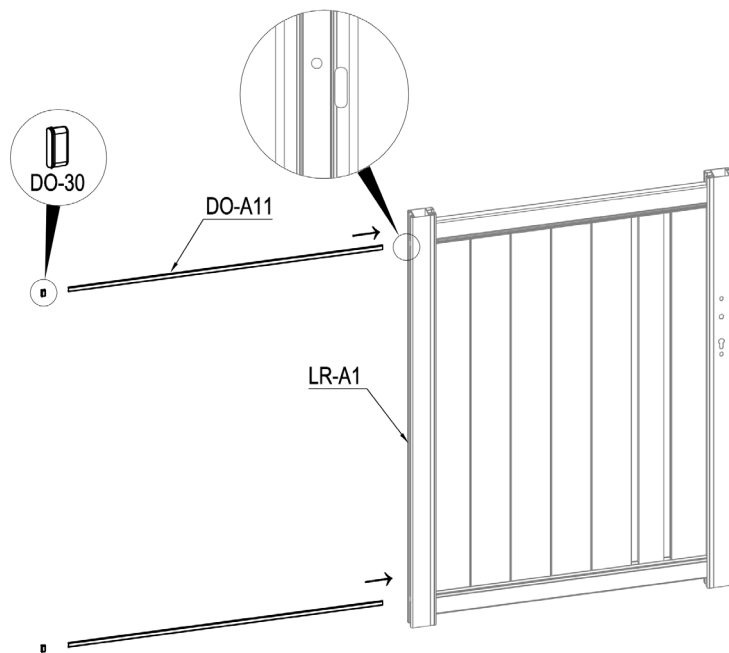

	DO-A11	2
---	--------	---

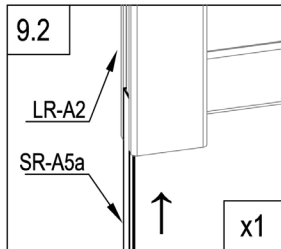
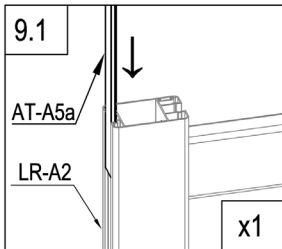
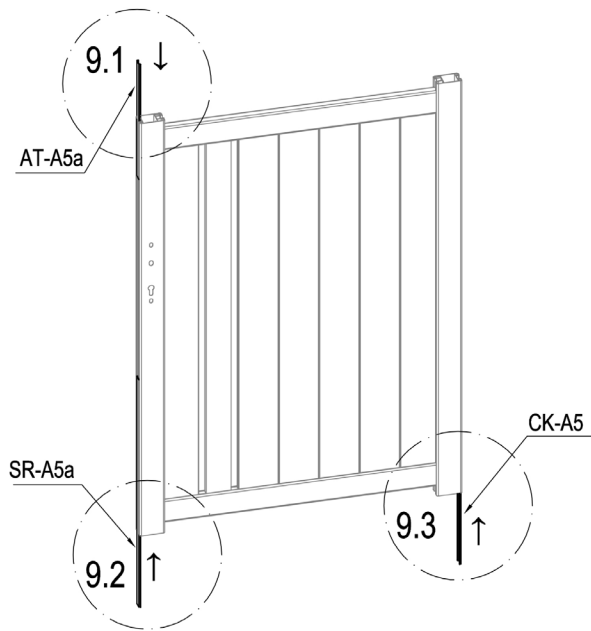

	CK-A5	1
	AT-A5a	1
	SR-A5a	1

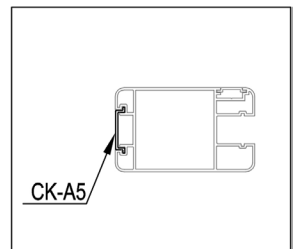

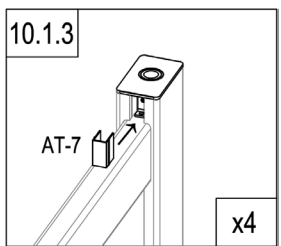
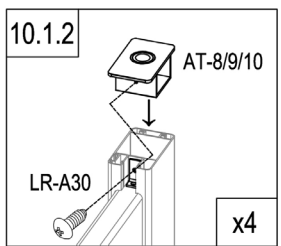
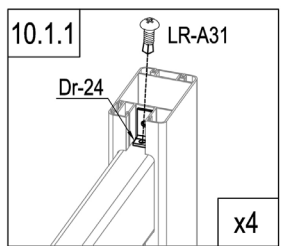
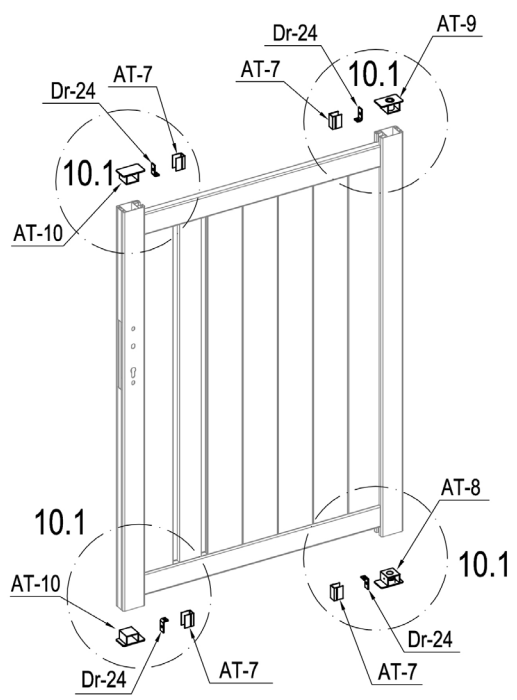

	AT-8	1
	AT-9	1
	AT-10	2
	Dr-24	4

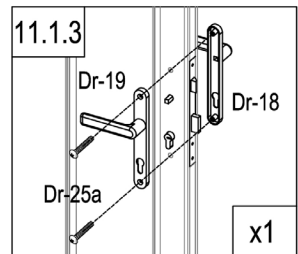
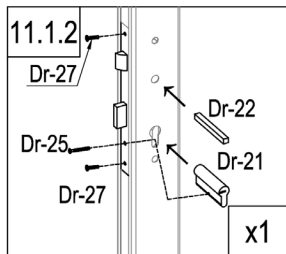
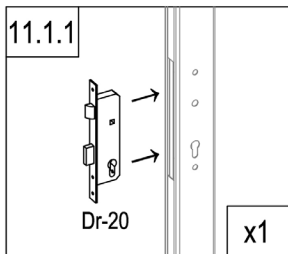
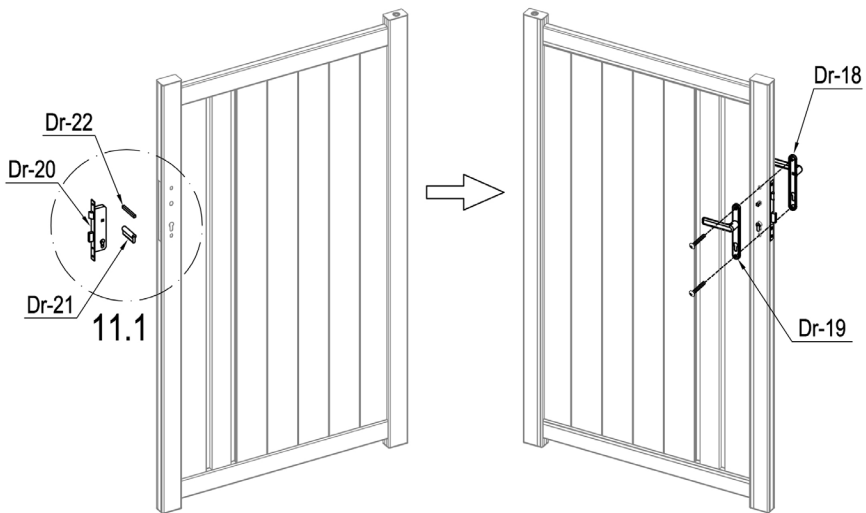

	AT-7	4
	LR-A30	4
	LR-A31	4

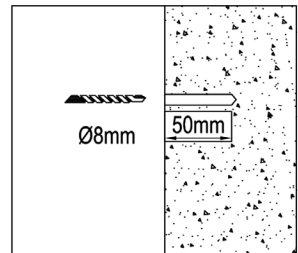
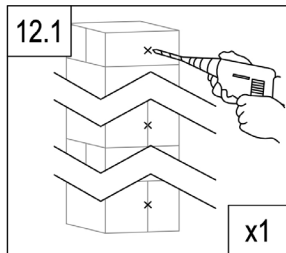
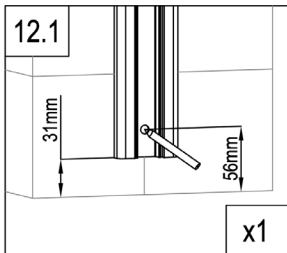
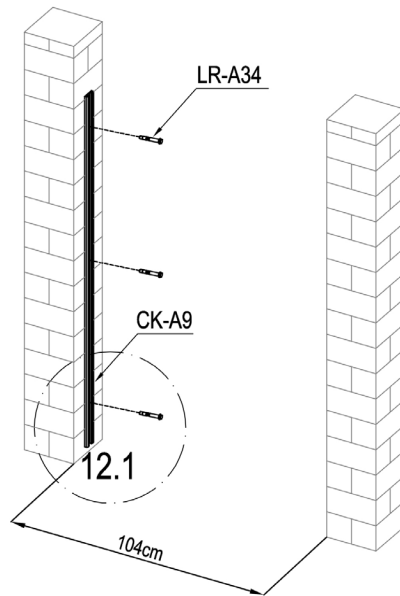

	Dr-20	1
	Dr-21	1
	Dr-22	1
	Dr-25	1

	Dr-18	1
	Dr-19	1
	Dr-25a	2
	Dr-27	2



	CK-A9	1
	LR-A34	3

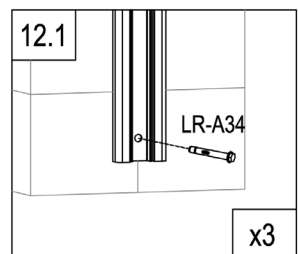

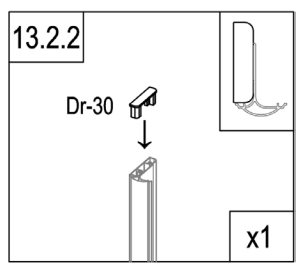
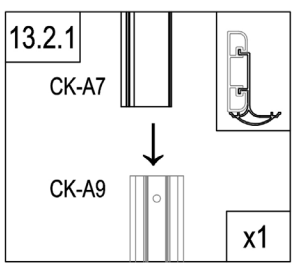
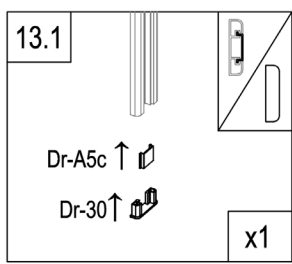
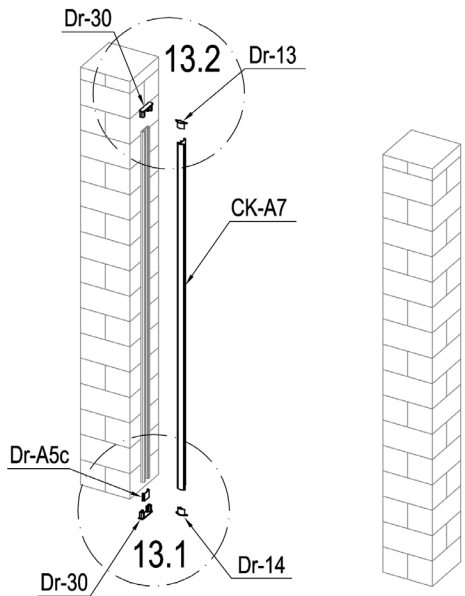



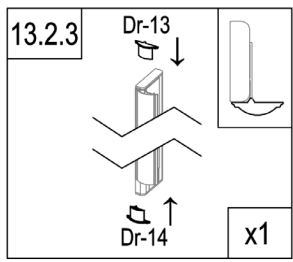

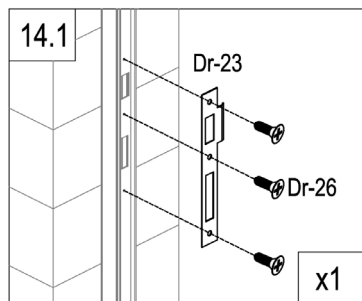
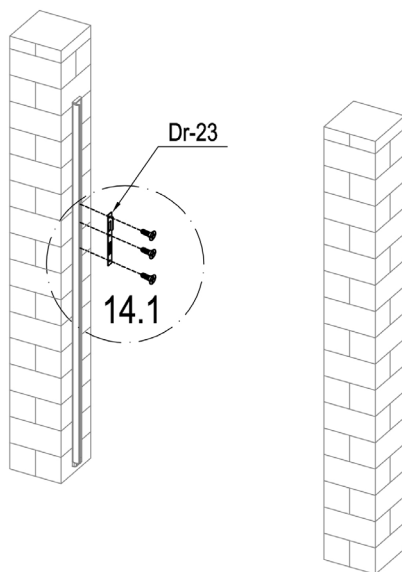
	CK-A7	1
	Dr-13	1
	Dr-14	1
	Dr-30	2
	Dr-A5c	1





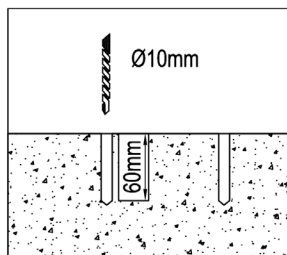
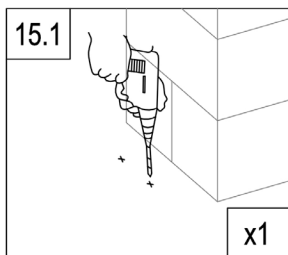
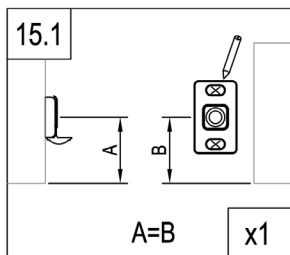
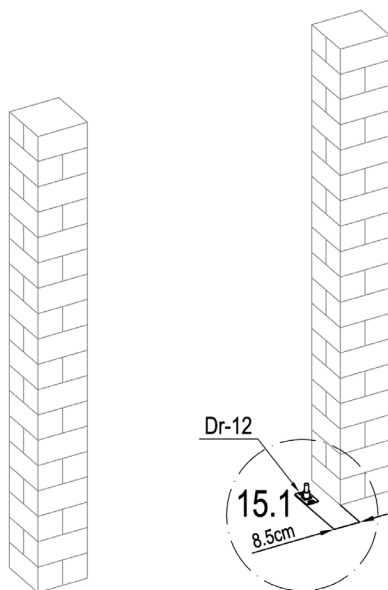

	Dr-23	1
	Dr-26	3

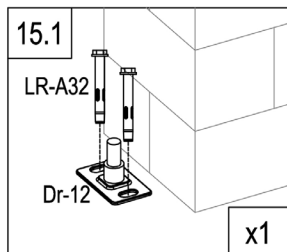

	Dr-12	1
	LR-A32	2

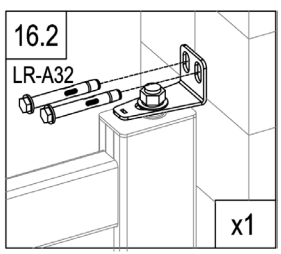
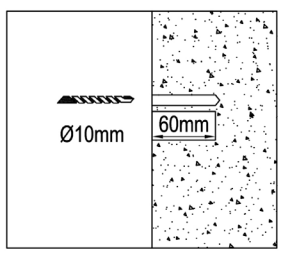
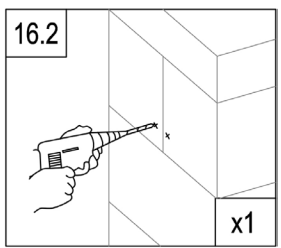
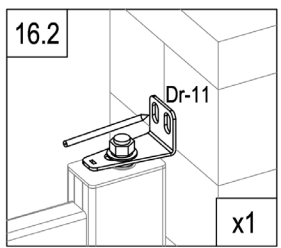
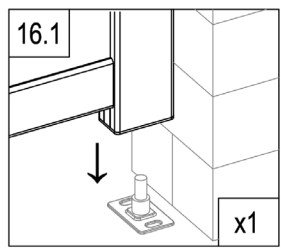
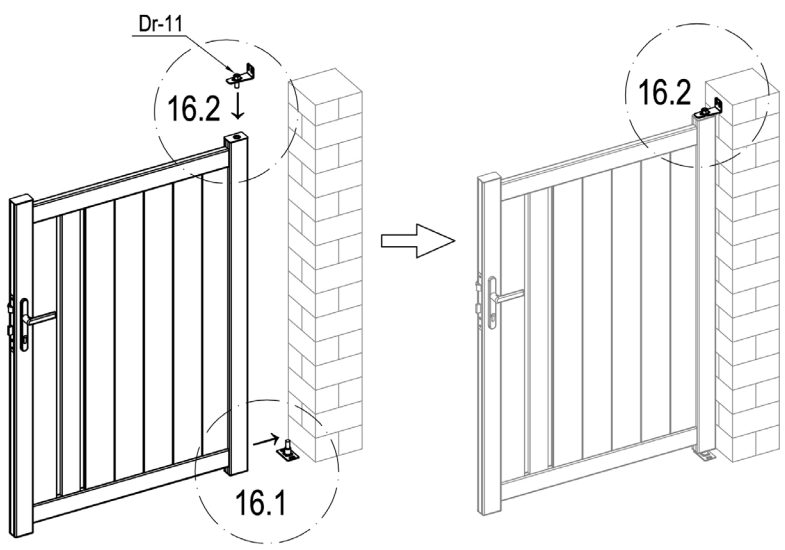





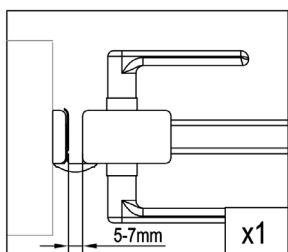
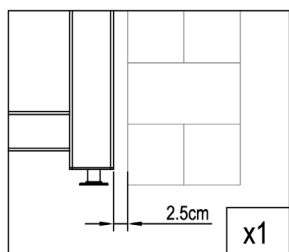
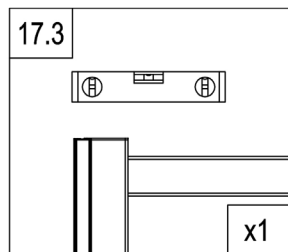
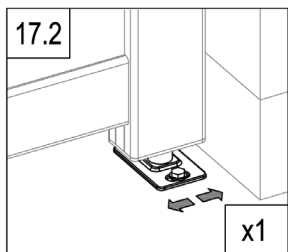
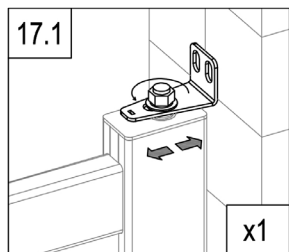
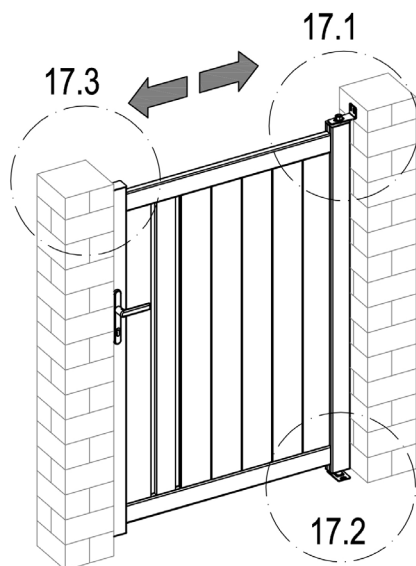

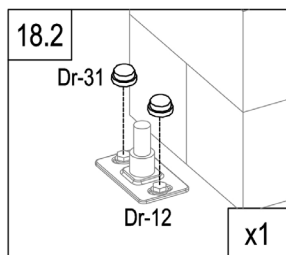
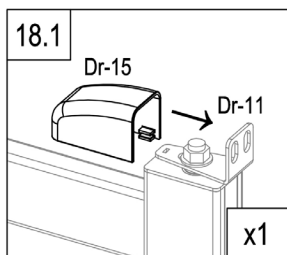
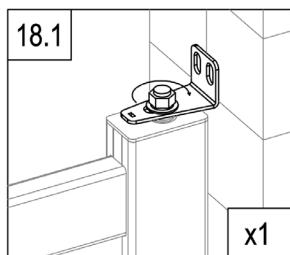
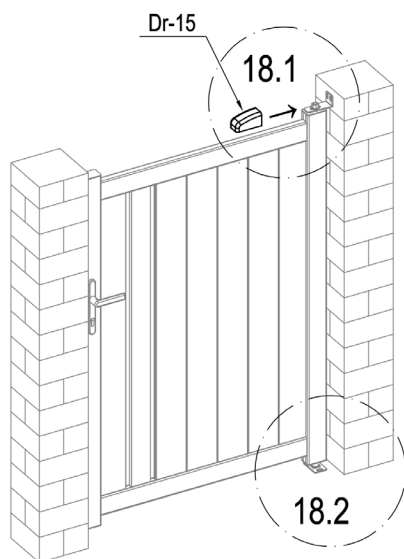
	Dr-11	1
	LR-A32	2



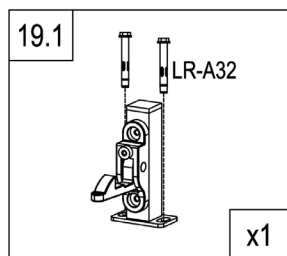
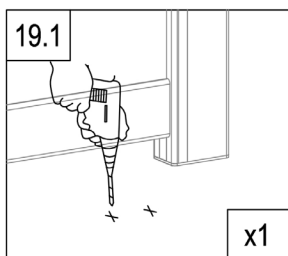
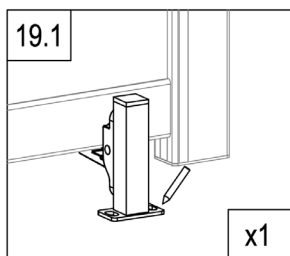
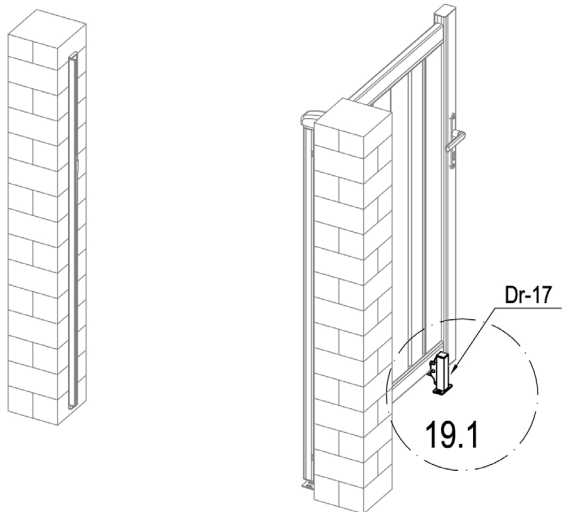

	Dr-15	1
	Dr-31	2



	LR-A32	2
	Dr-17	1

