

CASANOVO

GIONA 100P120

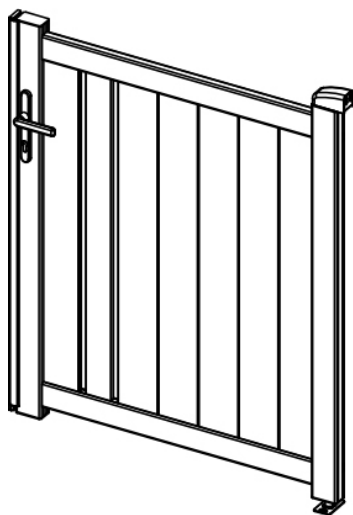

STI-000180 [x1]



INSTRUCTION MANUAL / NOTICE DE MONTAGE / MONTAGEANLEITUNG / MANUAL DE MONTAJE / MANUAL DE MONTAGEM / MANUALE DI MONTAGGIO /
MONTAGEHANDLEIDING / INSTRUKCJA MONTAŻU / KÄYTTÖOHJEET / BRUKSANVISNING / BRUGSANVISNING / INSTRUCIUNI DE ASAMBLARE /
NAVODILA ZA SESTAVLJANJE / NÁVOD NA MONTÁŽ / ÖSSZESZERELÉSI ÚTMUTATÓ / NÁVOD K MONTÁŽI / UPUTE ZA INSTALACIJU /
ΟΔΗΓΙΕΣ ΣΥΝΑΡΜΟΛΟΓΗΣΗΣ / SURINKIMO INSTRUKCIJOS / MONTÁŽAS INSTRUKCIJAS

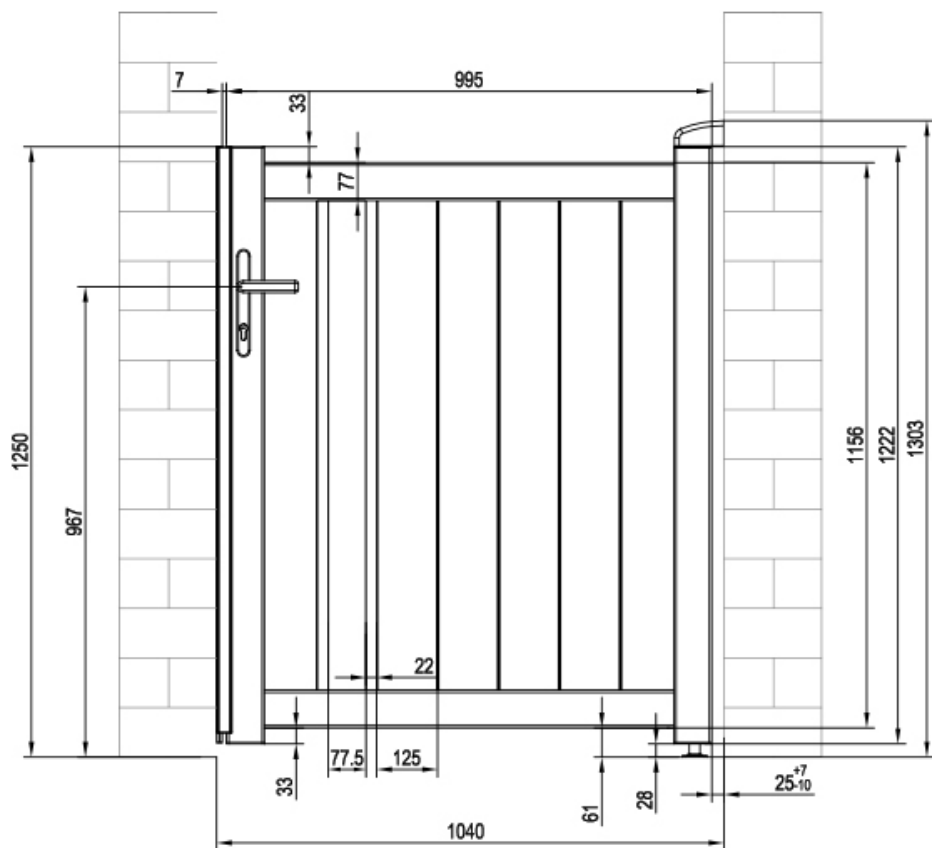

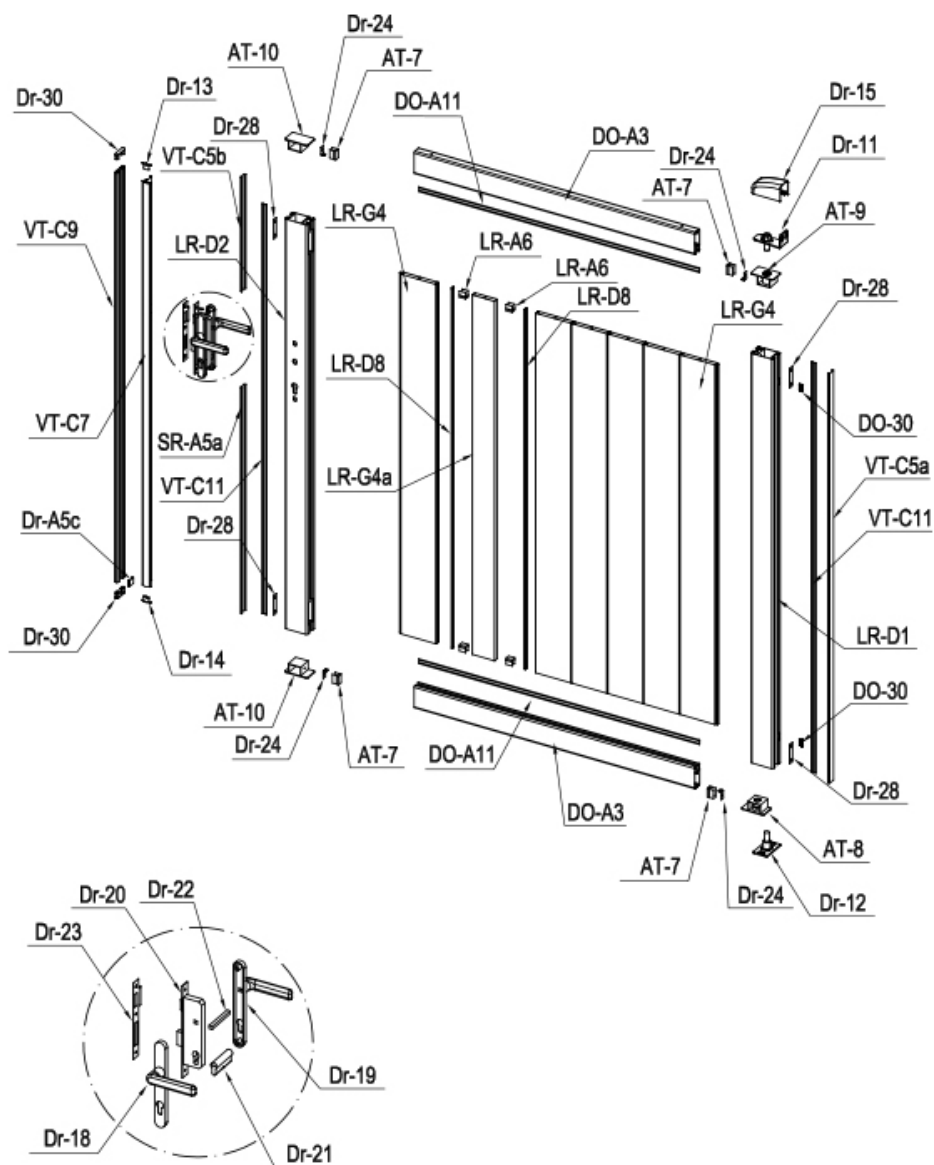







































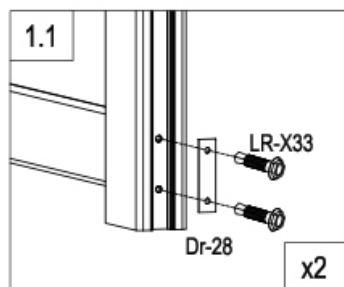
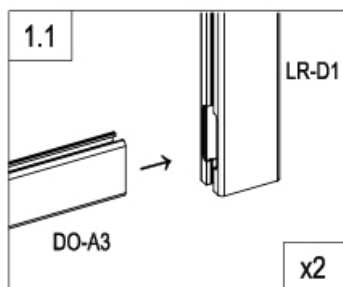
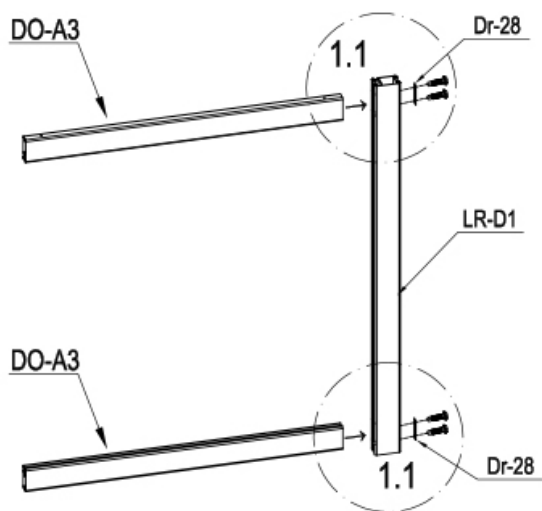



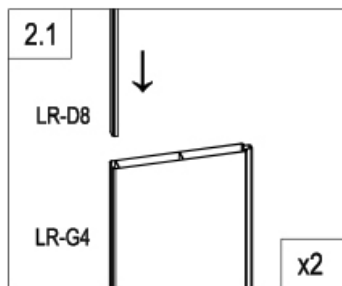
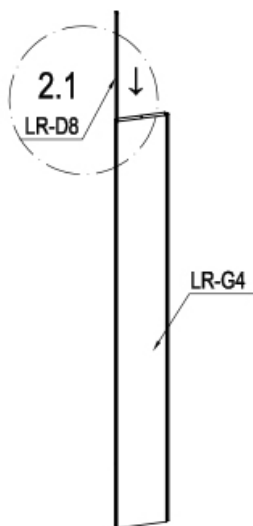



IMAGE	NO.	L.(mm)	QTY	IMAGE	NO.	L.(mm)	QTY
	LR-D1	1217	1		Dr-15		1
	LR-D2	1217	1		Dr-17		1
	DO-A3	972	2		Dr-30		2
	LR-G4	1044	6		Dr-31		2
	LR-G4a	1044	1		Dr-18		1
	VT-C5a	1217	1		Dr-19		1
	VT-C5b	194.5	1		Dr-20		1
	SR-A5a	782	1		Dr-21		1
	Dr-A5c	19.5	1		Dr-22		1
	VT-C11	1217	2		Dr-23		1
	DO-A11	972	2		Dr-24		4
	AT-7	29.5	4		Dr-28		4
	LR-A6	21	4		DO-30		2
	LR-D8	1044	2		Dr-25		1
	VT-C7	1197	1		Dr-25a		2
	VT-C9	1217	1		Dr-26		3
	AT-8		1		Dr-27		2
	AT-9		1		LR-X30		4
	AT-10		2		LR-X31		18
	Dr-11		1		LR-X32		6
	Dr-12		1		LR-X33		8
	Dr-13		1		LR-X34		3
	Dr-14		1		LR-X35		4



	LR-D1	1
	DO-A3	2
	Dr-28	2
	LR-X33	4



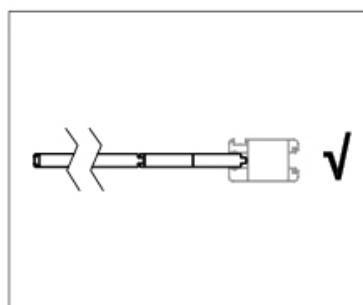
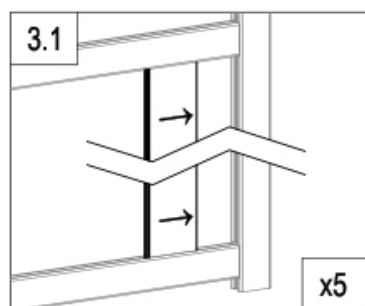
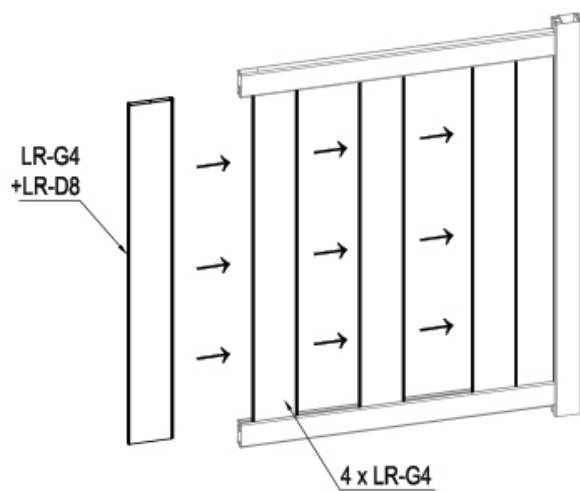

X2

	LR-D8	2
	LR-G4	2



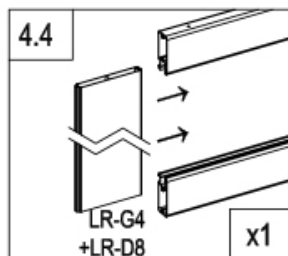
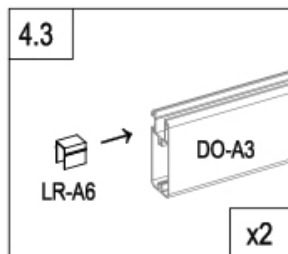
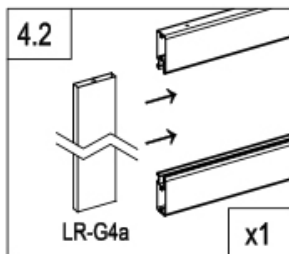
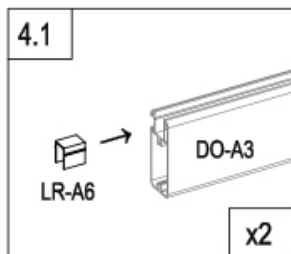
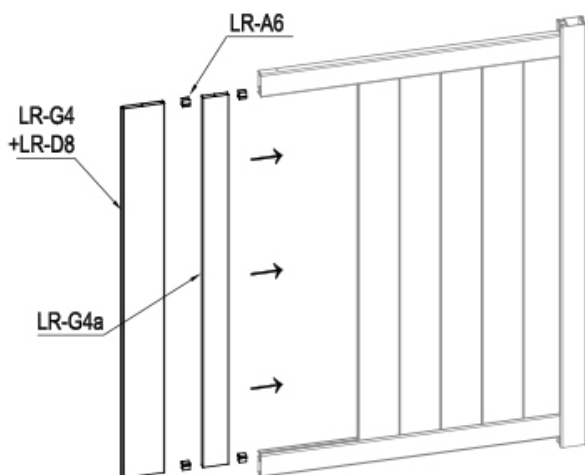

	LR-G4	4
---	-------	---

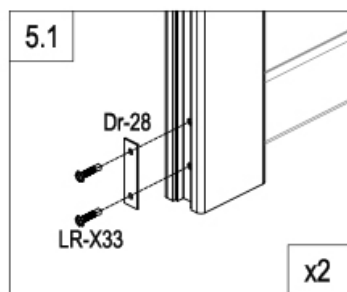
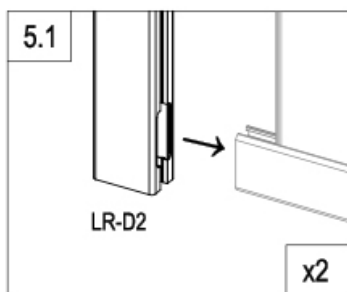
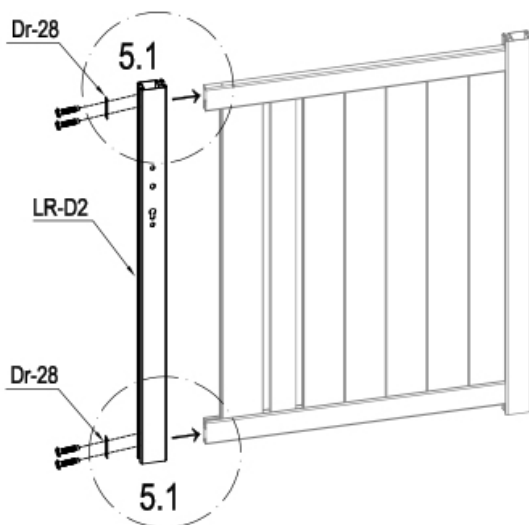

	LR-G4a	1
	LR-A6	4





	LR-D2	1
	Dr-28	2
	LR-X33	4



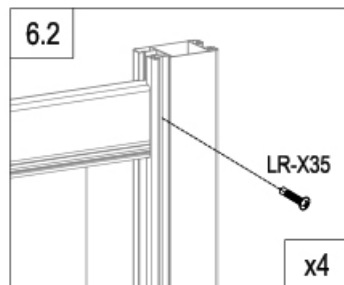
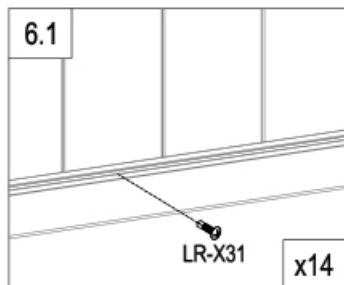

A=B

180°



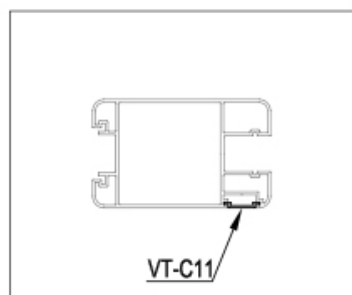
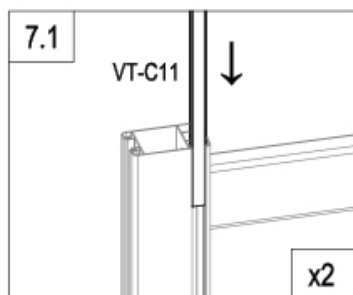
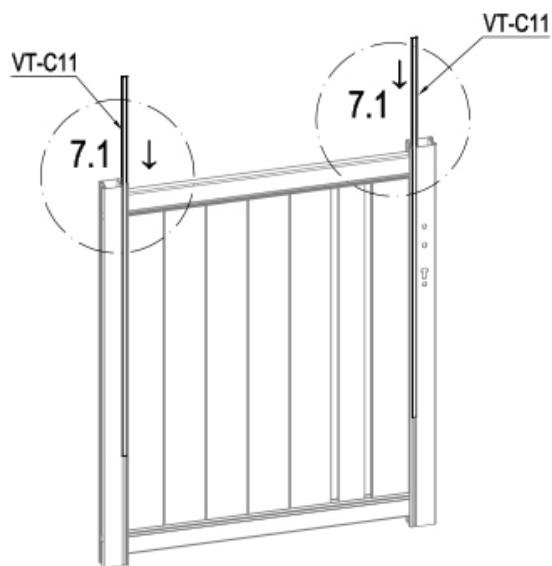

	LR-X31	14
	LR-X35	4

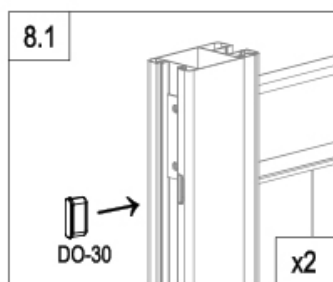
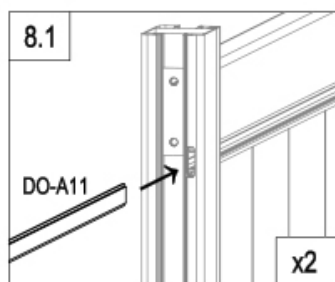
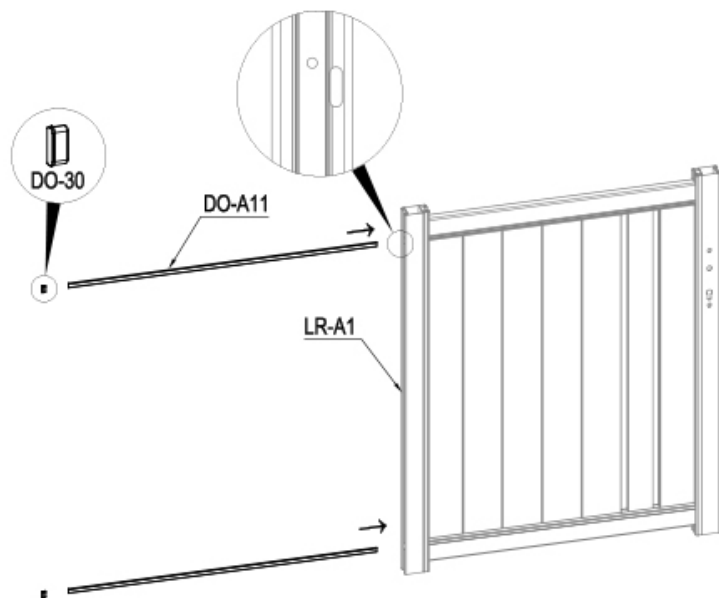

	VT-C11	2
---	--------	---



	DO-A11	2
	DO-30	2

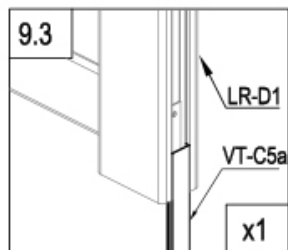
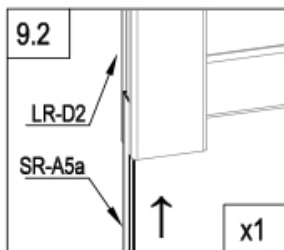
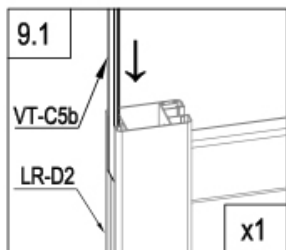
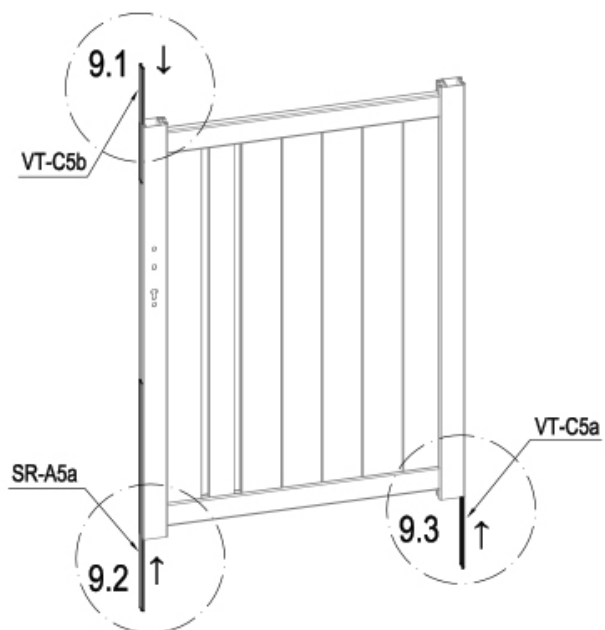

	VT-C5a	1
	VT-C5b	1
	SR-A5a	1

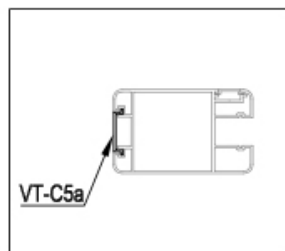

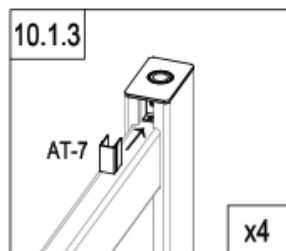
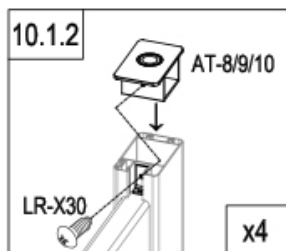
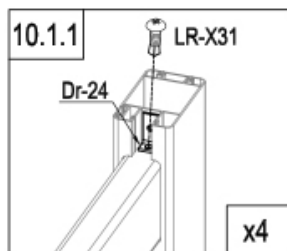
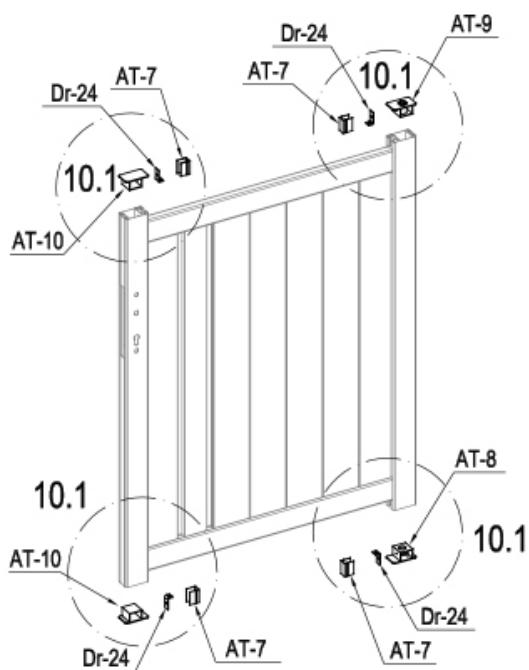

	AT-8	1
	AT-9	1
	AT-10	2
	Dr-24	4

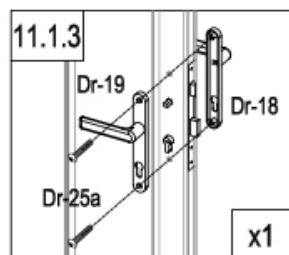
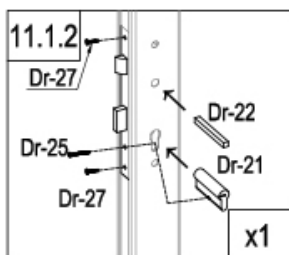
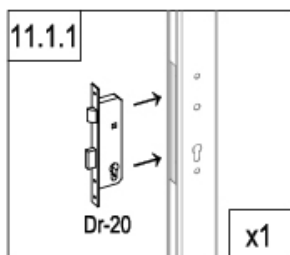
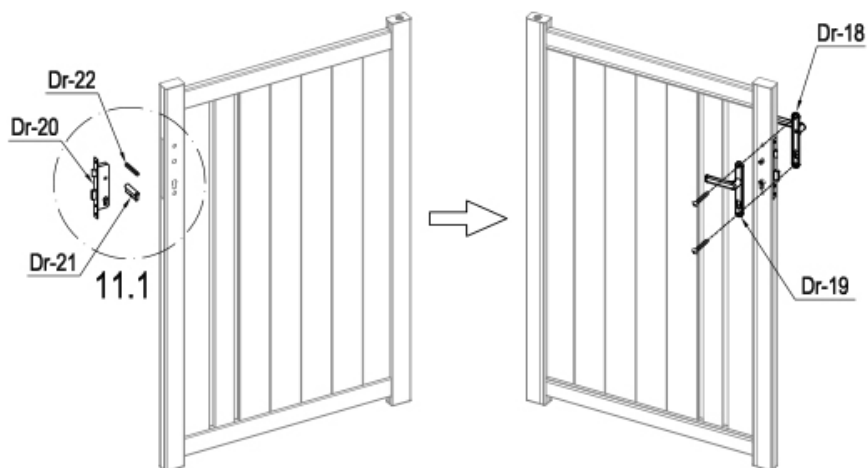

	AT-7	4
	LR-X30	4
	LR-X31	4

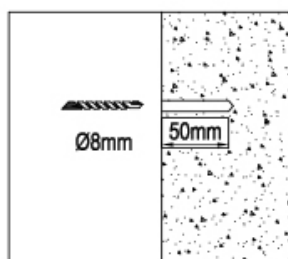
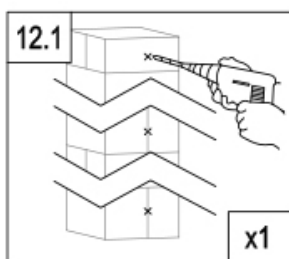
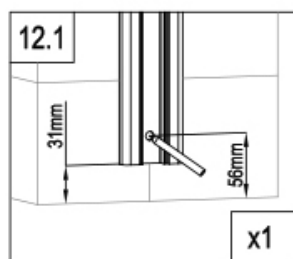
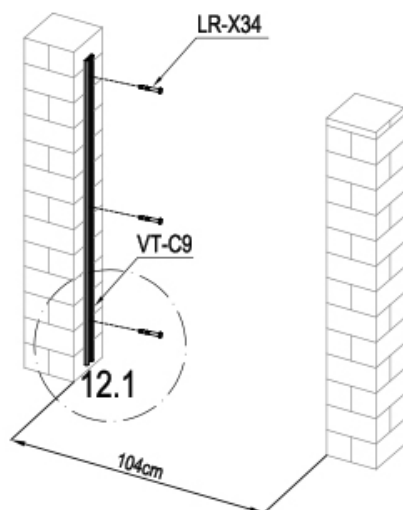

	Dr-20	1
	Dr-21	1
	Dr-22	1
	Dr-25	1

	Dr-18	1
	Dr-19	1
	Dr-25a	2
	Dr-27	2



	VT-C9	1
	LR-X34	3

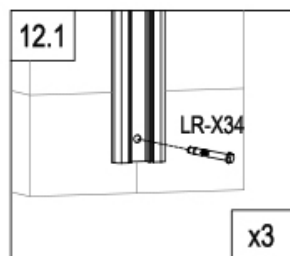

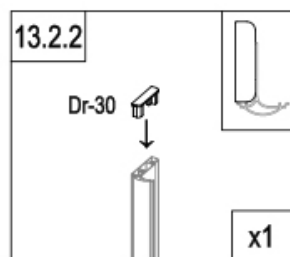
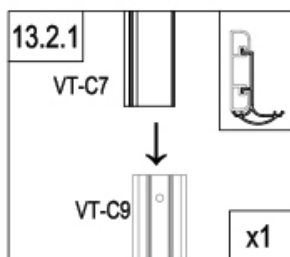
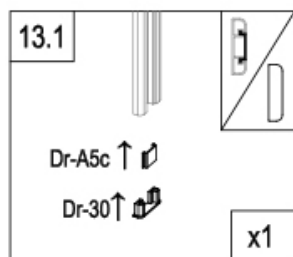
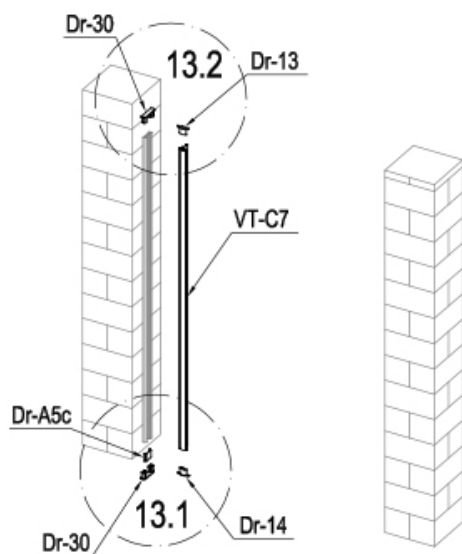

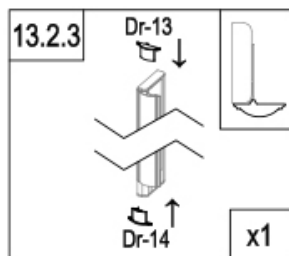

	VT-C7	1
	Dr-13	1
	Dr-14	1
	Dr-30	2
	Dr-A5c	1

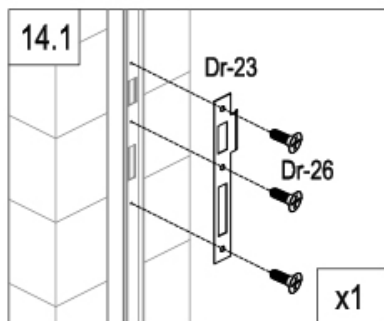
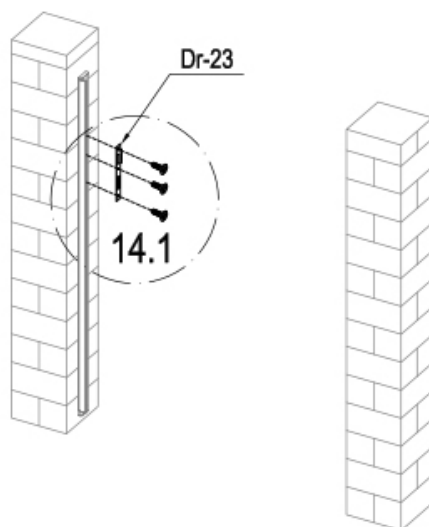



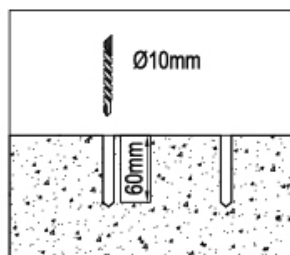
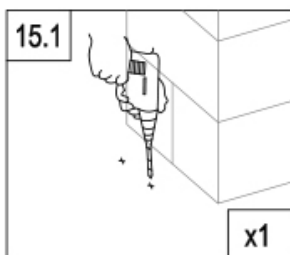
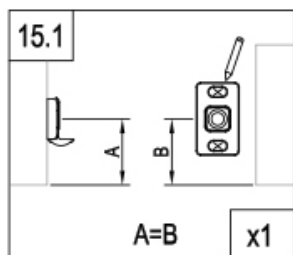
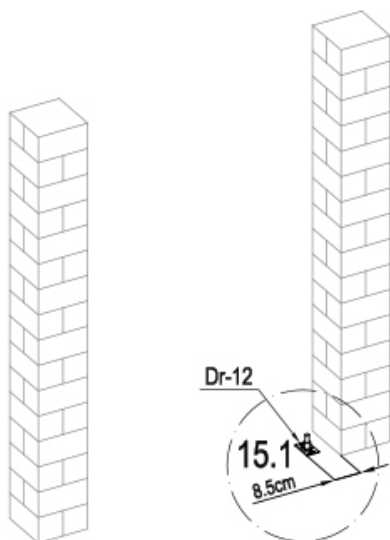

	Dr-23	1
	Dr-26	3

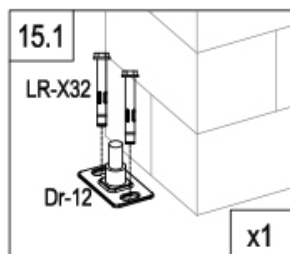

	Dr-12	1
	LR-X32	2

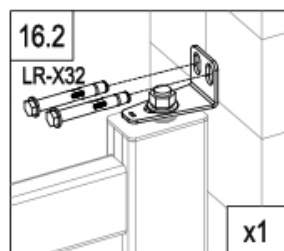
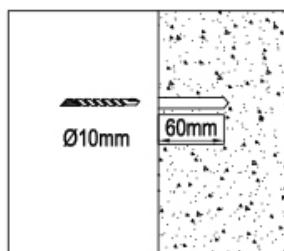
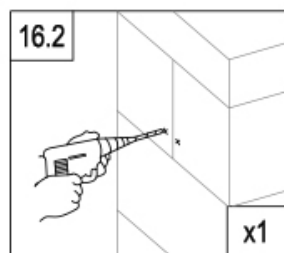
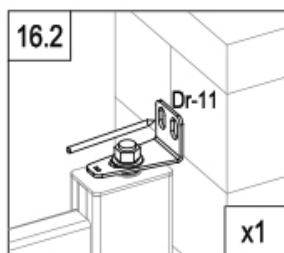
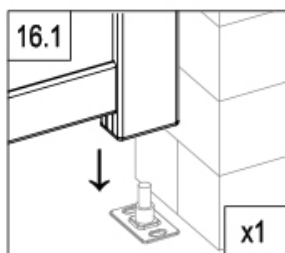
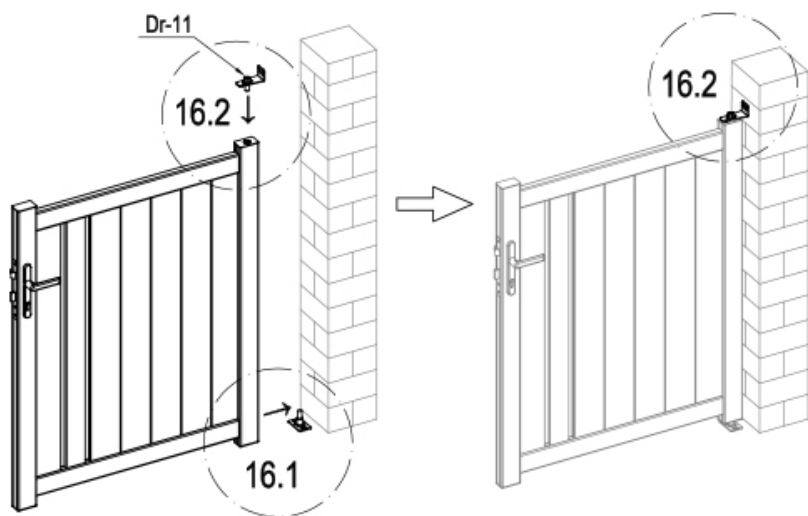





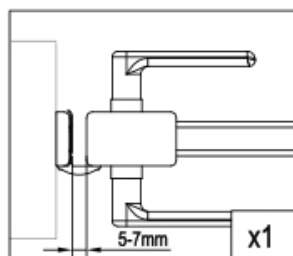
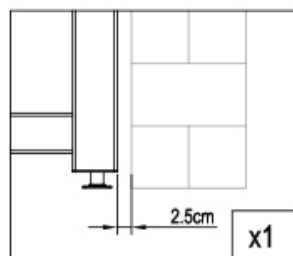
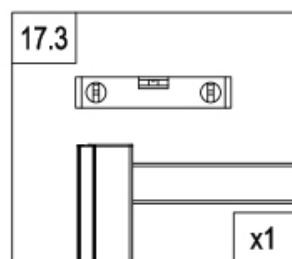
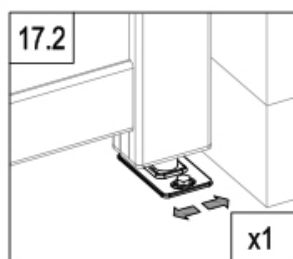
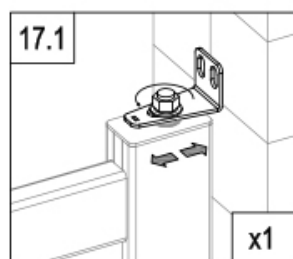
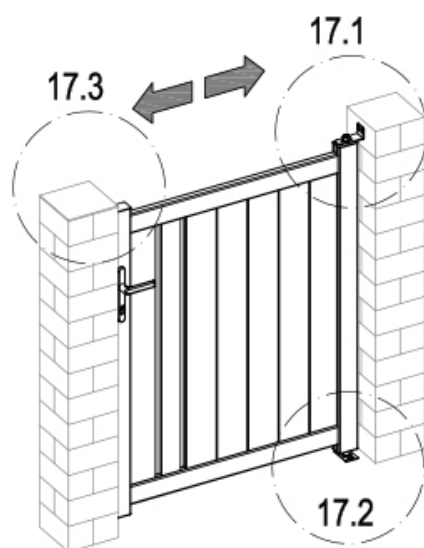

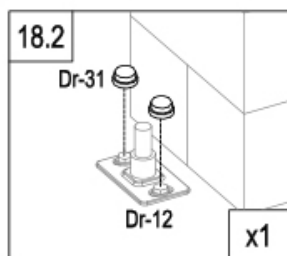
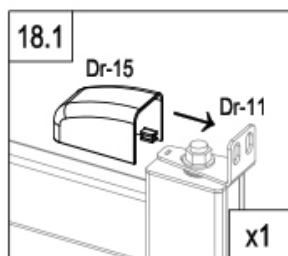
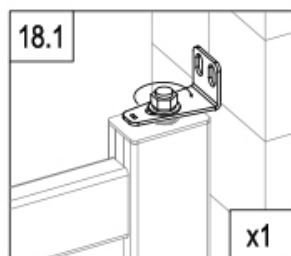
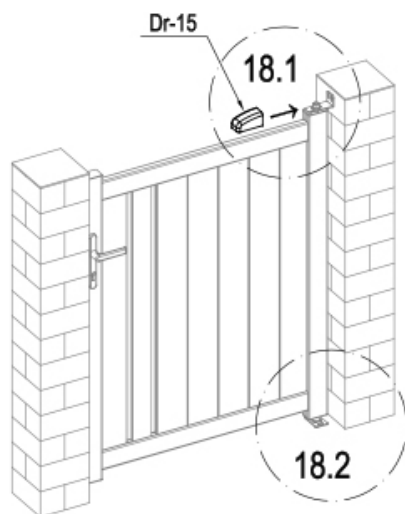
	Dr-11	1
	LR-X32	2



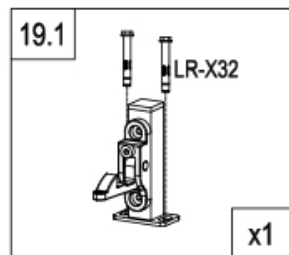
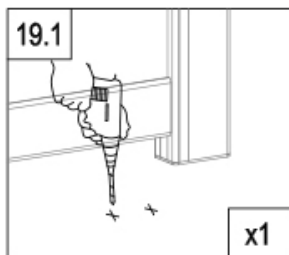
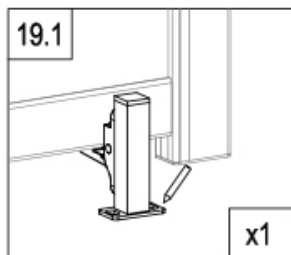
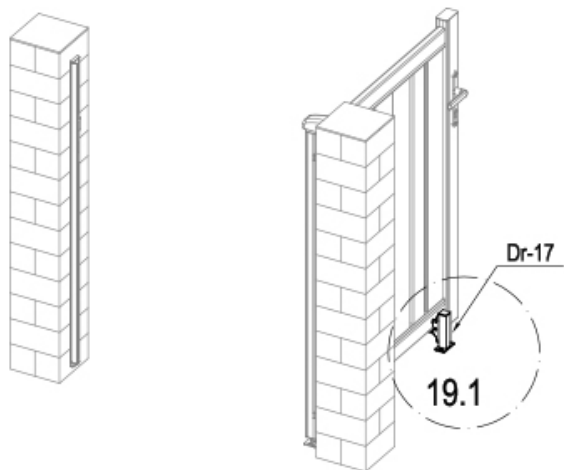

	Dr-15	1
	Dr-31	2



	LR-X32	2
	Dr-17	1

