

CASANOVO

CIMONE 100P160

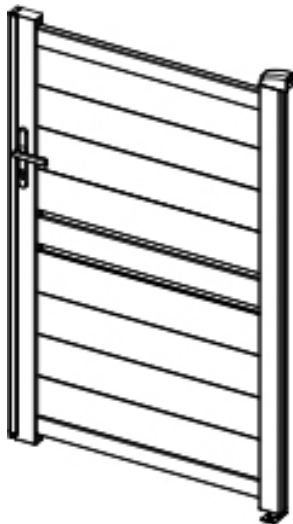

STI-000185 [x1]



3-5H



X 2





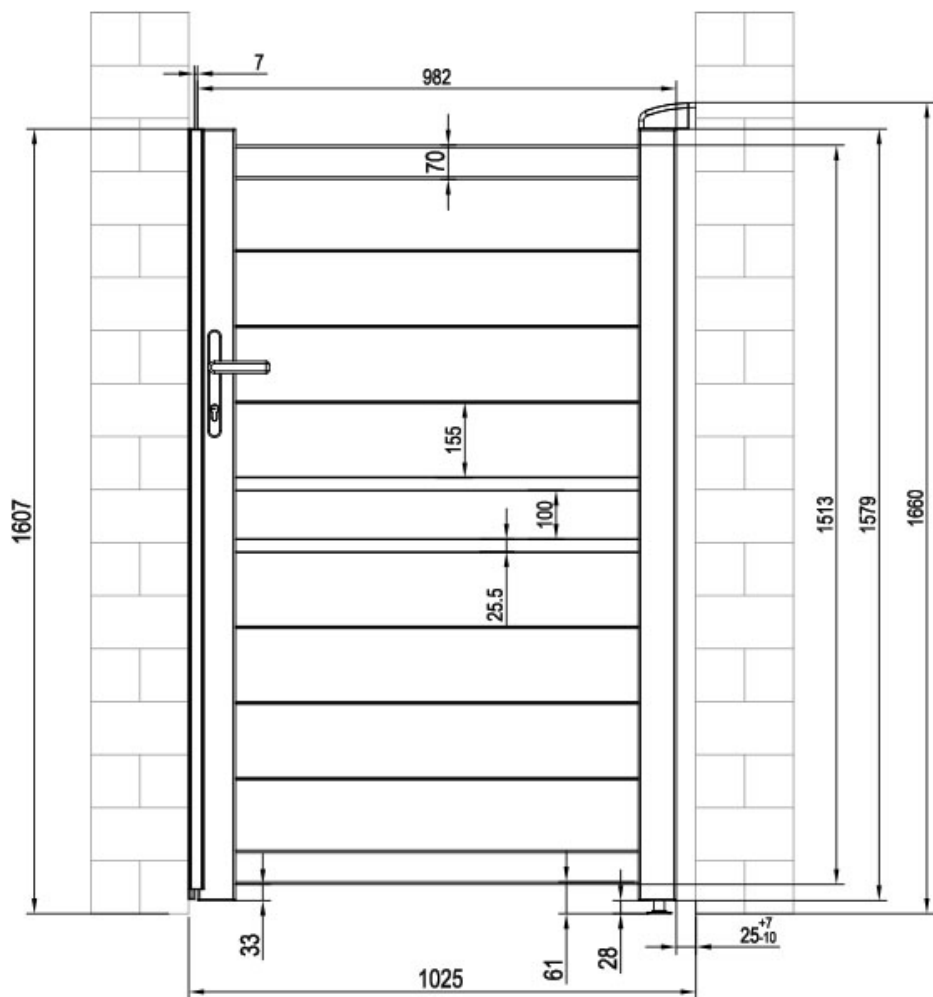

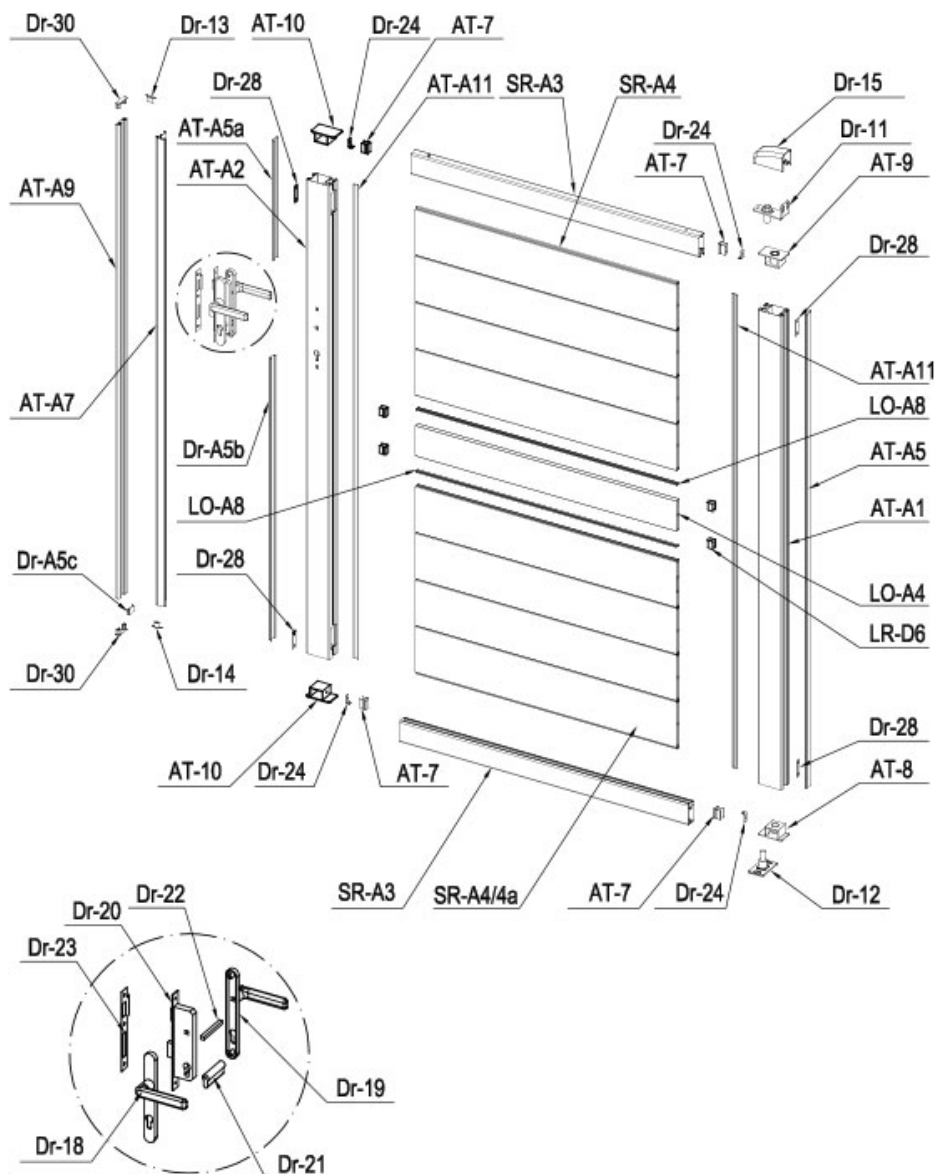



































INSTRUCTION MANUAL / NOTICE DE MONTAGE / MONTAGEANLEITUNG / MANUAL DE MONTAJE / MANUAL DE MONTAGEM / MANUALE DI MONTAGGIO /
MONTAGEHANDLEIDING / INSTRUKCJA MONTAŻU / KÄYTTÖOHJEET / BRUKSANVISNING / BRUGSANVISNING / INSTRUCȚIUNI DE ASAMBLARE /
NAVODILA ZA SESTAVLJANJE / NÁVOD NA MONTÁŽ / ÖSSZESZERELÉSI ÚTMUTATÓ / NÁVOD K MONTÁŽI / UPUTE ZA INSTALACIJU /
ΟΔΗΓΙΕΣ ΣΥΝΑΡΜΟΛΟΓΗΣΗΣ / SURINKIMO INSTRUKCIJOS / MONTĀŽAS INSTRUKCIJAS





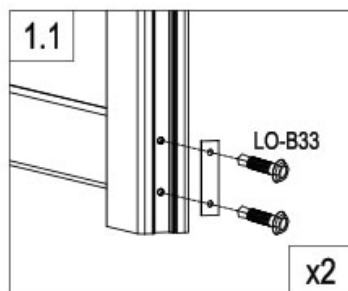
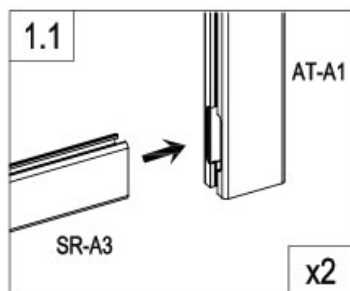
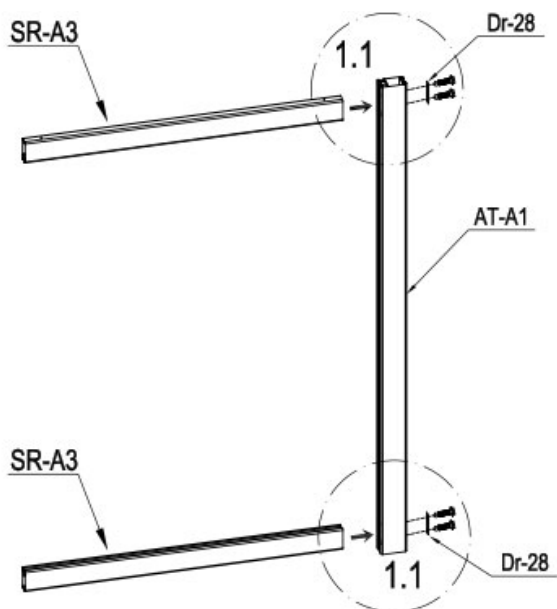

PART LIST

IMAGE	NO.	L.(mm)	QTY	IMAGE	NO.	L.(mm)	QTY
	AT-A1	1573	1		Dr-14		1
	AT-A2	1573	1		Dr-15		1
	SR-A3	959	2		Dr-17		1
	SR-A4a (+SR-A15)	868	1		Dr-30		2
	SR-A4	868	7		Dr-31		2
	LO-A4	868	1		Dr-18		1
	LO-A4	868	1		Dr-19		1
	AT-A5	1573	1		Dr-20		1
	AT-A5a	395.5	1		Dr-21		1
	Dr-A5b	937	1		Dr-22		1
	Dr-A5c	19.5	1		Dr-23		1
	AT-A11	1573	2		Dr-25		1
	AT-7	29.5	4		Dr-25a		2
	LR-D6	25	4		Dr-26		3
	LO-A8	867	2		Dr-27		2
	AT-A7	1553	1		Dr-24		4
	AT-A9	1573	1		Dr-28		4
	AT-8		1		LO-B30		4
	AT-9		1		LO-B31		4
	AT-10		2		LO-B32		6
	Dr-11		1		LO-B33		8
	Dr-12		1		LO-B34		3
	Dr-13		1		LO-B35		34



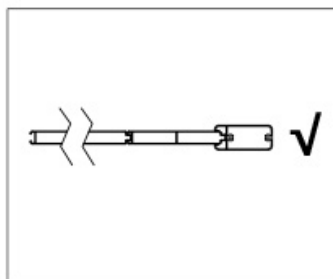
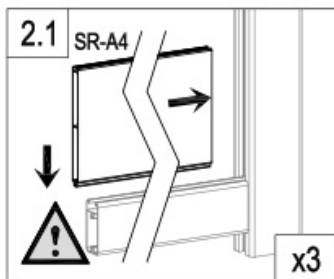
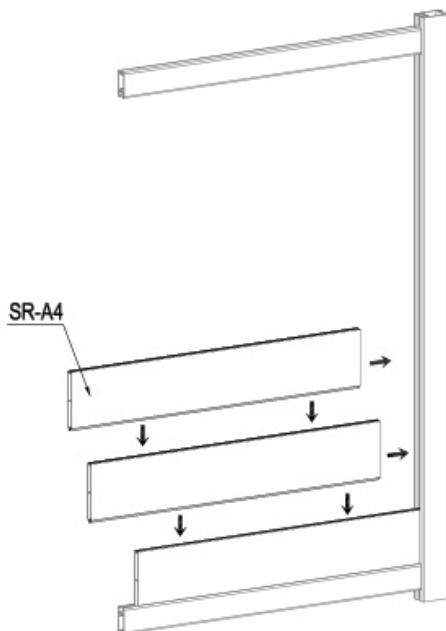

	AT-A1	1
	SR-A3	2
	Dr-28	2
	LO-B33	4



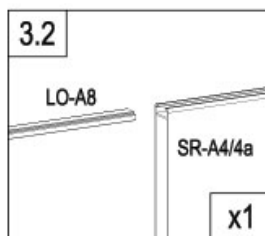
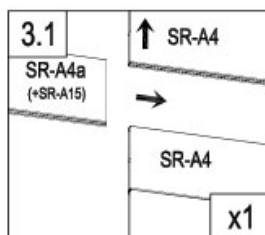
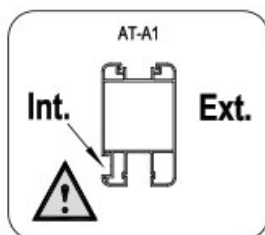
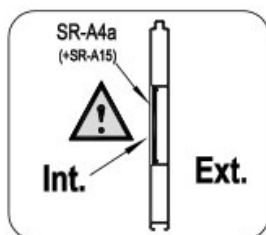
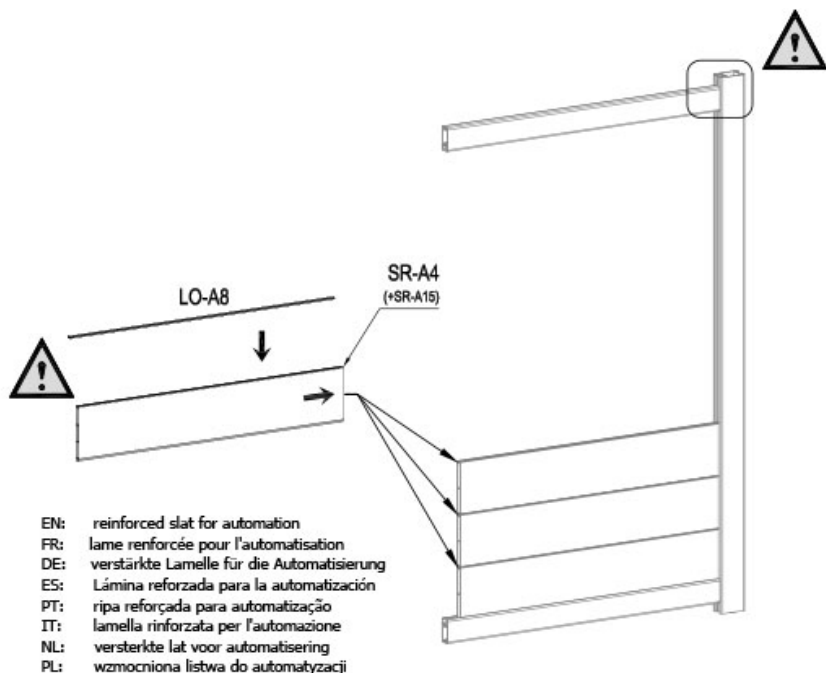

	SR-A4	3
---	-------	---



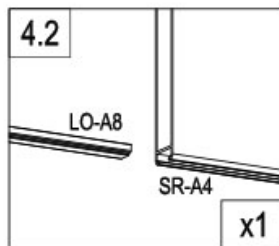
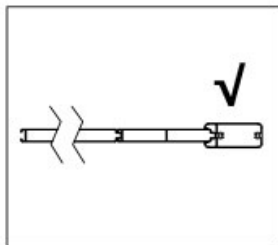
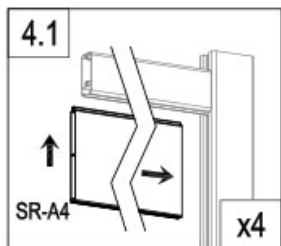
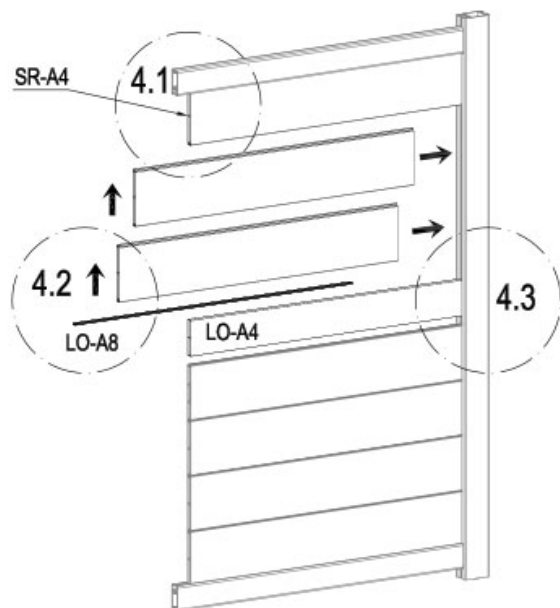



	LO-A8	1
	SR-A4a (+SR-A15)	1

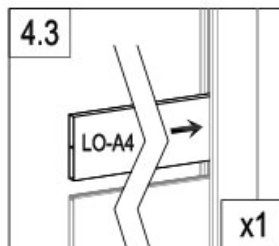

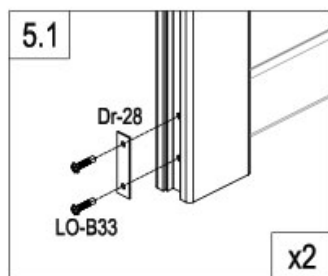
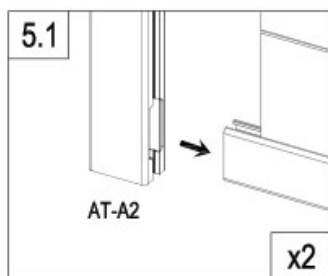
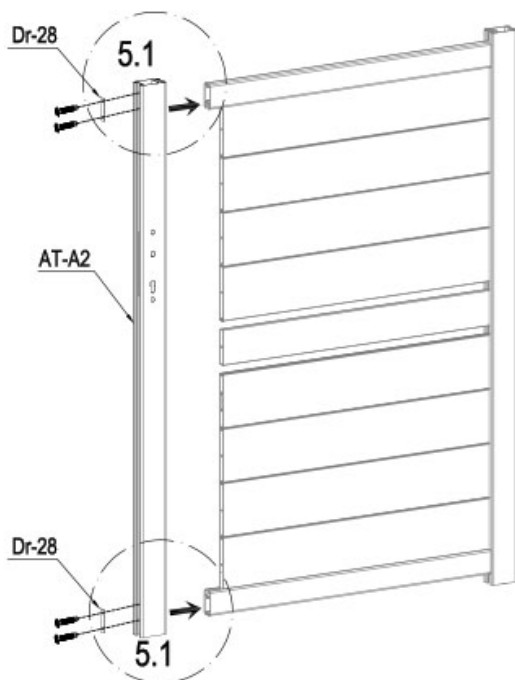
	LO-A4	1
	LO-A8	1
	SR-A4	4





	AT-A2	1
	Dr-28	2
	LO-B33	4

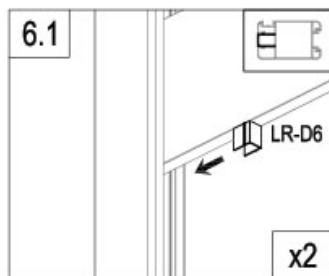
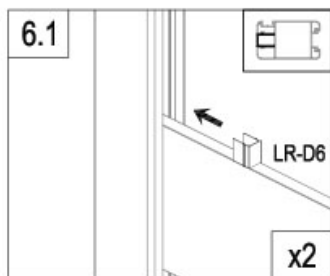
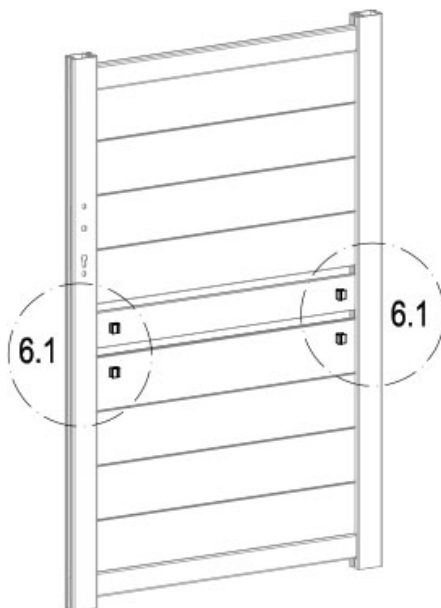

	LR-D6	4
---	-------	---

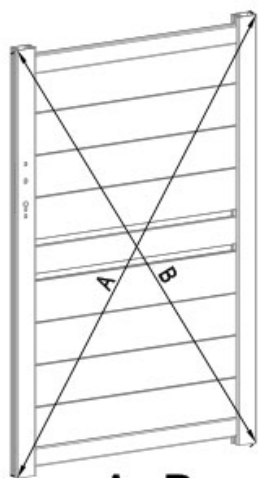

A=B

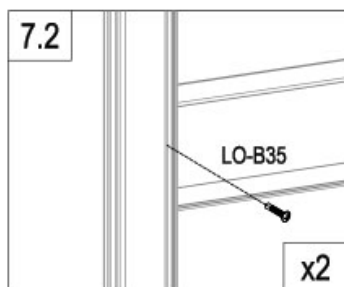
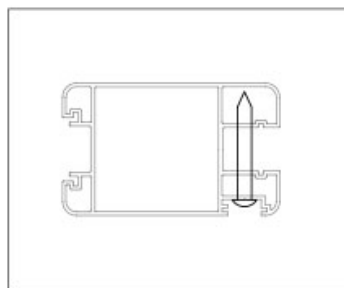
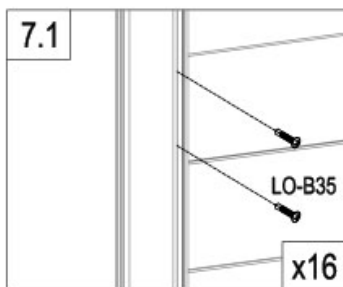
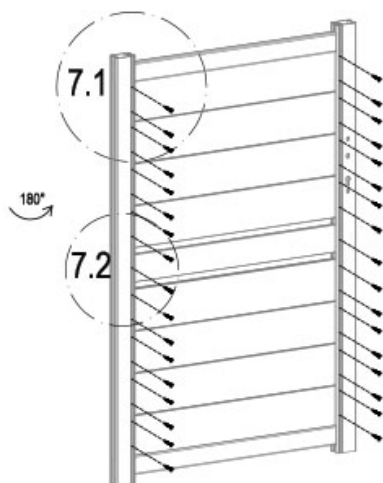

	LO-B35	34
---	--------	----

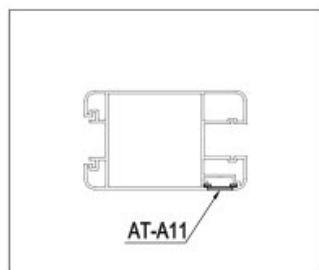
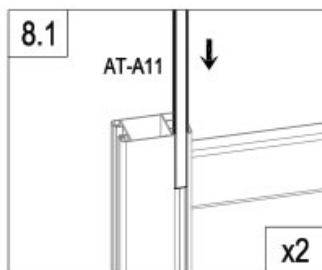
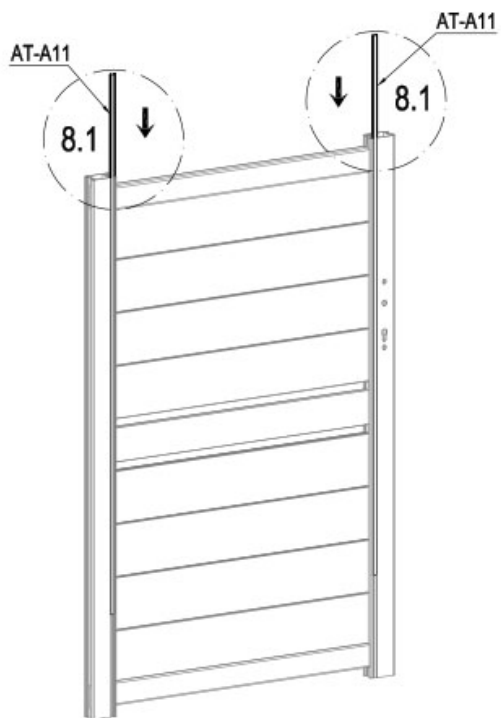

	AT-A11	2
---	--------	---

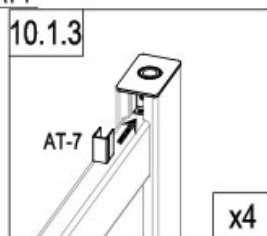
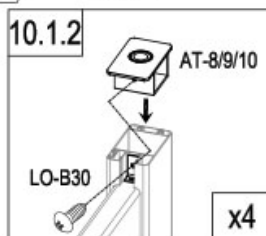
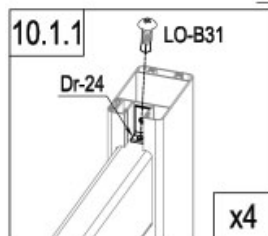
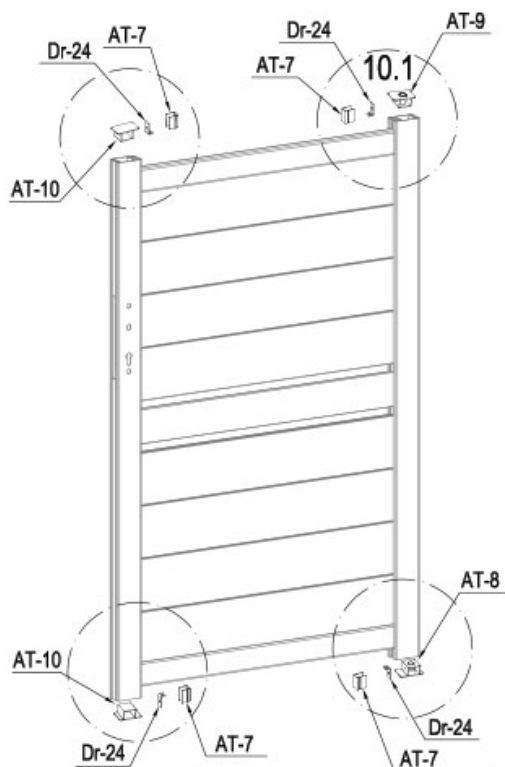

	AT-8	1
	AT-9	1
	AT-10	2
	Dr-24	4

	AT-7	4
	LO-B30	4
	LO-B31	4

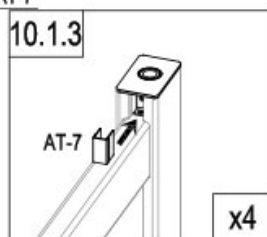
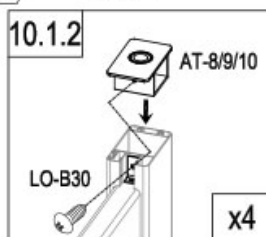
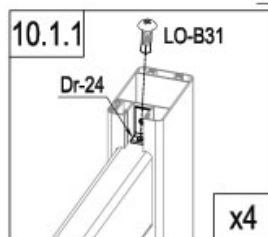
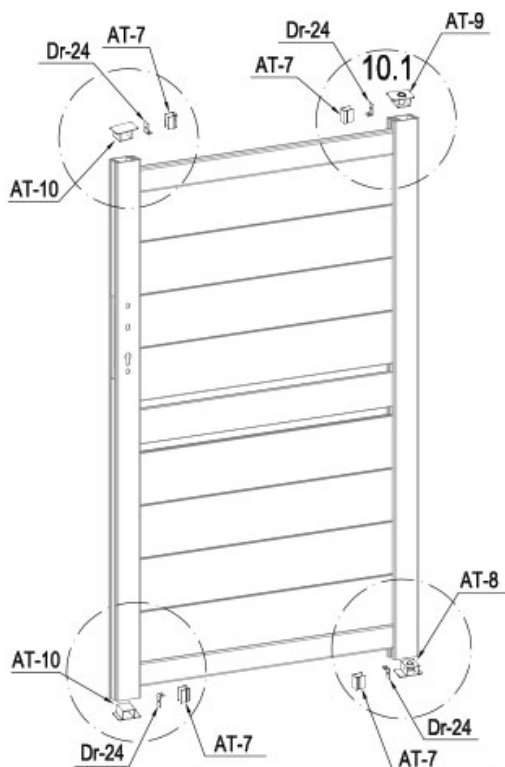

	AT-8	1
	AT-9	1
	AT-10	2
	Dr-24	4

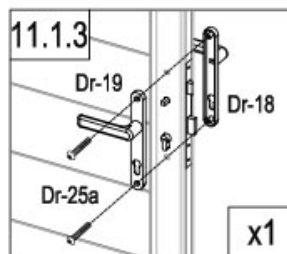
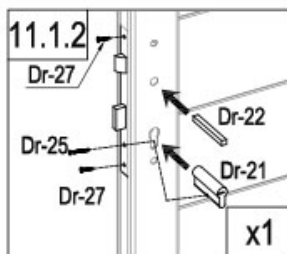
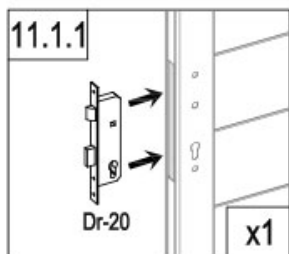
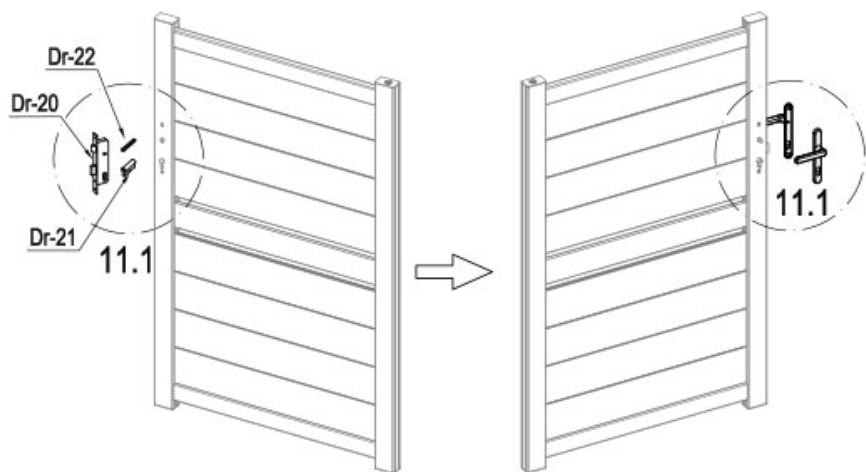

	AT-7	4
	LO-B30	4
	LO-B31	4

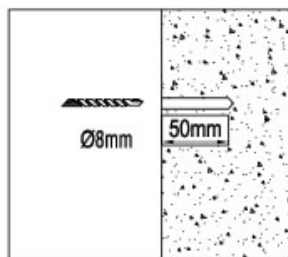
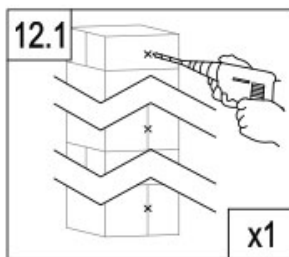
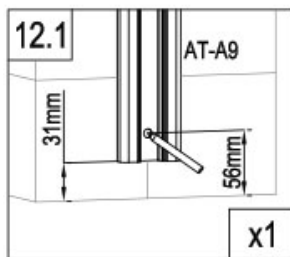
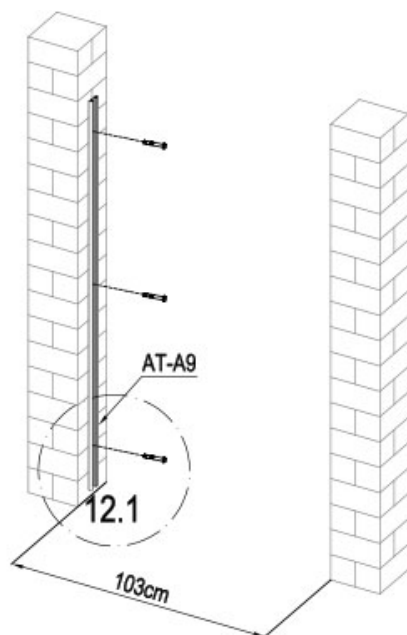

	Dr-20	1
	Dr-21	1
	Dr-22	1
	Dr-25	1

	Dr-18	1
	Dr-19	1
	Dr-25a	2
	Dr-27	2



	AT-A9	1
	LO-B34	3

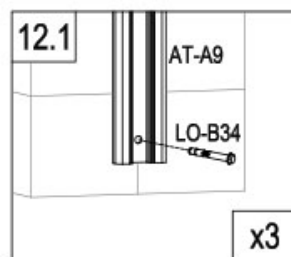

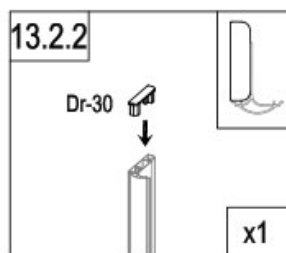
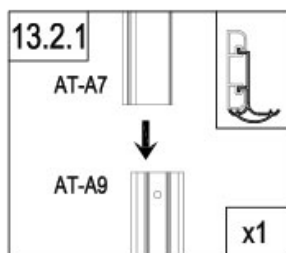
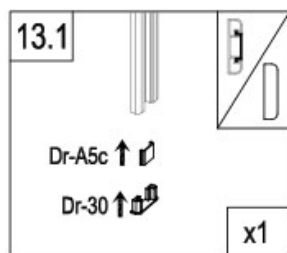
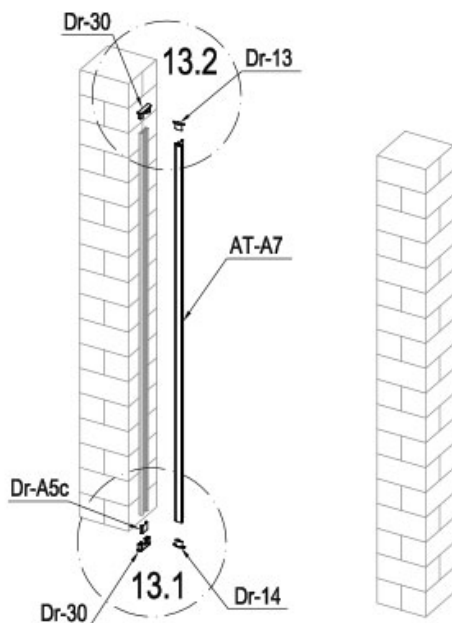

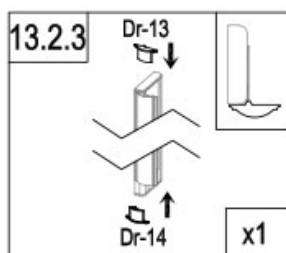

	AT-A7	1
	Dr-13	1
	Dr-14	1
	Dr-30	2
	Dr-A5c	1

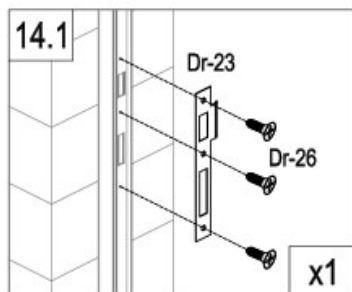
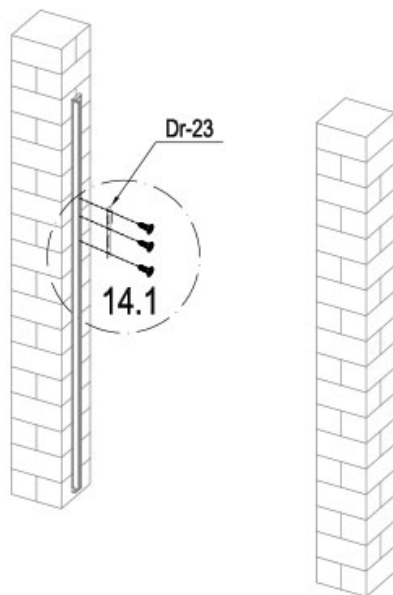



	Dr-23	1
	Dr-26	3

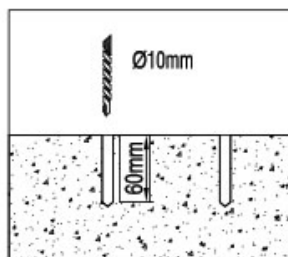
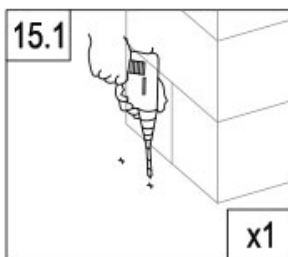
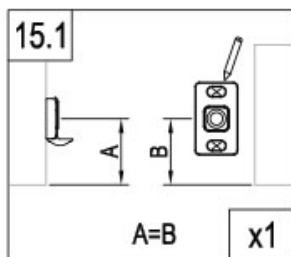
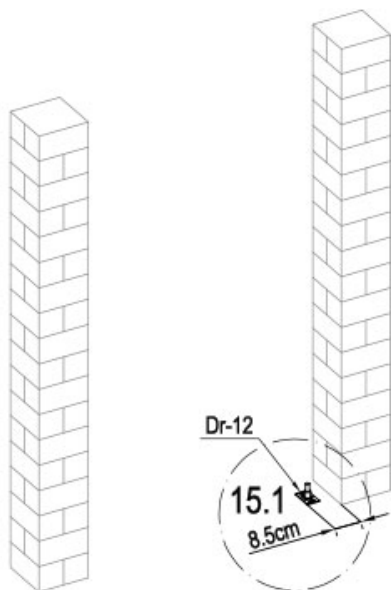

	Dr-12	1
	LO-B32	2

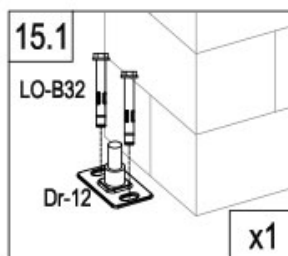

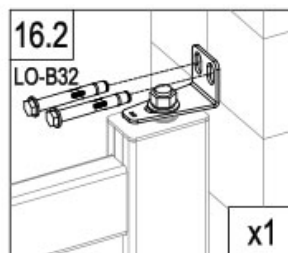
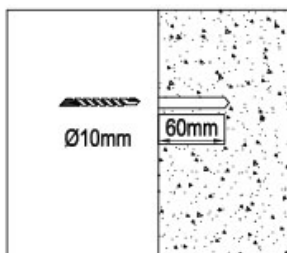
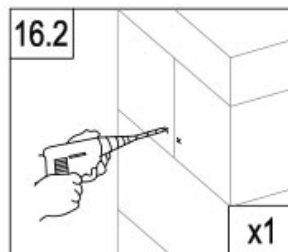
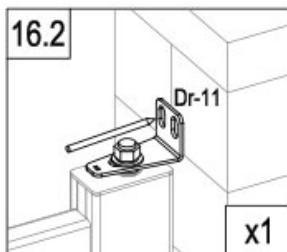
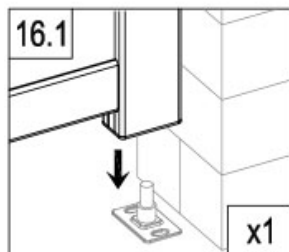
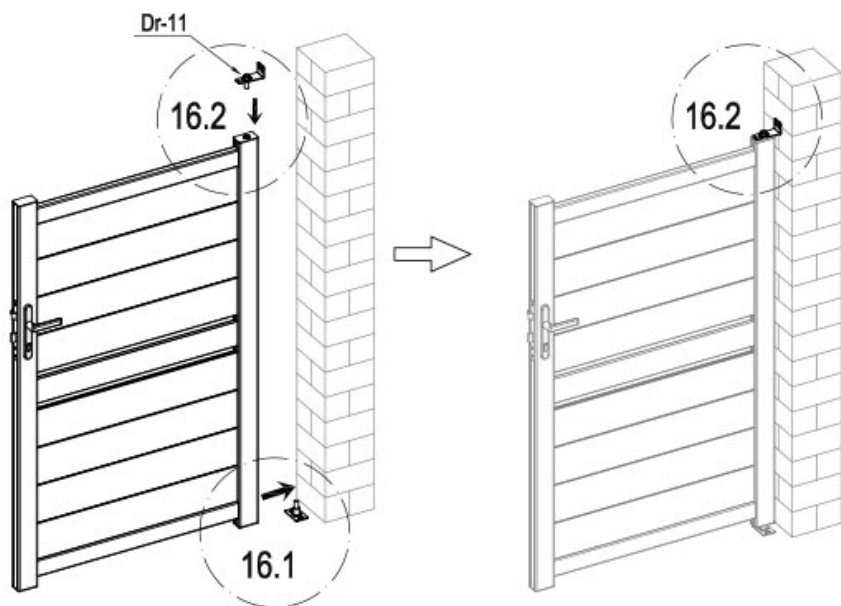



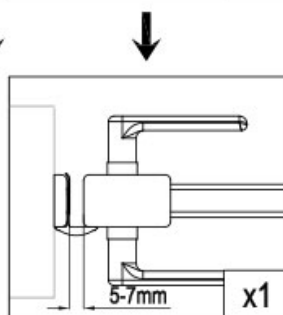
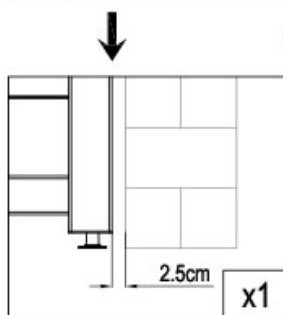
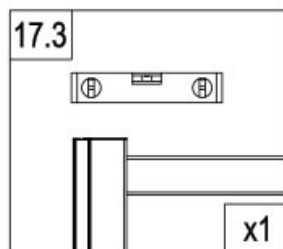
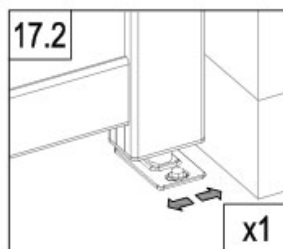
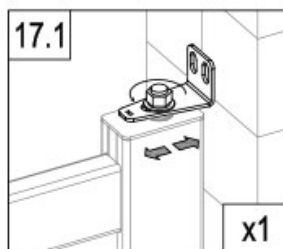
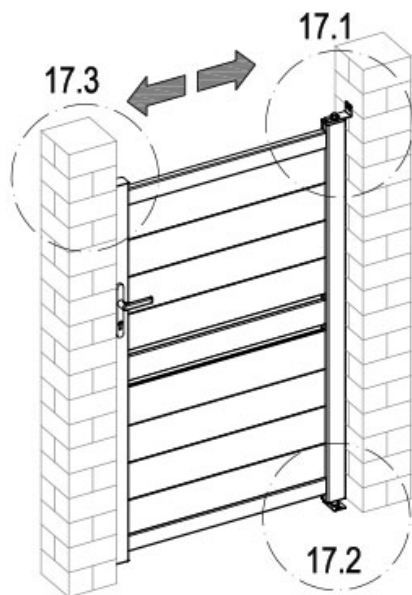

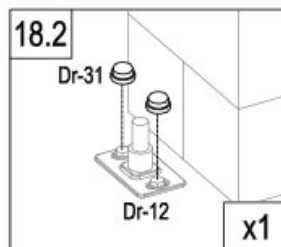
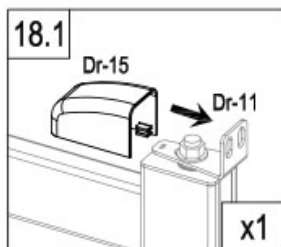
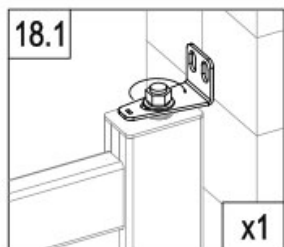
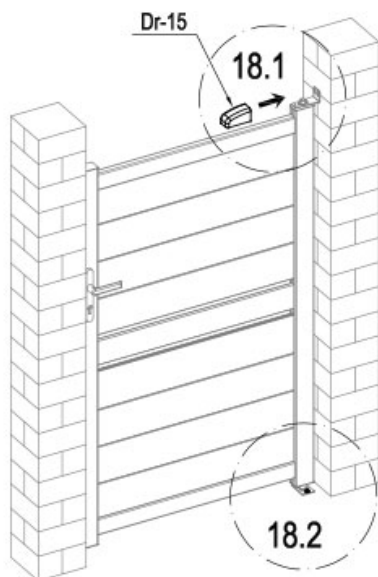
	Dr-11	1
	LO-B32	2



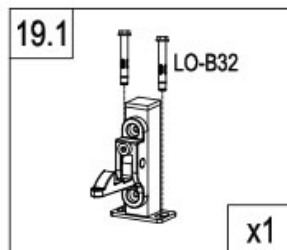
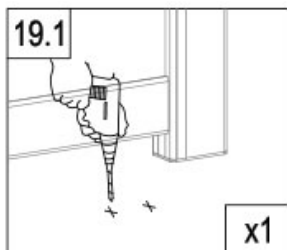
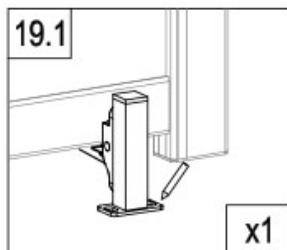
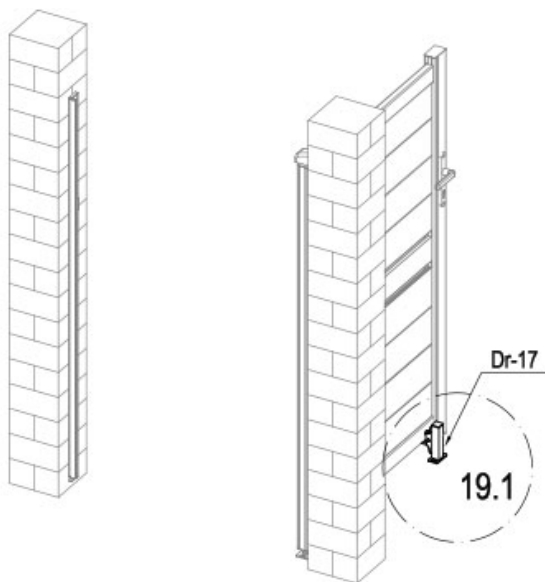

	Dr-15	1
	Dr-31	2



	LO-B32	2
	Dr-17	1