

# CASANOVO

## CIMONE 100P140

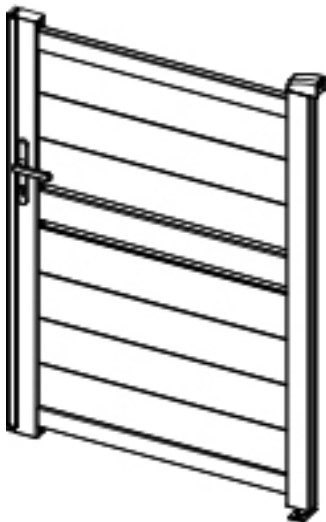

STI-000184 [x1]



3-5H



X 2





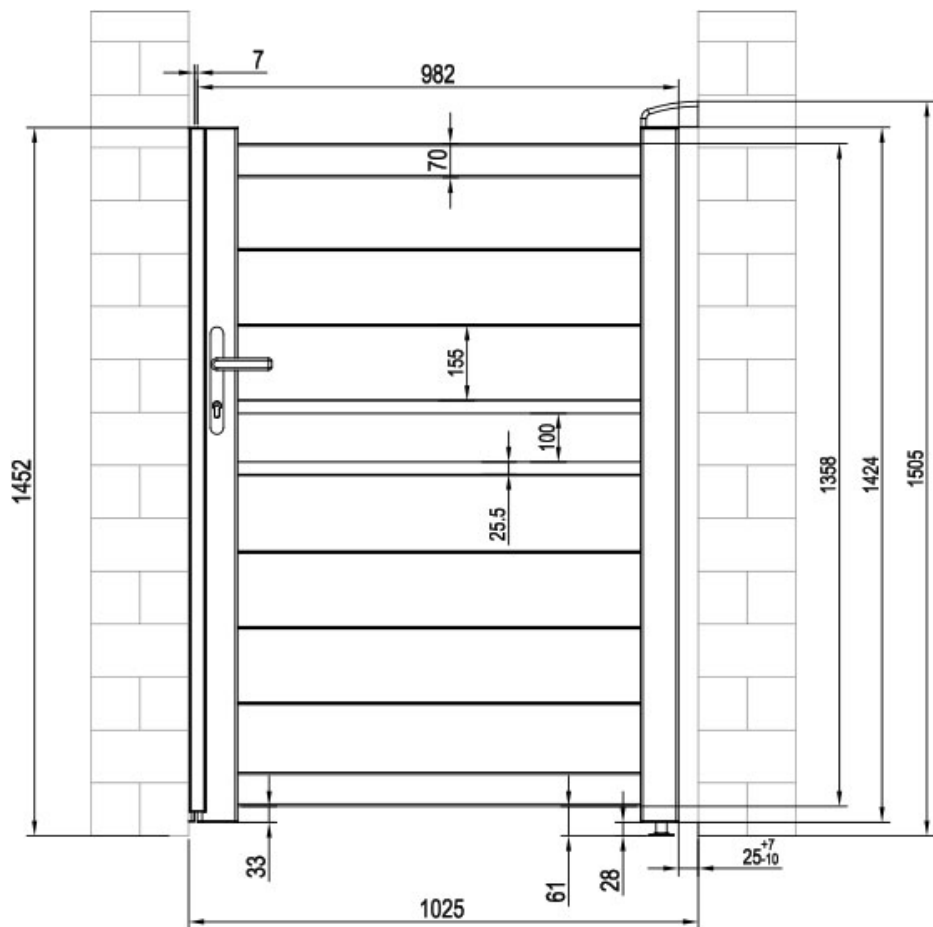

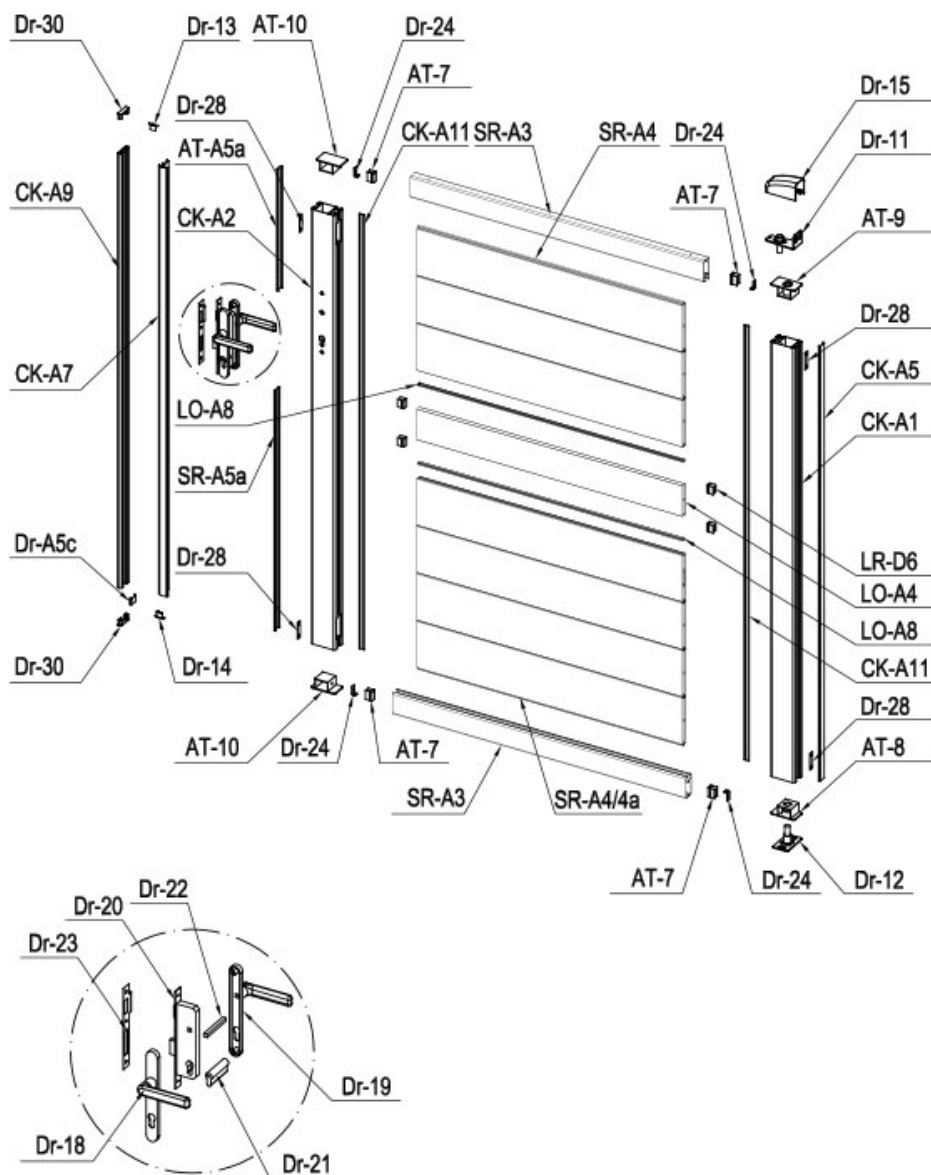



































INSTRUCTION MANUAL / NOTICE DE MONTAGE / MONTAGEANLEITUNG / MANUAL DE MONTAJE / MANUAL DE MONTAGEM / MANUALE DI MONTAGGIO /  
MONTAGEHANDLEIDING / INSTRUKCJA MONTAŻU / KÄYTTÖOHJEET / BRUKSANVISNING / BRUGSANVISNING / INSTRUCȚIUNI DE ASAMBLARE /  
NAVODILA ZA SESTAVLJANJE / NÁVOD NA MONTÁŽ / ÖSSZESZERELÉSI ÚTMUTATÓ / NÁVOD K MONTÁŽI / UPUTE ZA INSTALACIJU /  
ΟΔΗΓΙΕΣ ΣΥΝΑΡΜΟΛΟΓΗΣΗΣ / SURINKIMO INSTRUKCIJOS / MONTAŽAS INSTRUKCIJAS







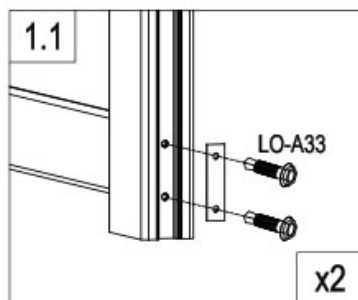
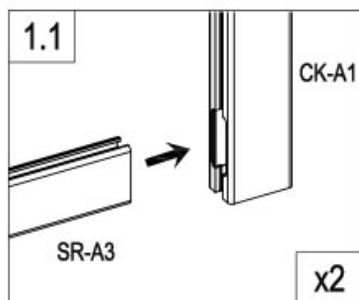
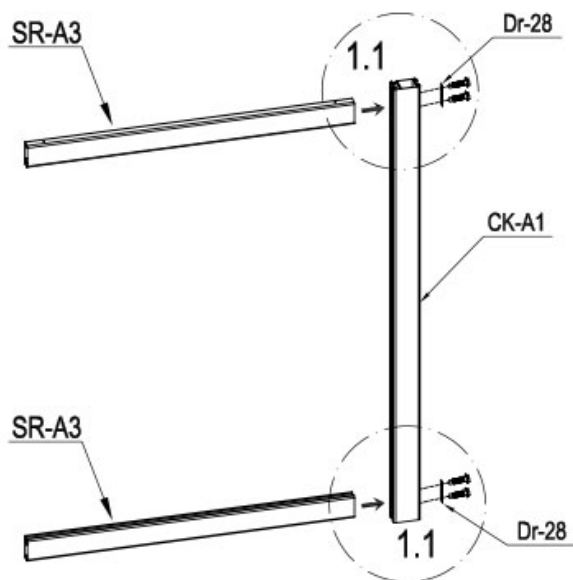

## PART LIST

IMAGE	NO.	L.(mm)	QTY	IMAGE	NO.	L.(mm)	QTY
	CK-A1	1418	1		Dr-14		1
	CK-A2	1418	1		Dr-15		1
	SR-A3	959	2		Dr-17		1
	SR-A4a (+SR-A15)	868	1		Dr-30		2
	SR-A4	868	6		Dr-31		2
	LO-A4	868	1		Dr-18		1
	CK-A5	1418	1		Dr-19		1
	AT-A5a	395.5	1		Dr-20		1
	SR-A5a	782	1		Dr-21		1
	Dr-A5c	19.5	1		Dr-22		1
	CK-A11	1418	2		Dr-23		1
	AT-7	29.5	4		Dr-25		1
	LR-D6	25	4		Dr-25a		2
	LO-A8	867	2		Dr-26		3
	CK-A7	1398	1		Dr-27		2
	CK-A9	1418	1		Dr-24		4
	AT-8		1		Dr-28		4
	AT-9		1		LO-A30		4
	AT-10		2		LO-A31		4
	Dr-11		1		LO-A32		6
	Dr-12		1		LO-A33		8
	Dr-13		1		LO-A34		3
					LO-A35		30



	CK-A1	1
	SR-A3	2
	Dr-28	2
	LO-A33	4

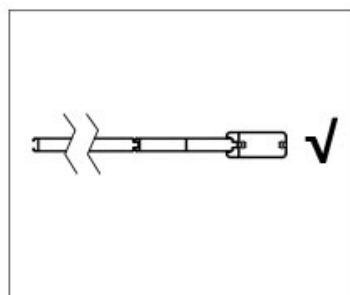
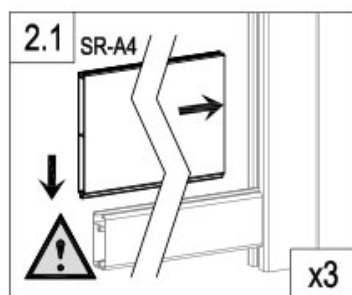
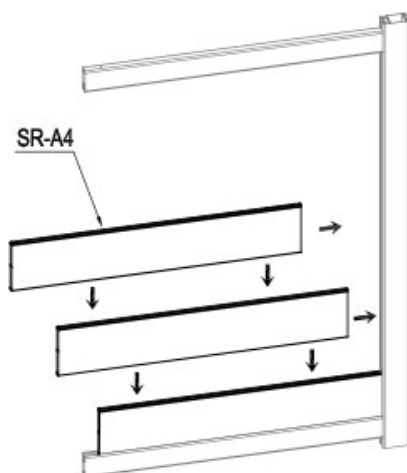

	SR-A4	3
-------------------------------------------------------------------------------------	-------	---

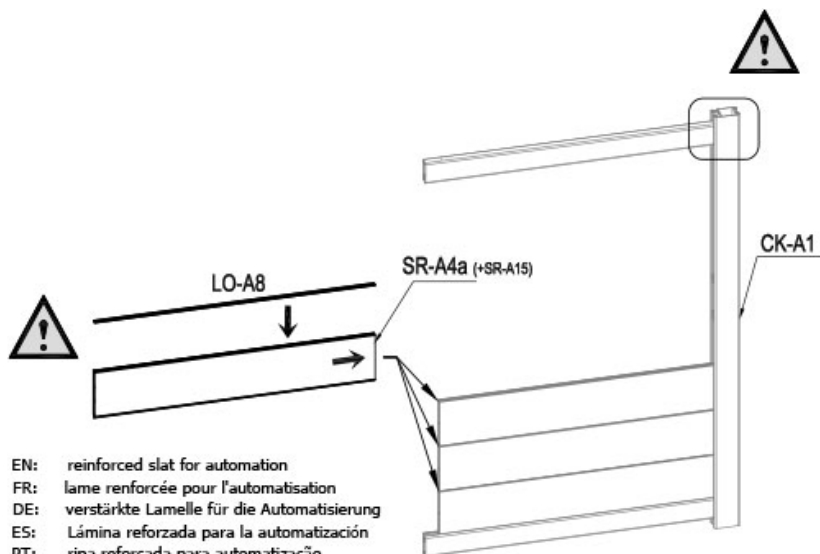

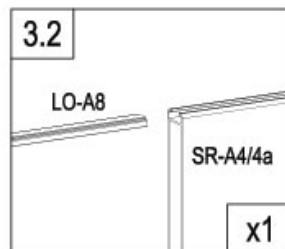
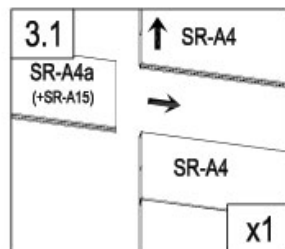
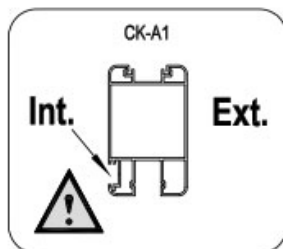
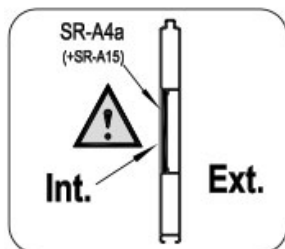

- EN: reinforced slat for automation  
 FR: lame renforcée pour l'automatisation  
 DE: verstärkte Lamelle für die Automatisierung  
 ES: Lámina reforzada para la automatización  
 PT: ripa reforçada para automatização  
 IT: lamella rinforzata per l'automazione  
 NL: versterkte lat voor automatisering  
 PL: wzmocniona listwa do automatyzacji

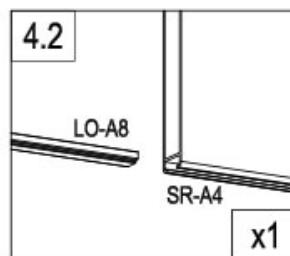
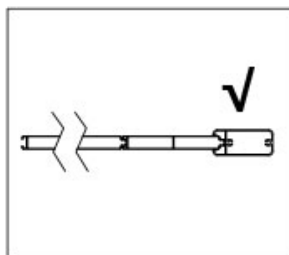
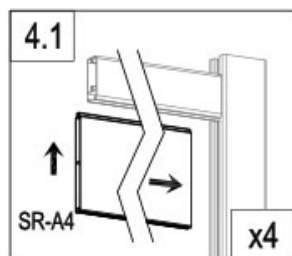
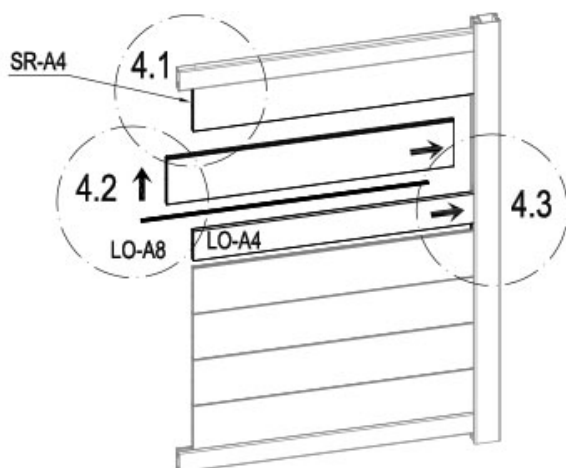

	LO-A8	1
	SR-A4a (+SR-A15)	1



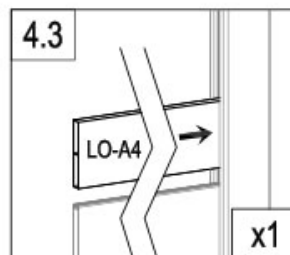

	LO-A4	1
	LO-A8	1
	SR-A4	3



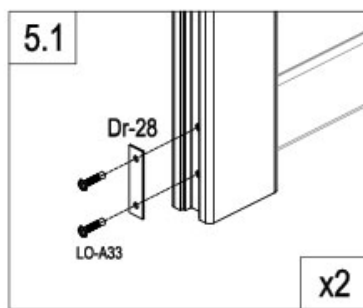
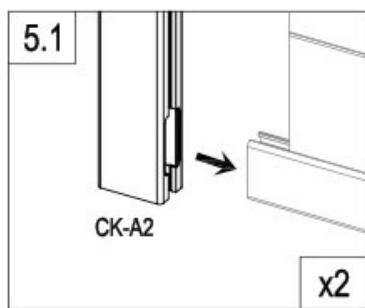
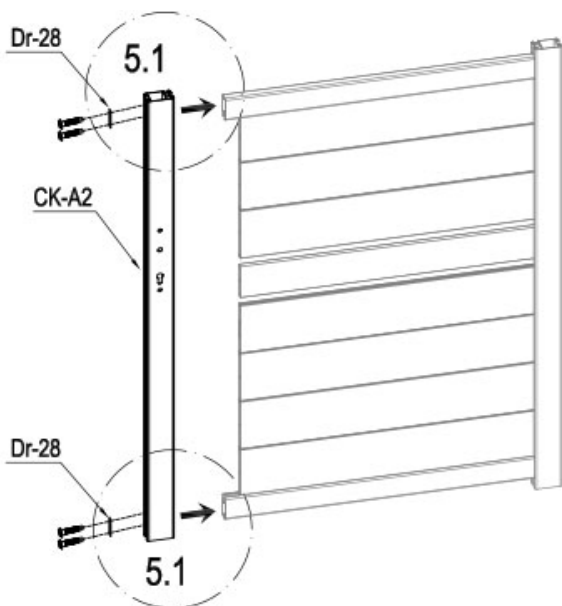



	CK-A2	1
	Dr-28	2
	LO-A33	4

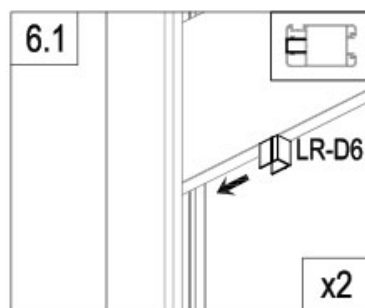
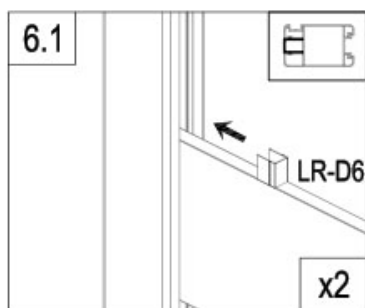
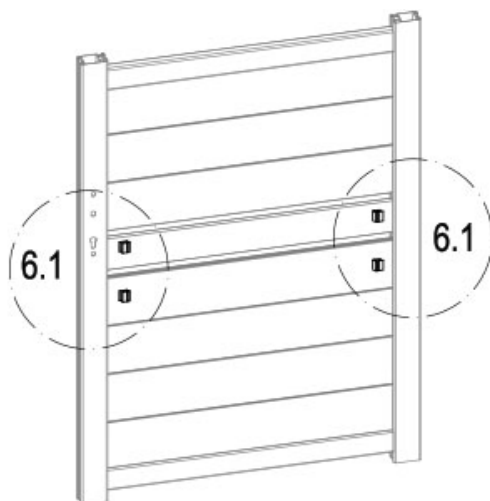

	LR-D6	4
-------------------------------------------------------------------------------------	-------	---

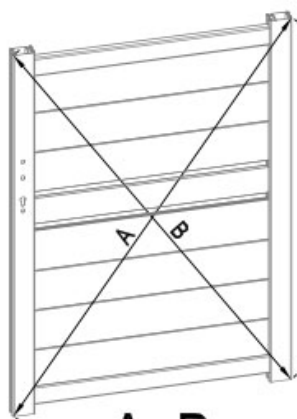

**A=B**

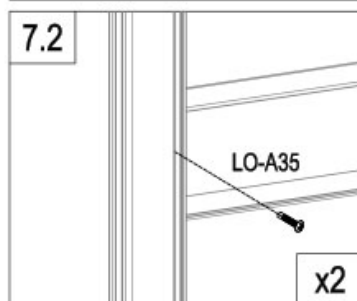
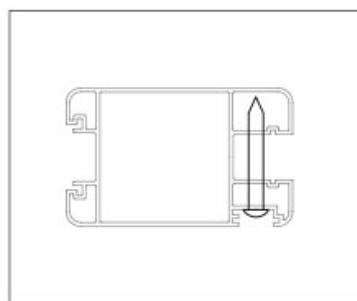
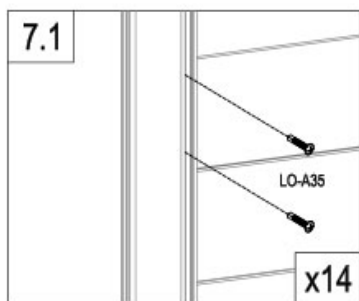
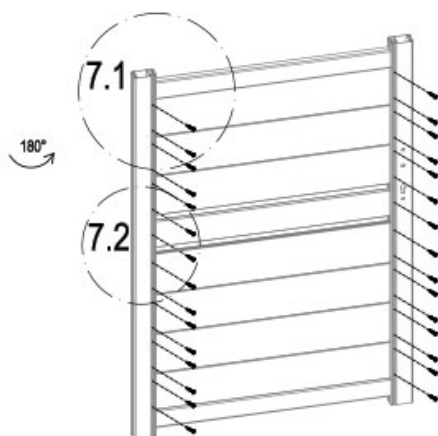

	LO-A35	30
-------------------------------------------------------------------------------------	--------	----

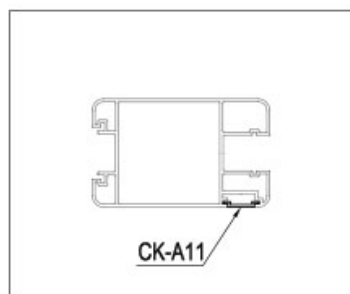
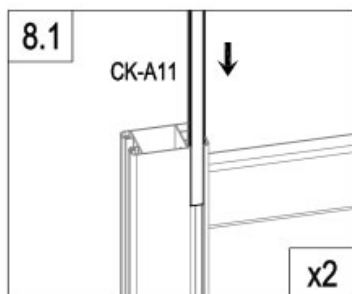
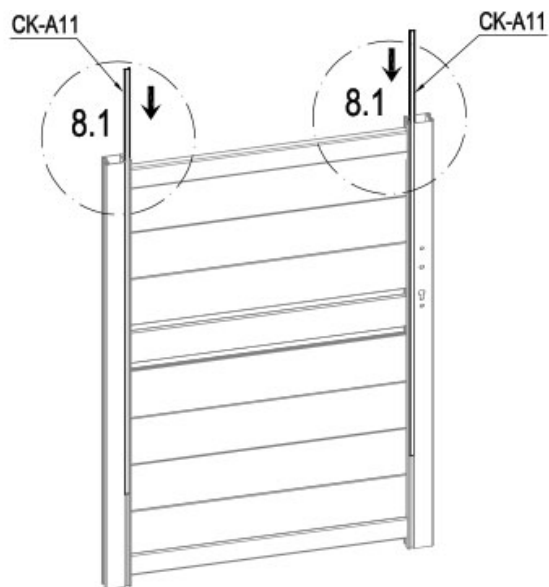

	CK-A11	2
-------------------------------------------------------------------------------------	--------	---

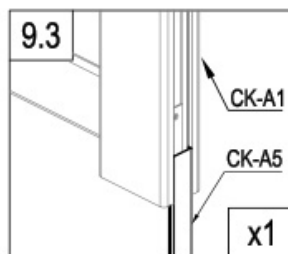
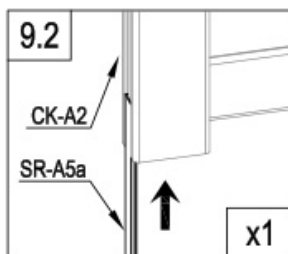
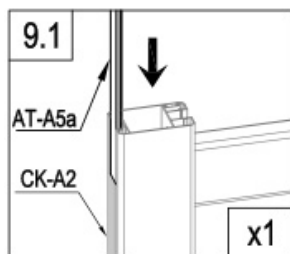
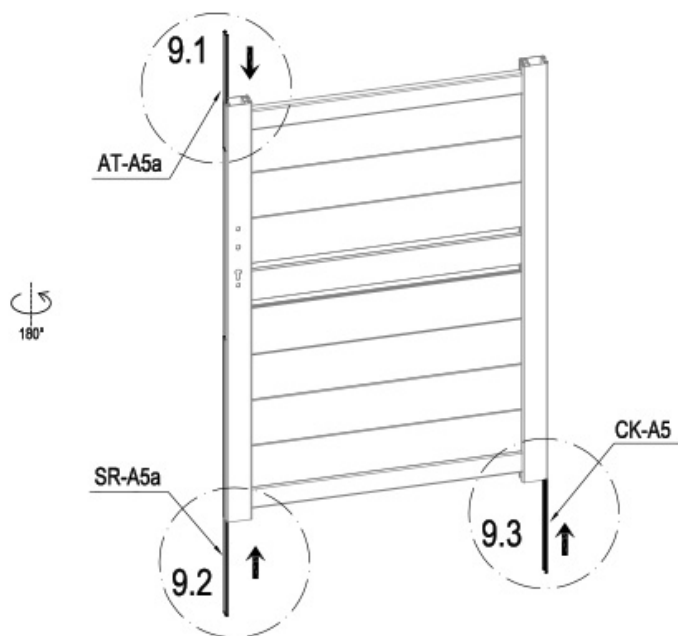

	CK-A5	1
	AT-A5a	1
	SR-A5a	1

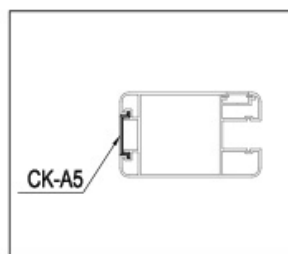

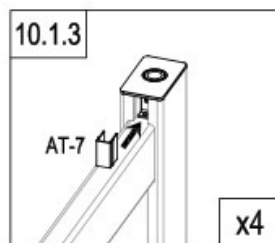
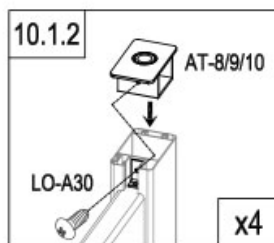
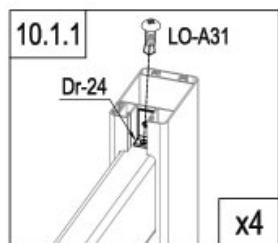
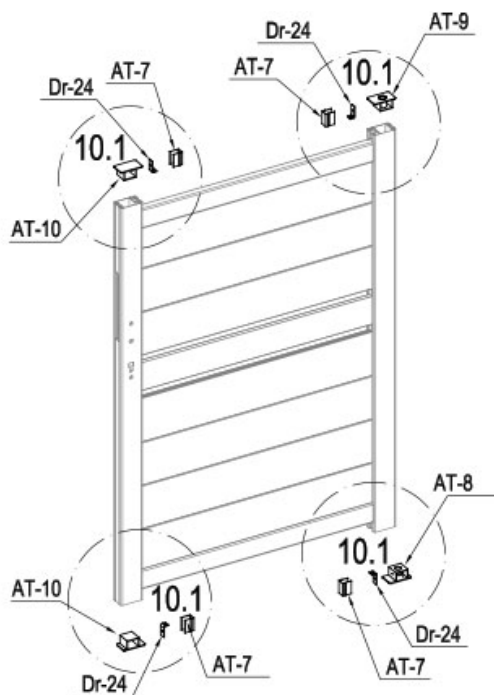

	AT-8	1
	AT-9	1
	AT-10	2
	Dr-24	4

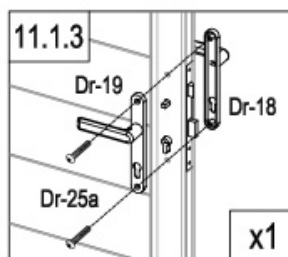
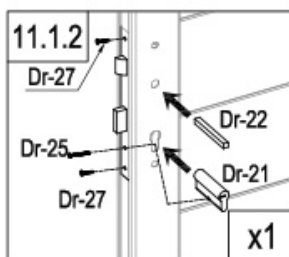
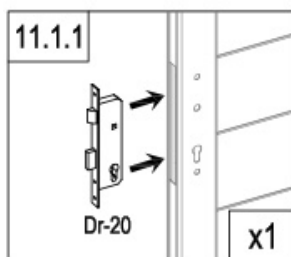
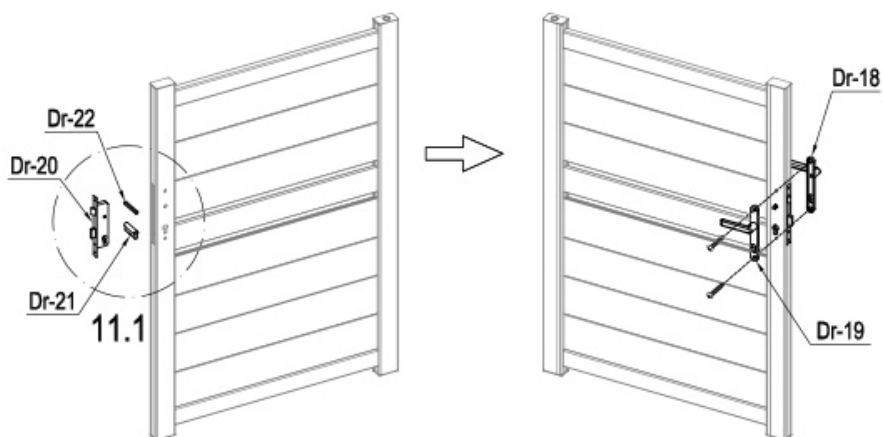

	AT-7	4
	LO-A30	4
	LO-A31	4

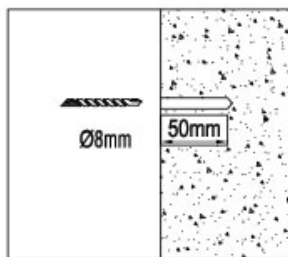
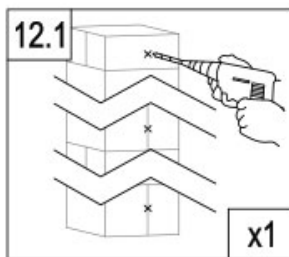
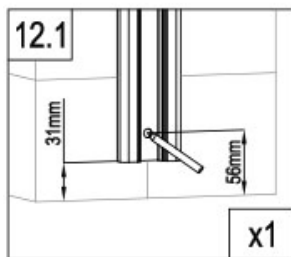
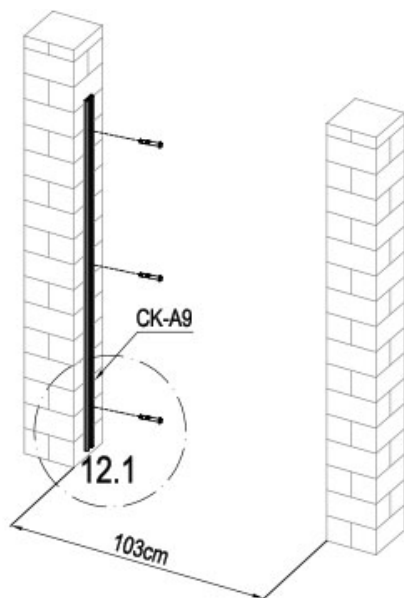

	Dr-20	1
	Dr-21	1
	Dr-22	1
	Dr-25	1

	Dr-18	1
	Dr-19	1
	Dr-25a	2
	Dr-27	2



	CK-A9	1
	LO-A34	3

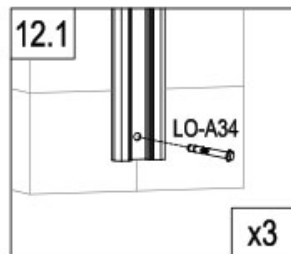



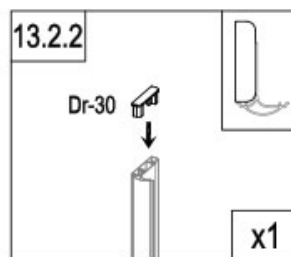
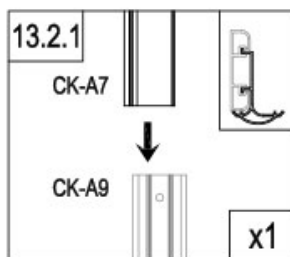
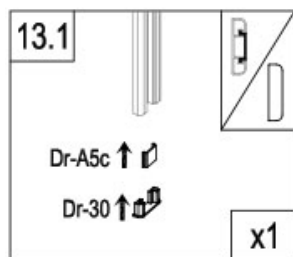
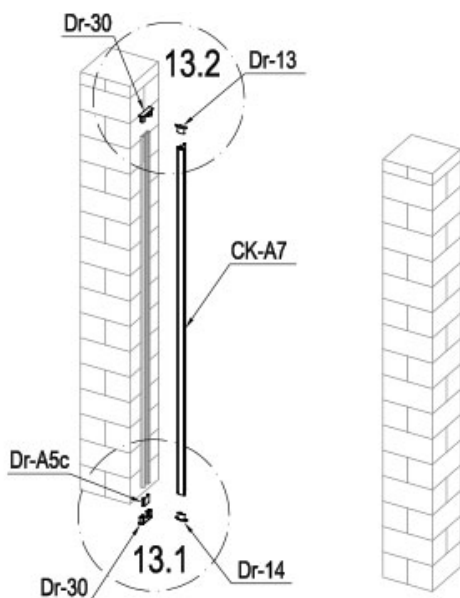

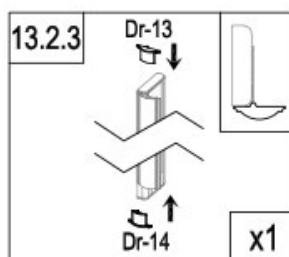

	CK-A7	1
	Dr-13	1
	Dr-14	1
	Dr-30	2
	Dr-A5c	1

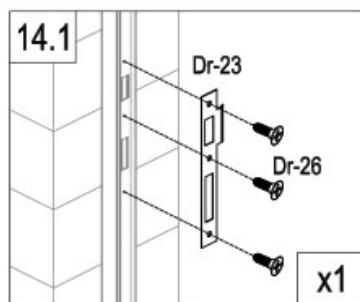
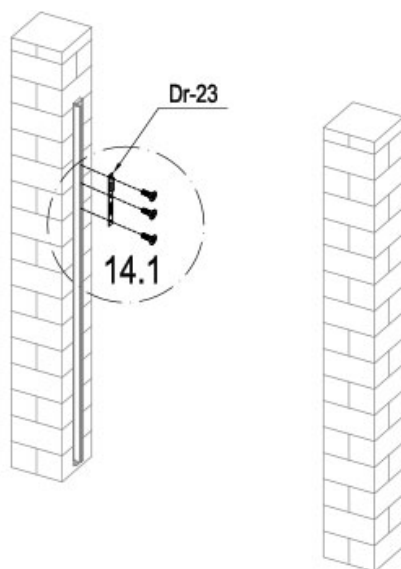



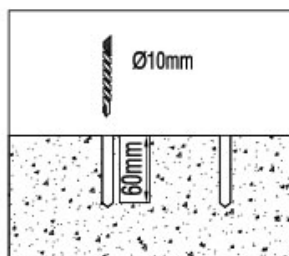
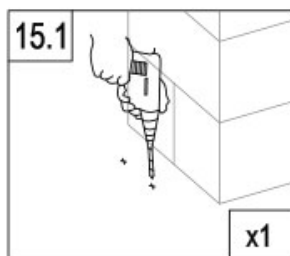
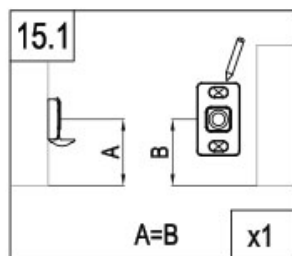
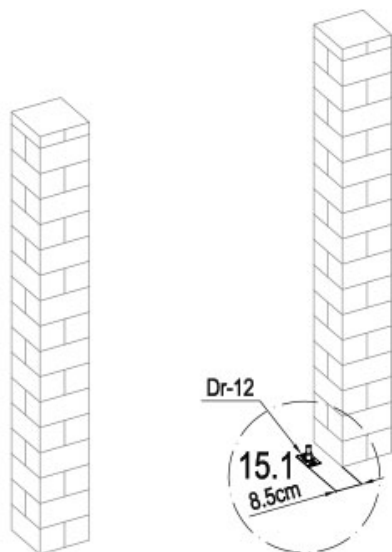

	Dr-23	1
	Dr-26	3

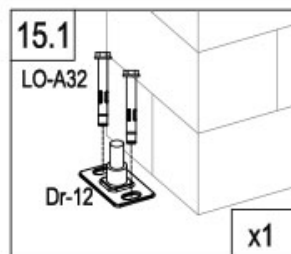

	Dr-12	1
	LO-A32	2

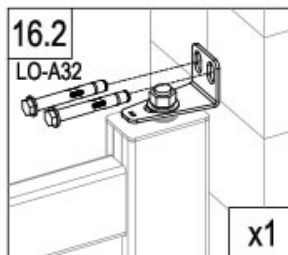
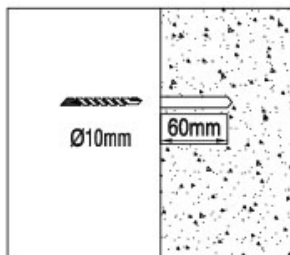
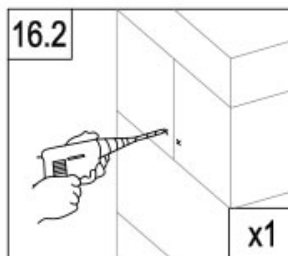
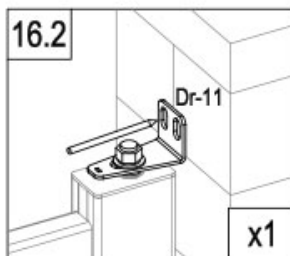
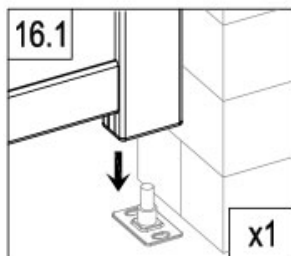
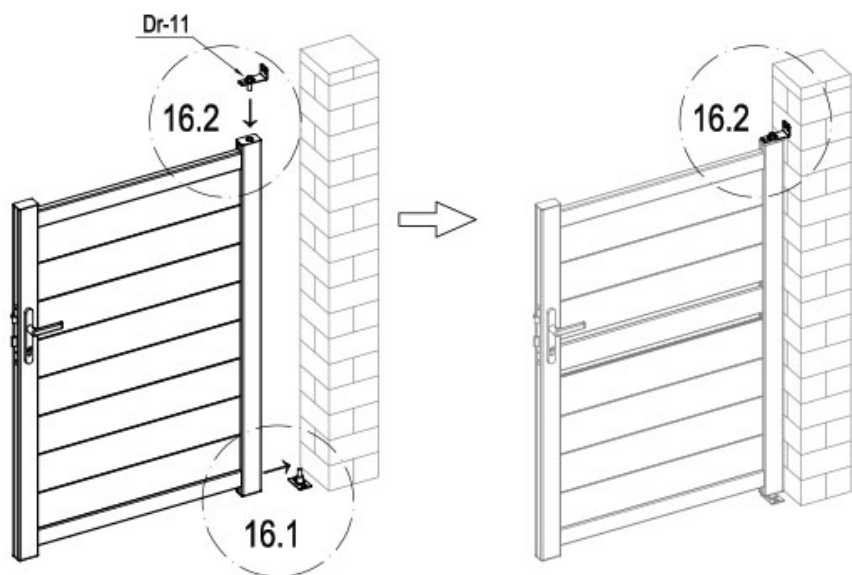





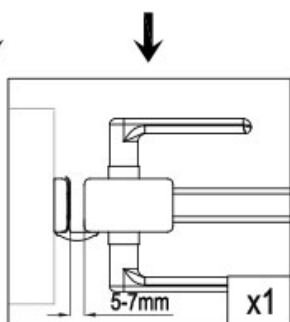
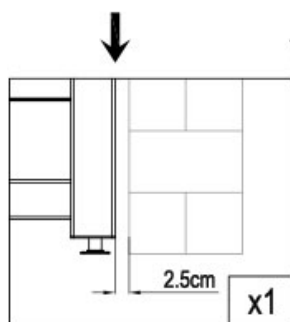
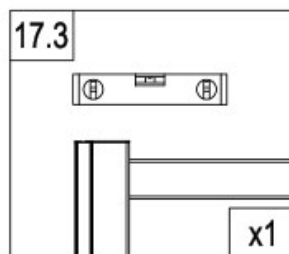
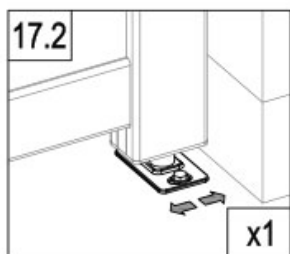
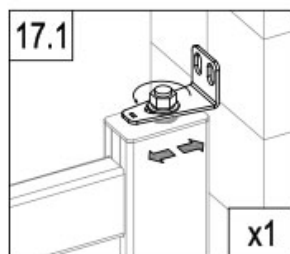
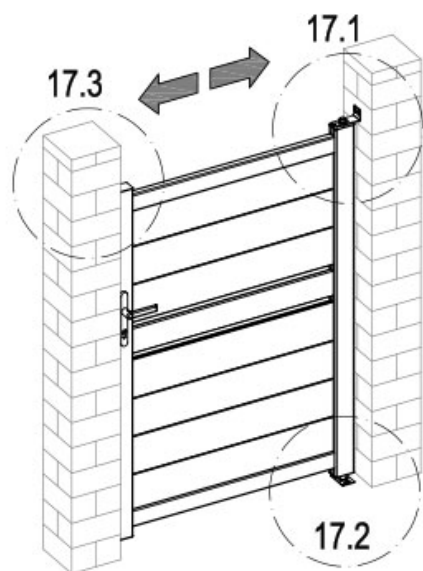

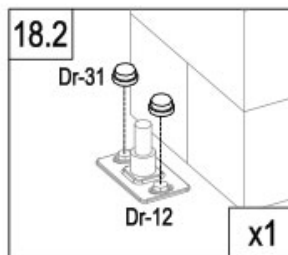
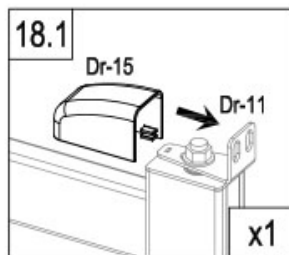
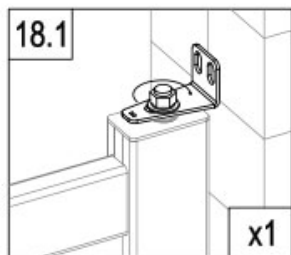
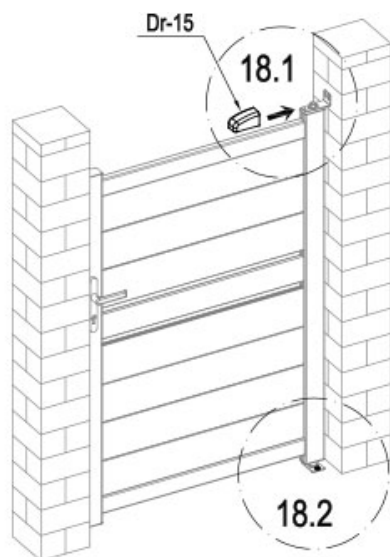
	Dr-11	1
	LO-A32	2



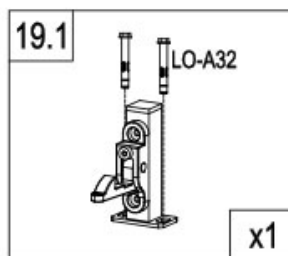
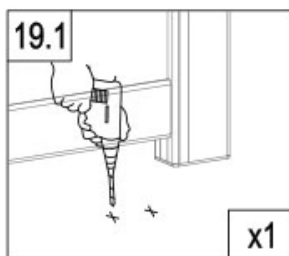
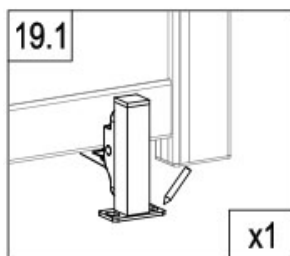
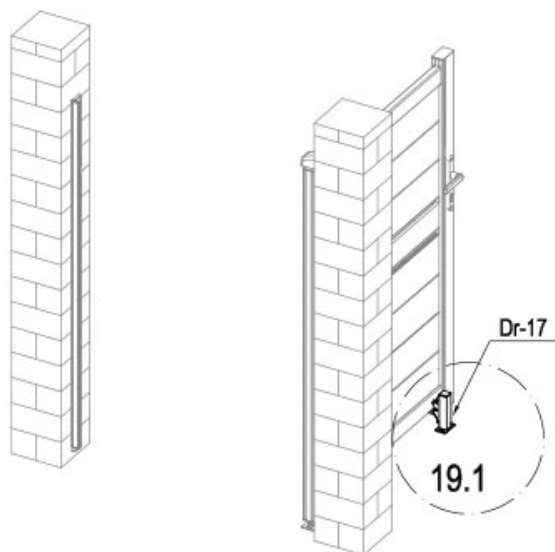

	Dr-15	1
	Dr-31	2



	LO-A32	2
	Dr-17	1