

# CASANOVO

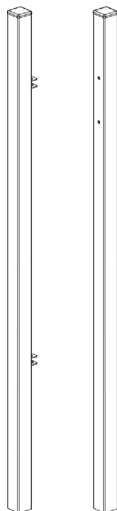









## DARIO 06H170



STI - 000164 [x1]



INSTRUCTION MANUAL / NOTICE DE MONTAGE / MONTAGEANLEITUNG / MANUAL DE MONTAJE / MANUAL DE MONTAGEM / MANUALE DI MONTAGGIO /  
MONTAGEHANDLEIDING / INSTRUKCJA MONTAŻU / KÄYTTÖOHJEET / BRUKSANVISNING / BRUGSANVISNING / INSTRUCȚIUNI DE ASAMBLARE /  
NAVODILA ZA SESTAVLJANJE / NÁVOD NA MONTÁŽ / ÖSSZESZERELÉSI ÚTMUTATÓ / NÁVOD K MONTÁŽI / UPUTE ZA INSTALACIJU /  
ΟΔΗΓΙΕΣ ΣΥΝΑΡΜΟΛΟΓΗΣΗΣ / SURINKIMO INSTRUKCIJOS / MONTĀŽAS INSTRUKCIJAS

|   | REF-PCS | DIM          |    |
|---|---------|--------------|----|
|  | JHA-1   | 60×60×1700mm | 1  |
|  | JHA-2   | 60×60×1700mm | 1  |
|  | JH02    | 23×10mm      | 4  |
|  | JH03    | 30×1mm       | 10 |
|  | JH04    | 16×120mm     | 2  |
|  | JH05    | 15×35mm      | 2  |
|  | JH06    | 22×2mm       | 2  |
|  | JH07    | 7×20mm       | 2  |
|  | JH17    | 6×35mm       | 2  |
|  | JH18    | 30×210mm     | 1  |

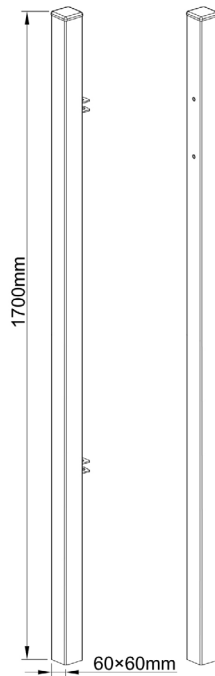

|   |      |          |   |
|---|------|----------|---|
|  | JH17 | 6x35mm   | 2 |
|  | JH18 | 30x210mm | 1 |

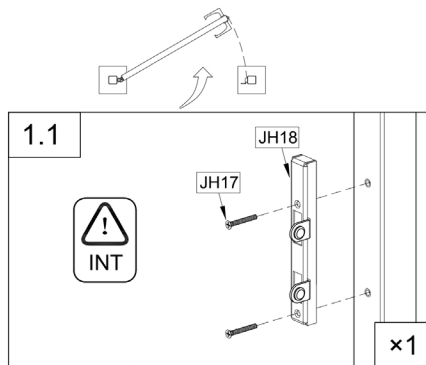
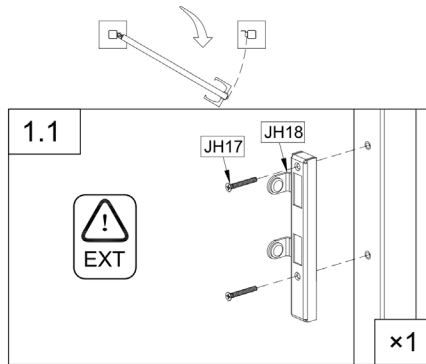
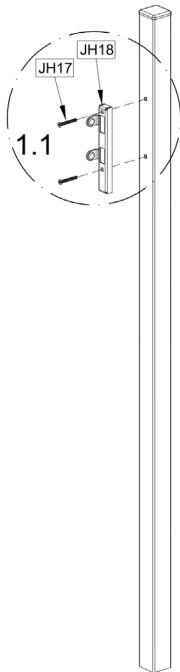

|   |      |          |    |
|---|------|----------|----|
|  | JH02 | 23×10mm  | 4  |
|  | JH03 | 30×1mm   | 10 |
|  | JH04 | 16×120mm | 2  |
|  | JH05 | 15×35mm  | 2  |
|  | JH06 | 22×2mm   | 2  |
|  | JH07 | 7×20mm   | 2  |

