

CASANOVO

DO 500C160

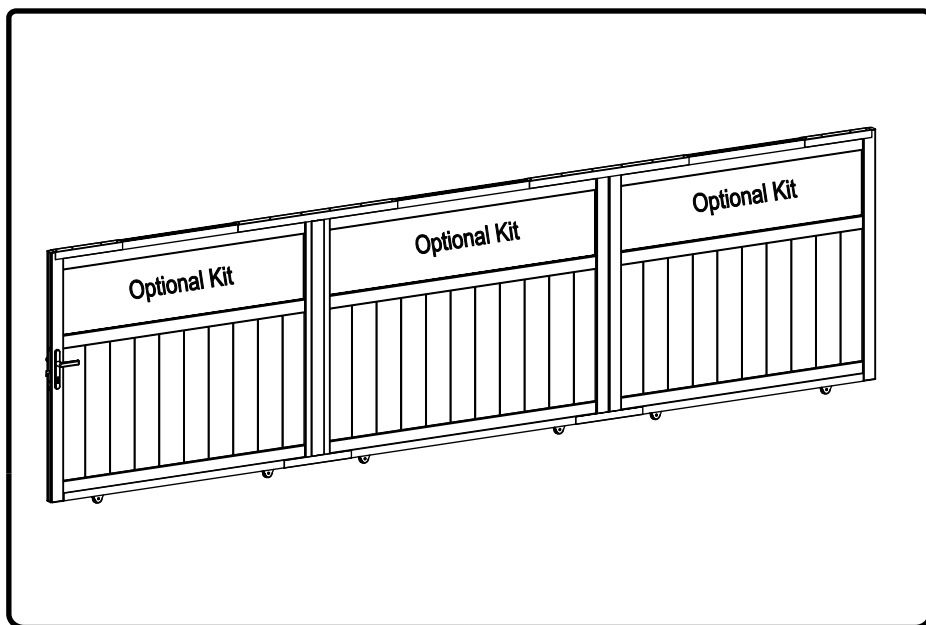

INSTRUCTION MANUAL / NOTICE DE MONTAGE / MONTAGEANLEITUNG / MANUAL DE MONTAJE / MANUAL DE MONTAGEM / MANUALE DI MONTAGGIO /
MONTAGEHANDLEIDING / INSTRUKCJA MONTAŻU / KÄYTTÖOHJEET / BRUKSANVISNING / BRUGSANVISNING / INSTRUCȚIUNI DE ASAMBLARE /
NAVODILA ZA SESTAVLJANJE / NÁVOD NA MONTÁŽ / ÖSSZESZERELÉSI ÚTMUTATÓ / NÁVOD K MONTÁŽI / UPUTE ZA INSTALACIJU /
ΟΔΗΓΙΕΣ ΣΥΝΑΡΜΟΛΟΓΗΣΗΣ / SURINKIMO INSTRUKCIJOS / MONTĀŽAS INSTRUKCIJAS

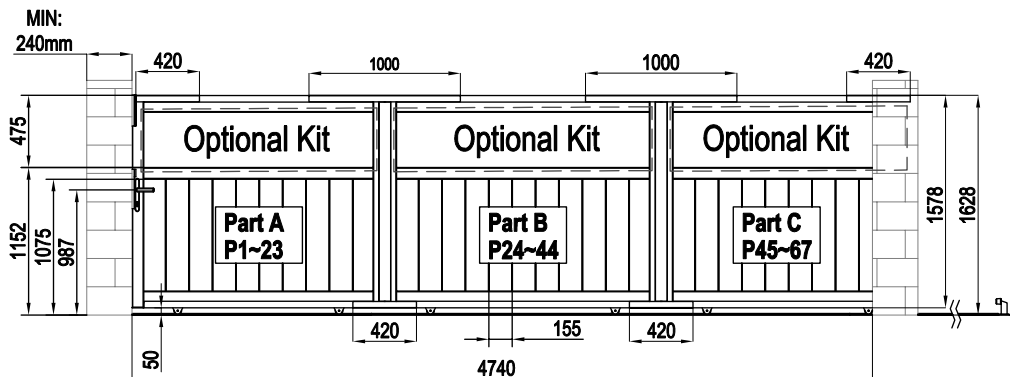

Int.

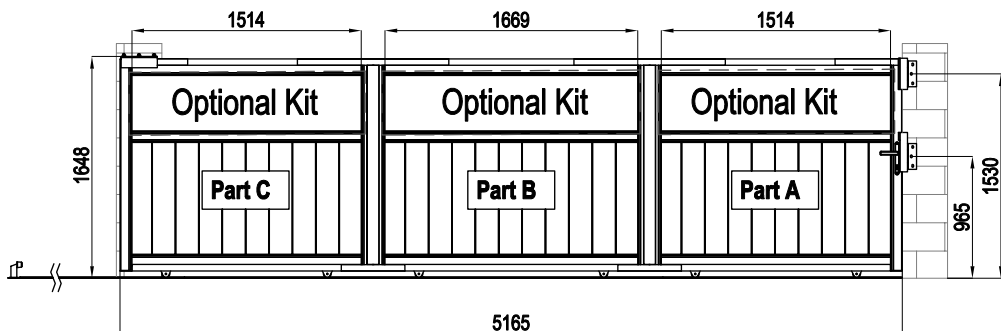

Part B

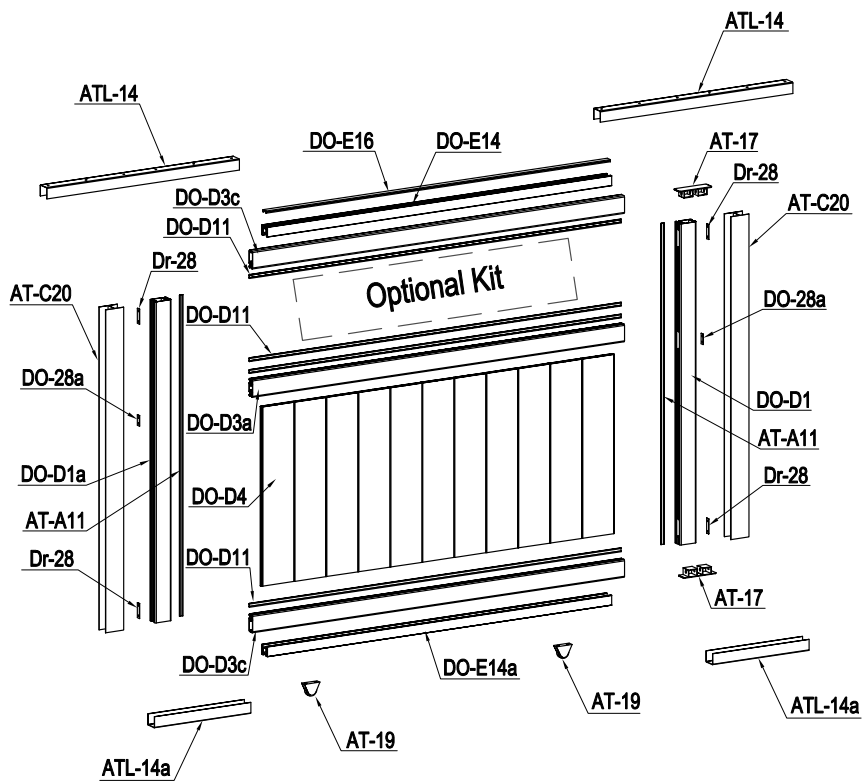

Part C

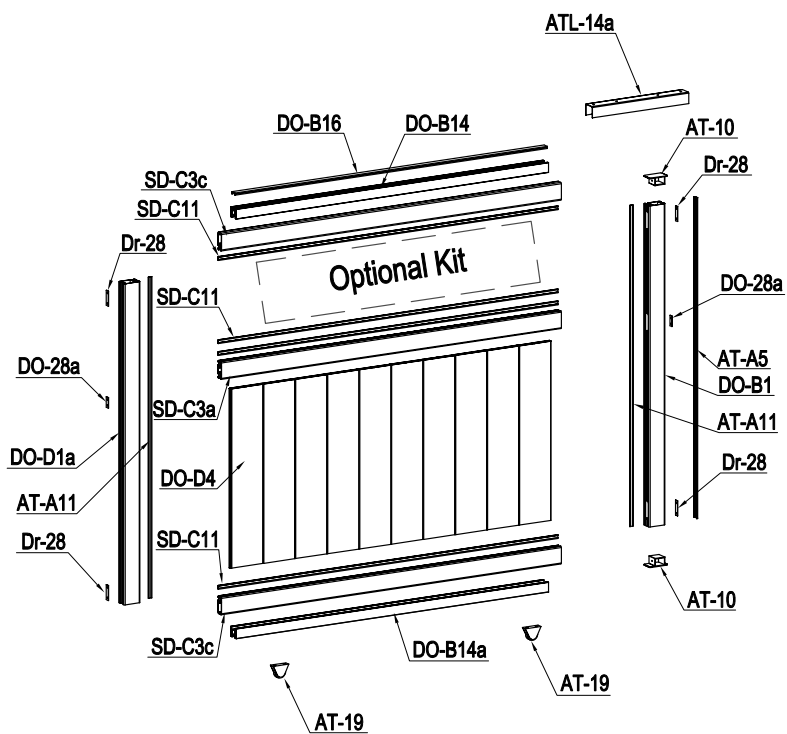

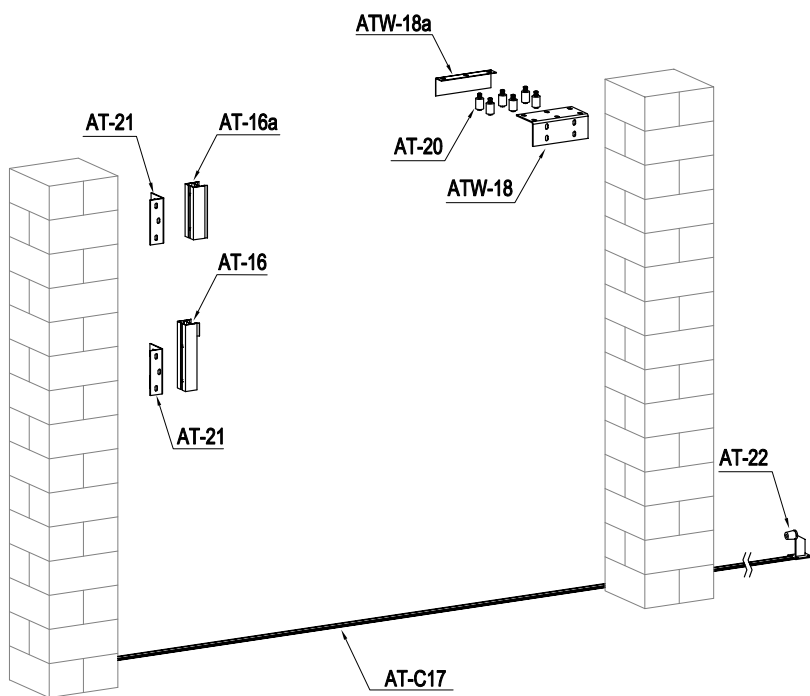

Part A&C

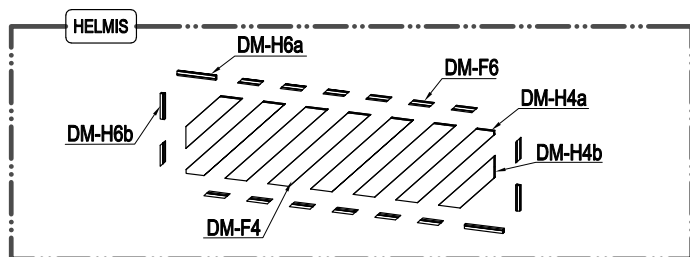
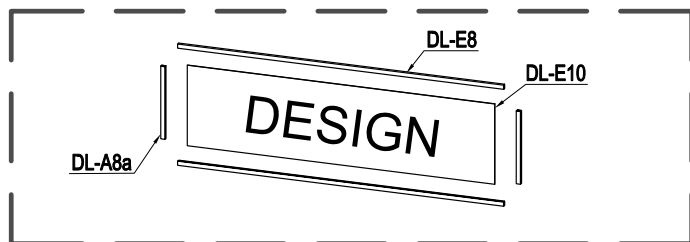
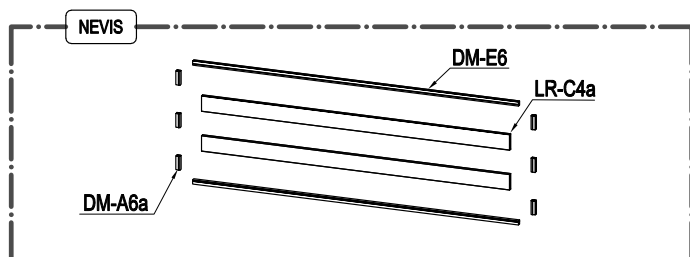
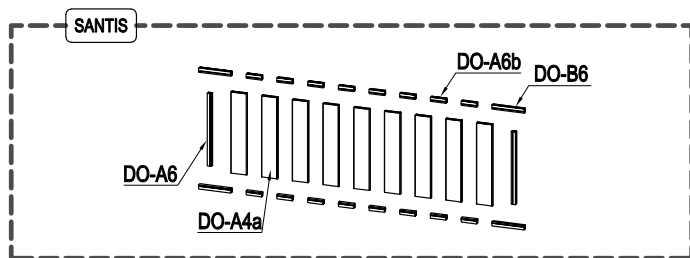



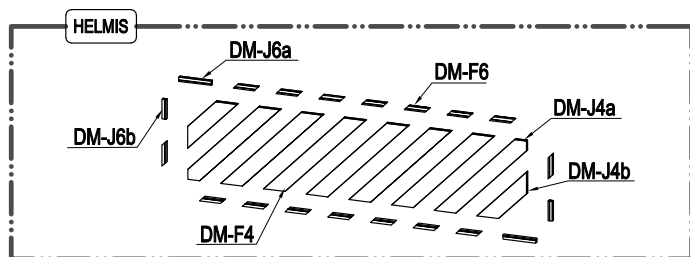
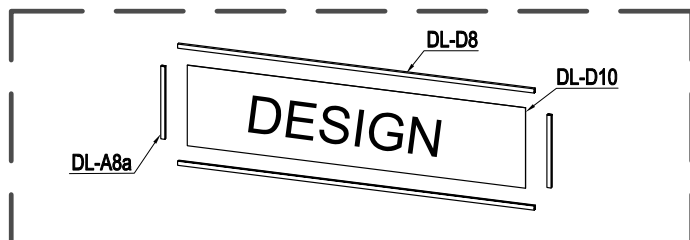
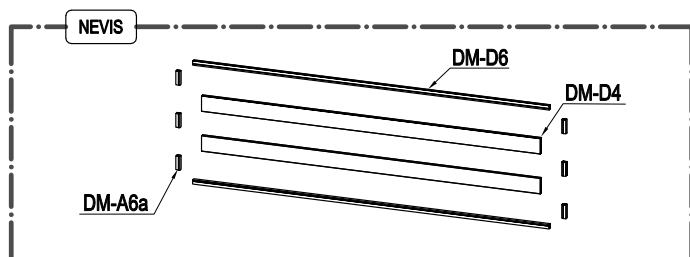
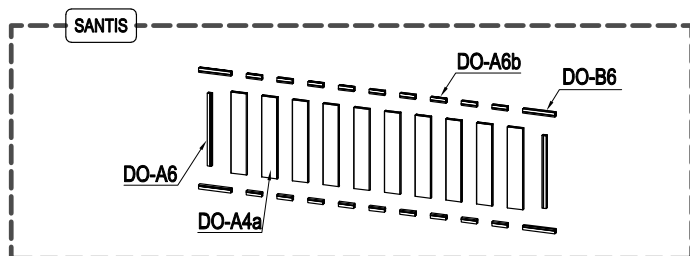

Part B





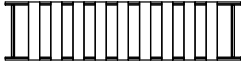



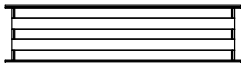

PARTS LIST

IMAGE	NO.	L.(mm)	QTY	IMAGE	NO.	L.(mm)	QTY
	DO-B1	1573	1		ATL-14		2
	DO-D1	1573	2		ATL-14a		4
	DO-D1a	1573	2		AT-19		6
	DO-B2	1573	1		AT-20		6
	SD-C3c	1647	4		AT-21		2
	DO-D3c	1802	2		AT-22		1
	SD-C3a	1647	2		Dr-18		1
	DO-D3a	1802	1		Dr-19		1
	DO-D4	957	31		Dr-20a		1
	AT-A5	1573	1		Dr-21		1
	AT-B5a	550.5	1		Dr-22		1
	SR-A5a	782	1		Dr-25		1
	AT-A11	1573	6		Dr-25a		2
	SD-C11	1647	8		Dr-27		2
	DO-D11	1802	4		Dr-28		12
	DO-B14	1513	2		DO-28a		6
	DO-B14a	1513	2		AT-22J		10
	DO-E14	1668	1		DO-M30	ST4x10	4
	DO-E14a	1668	1		DO-M31	ST5.5x38	50
	DO-B16	1512	2		DO-M32	ST4.8x38	46
	DO-E16	1667	1		DO-M33	M8x60	14
	AT-16		1		DO-M34	ST4x25	60
	AT-16a		1		DO-M35	ST4.2x19	62
	AT-C17	1580	6		DO-M36	M6x20	4
	AT-17		4		DO-M37	M8x20	12
	AT-10		4		DO-M38	M8x130	4
	AT-C20	1493	2				
	DO-30		12				
	ATW-18		1				
	ATW-18a		1				





PARTS LIST (Optional Kit)

	IMAGE	NO.	L.(mm)	QTY
		DO-A4a	406	28
		DO-A6	364	6
		DO-B6	163	12
		DO-A6b	77.5	50
	DO-35		56	

	IMAGE	NO.	L.(mm)	QTY
		DM-D4	1710	2
		LR-C4a	1555	4
		DM-D6	1800	2
		DM-A6a	69	18
		DM-E6	1654	4
		DO-32		12

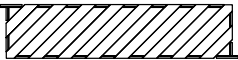
	IMAGE	NO.	L.(mm)	QTY
		DL-D8	1800	2
		DL-E8	1645	4
		DL-A8a	364	6
		DL-D10	1707	1
		DL-E10	1552	2
		DO-32		12
	DO-35		28	

PARTS LIST (Optional Kit)

	IMAGE	NO.	L.(mm)	QTY
		DM-F4	651	13
		DM-H4a	637	4
		DM-H4b	397	4
		DM-J4a	616	2
		DM-J4b	354	2
		DM-F6	126	44
		DM-H6a	195	4
		DM-H6b	128	4
		DM-J6a	165	2
		DM-J6b	98	2
		DO-32		8
		DO-35		44

Part A

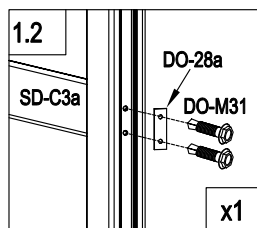
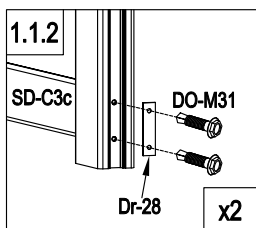
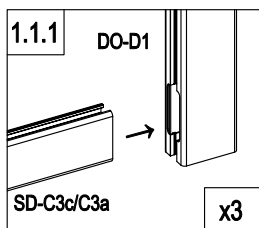
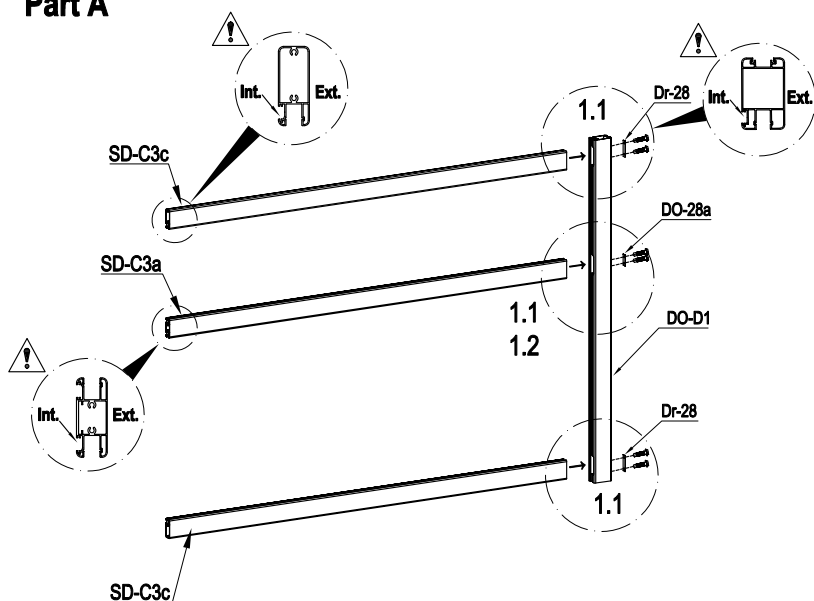

	DO-D1	1
	SD-C3c	2
	SD-C3a	1

	Dr-28	2
	DO-28a	1
	DO-M31	6

Part A

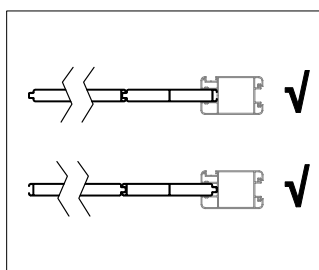
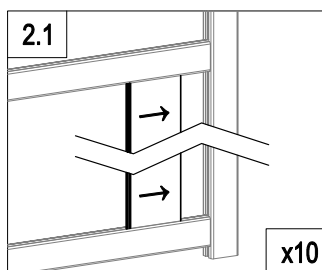
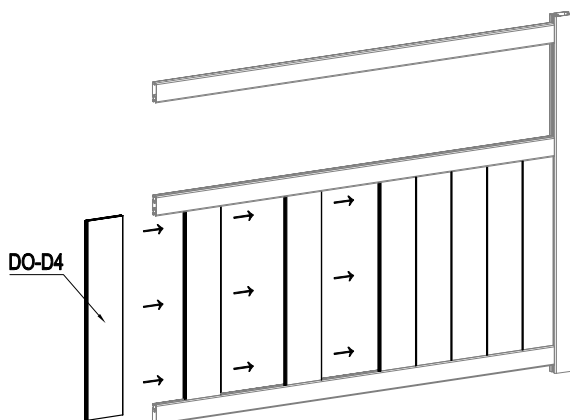

	DO-D4	10
---	-------	----

Part A

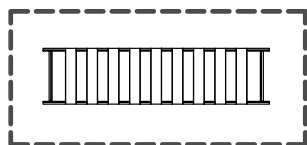
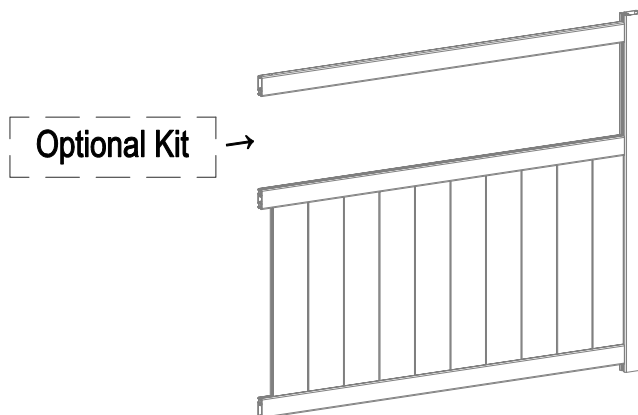

P: 15~18

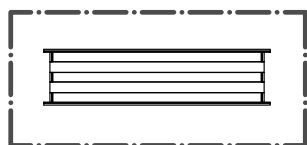

P: 19~22



P: 23~25

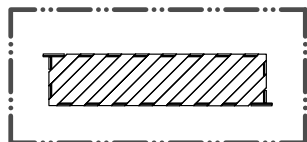

P: 26~30

Part A

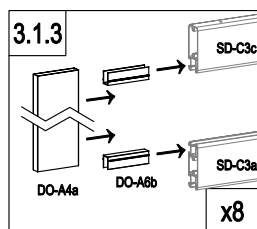
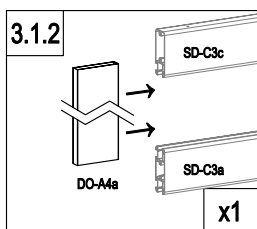
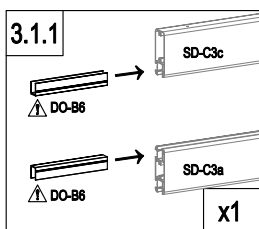
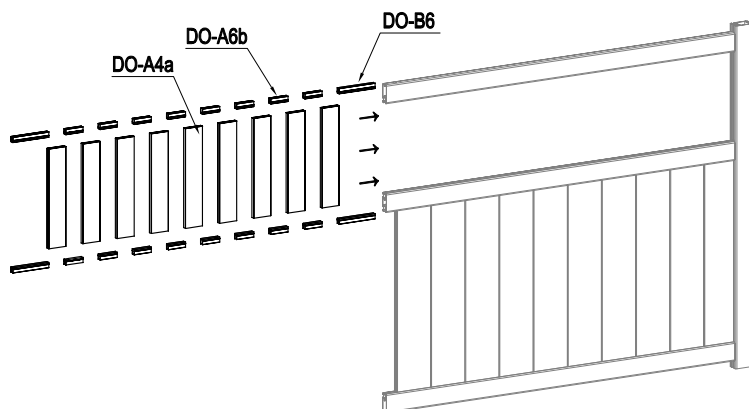
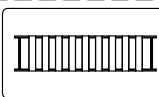

	DO-A4a	9
	DO-B6	4
	DO-A6b	16

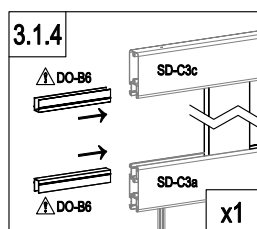

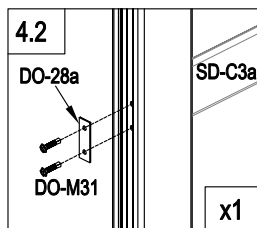
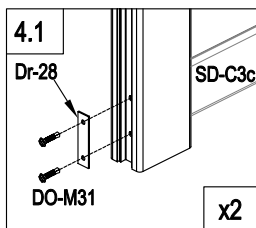
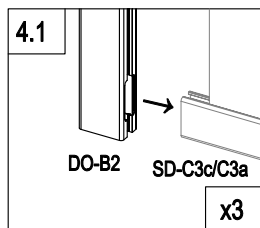
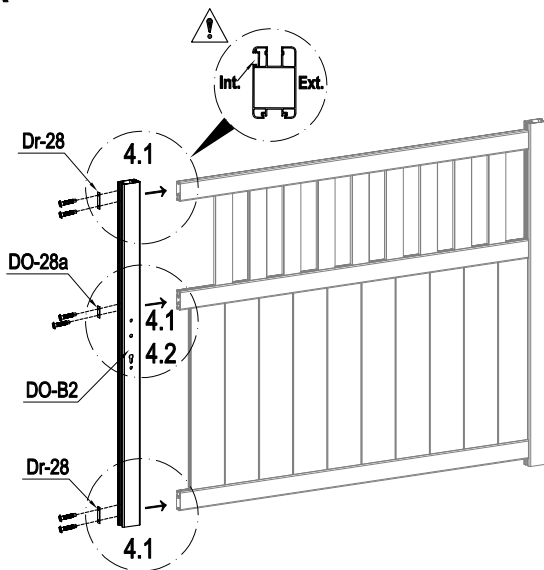
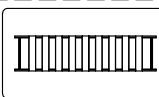

Part A

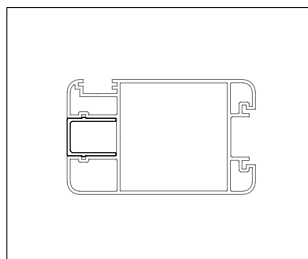
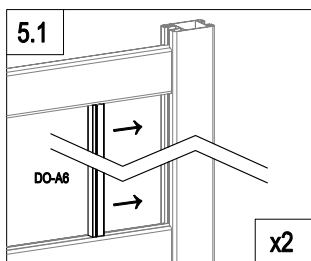
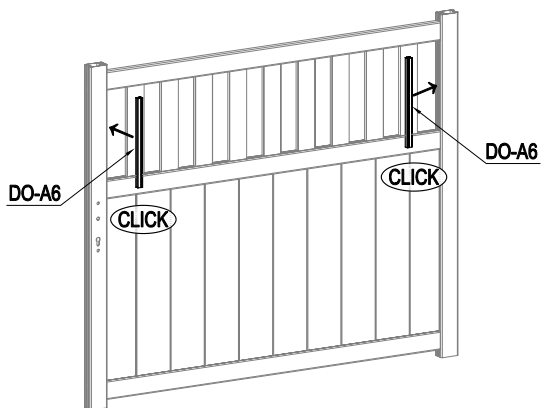
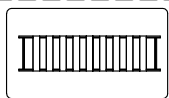

	DO-B2	1
	Dr-28	2
	DO-28a	1
	DO-M31	6

Part A





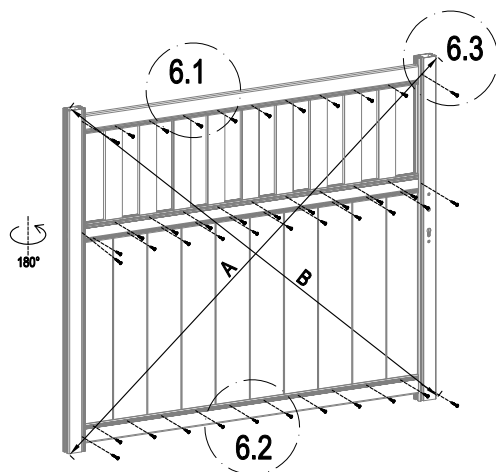

	DO-A6	2
---	-------	---

Part A

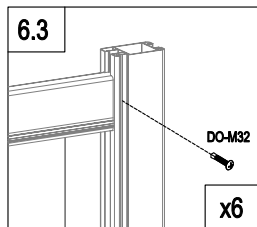
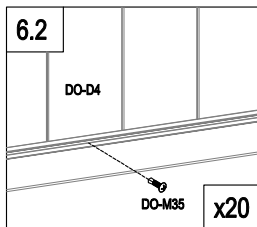
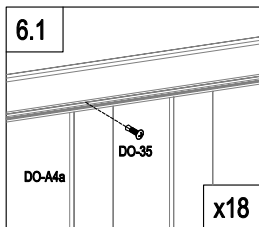

! A=B



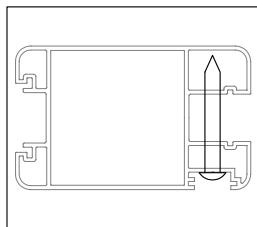
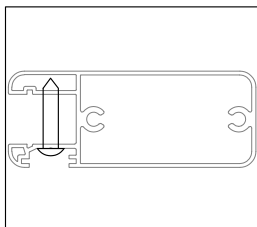

	DO-35	18
	DO-M35	20
	DO-M32	6

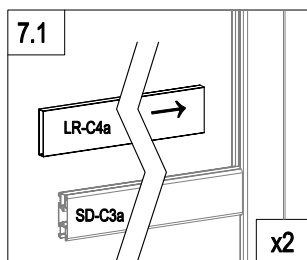
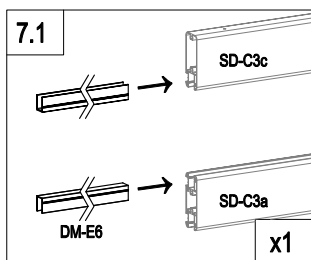
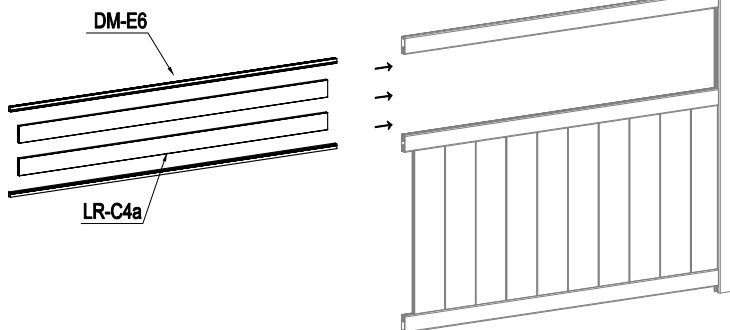
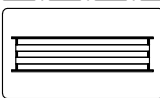

Part A



	LR-C4a	2
	DM-E6	2

Part A

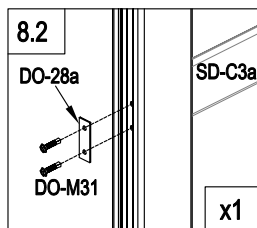
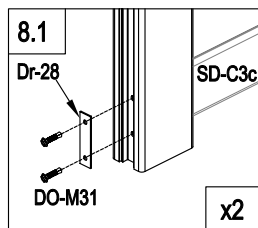
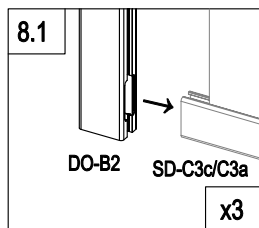
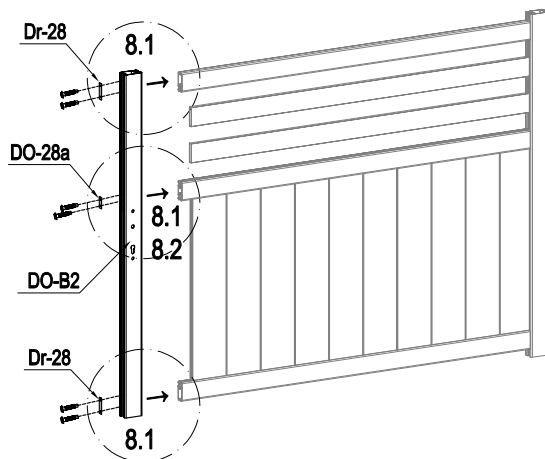
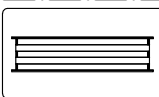

	DO-B2	1
	Dr-28	2
	DO-28a	1
	DO-M31	6

Part A

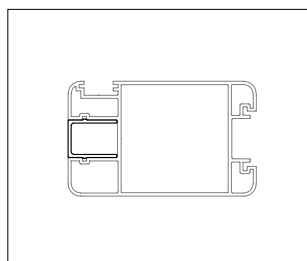
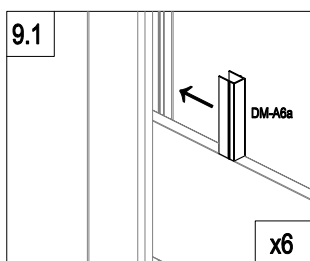
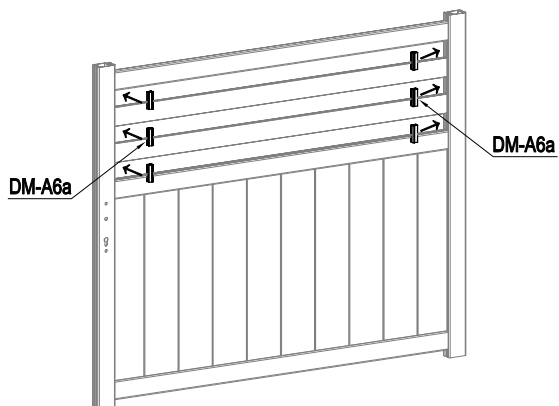
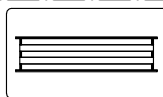



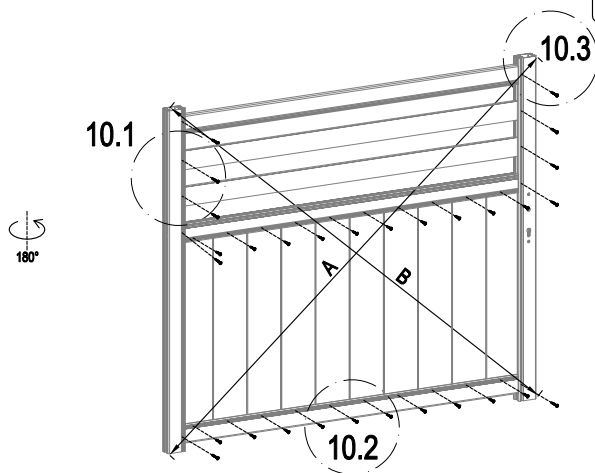

	DM-A6a	6
---	--------	---

Part A

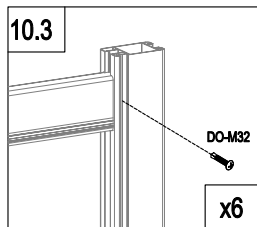
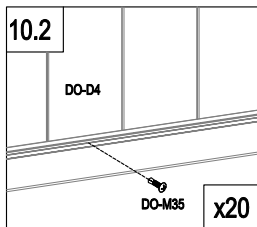
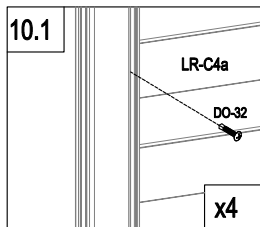

A=B



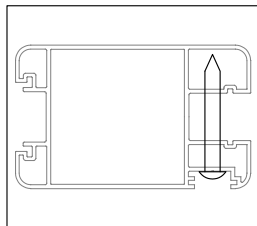
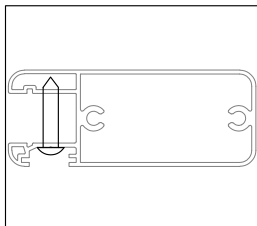

	DO-32	4
	DO-M35	20
	DO-M32	6

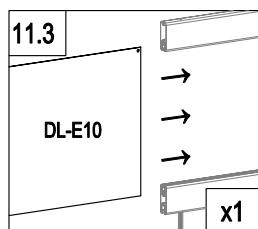
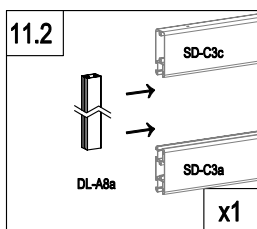
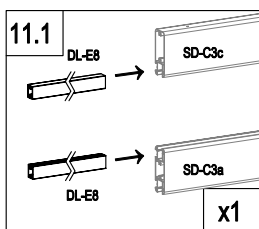
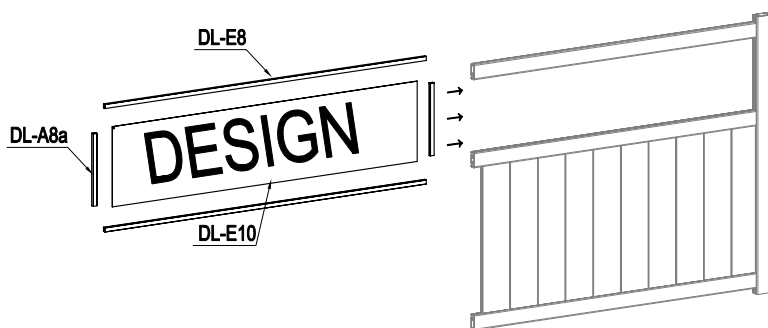

Part A

DESIGN



DESIGN	DL-E10	1
	DL-E8	2
	DL-A8a	2

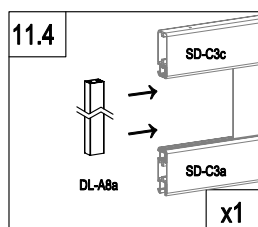

Part A

DESIGN

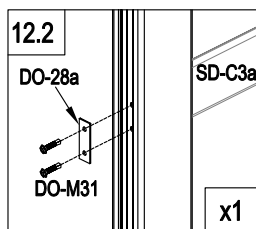
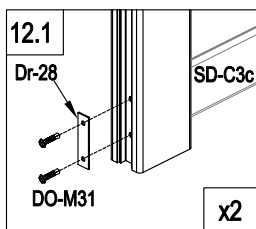
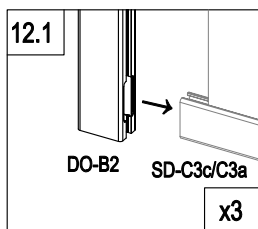
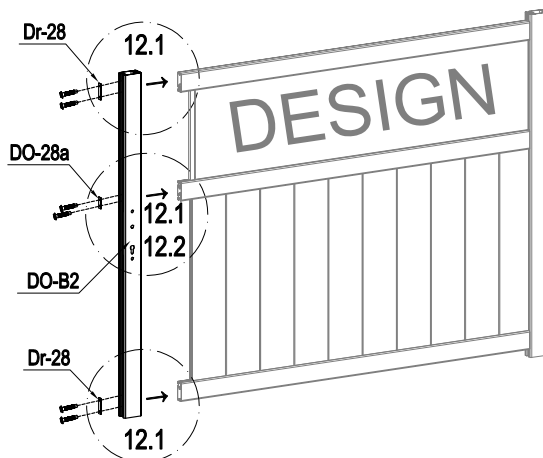

	DO-B2	1
	Dr-28	2
	DO-28a	1
	DO-M31	6

Part A

DESIGN

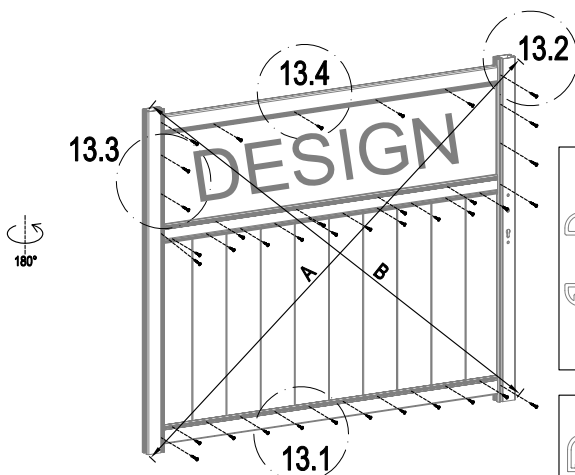

A=B

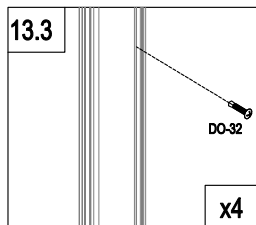
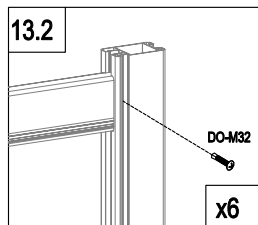
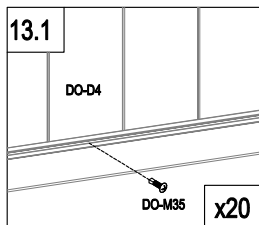
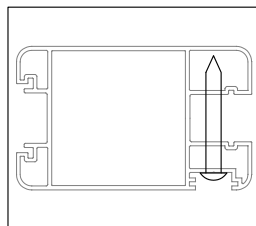
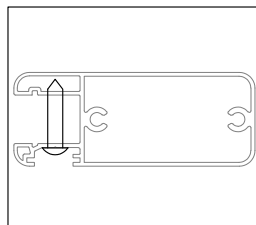

	DO-32	4
	DO-35	8
	DO-M35	20
	DO-M32	6

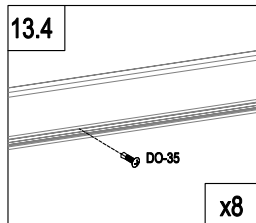

Part A

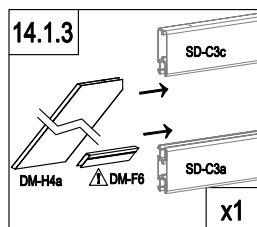
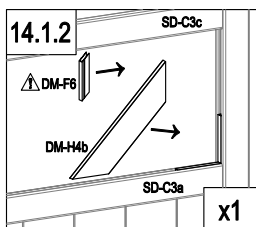
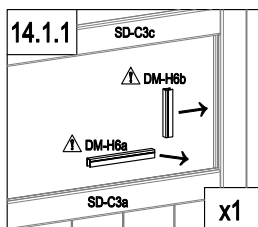
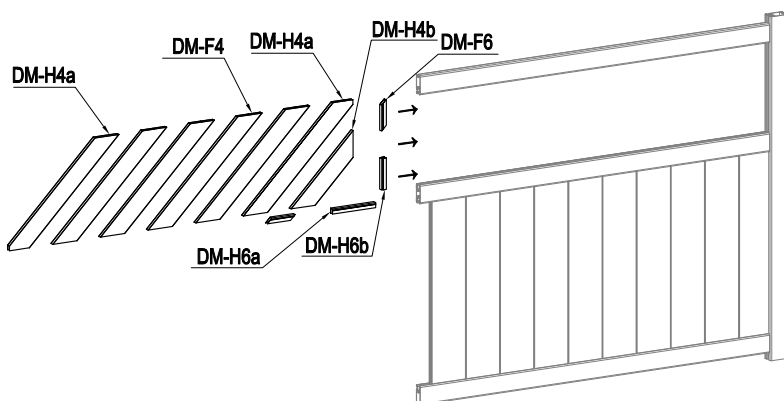
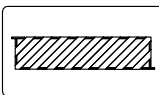

	DM-F4	4
	DM-H4a	2
	DM-H4b	1
	DM-F6	2
	DM-H6a	1
	DM-H6b	1

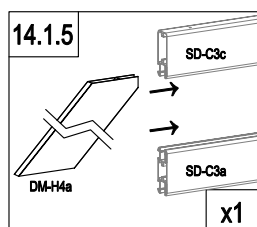
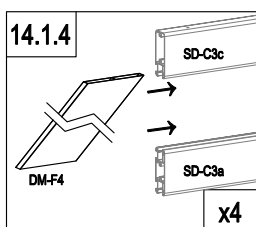

Part A

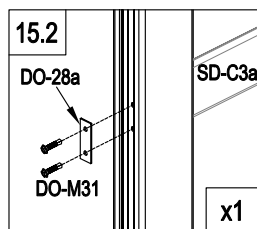
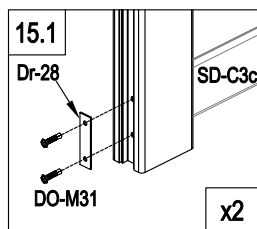
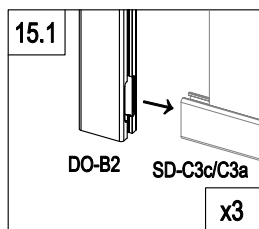
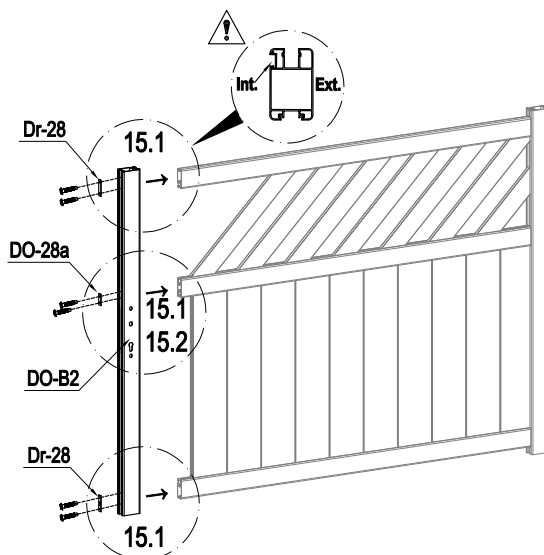
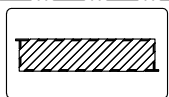

	DO-B2	1
	Dr-28	2
	DO-28a	1
	DO-M31	6

Part A

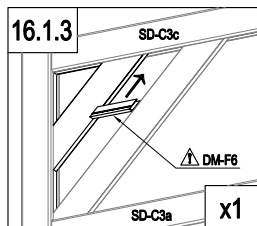
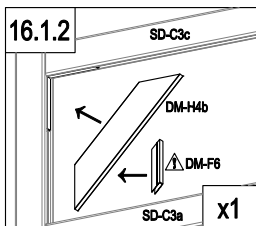
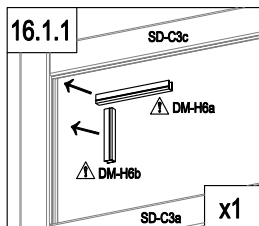
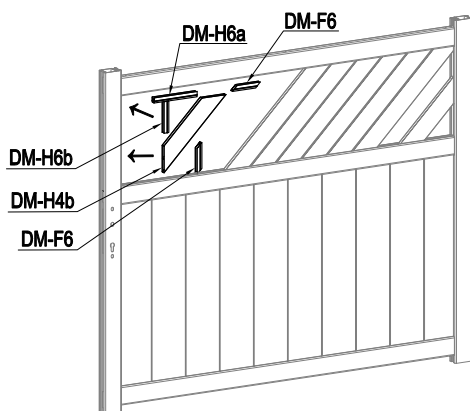
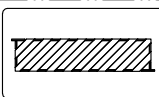

	DM-H4b	1
	DM-F6	2
	DM-H6a	1
	DM-H6b	1

Part A

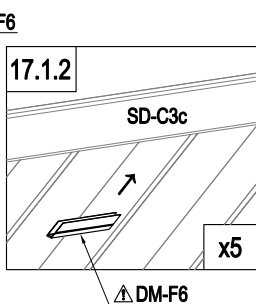
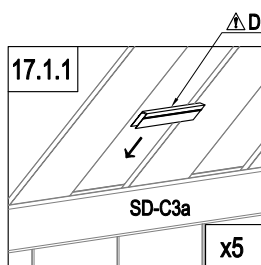
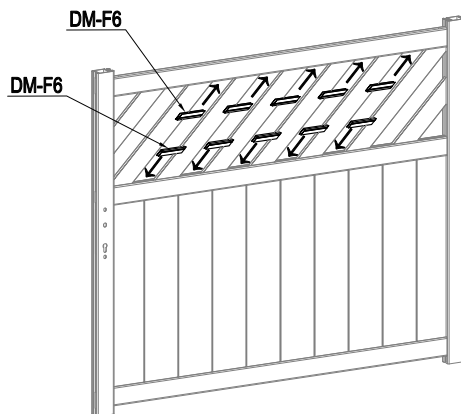
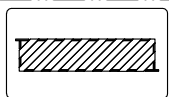

	DM-F6	10
--	-------	----

Part A

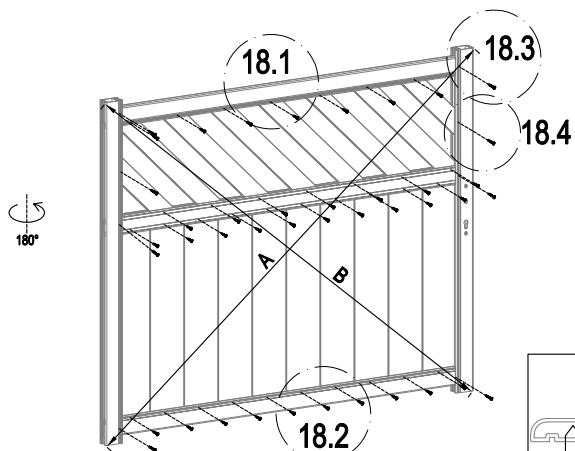
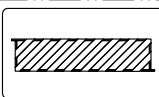

! A=B

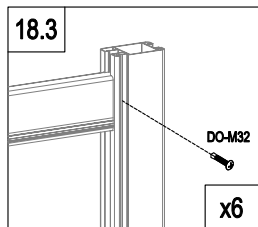
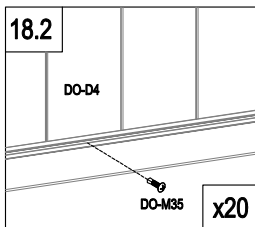
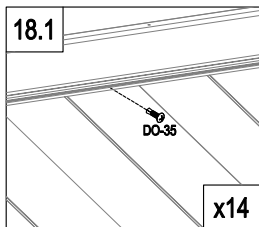
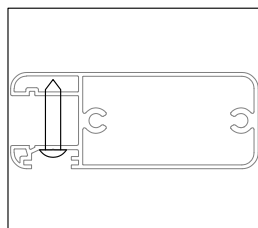

	DO-32	2
	DO-35	14
	DO-M35	20
	DO-M32	6

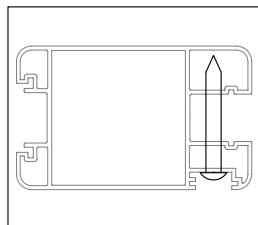
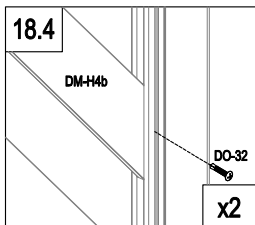

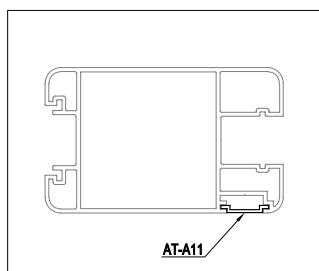
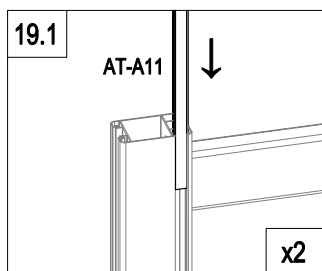
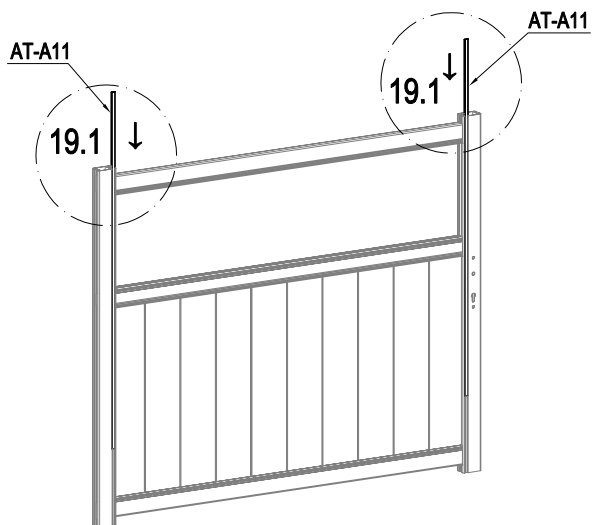

Part A

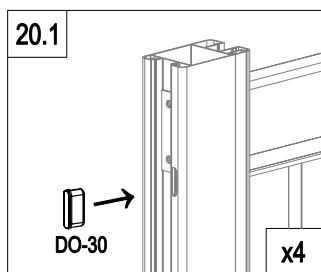
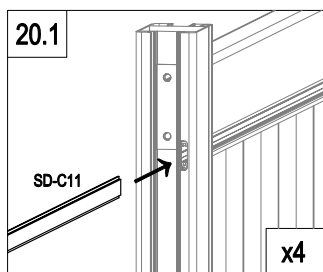
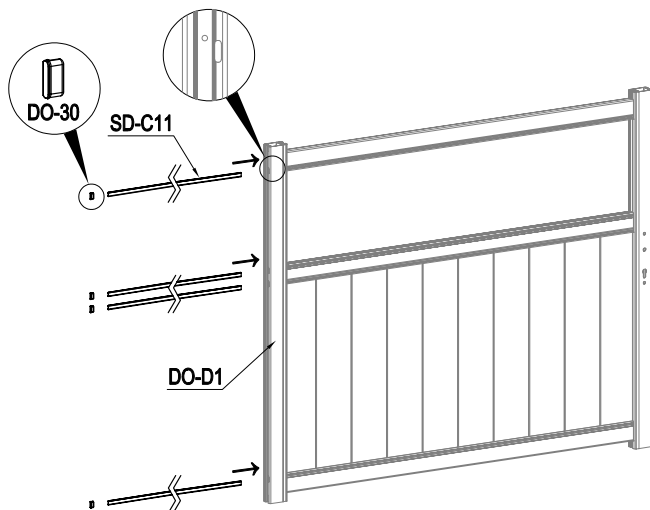

	AT-A11	2
---	--------	---

Part A



	SD-C11	4
	DO-30	4

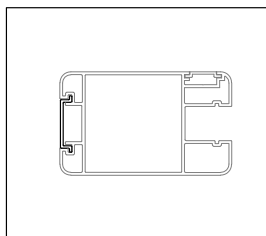
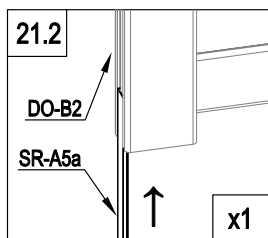
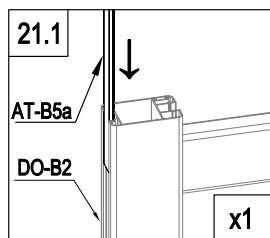
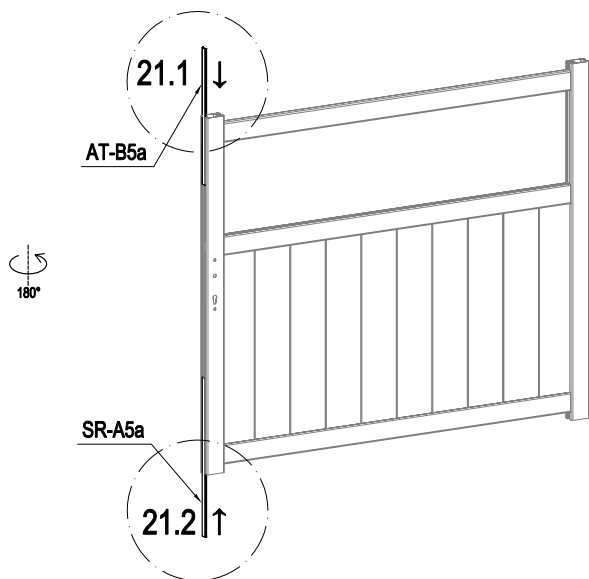

Part A

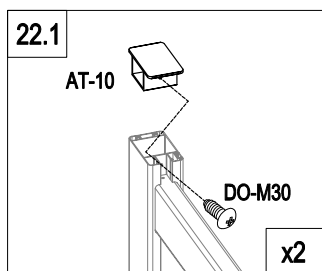
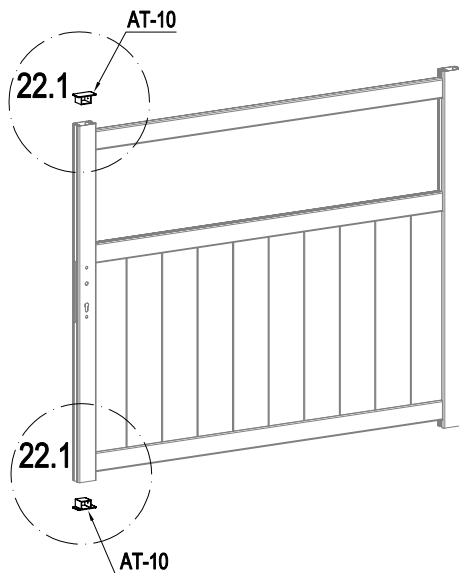

	AT-B5a	1
	SR-A5a	1

Part A



	AT-10	2
	DO-M30	2

Part B

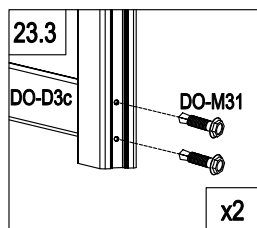
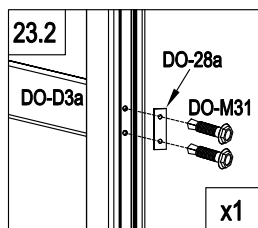
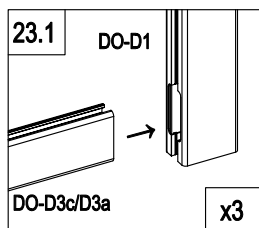
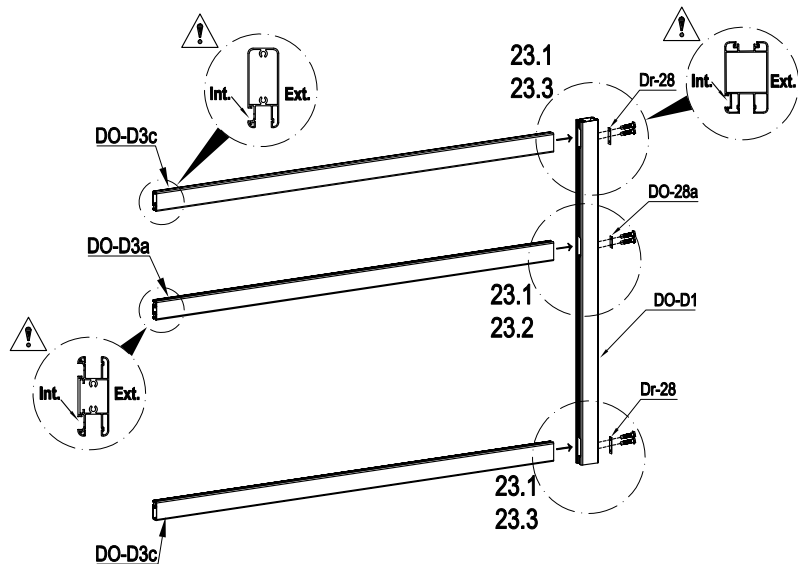

	DO-D1	1
	DO-D3c	2
	DO-D3a	1

	Dr-28	2
	DO-28a	1
	DO-M31	6

Part B

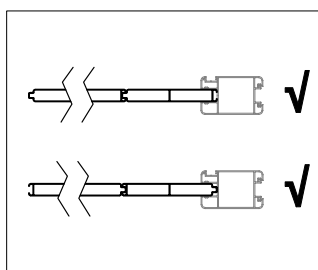
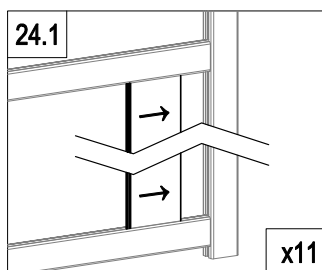
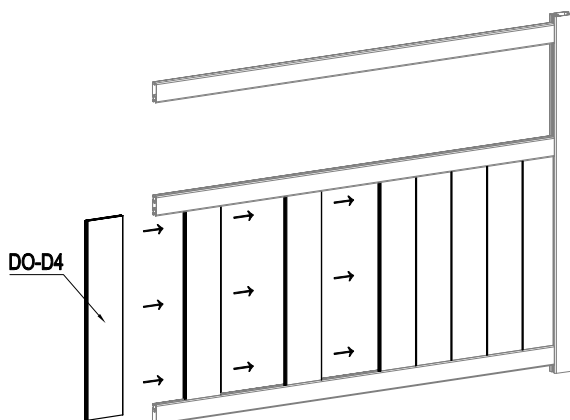

	DO-D4	11
--	-------	----

Part B

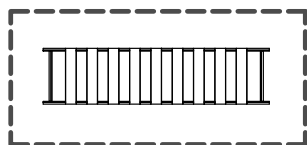
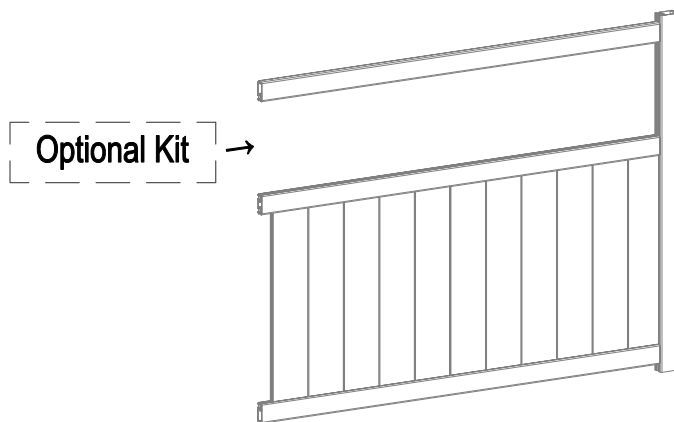

P: 38~41

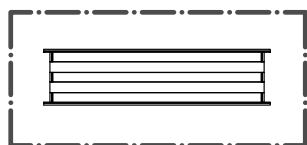

P:42~45



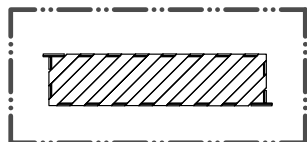

P:46~48

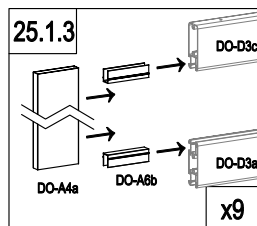
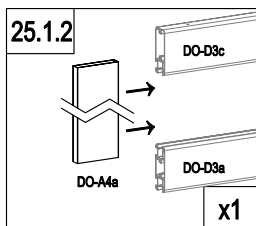
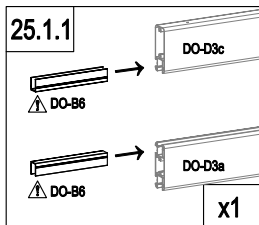
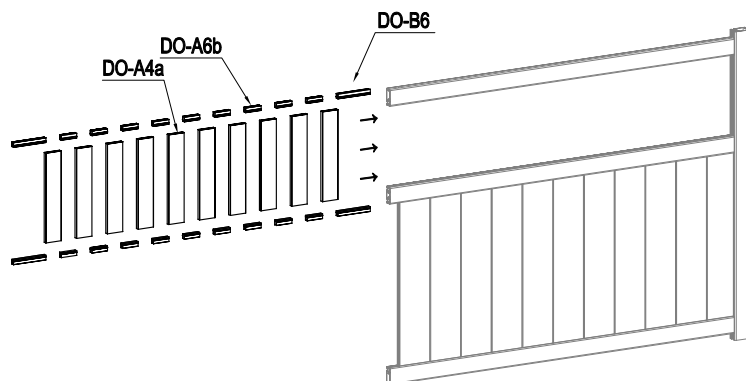

P:49~53

Part B



	DO-A4a	406mm	10
	DO-B6	163mm	4
	DO-A6b	77.5mm	18

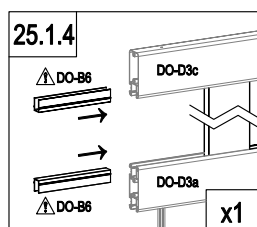

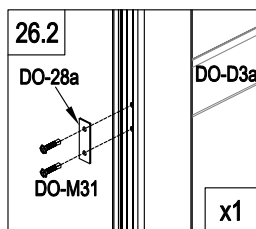
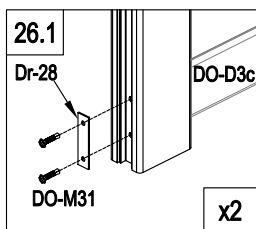
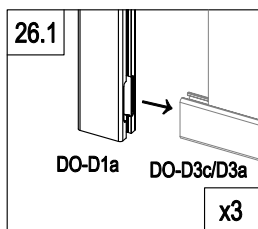
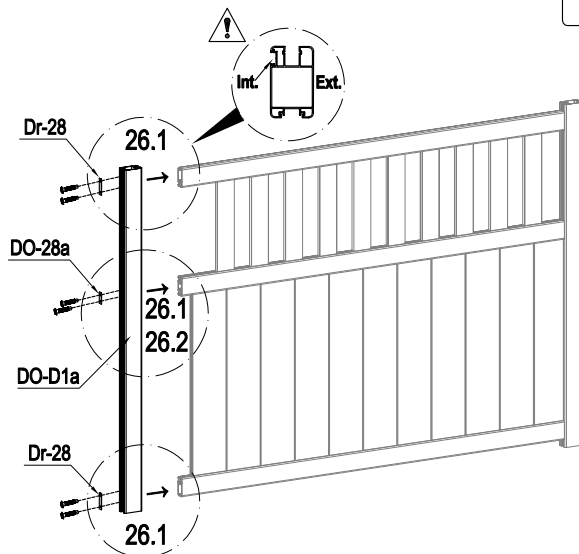
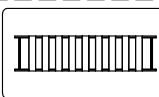

Part B

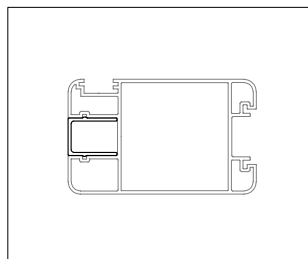
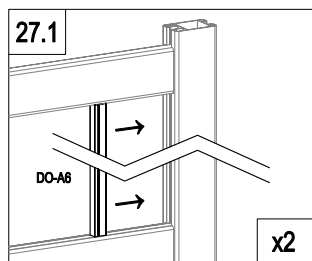
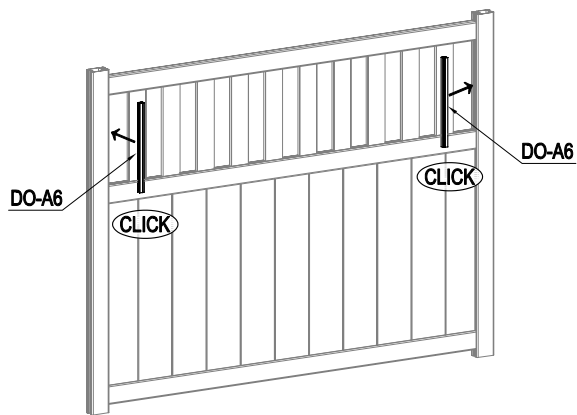
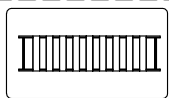

	DO-D1a	1
	Dr-28	2
	DO-28a	1
	DO-M31	6

Part B



	DO-A6	2
---	-------	---

Part B

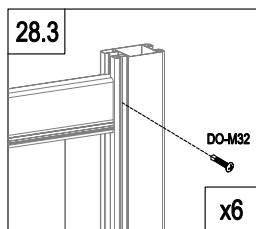
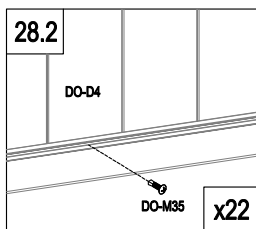
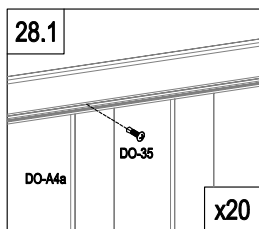
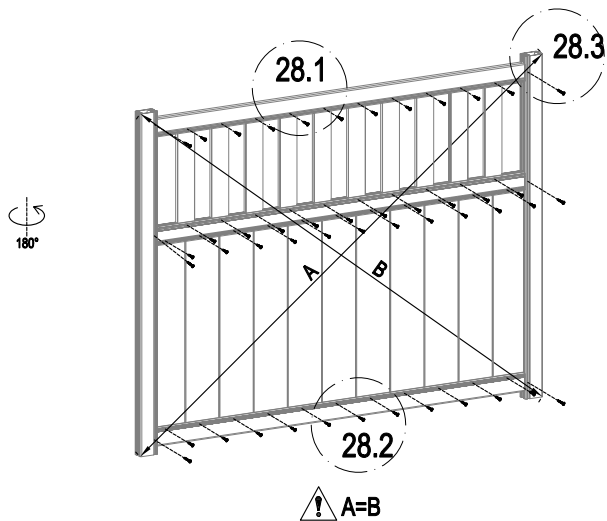
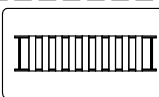

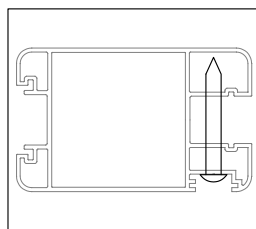
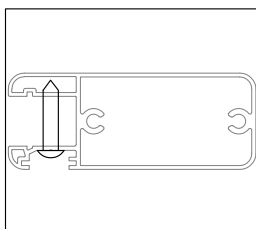

	DO-35	20
	DO-M35	22
	DO-M32	6

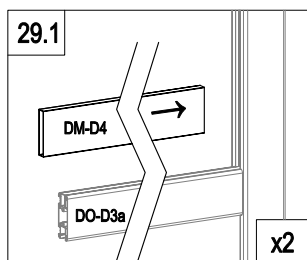
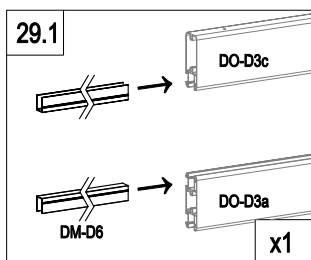
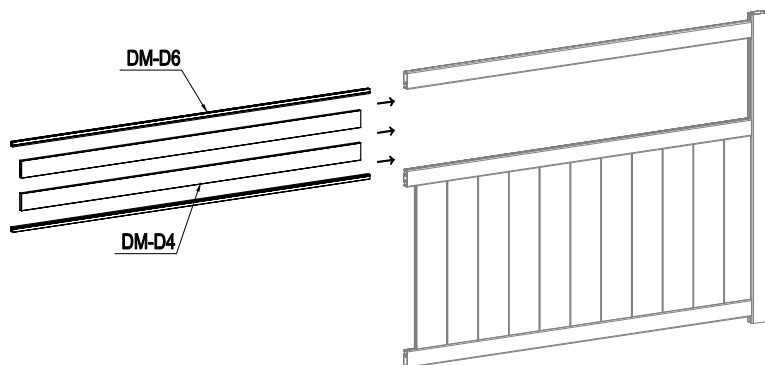
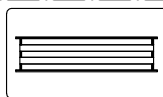

Part B



	DM-D4	2
	DM-D6	2

Part B

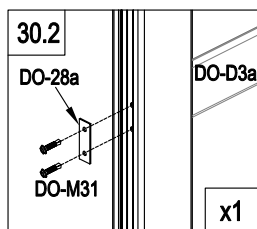
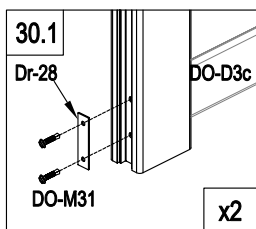
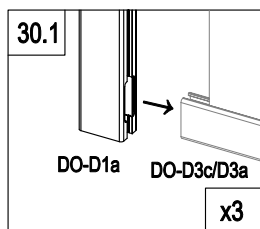
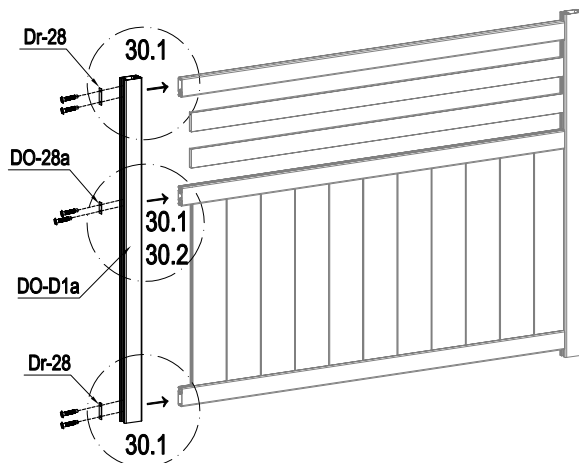
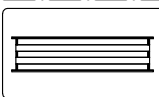

	DO-D1a	1
	Dr-28	2
	DO-28a	1
	DO-M31	6

Part B

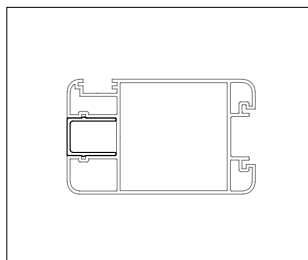
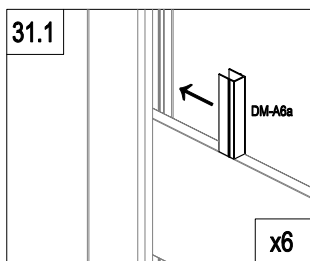
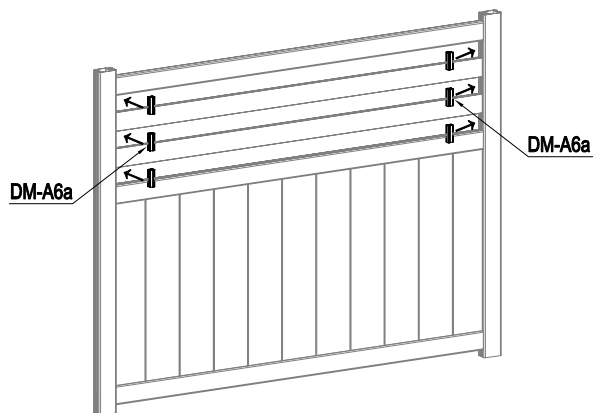
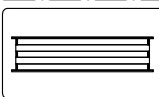

	DM-A6a	6
---	--------	---

Part B

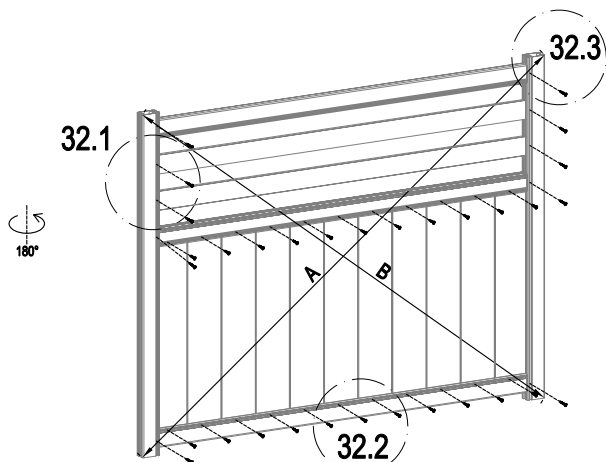
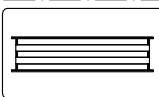

A=B

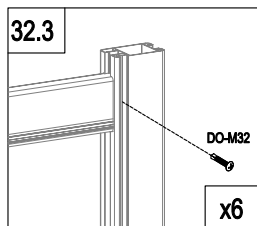
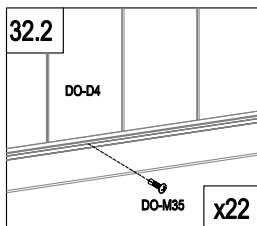
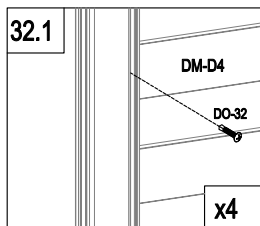

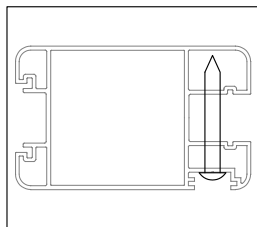
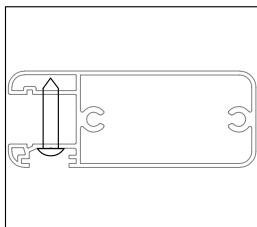

	DO-32	4
	DO-M35	22
	DO-M32	6

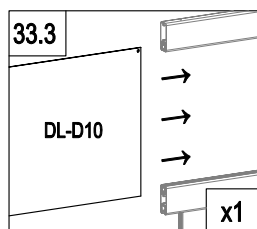
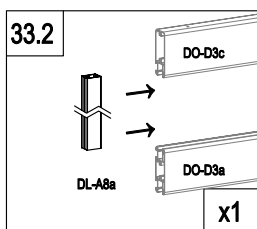
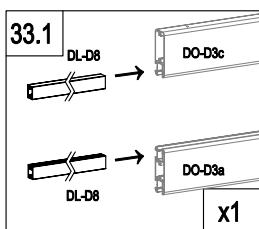
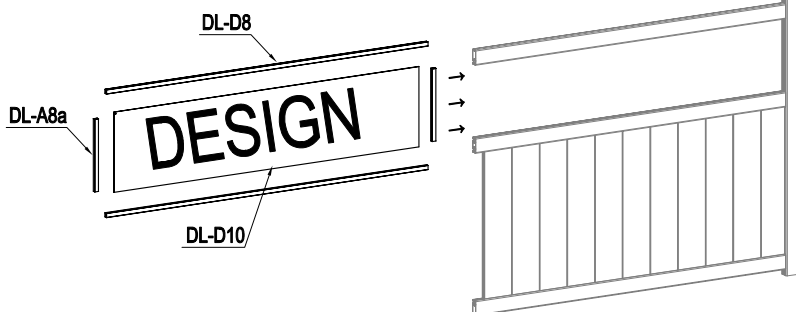

Part B

DESIGN



DESIGN	DL-D10	1
	DL-D8	2
	DL-A8a	2

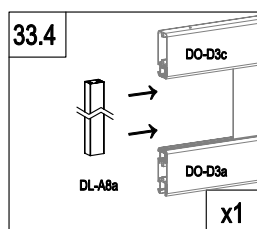

Part B

DESIGN

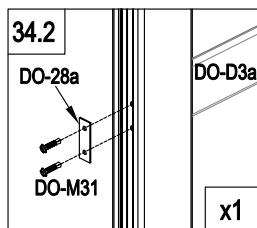
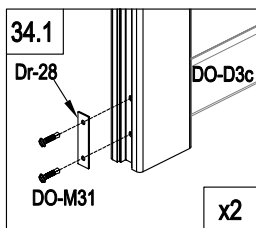
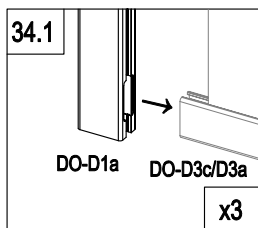
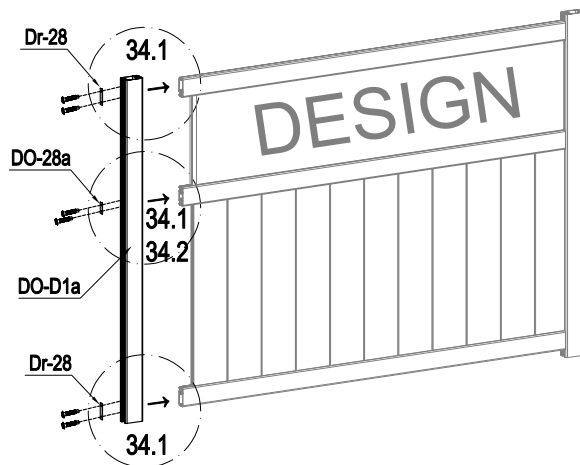

	DO-D1a	1
	Dr-28	2
	DO-28a	1
	DO-M31	6

Part B

DESIGN

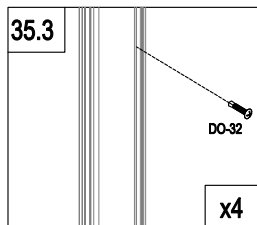
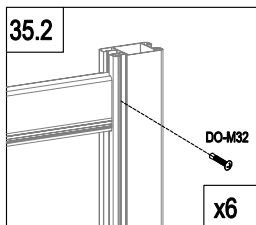
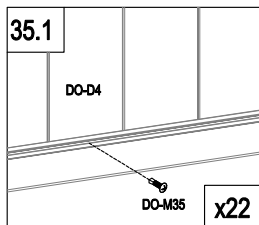
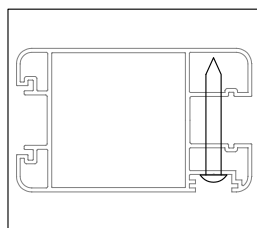
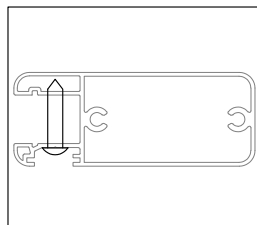
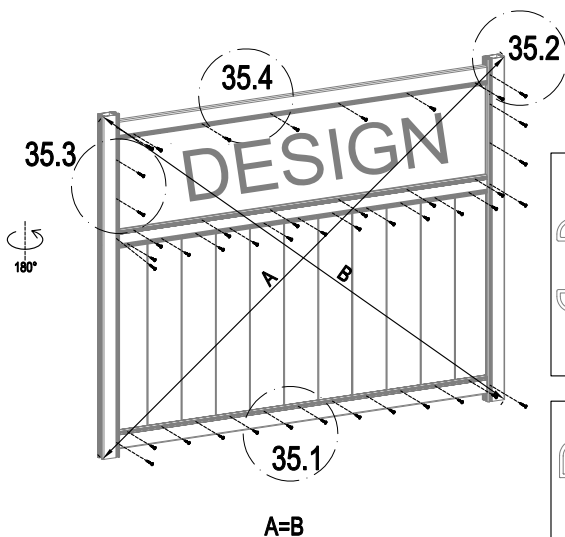

	DO-32	4
	DO-35	12
	DO-M35	22
	DO-M32	6

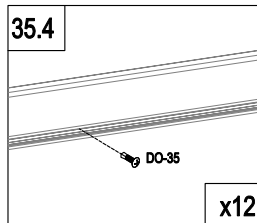

Part B

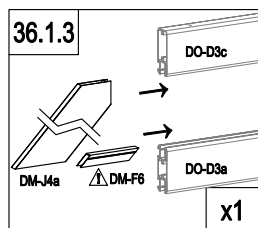
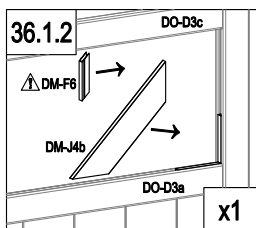
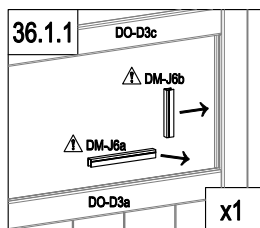
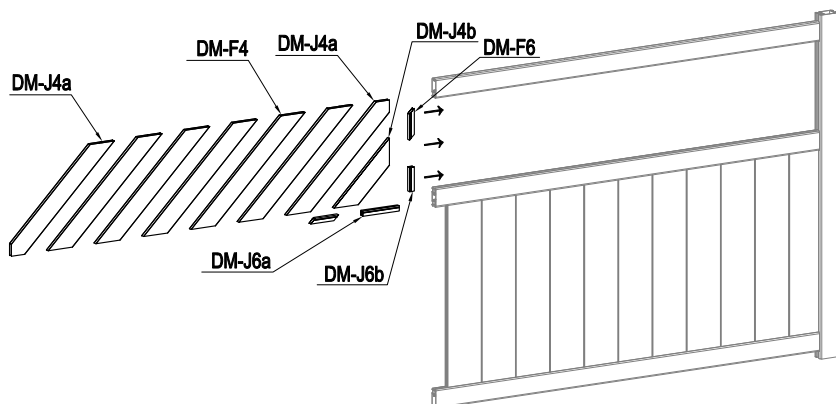
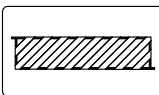

	DM-F4	5
	DM-J4a	2
	DM-J4b	1
	DM-F6	2
	DM-J6a	1
	DM-J6b	1

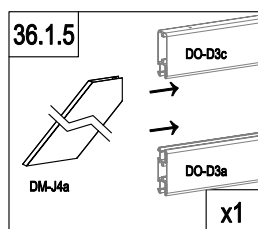
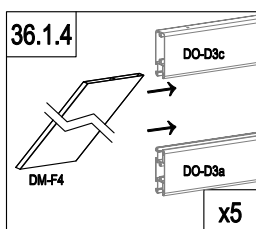

Part B

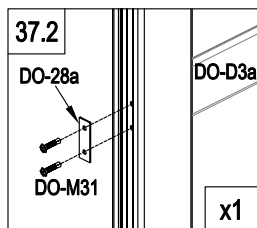
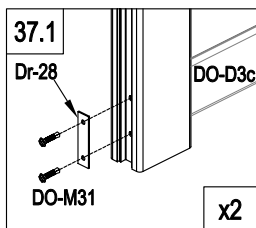
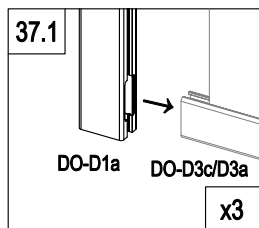
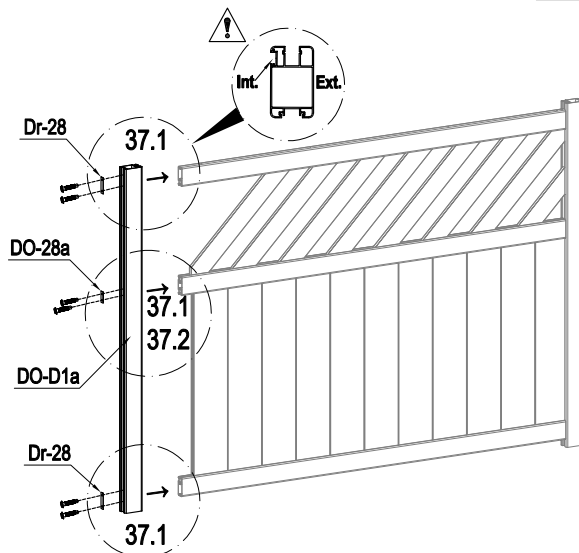
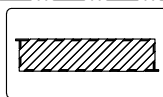

	DO-D1a	1
	Dr-28	2
	DO-28a	1
	DO-M31	6

Part B

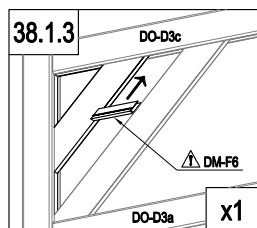
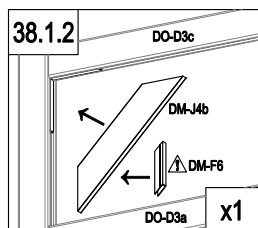
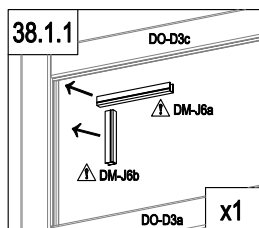
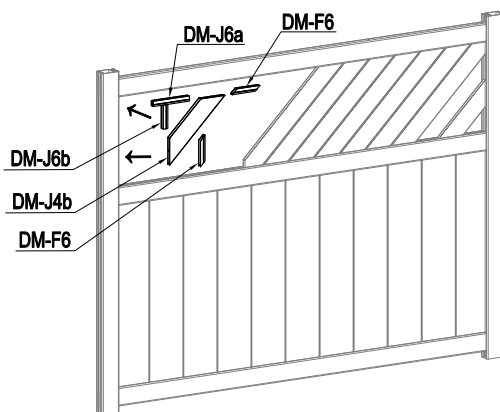
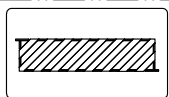

	DM-J4b	1
	DM-F6	2
	DM-J6a	1
	DM-J6b	1

Part B

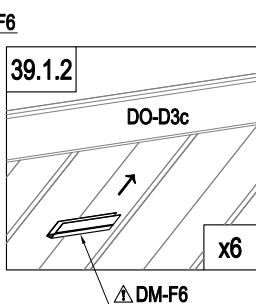
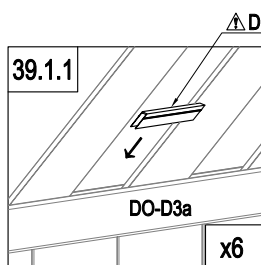
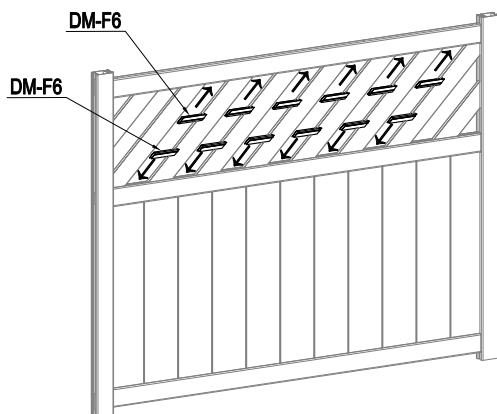
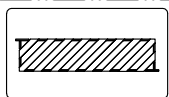

	DM-F6	12
---	-------	----

Part B

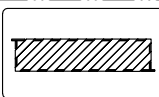
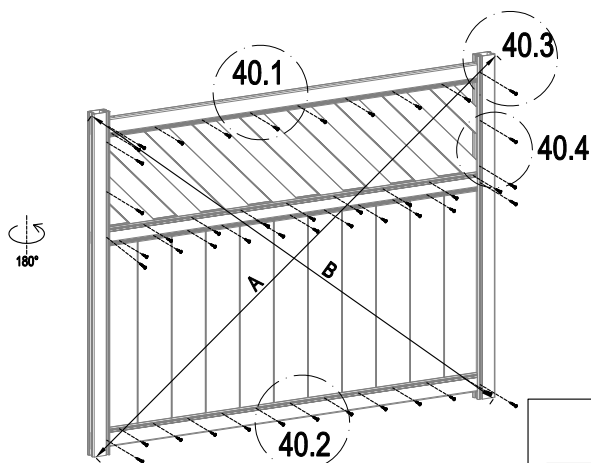

! A=B

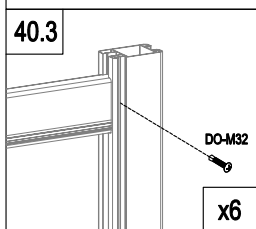
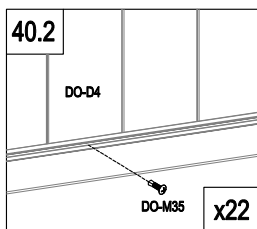
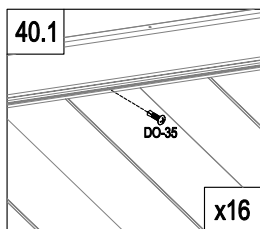
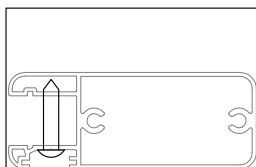

	DO-32	4
	DO-35	16
	DO-M35	22
	DO-M32	6

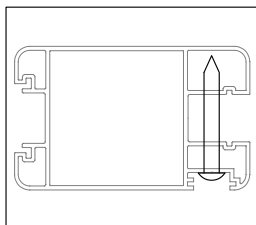
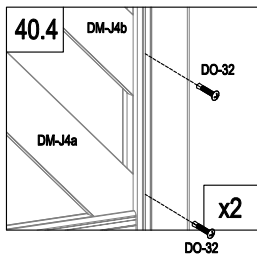

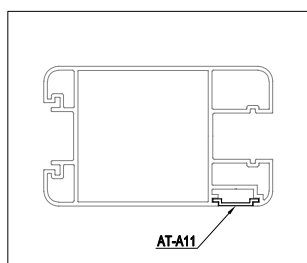
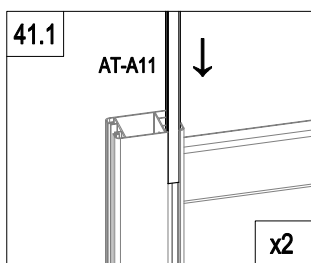
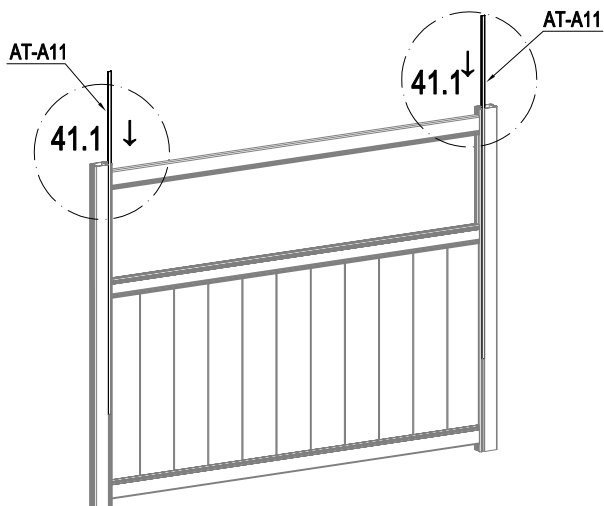

Part B

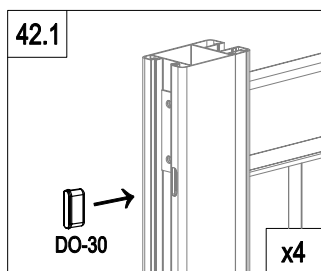
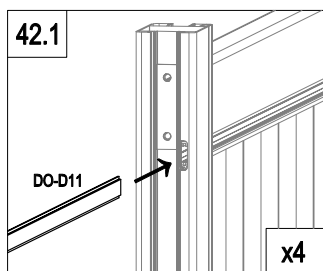
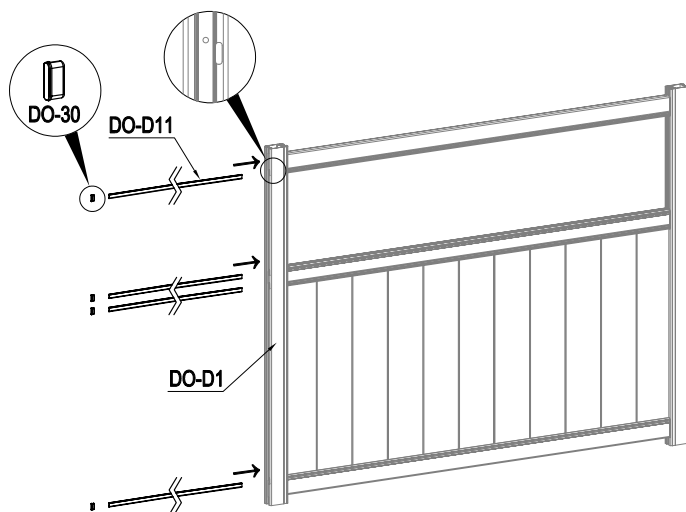

	AT-A11	2
---	--------	---

Part B



	DO-D11	4
	DO-30	4

Part C

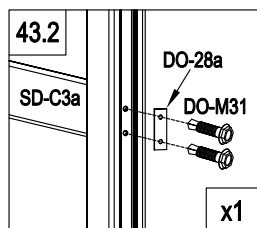
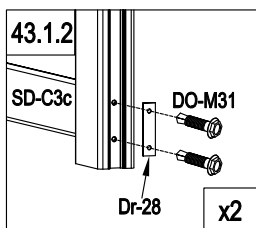
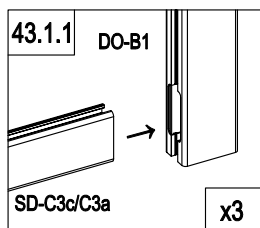
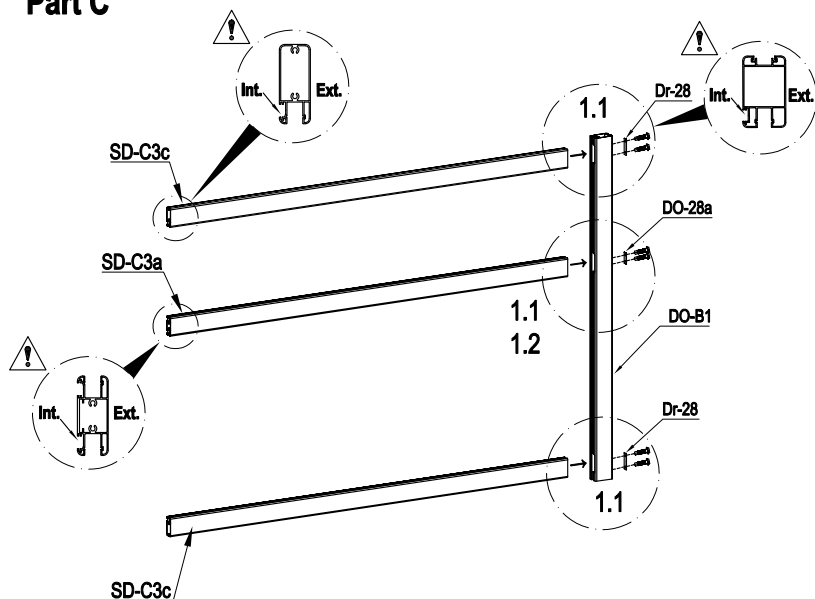

	DO-B1	1
	SD-C3c	2
	SD-C3a	1

	Dr-28	2
	DO-28a	1
	DO-M31	6

Part C

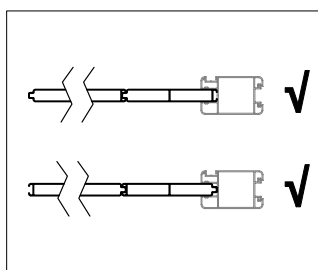
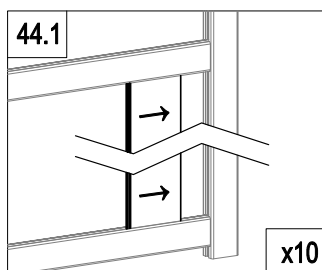
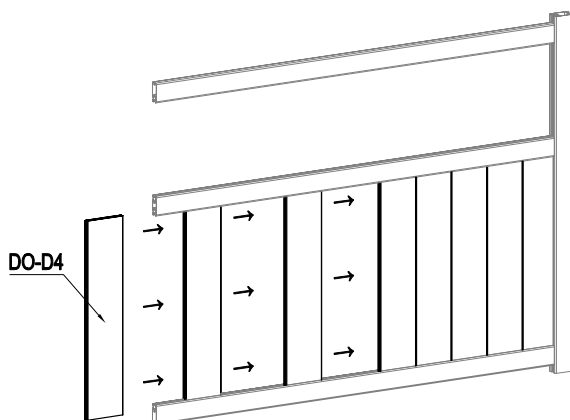

	DO-D4	10
---	-------	----

Part C

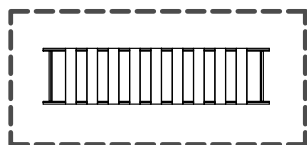
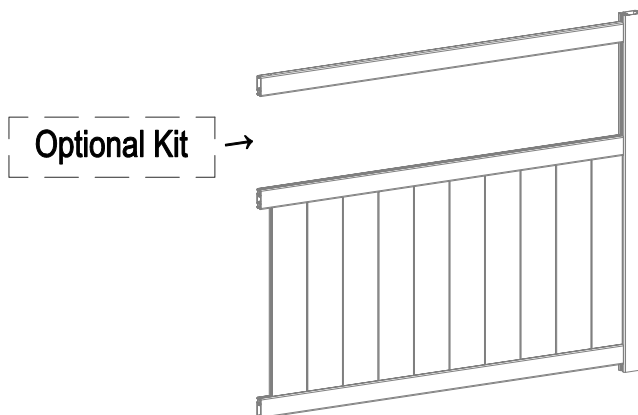

P:59~62

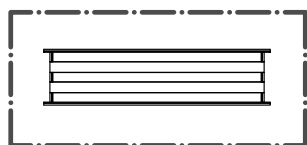

P:63~66



P:67~69



P:70~74

Part C

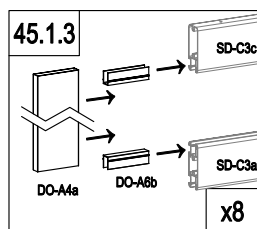
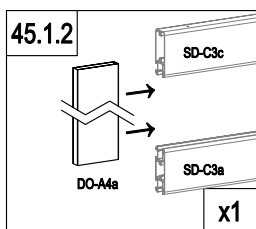
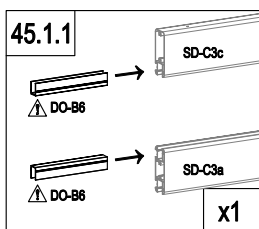
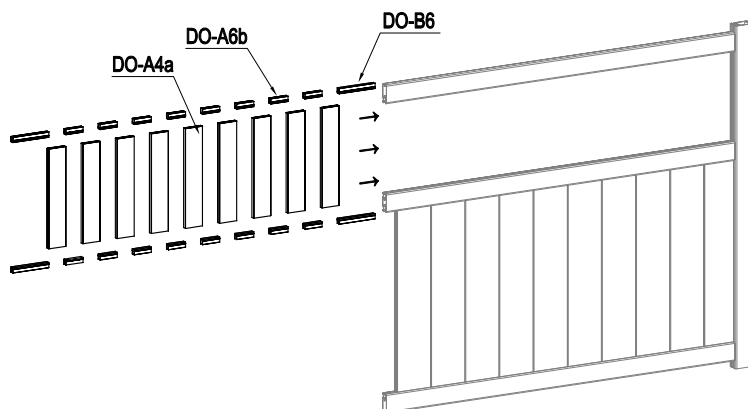

	DO-A4a	9
	DO-B6	4
	DO-A6b	16

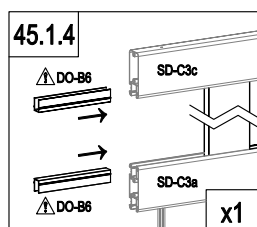

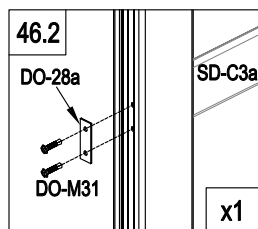
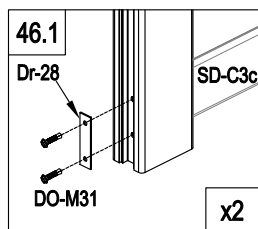
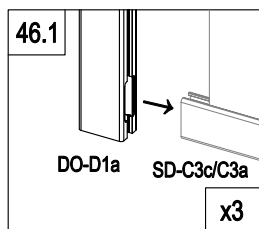
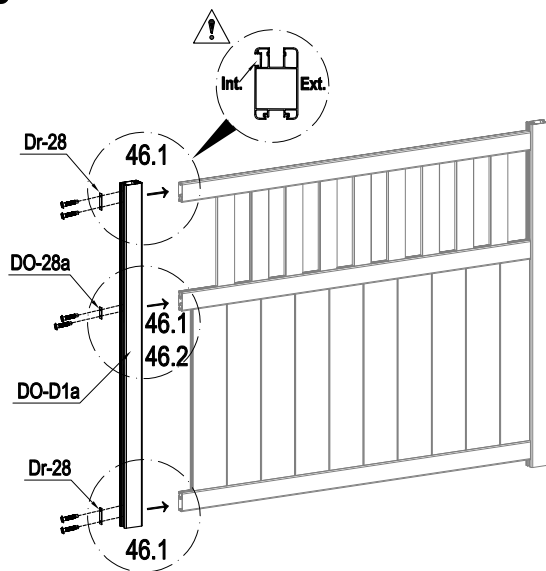
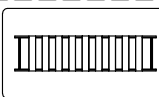

Part C

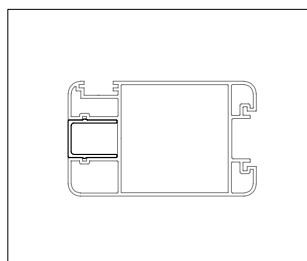
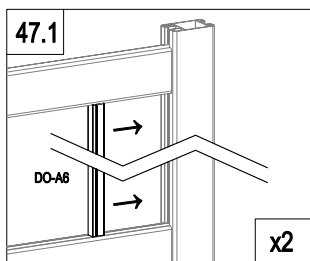
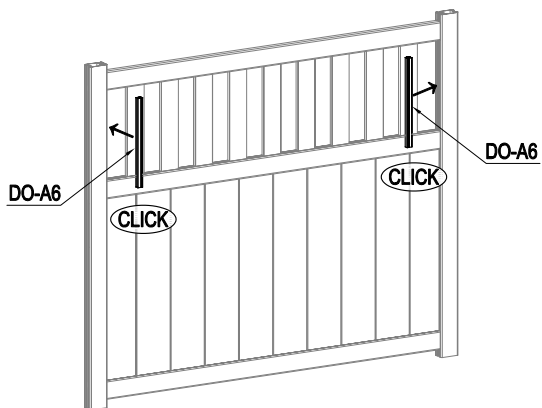
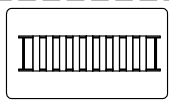

	DO-D1a	1
	Dr-28	2
	DO-28a	1
	DO-M31	6

Part C



	DO-A6	2
---	-------	---

Part C

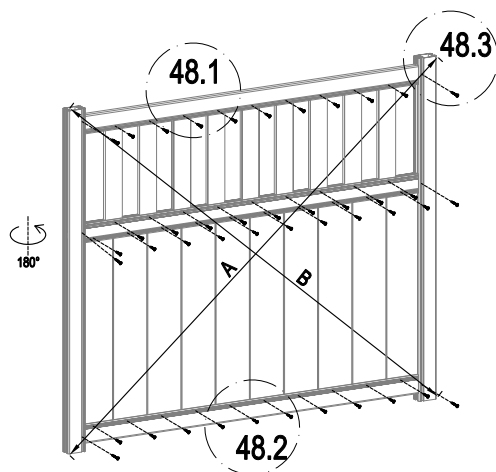
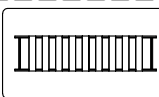

! A=B

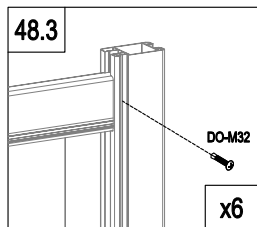
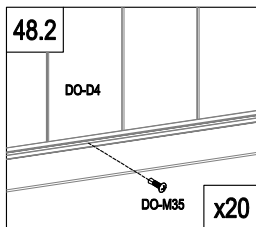
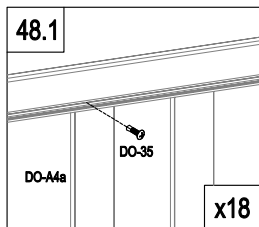

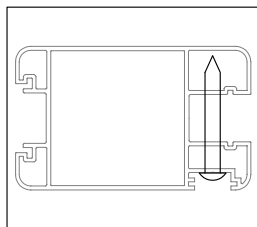
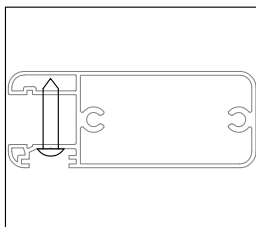

	DO-35	18
	DO-M35	20
	DO-M32	6

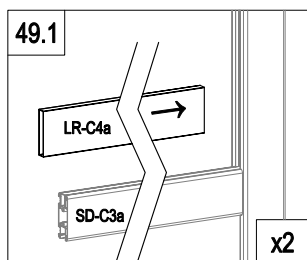
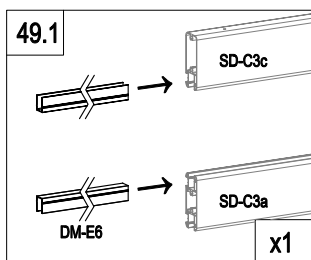
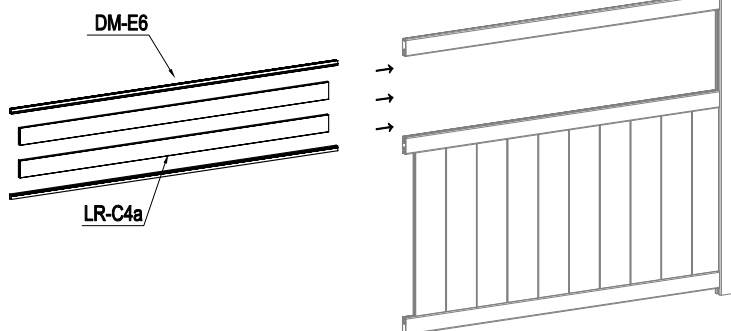
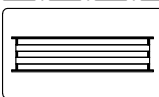

Part C



	LR-C4a	2
	DM-E6	2

Part C

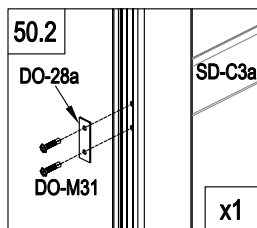
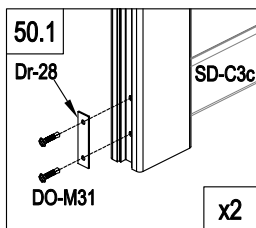
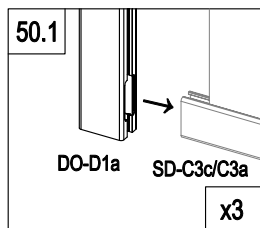
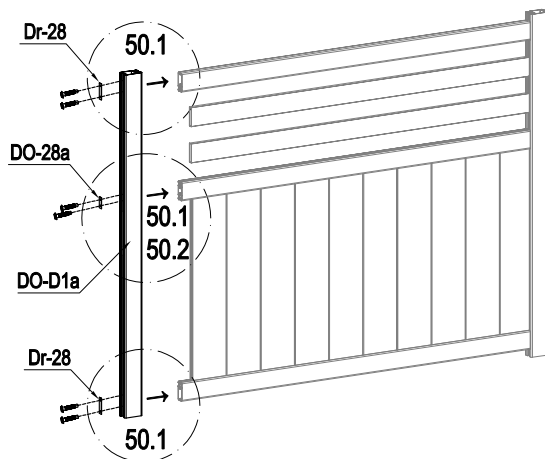
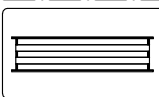

	DO-D1a	1
	Dr-28	2
	DO-28a	1
	DO-M31	6

Part C

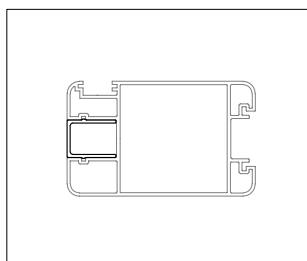
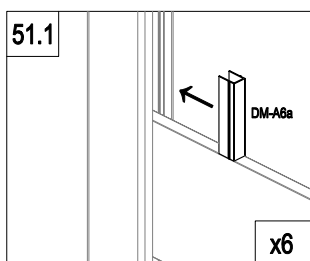
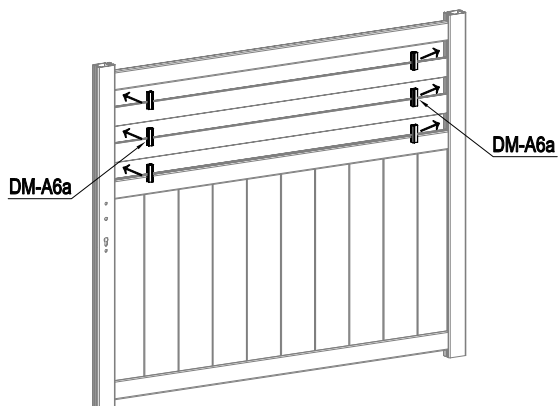
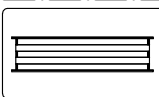



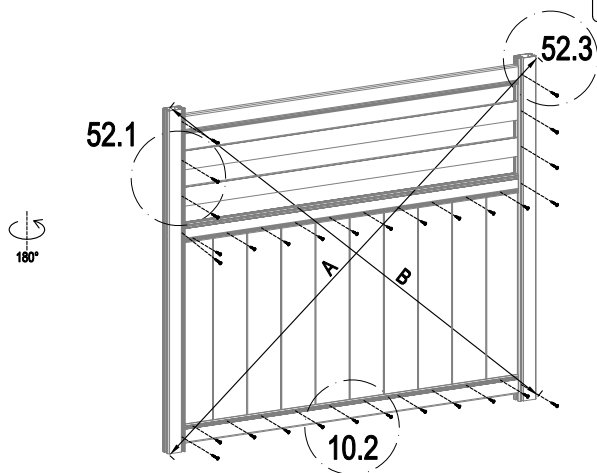

	DM-A6a	6
--	--------	---

Part C

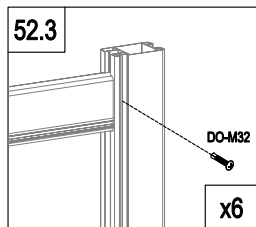
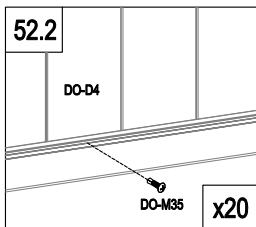
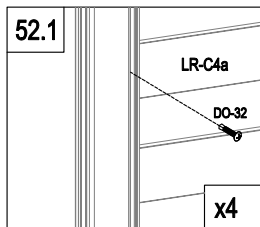

A=B



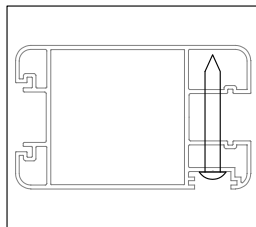
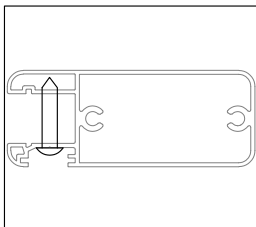

	DO-32	4
	DO-M35	20
	DO-M32	6

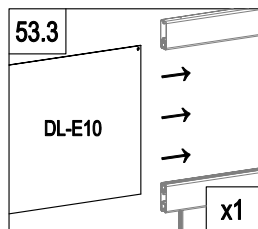
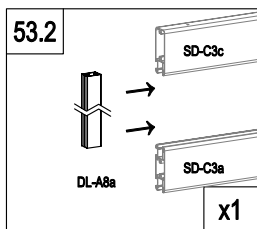
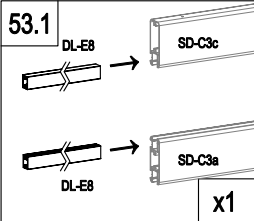
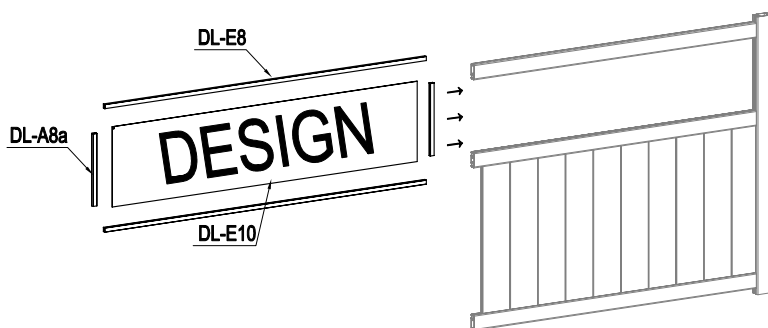

Part C

DESIGN



DESIGN	DL-E10	1
	DL-E8	2
	DL-A8a	2

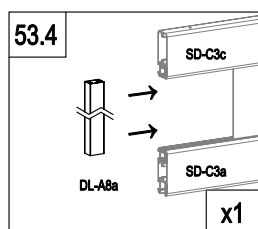

Part C

DESIGN

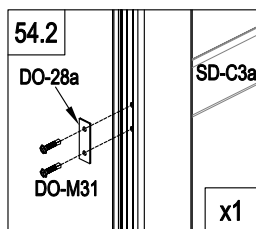
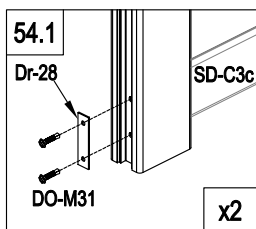
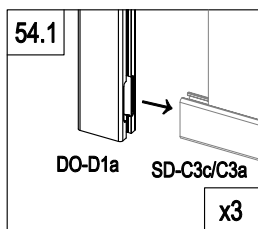
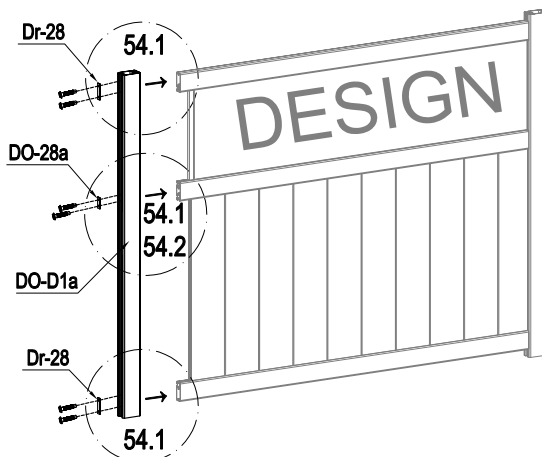

	DO-D1a	1
	Dr-28	2
	DO-28a	1
	DO-M31	6

Part C

DESIGN

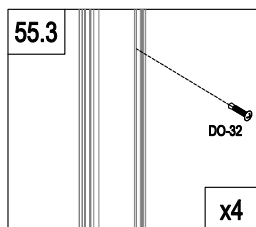
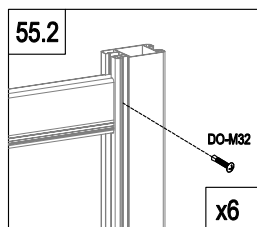
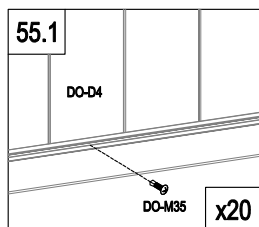
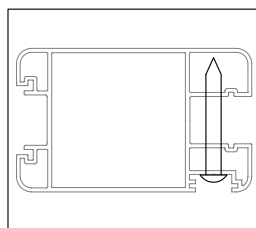
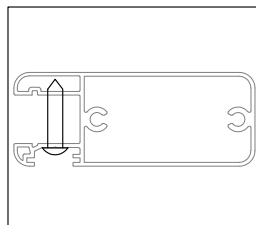
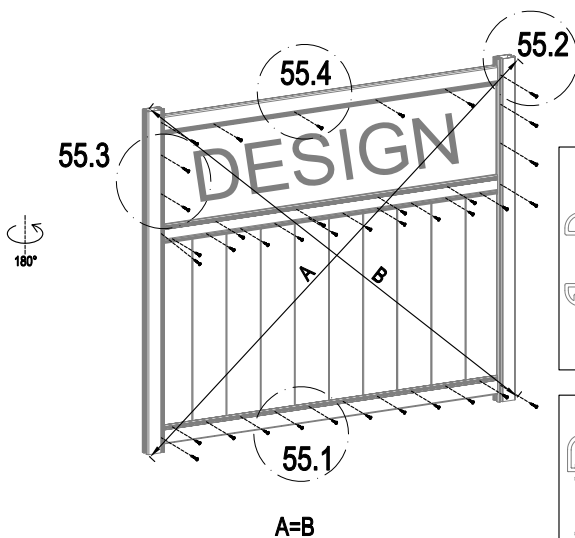

	DO-32	4
	DO-35	8
	DO-M35	20
	DO-M32	6

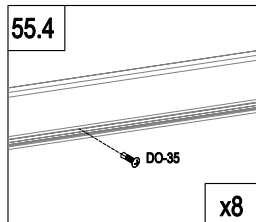

Part C

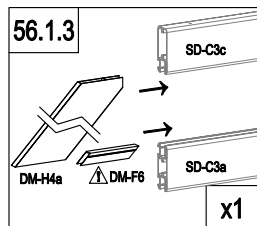
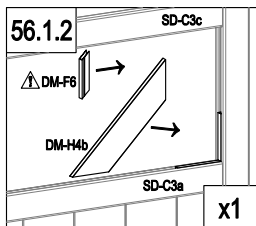
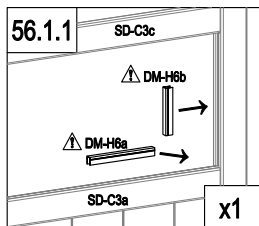
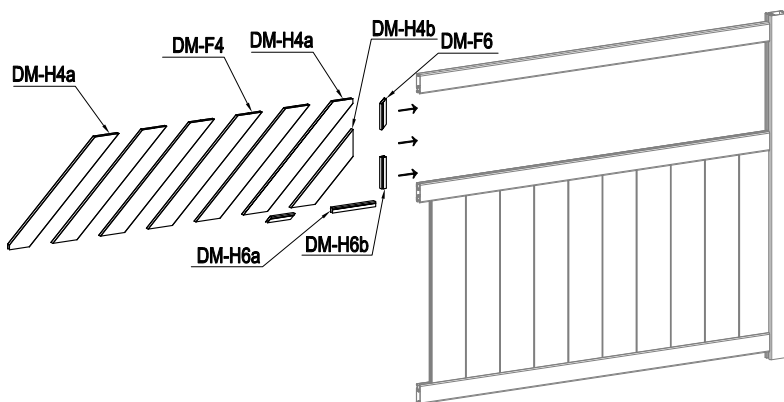
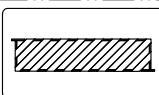

	DM-F4	4
	DM-H4a	2
	DM-H4b	1
	DM-F6	2
	DM-H6a	1
	DM-H6b	1

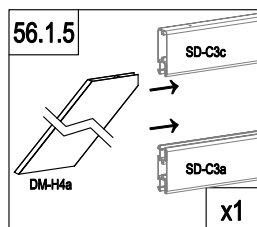
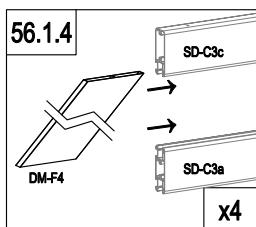

Part C

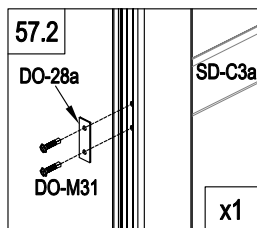
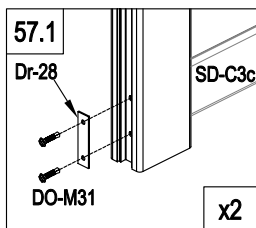
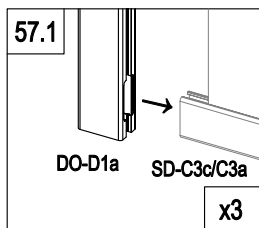
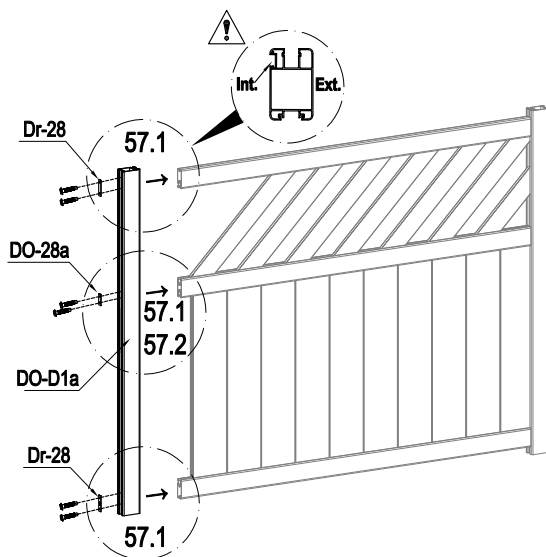
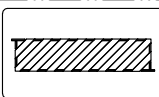

	DO-D1a	1
	Dr-28	2
	DO-28a	1
	DO-M31	6

Part C

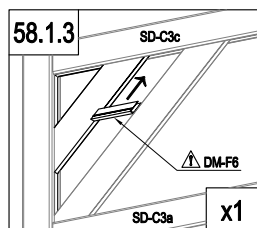
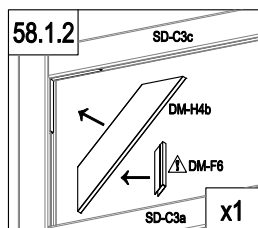
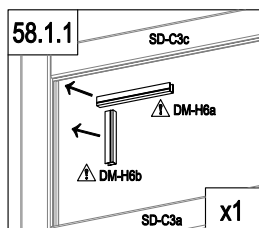
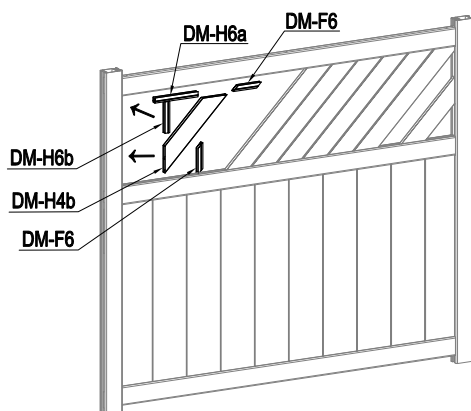
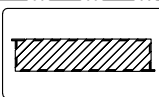

	DM-H4b	1
	DM-F6	2
	DM-H6a	1
	DM-H6b	1

Part C

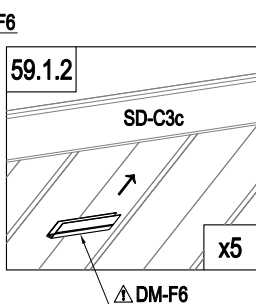
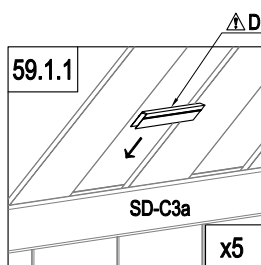
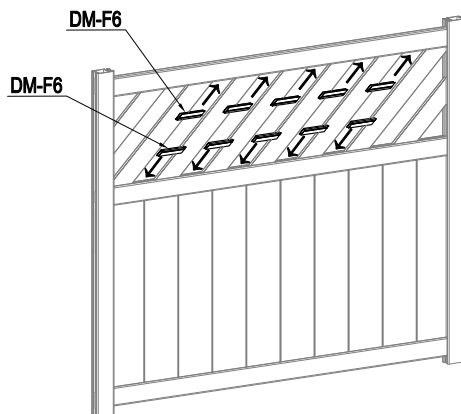
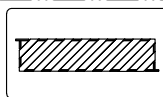

	DM-F6	10
---	-------	----

Part C

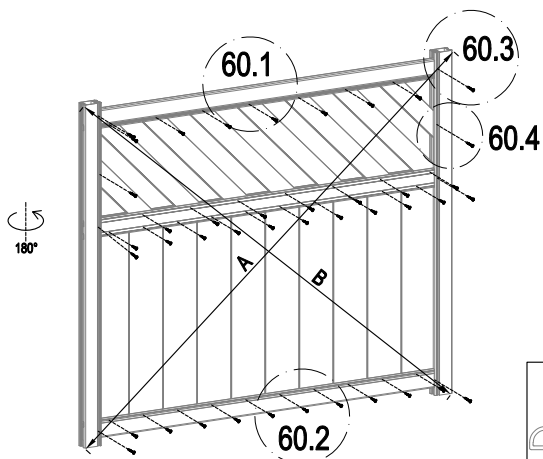
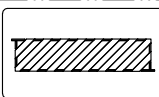

! A=B

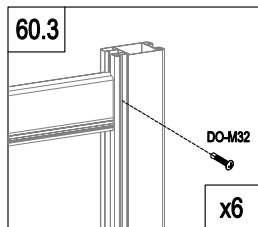
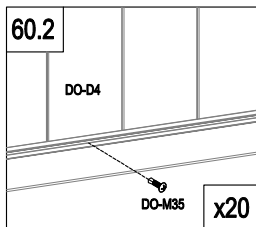
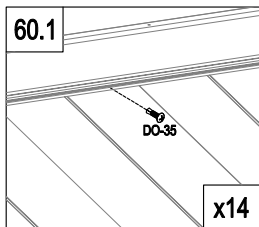
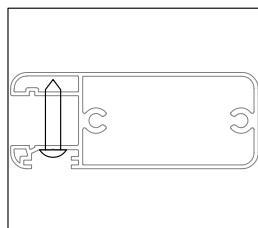

	DO-32	2
	DO-35	14
	DO-M35	20
	DO-M32	6

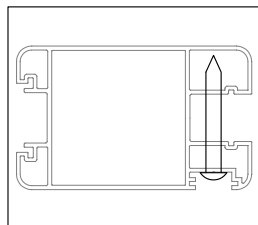
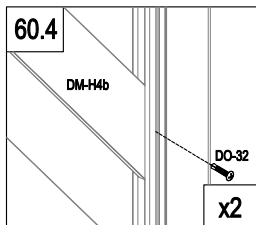

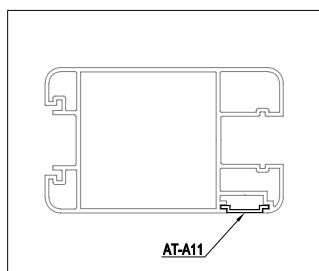
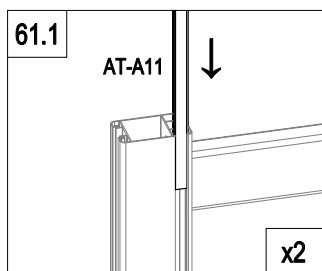
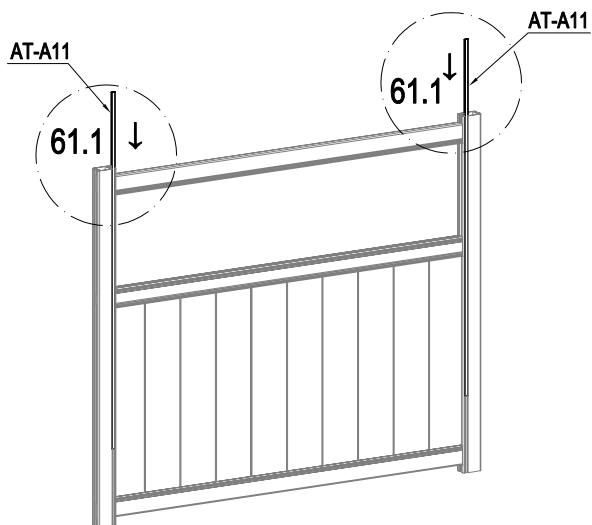

Part C

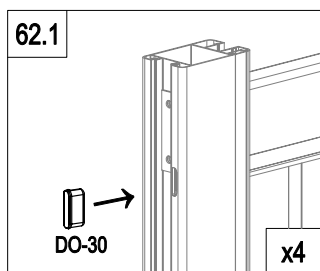
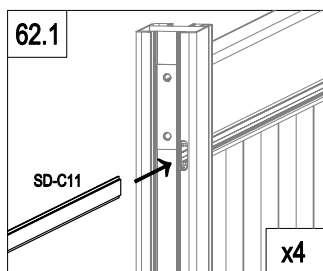
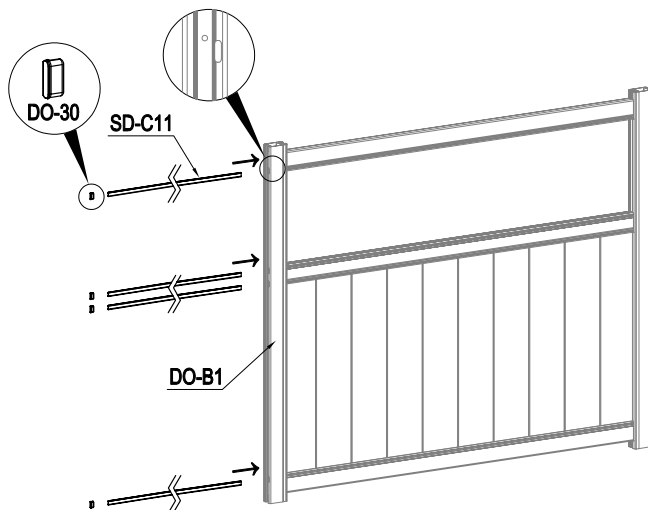

	AT-A11	2
---	--------	---

Part C



	SD-C11	4
	DO-30	4

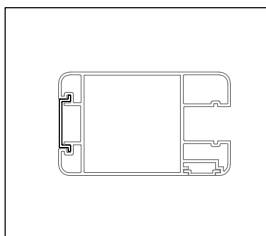
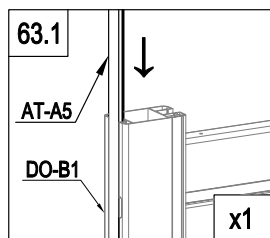
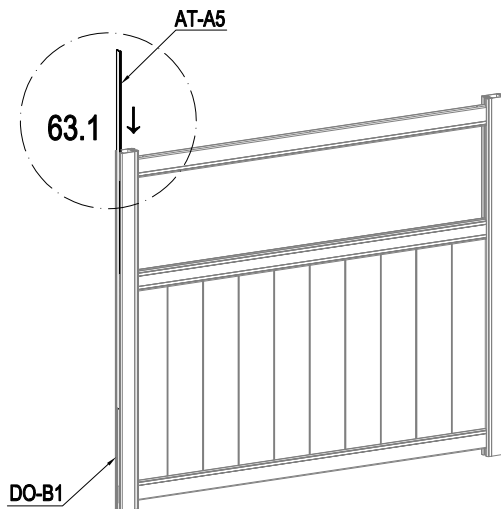

Part C





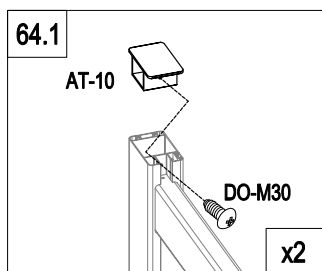
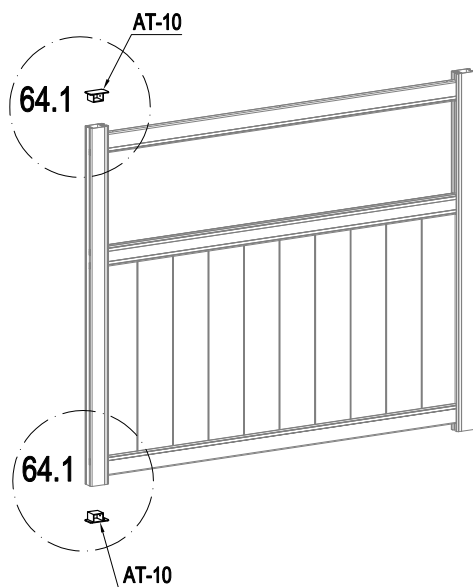

]	AT-A5	1
---	-------	---

Part C

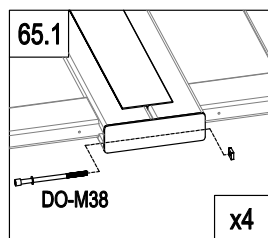
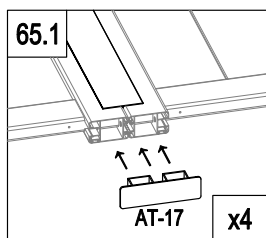
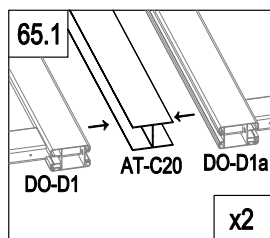
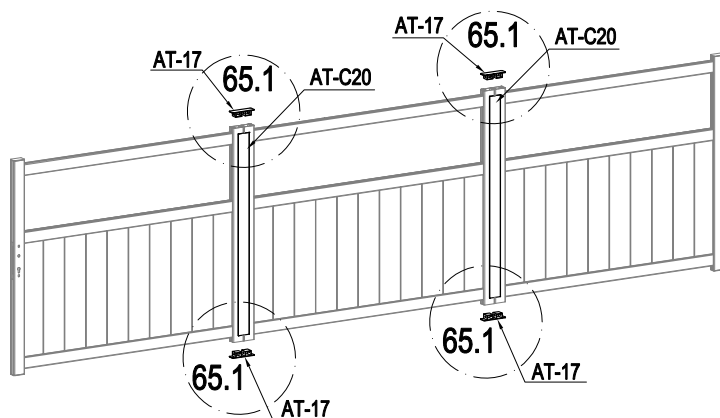



	AT-10	2
	DO-M30	2

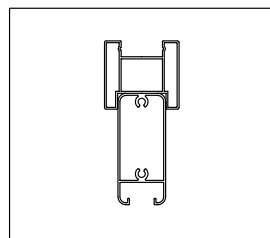
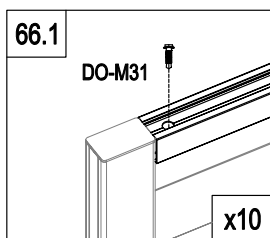
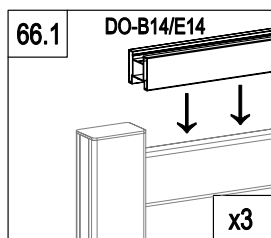
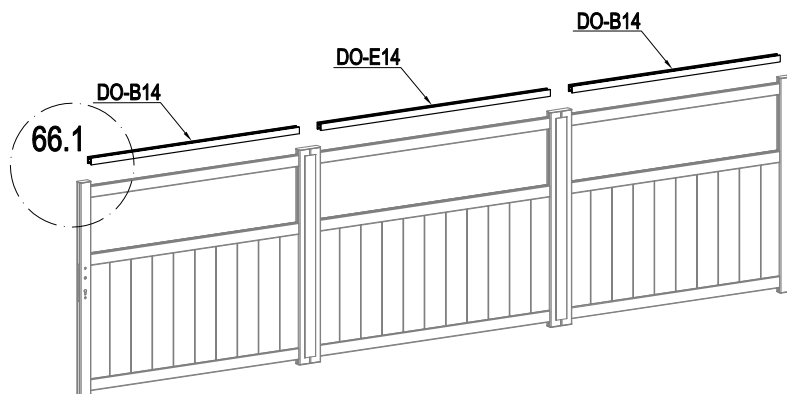

	AT-C20	2
	AT-17	4
	DO-M38	4



	DO-B14	2
	DO-E14	1
	DO-M31	10

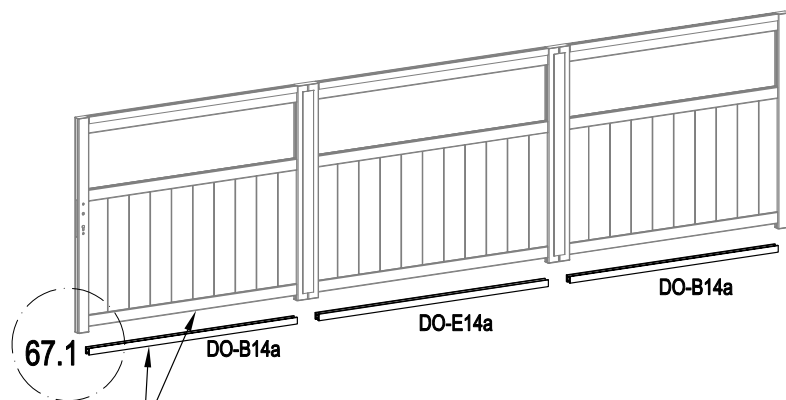



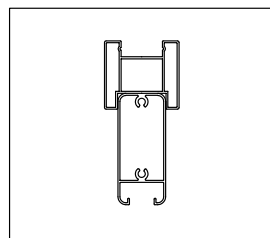
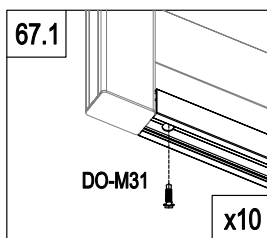
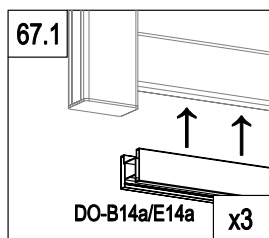

EN: These parts are made for connecting your gate's automation
 FR: Ces pièces sont faites pour relier l'automatisation de votre portail
 DE: Diese Teile sind für den Anschluss der Automatisierung Ihres Tores vorgesehen
 ES: Estas piezas están hechas para conectar la automatización de su puerta
 PT: Estas peças são feitas para ligar a automatização do seu portão
 IT: Queste parti sono realizzate per collegare l'automazione del vostro cancello
 NL: Deze onderdelen zijn gemaakt voor het aansluiten van de automatisering van uw poort.
 PL: Te części są wykonane do podłączenia automatyki bramy.

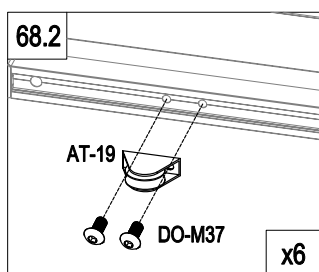
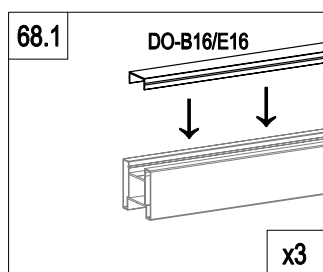
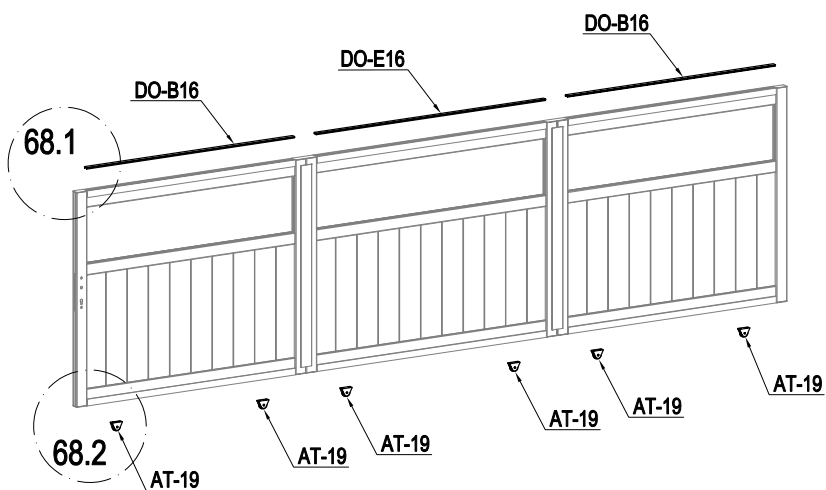



	DO-B14a	2
	DO-E14a	1
	DO-M31	10

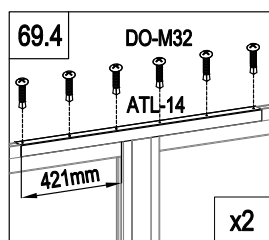
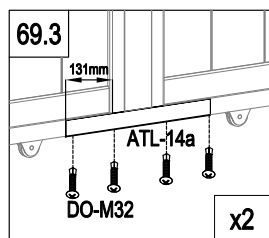
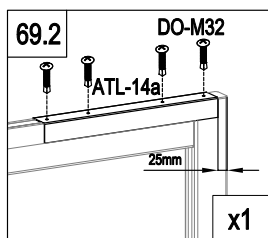
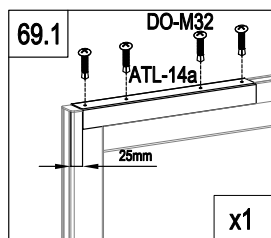
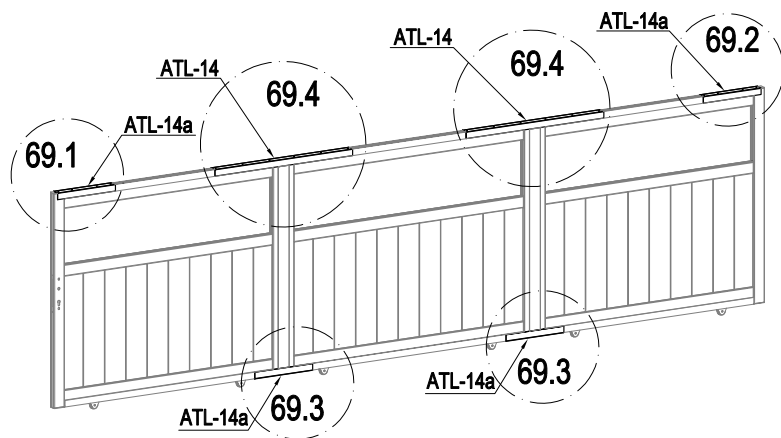

	DO-B16	2
	DO-E16	1
	AT-19	6
	DO-M37	12



	ATL-14	2
	ATL-14a	4
	DO-M32	28

Ext.

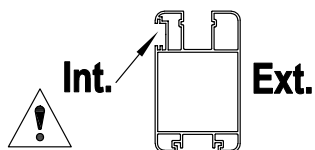
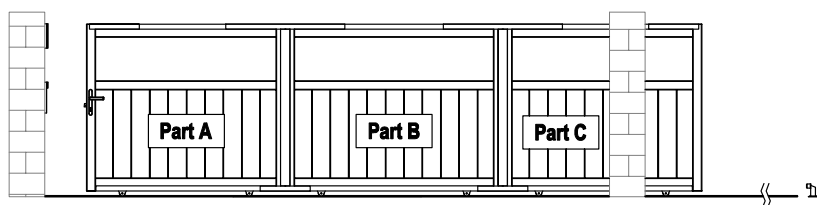

Int.

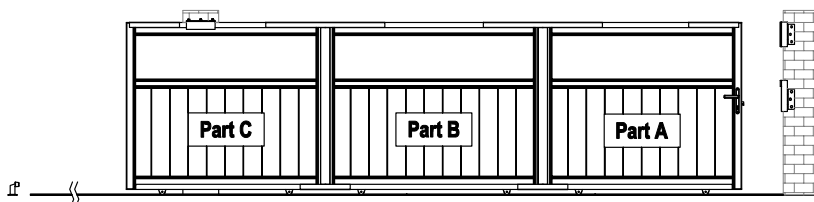

L : P86~92

Ext.

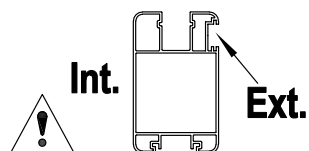
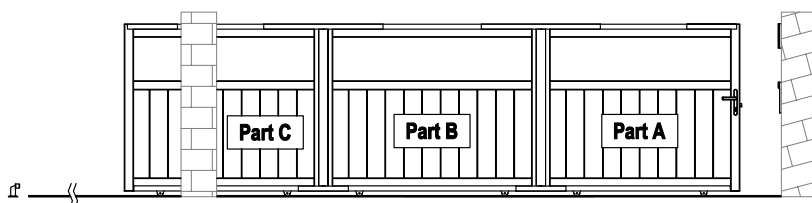

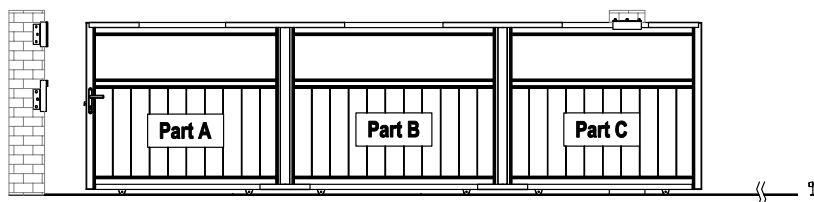

Int.

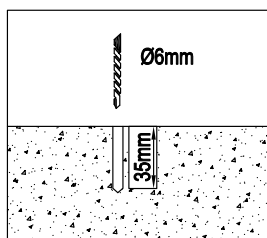
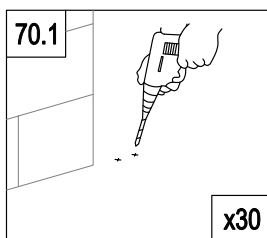
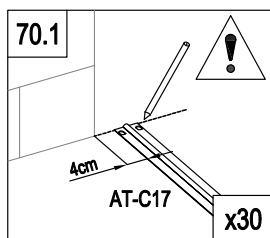
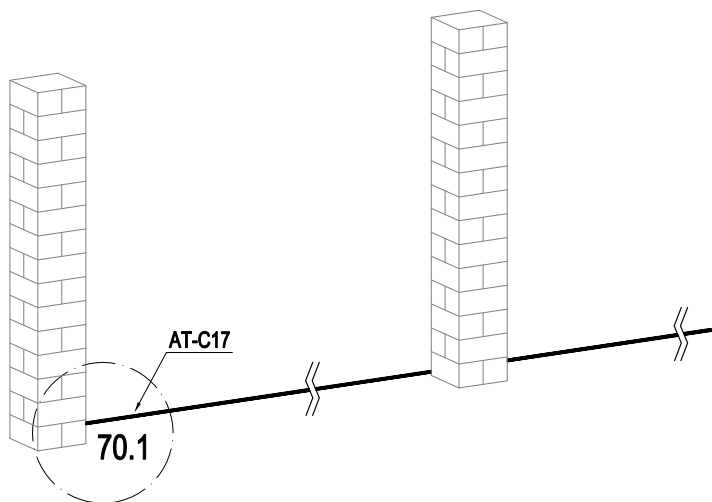

R : P93~99

L



	AT-C17	6
	DO-M34	60

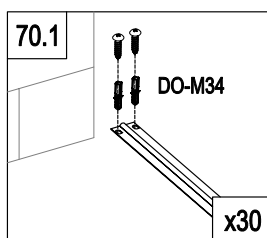

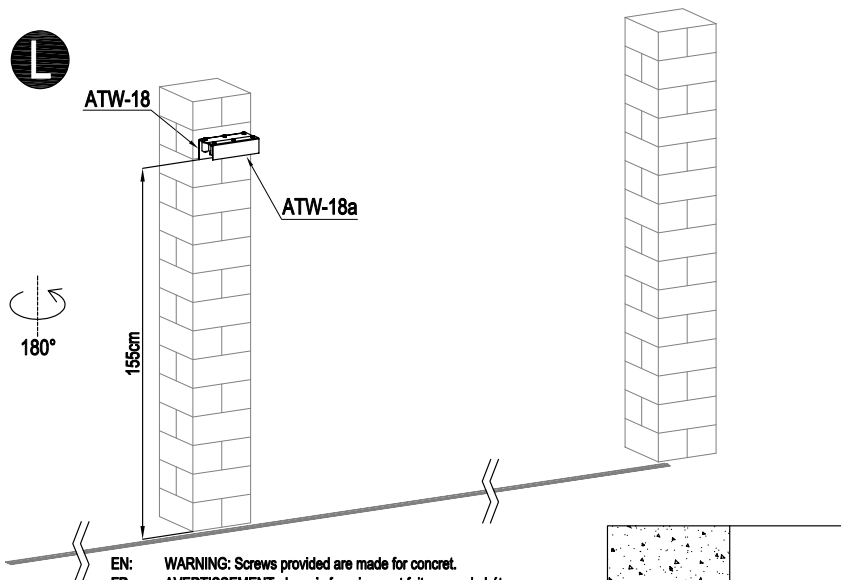

EN: WARNING: Screws provided are made for concret.
 FR: AVERTISSEMENT : Les vis fournies sont faites pour le béton.
 DE: WARNUNG: Die mitgelieferten Schrauben sind für Beton ausgelegt.
 ES: ADVERTENCIA: Los tornillos suministrados están hechos para el hormigón.
 IT: ATTENZIONE: Le viti fornite sono fatte per il calcestruzzo.
 NL: WAARSCHUWING: De bijgeleverde schroeven zijn gemaakt voor beton.
 PL: OSTRZEŻENIE: Dostarczone śruby są przeznaczone do betonu.
 PT: AVISO: Os parafusos fornecidos são feitos para betão.

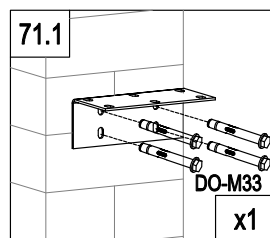
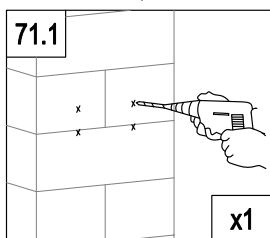
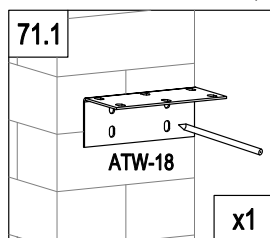
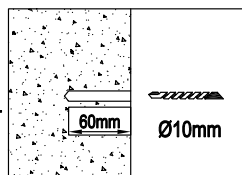

	ATW-18	1
	ATW-18a	1
	AT-20	6
	DO-M33	4

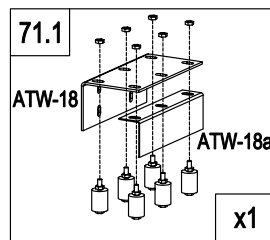
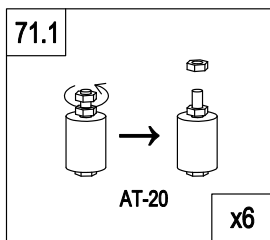

L

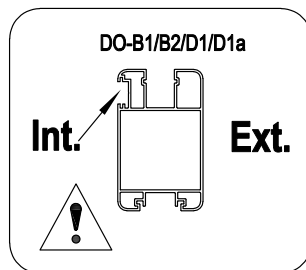
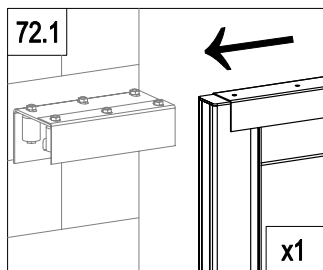
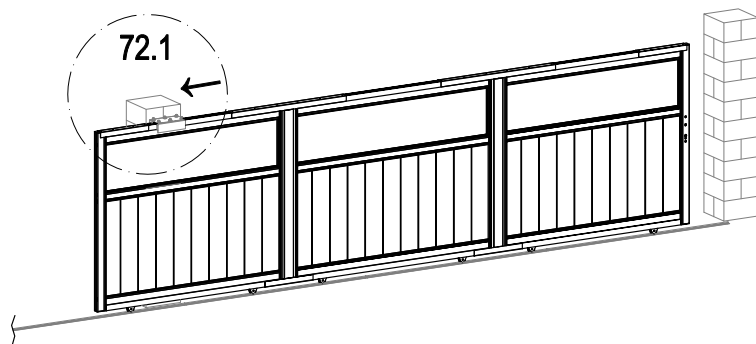

L

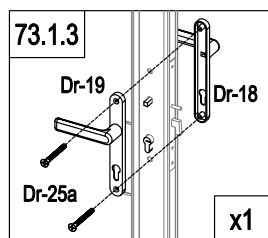
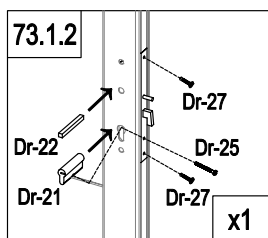
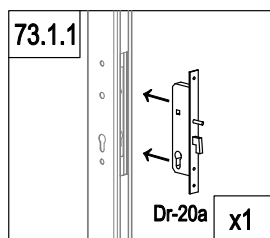
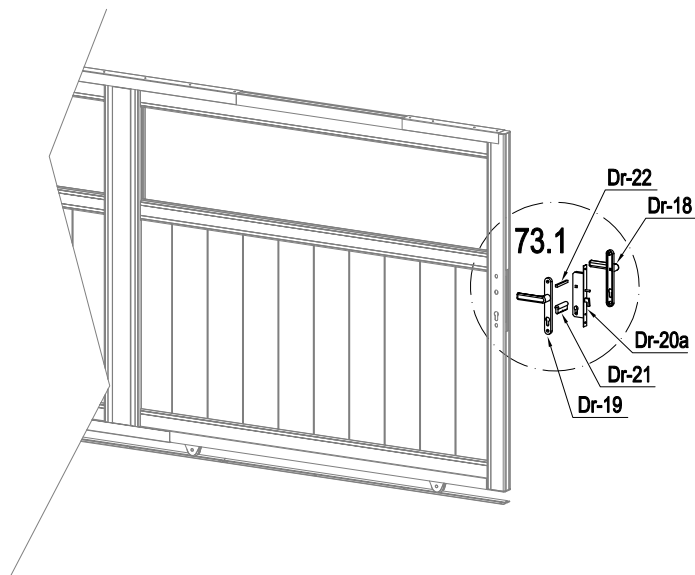

	Dr-20a	1
	Dr-21	1
	Dr-22	1
	Dr-25	1

	Dr-18	1
	Dr-19	1
	Dr-25a	2
	Dr-27	2



EN: WARNING: Screws provided are made for concret.
 FR: AVERTISSEMENT : Les vis fournies sont faites pour le béton.
 DE: WARNUNG: Die mitgelieferten Schrauben sind für Beton ausgelegt.
 ES: ADVERTENCIA: Los tornillos suministrados están hechos para el hormigón.
 IT: ATTENZIONE: Le viti fornite sono fatte per il calcestruzzo.
 NL: WAARSCHUWING: De bijgeleverde schroeven zijn gemaakt voor beton.
 PL: OSTRZEŻENIE: Dostarczone śruby są przeznaczone do betonu.
 PT: AVISO: Os parafusos fornecidos são feitos para betão.

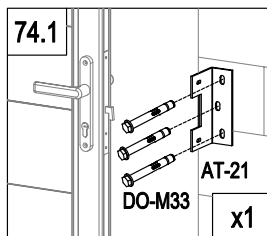
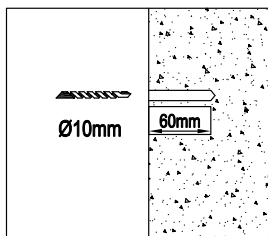
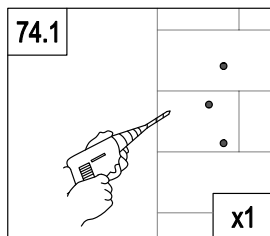
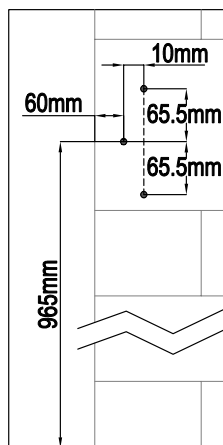
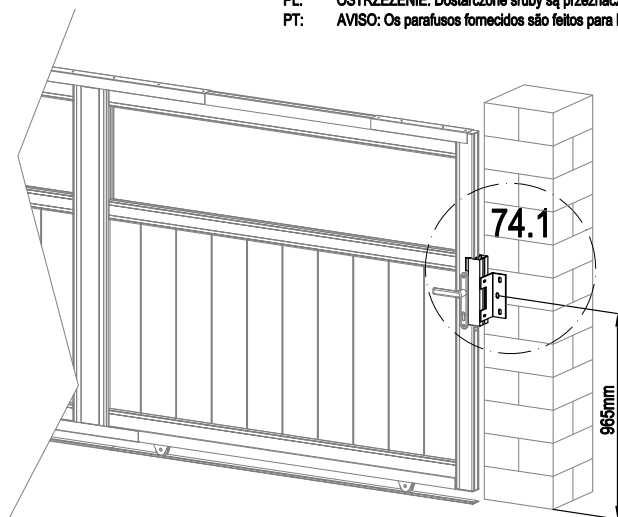

	AT-16	1
	AT-21	1
	DO-M36	2
	DO-M33	3
	AT-22J	3

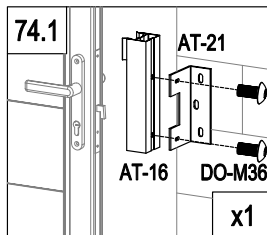
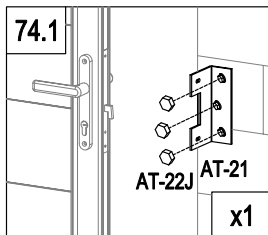

L

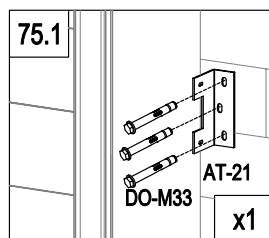
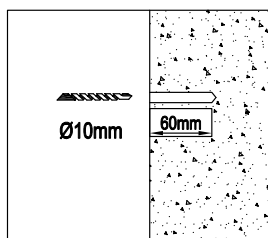
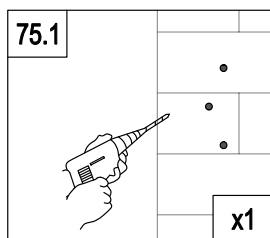
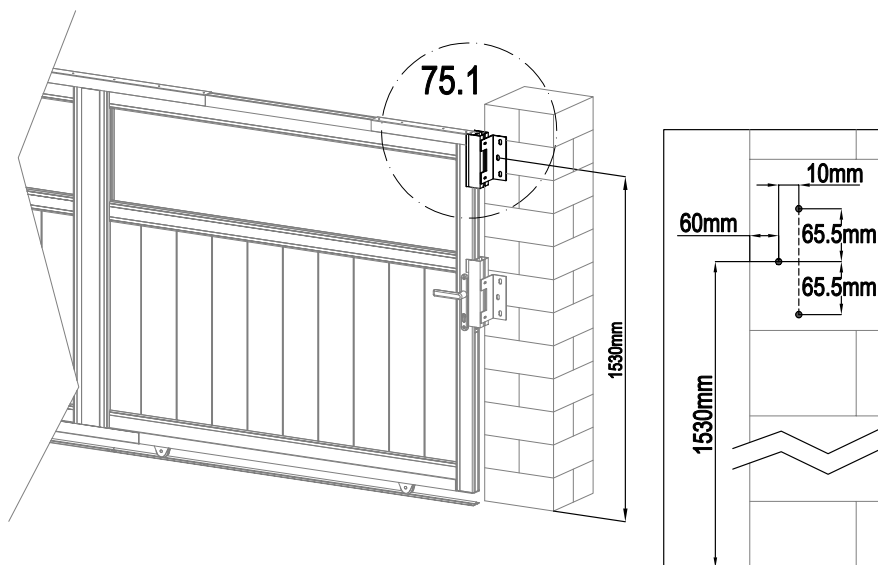

	AT-16a	1
	AT-21	1
	DO-M36	2
	DO-M33	3
	AT-22J	3

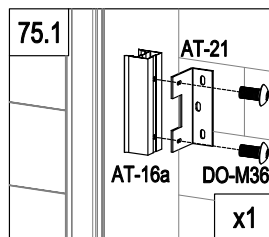
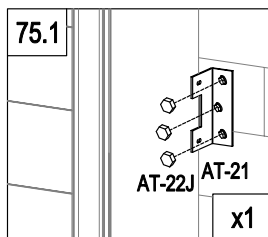

L

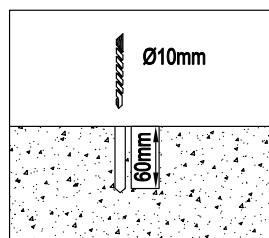
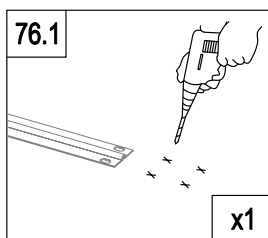
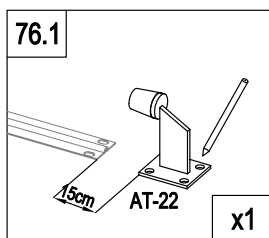
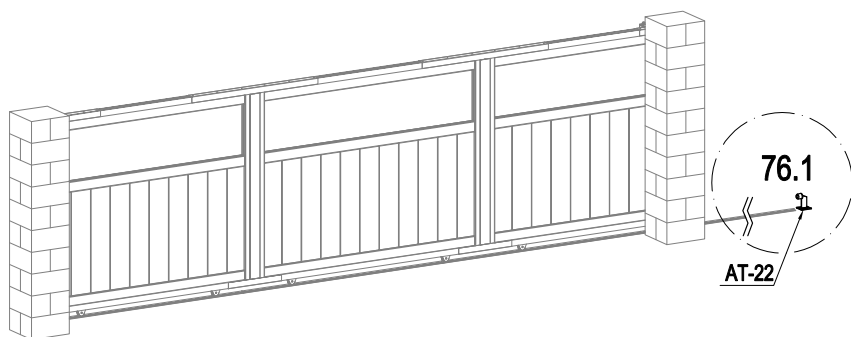

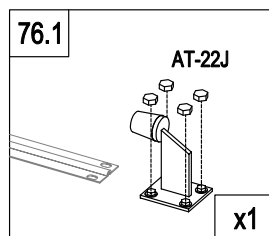
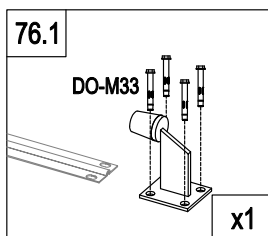

	AT-22	1
	DO-M33	4
	AT-22J	4

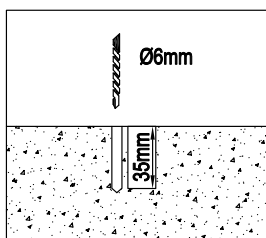
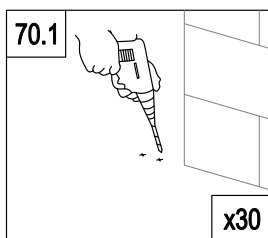
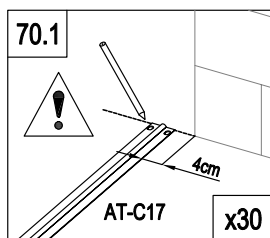
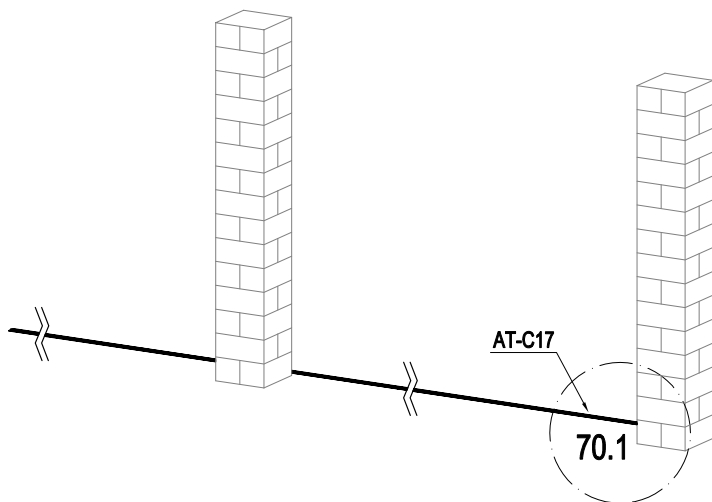

R



	AT-C17	6
	DO-M34	60

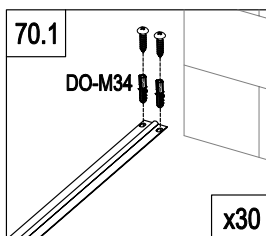

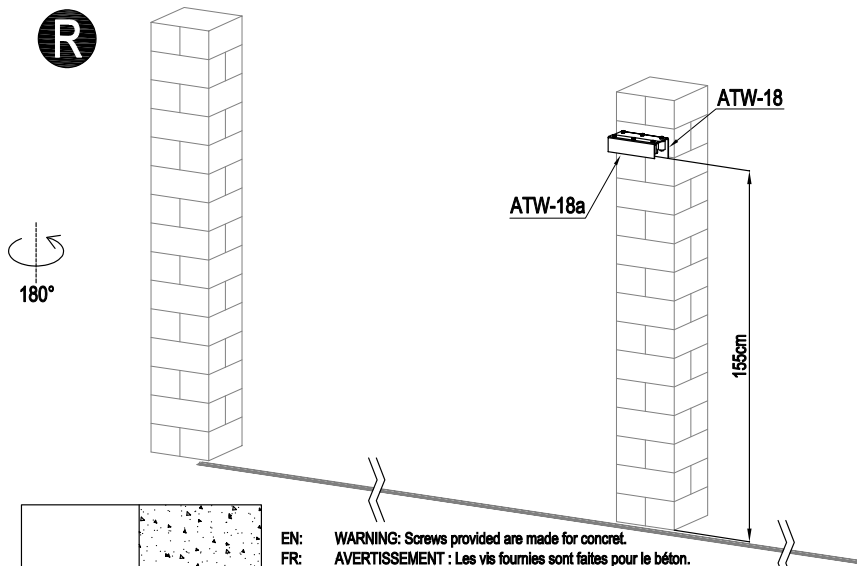

EN: WARNING: Screws provided are made for concrete.
 FR: AVERTISSEMENT : Les vis fournies sont faites pour le béton.
 DE: WARNUNG: Die mitgelieferten Schrauben sind für Beton ausgelegt.
 ES: ADVERTENCIA: Los tornillos suministrados están hechos para el hormigón.
 IT: ATTENZIONE: Le viti fornite sono fatte per il calcestruzzo.
 NL: WAARSCHUWING: De bijgeleverde schroeven zijn gemaakt voor beton.
 PL: OSTRZEŻENIE: Dostarczone śruby są przeznaczone do betonu.
 PT: AVISO: Os parafusos fornecidos são feitos para betão.

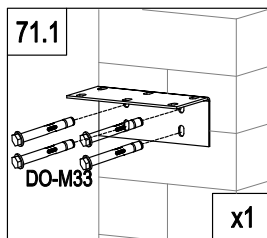
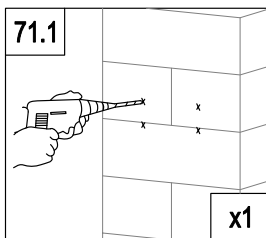
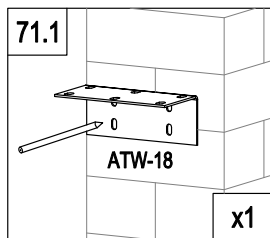

	ATW-18	1
	ATW-18a	1
	AT-20	6
	DO-M33	4

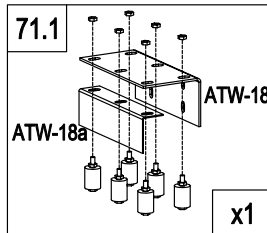
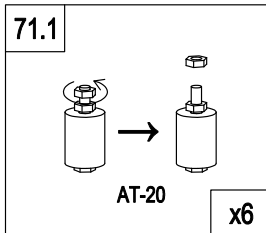

R

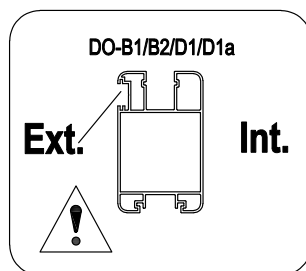
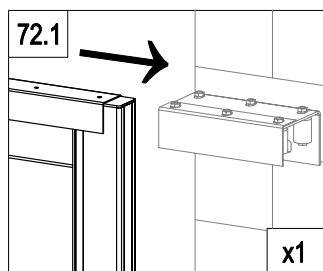
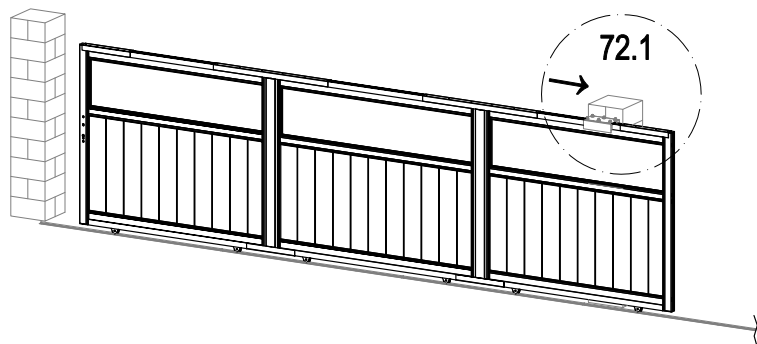

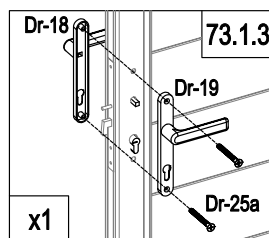
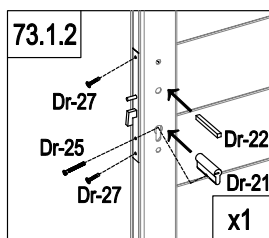
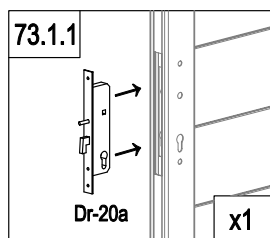
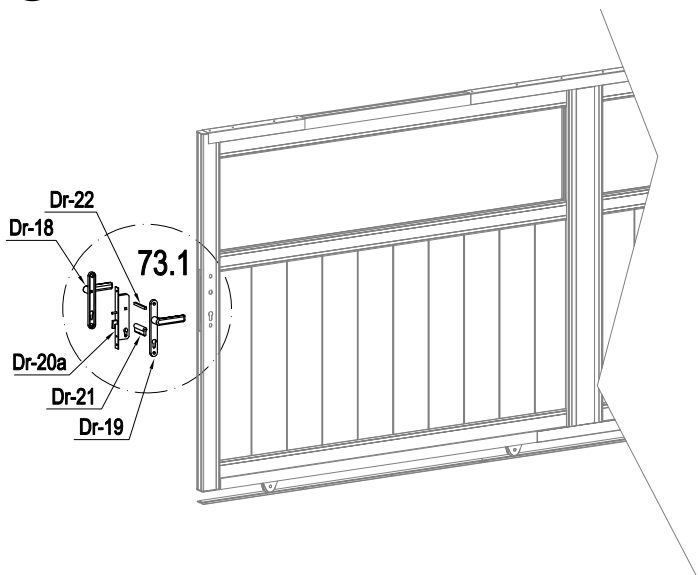

	Dr-20a	1
	Dr-21	1
	Dr-22	1
	Dr-25	1

	Dr-18	1
	Dr-19	1
	Dr-25a	2
	Dr-27	2



EN: WARNING: Screws provided are made for concrete.
 FR: AVERTISSEMENT : Les vis fournies sont faites pour le béton.
 DE: WARNUNG: Die mitgelieferten Schrauben sind für Beton ausgelegt.
 ES: ADVERTENCIA: Los tornillos suministrados están hechos para el hormigón.
 IT: ATTENZIONE: Le viti fornite sono fatte per il calcestruzzo.
 NL: WAARSCHUWING: De bijgeleverde schroeven zijn gemaakt voor beton.
 PL: OSTRZEŻENIE: Dostarczone śruby są przeznaczone do betonu.
 PT: AVISO: Os parafusos fornecidos são feitos para betão.

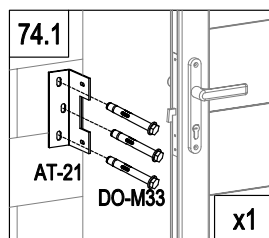
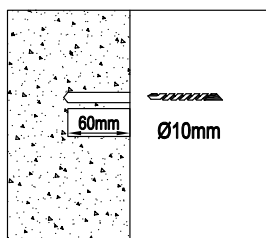
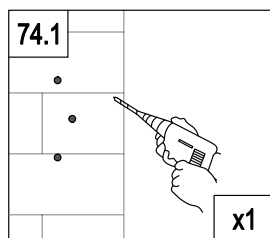
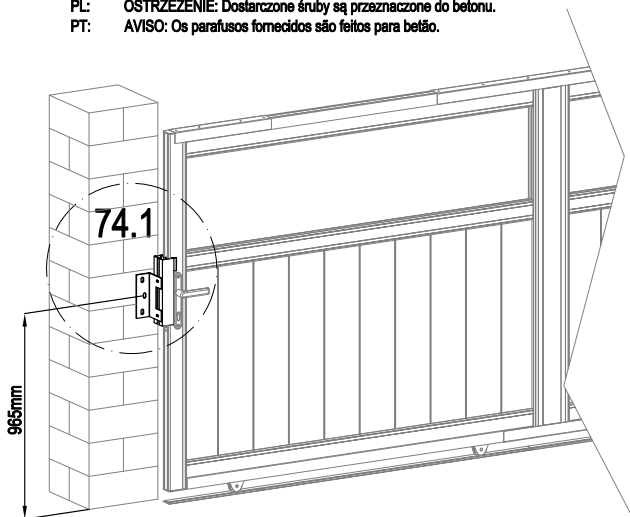
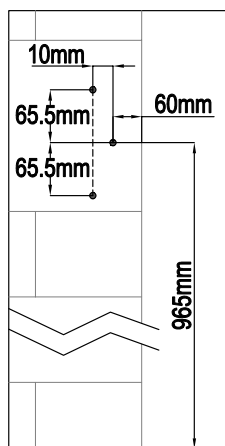

	AT-16	1
	AT-21	1
	DO-M36	2
	DO-M33	3
	AT-22J	3

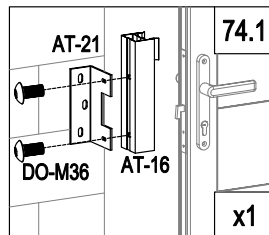
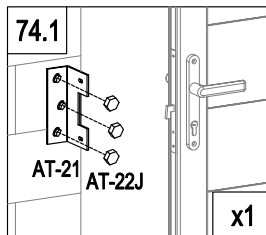

R

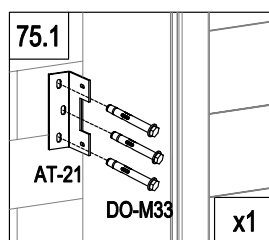
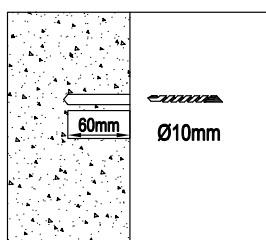
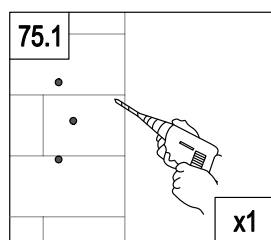
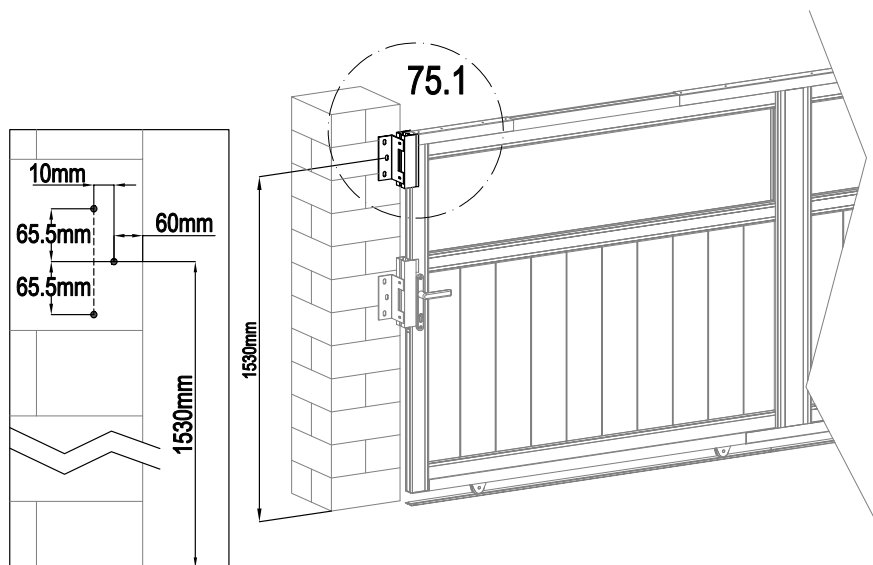

	AT-16a	1
	AT-21	1
	DO-M36	2
	DO-M33	3
	AT-22J	3

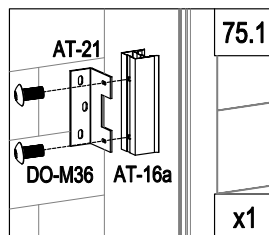
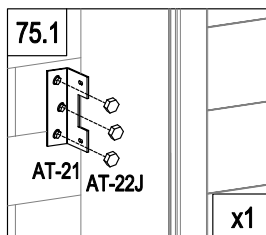

R

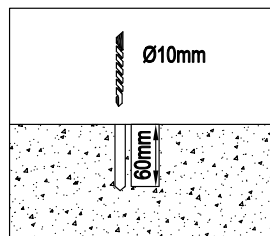
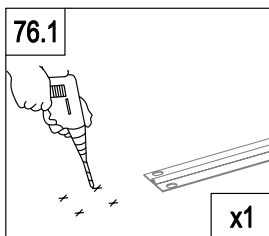
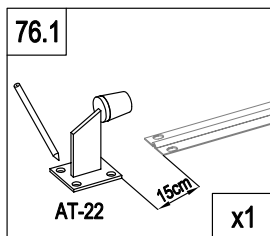
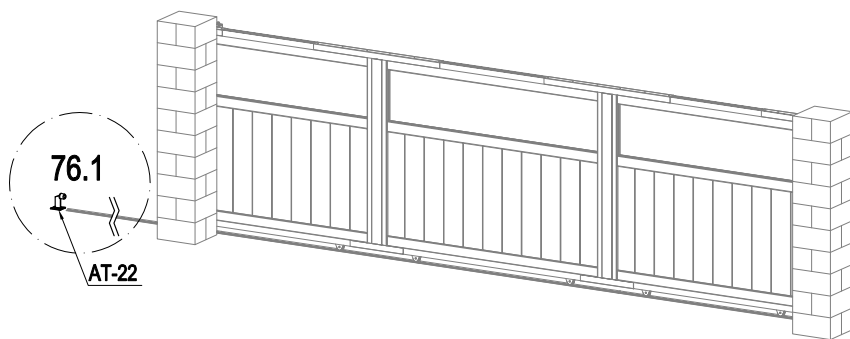

	AT-22	1
	DO-M33	4
	AT-22J	4

