

CASANOVO

Do 400C140

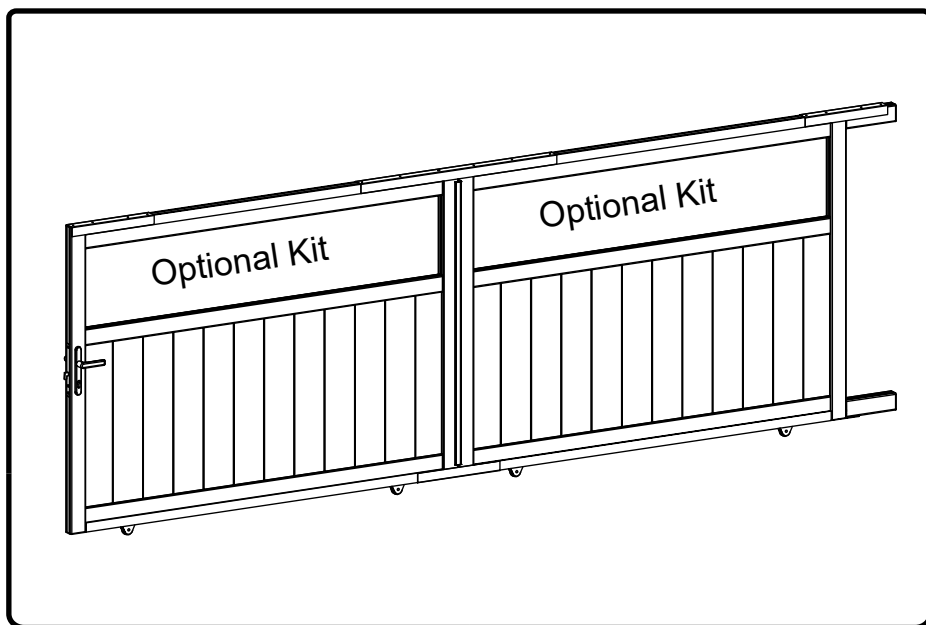

INSTRUCTION MANUAL / NOTICE DE MONTAGE / MONTAGEANLEITUNG / MANUAL DE MONTAJE / MANUAL DE MONTAGEM / MANUALE DI MONTAGGIO /
MONTAGEHANDLEIDING / INSTRUKCJA MONTAŻU / KÄYTTÖOHJEET / BRUKSANVISNING / BRUGSANVISNING / INSTRUCIUNI DE ASAMBLARE /
NAVODILA ZA SESTAVLJANJE / NÁVOD NA MONTÁŽ / ÖSSZESZERELÉSI ÚTMUTATÓ / NÁVOD K MONTÁŽI / UPUTE ZA INSTALACIJU /
ΟΔΗΓΙΕΣ ΣΥΝΑΡΜΟΛΟΓΗΣΗΣ / SURINKIMO INSTRUKCIJOS / MONTĀŽAS INSTRUKCIJAS

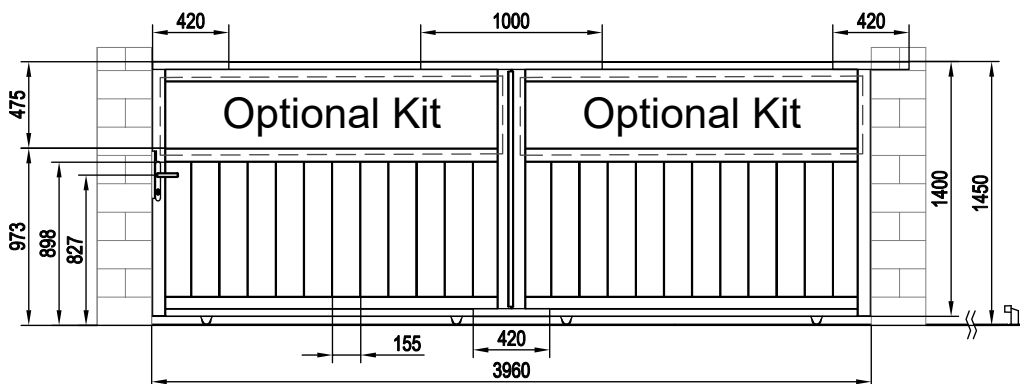

Int.

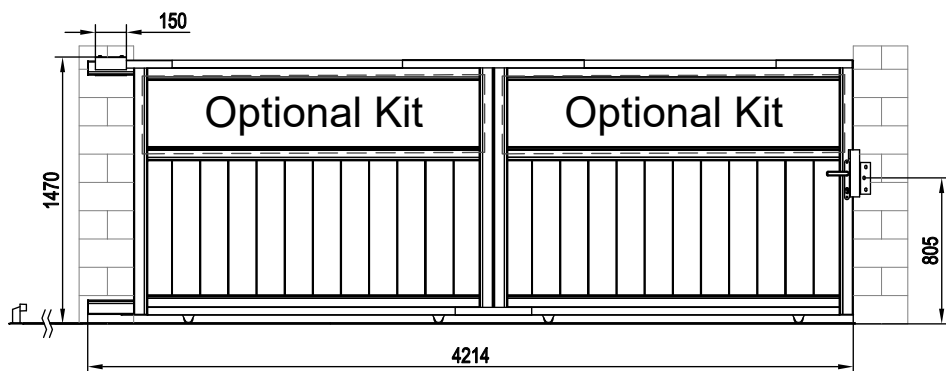

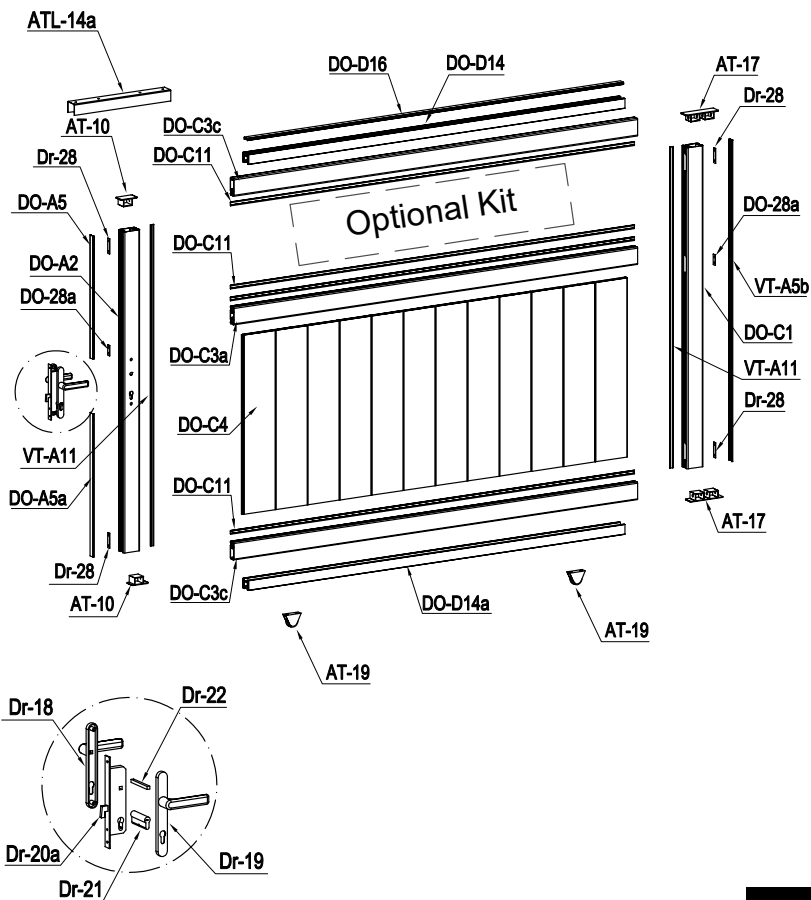
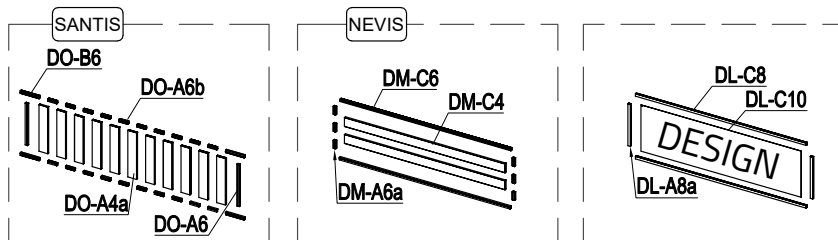

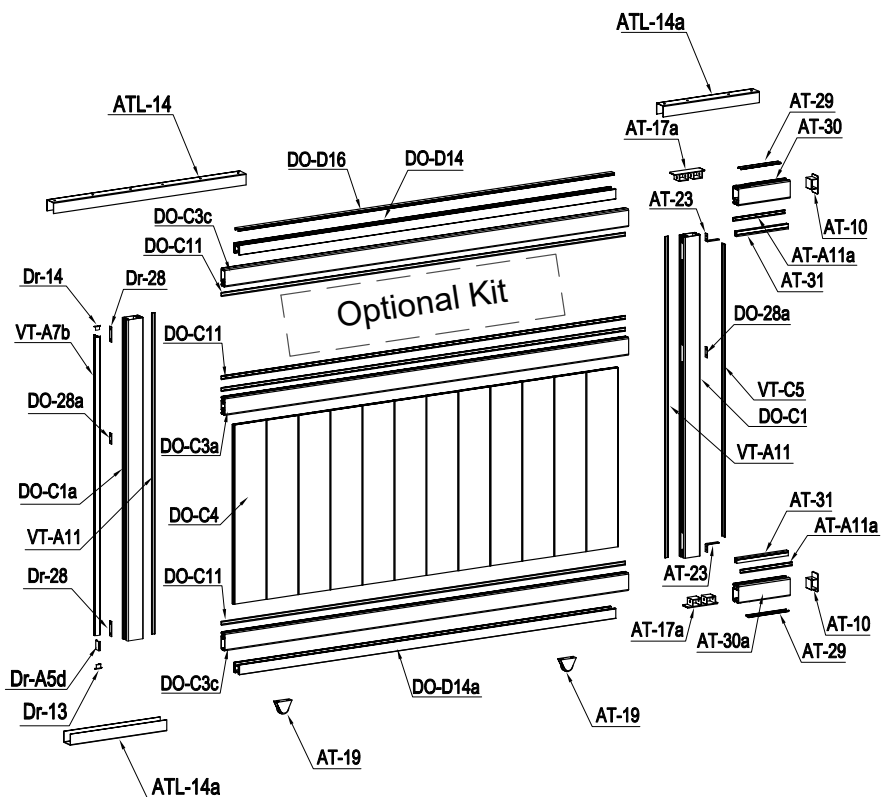
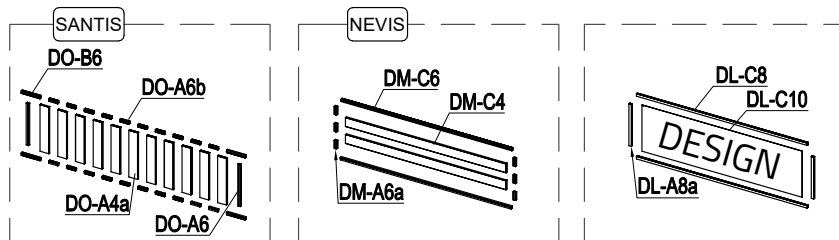

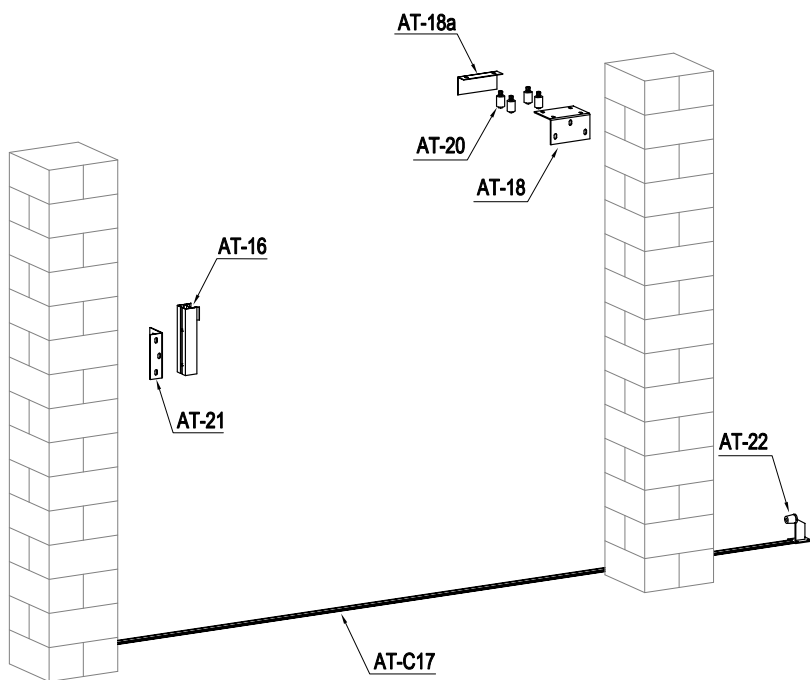













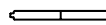















































PARTS LIST

IMAGE	NO.	L.(mm)	QTY	IMAGE	NO.	L.(mm)	QTY
	DO-C1	1395	2		AT-18		1
	DO-C1a	1395	1		AT-18a		1
	DO-A2	1395	1		ATL-14	1000	1
	AT-30	250	1		ATL-14a	420	3
	AT-30a	250	1		AT-19		4
	DO-C3c	1957	4		AT-20		4
	DO-C3a	1957	2		AT-21		1
	DO-C4	779	24		AT-22		1
	VT-A5b	1395	1		AT-23		2
	VT-C5	1270	1		Dr-18		1
	DO-A5	532.5	1		Dr-19		1
	DO-A5a	622	1		Dr-20a		1
	AT-29	193	2		Dr-21		1
	Dr-A5d	52	1		Dr-22		1
	VT-A11	1395	4		Dr-25		1
	AT-A11a	250	2		Dr-25a		2
	DO-C11	1957	8		Dr-27		2
	AT-31	250	2		Dr-28		6
	VT-A7b	1290	1		DO-28a		4
	DO-D14	1823	2		AT-22J		7
	DO-D14a	1823	2		DO-H30	ST4x10	4
	DO-D16	1822	2		DO-H31	ST5.5x38	40
	AT-16		1		DO-H32	ST4.8x38	38
	AT-C17	1580	5		DO-H33	M8x60	10
	AT-17		2		DO-H34	ST4x25	50
	AT-17a		2		DO-H35	ST4.2x19	54
	AT-10		4		DO-H36	M6x20	2
	Dr-13		1		DO-H37	M8x20	8
	Dr-14		1		DO-H38	M8x130	4
	DO-30		8				

PARTS LIST (Optional Kit)

	IMAGE	NO.	L.(mm)	QTY
		DO-A4a	406	22
		DO-A6	364	4
		DO-B6	163	8
		DO-A6b	77.5	40
		DO-35		44

	IMAGE	NO.	L.(mm)	QTY
		DM-C4	1865	4
		DM-C6	1955	4
		DM-A6a	69	12
		DO-32		8

	IMAGE	NO.	L.(mm)	QTY
		DL-C8	1955	4
		DL-A8a	364	4
		DL-C10	1862	2
		DO-32		8
		DO-35		24

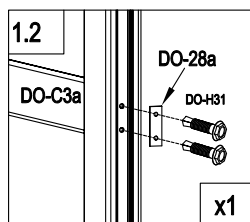
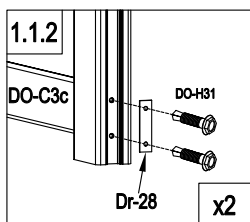
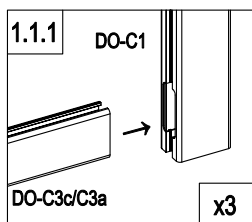
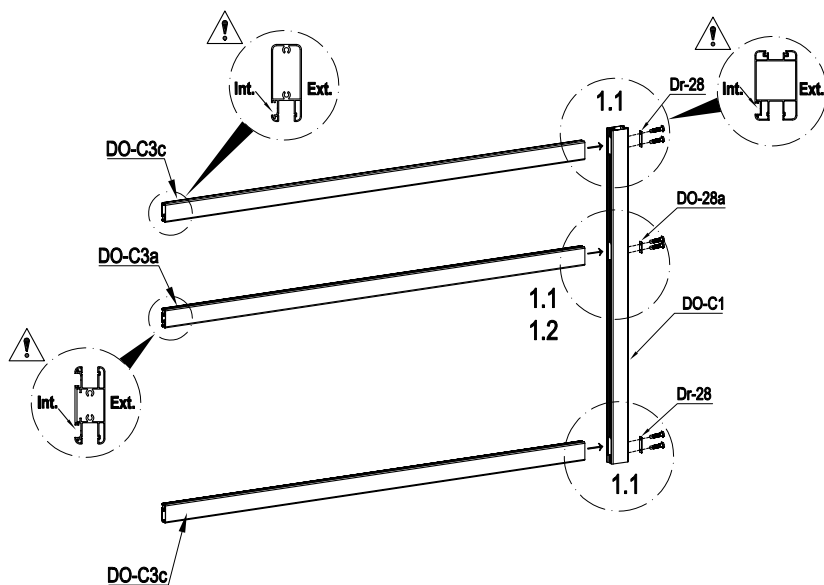

	DO-C1	1
	DO-C3c	2
	DO-C3a	1

	Dr-28	2
	DO-28a	1
	DO-H31	6

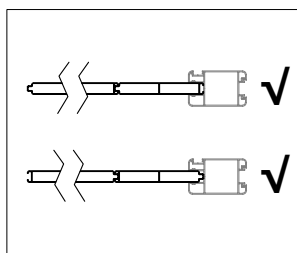
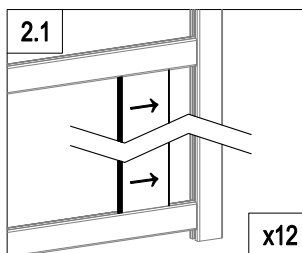
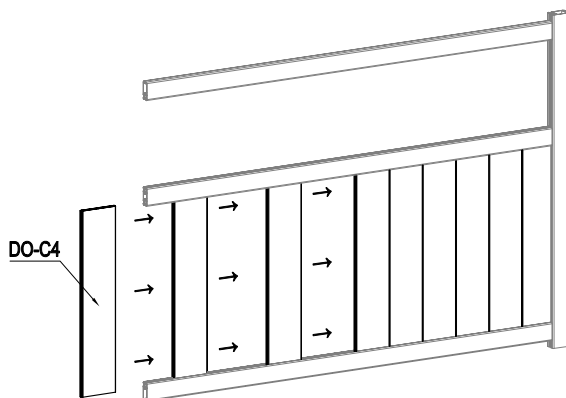

	DO-C4	12
---	-------	----

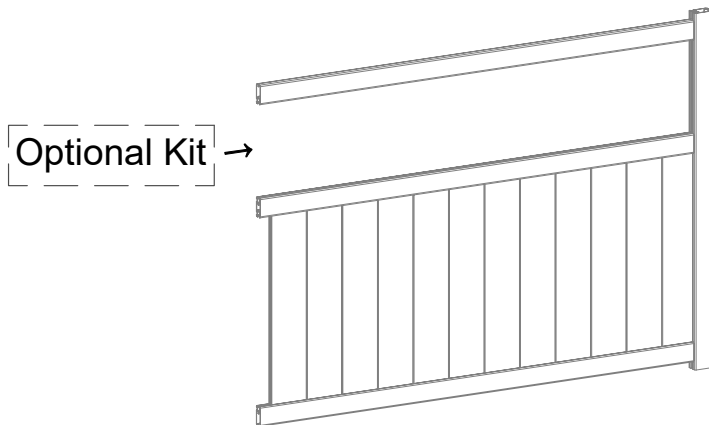

P 11~14



P 15~18



P 19~21

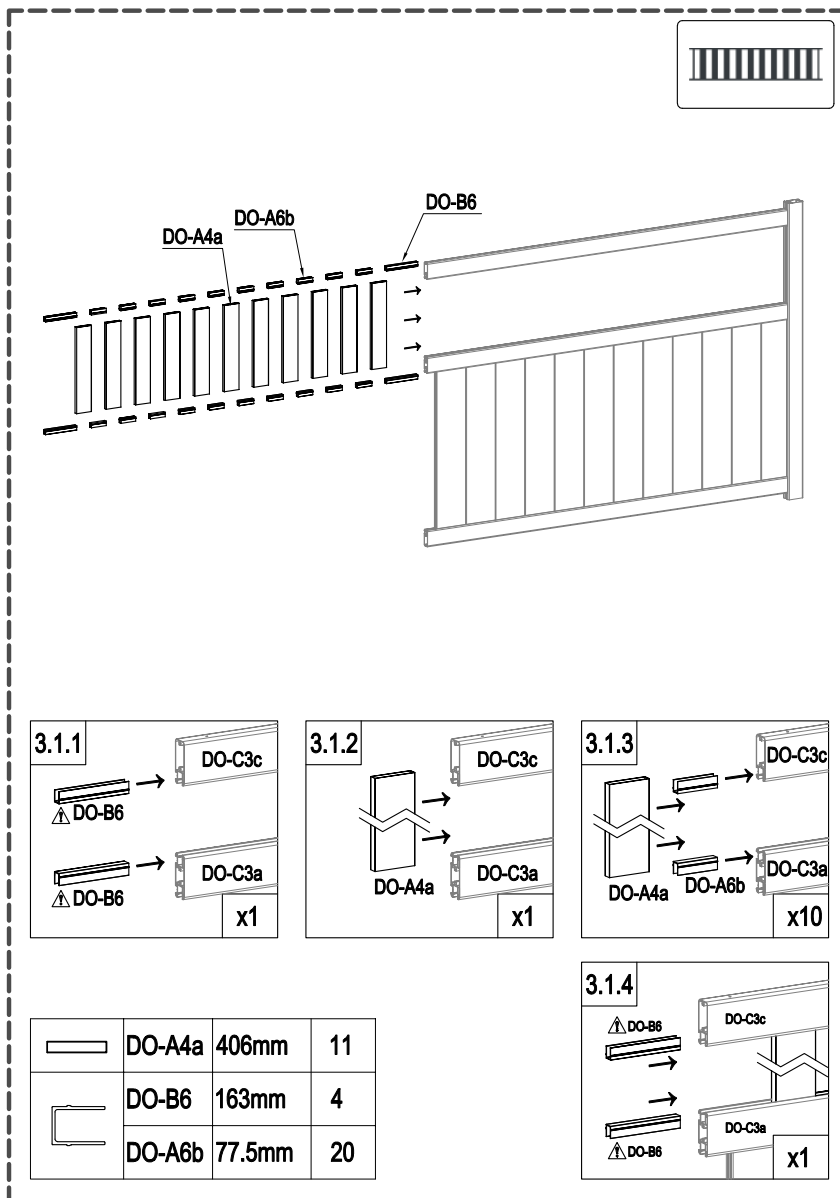

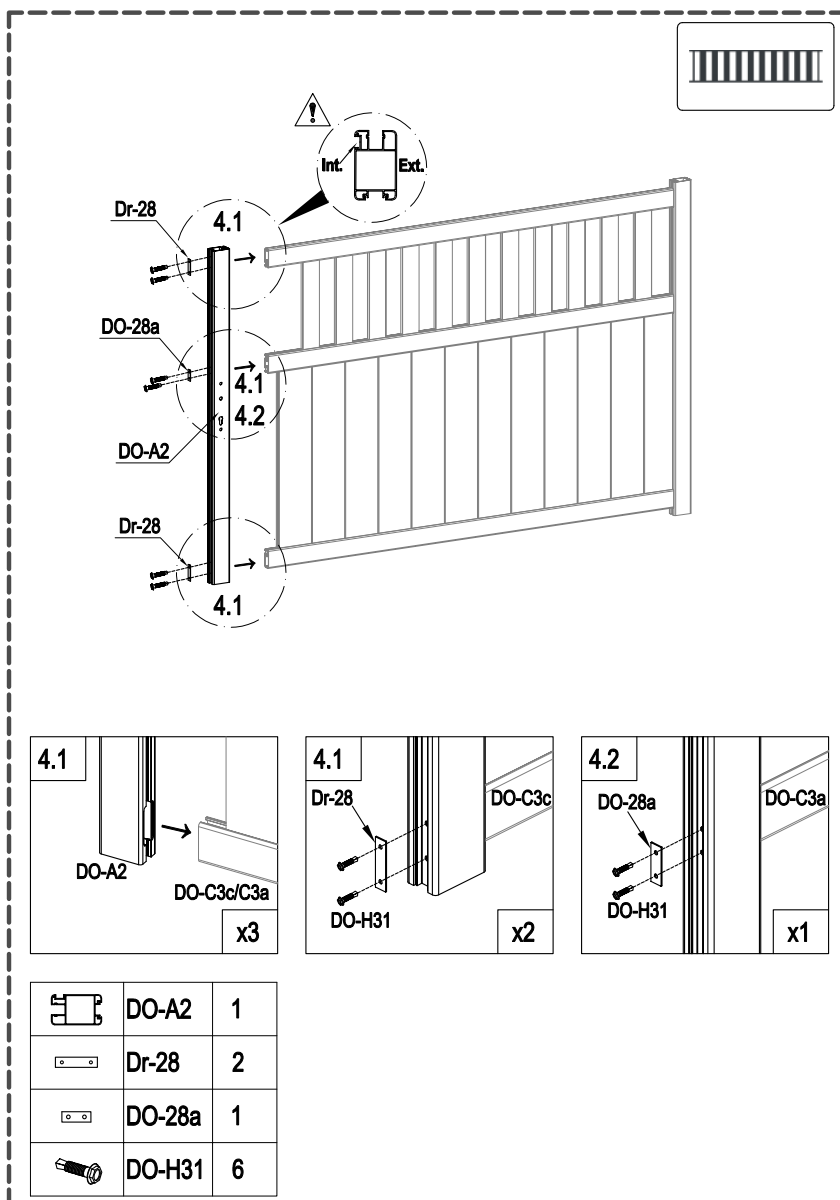

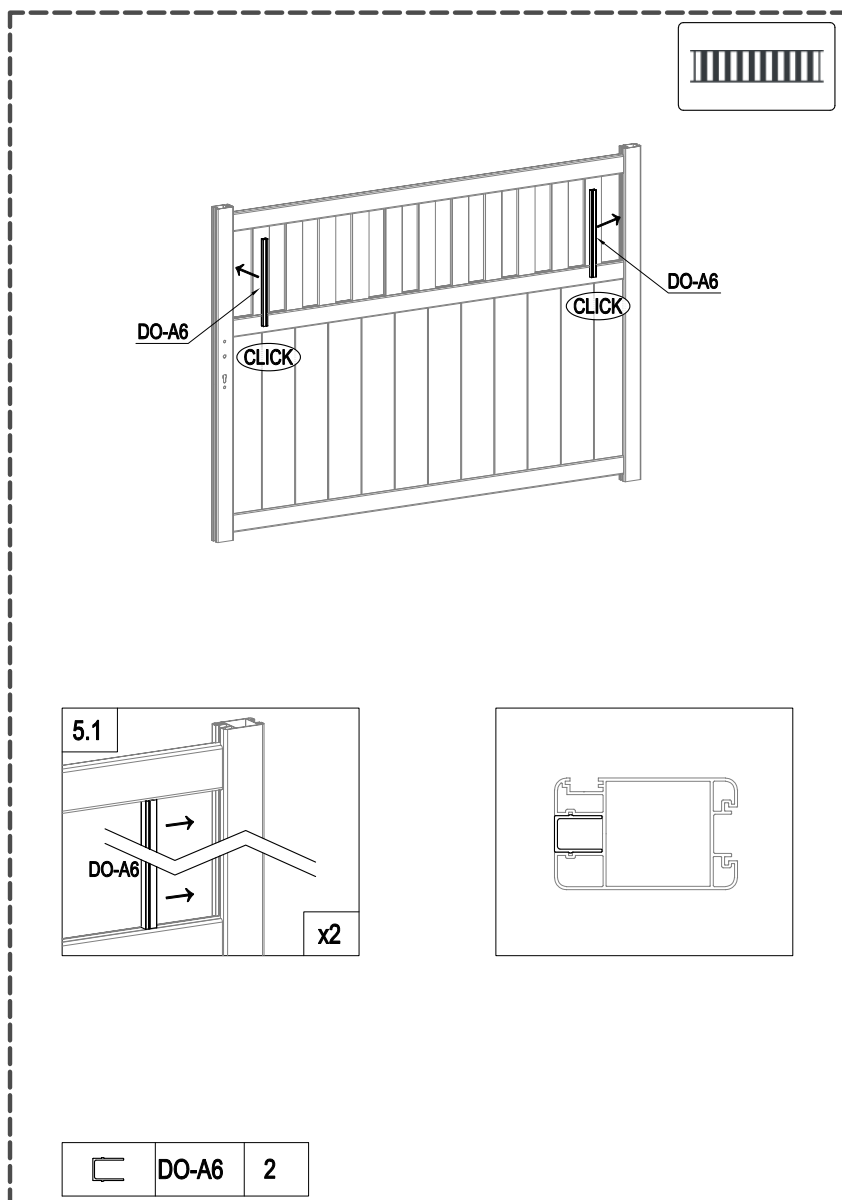

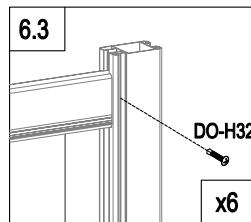
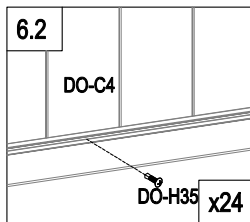
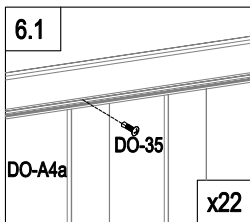
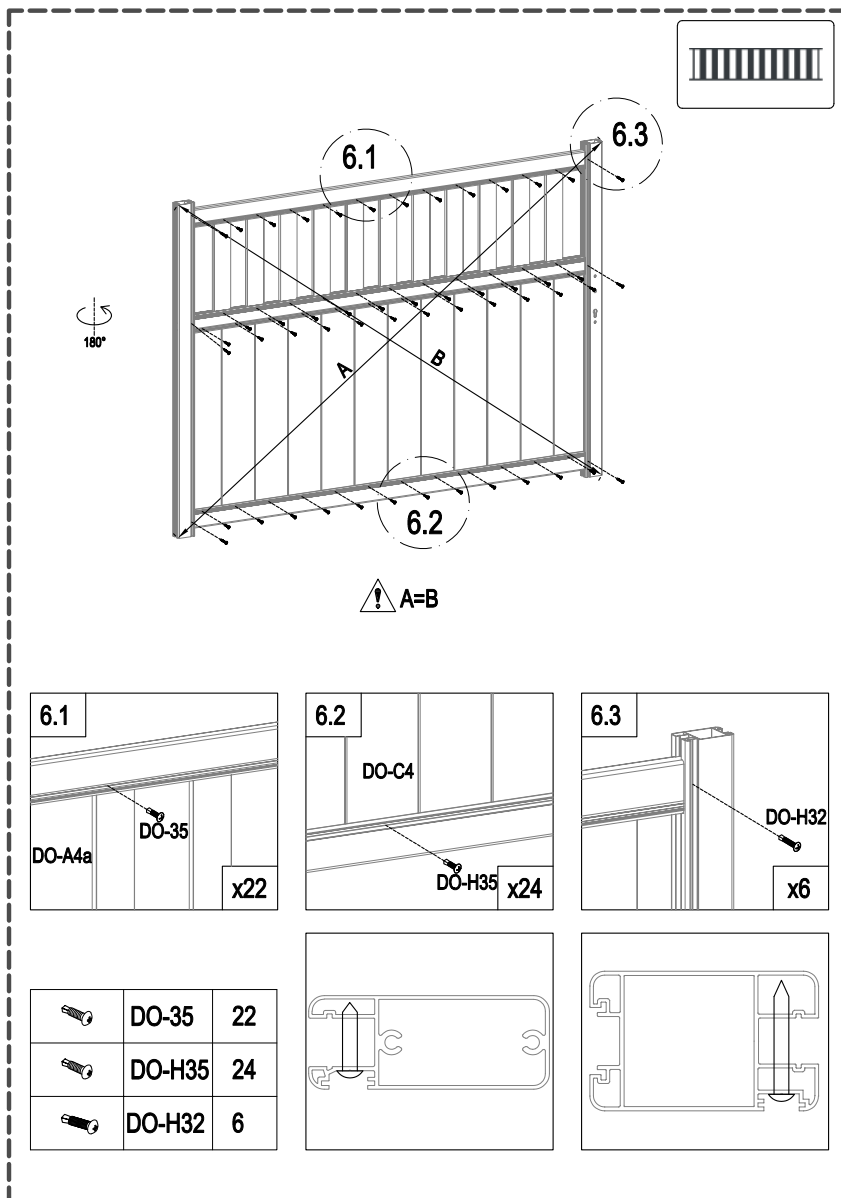

	DO-35	22
	DO-H35	24
	DO-H32	6

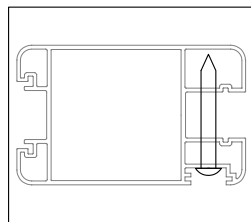
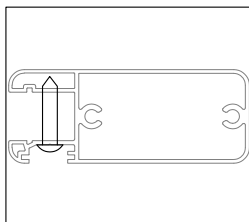

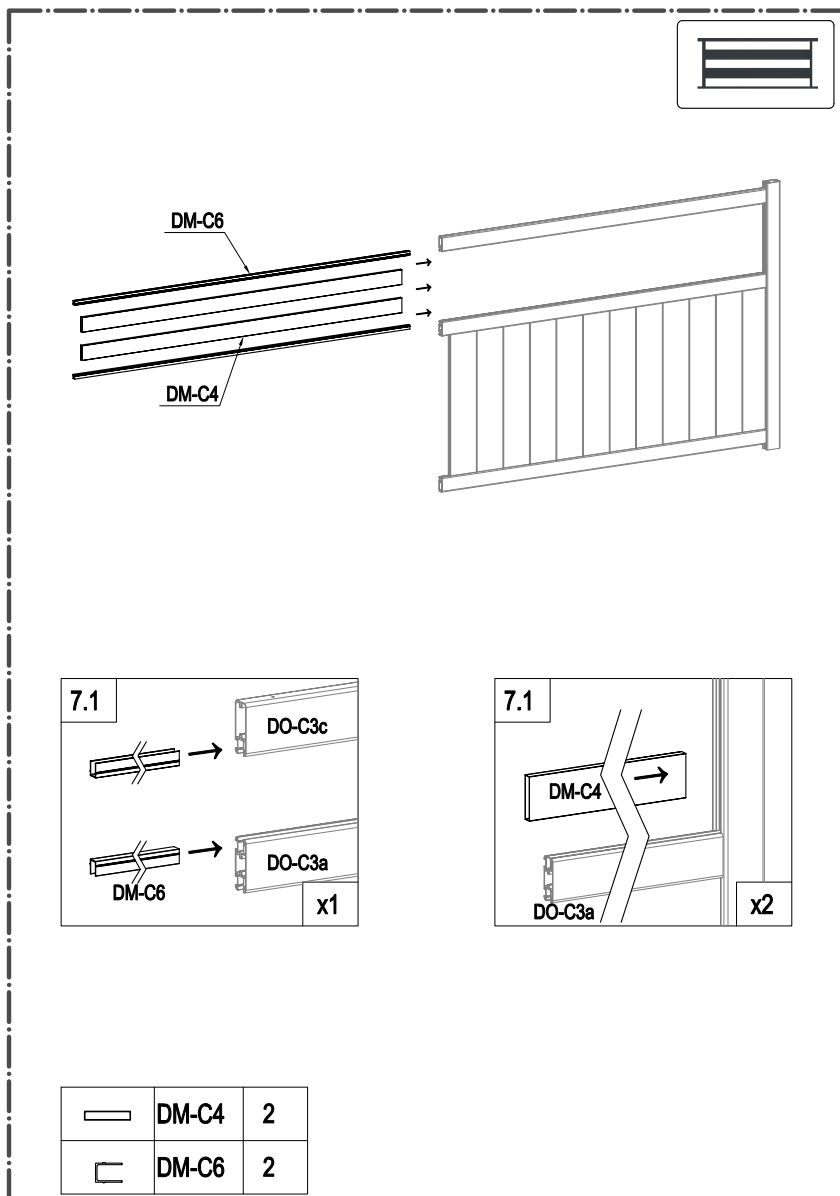

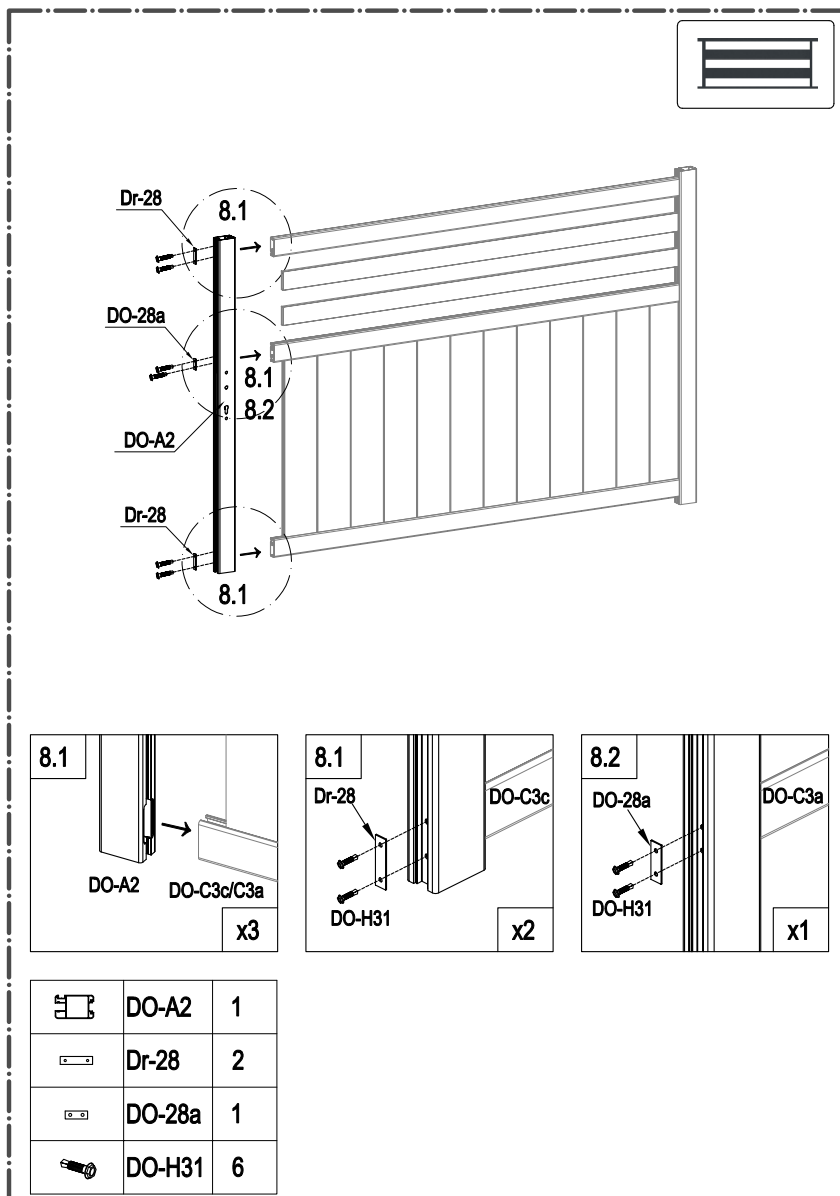

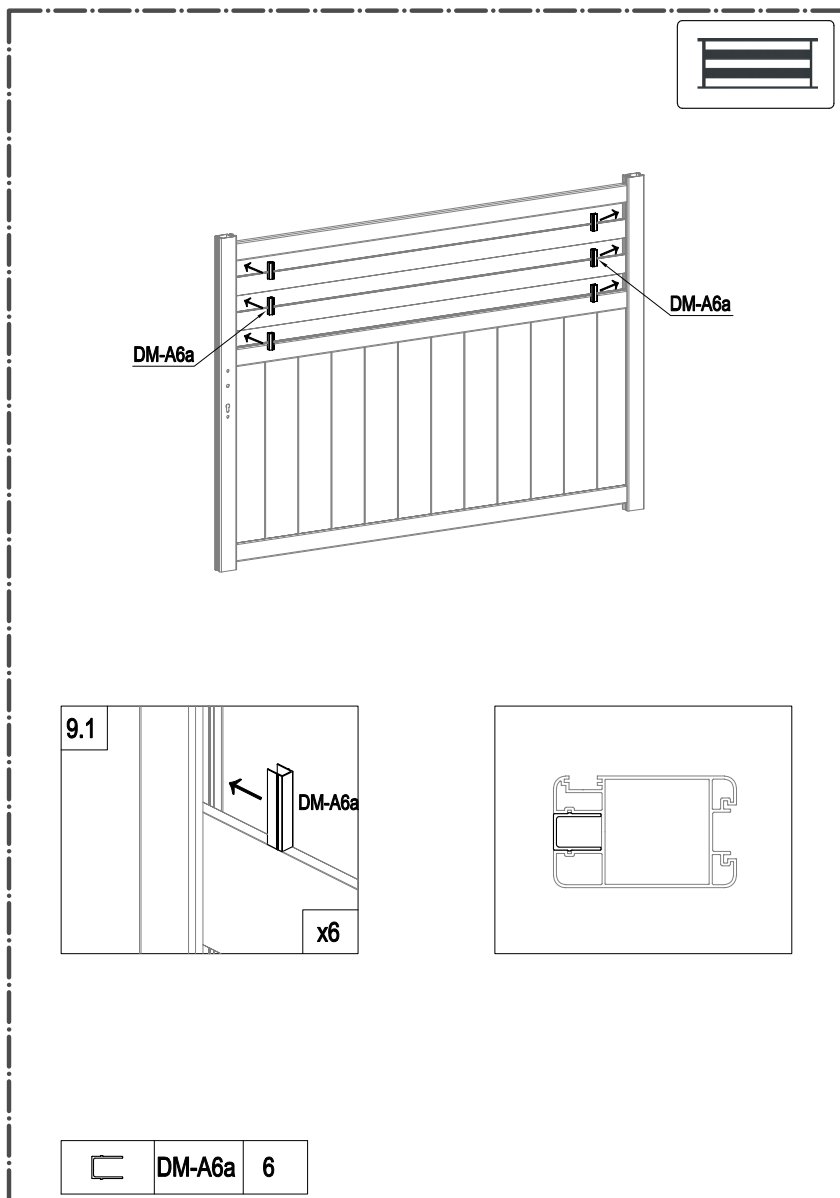

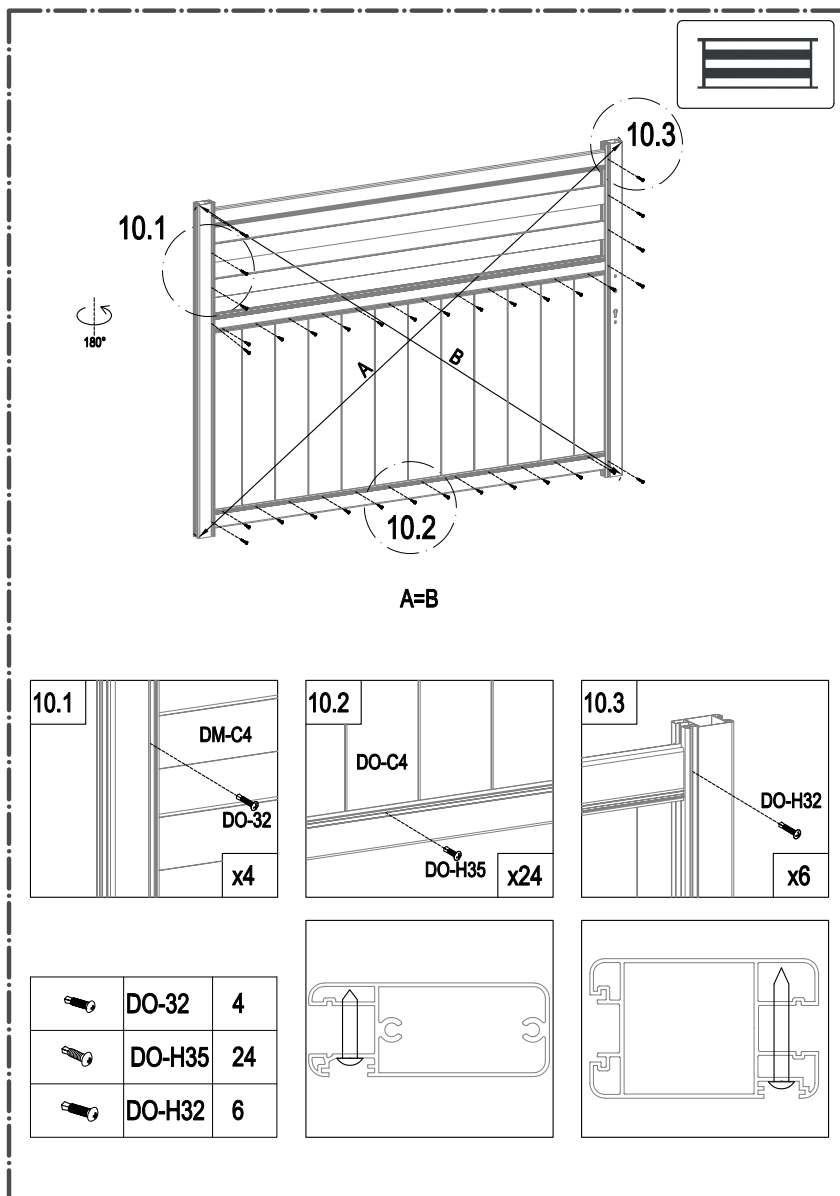

DESIGN

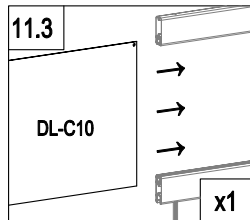
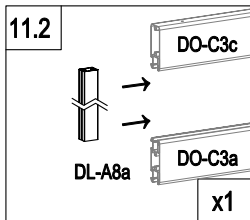
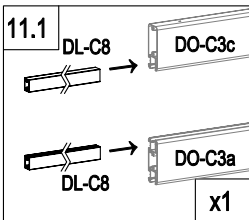
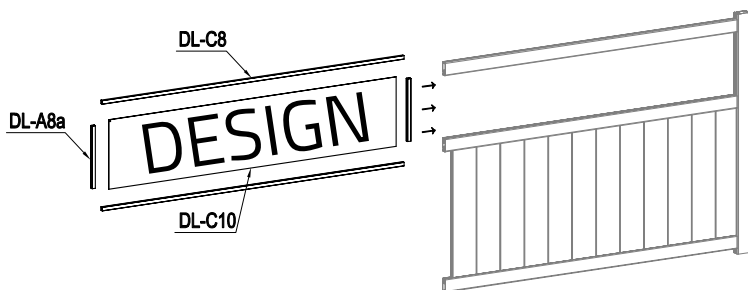

	DL-C10	1
	DL-C8	2
	DL-A8a	2

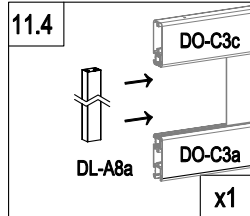

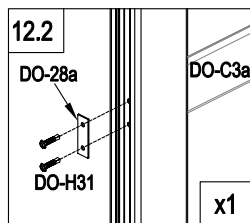
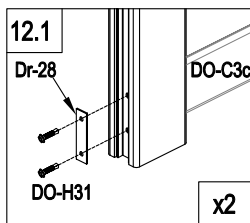
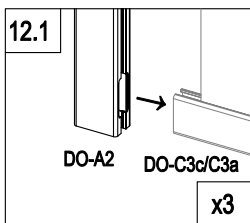
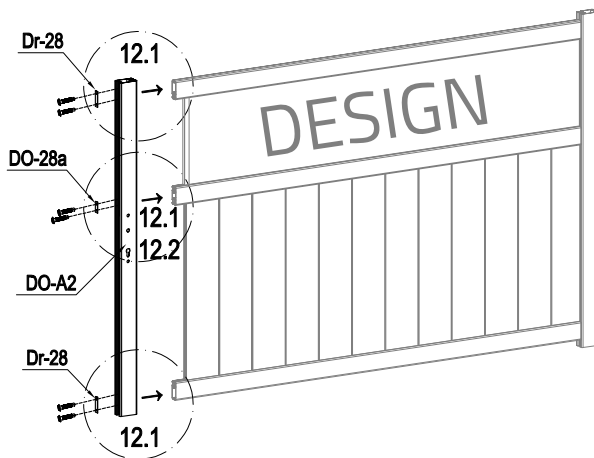

DESIGN

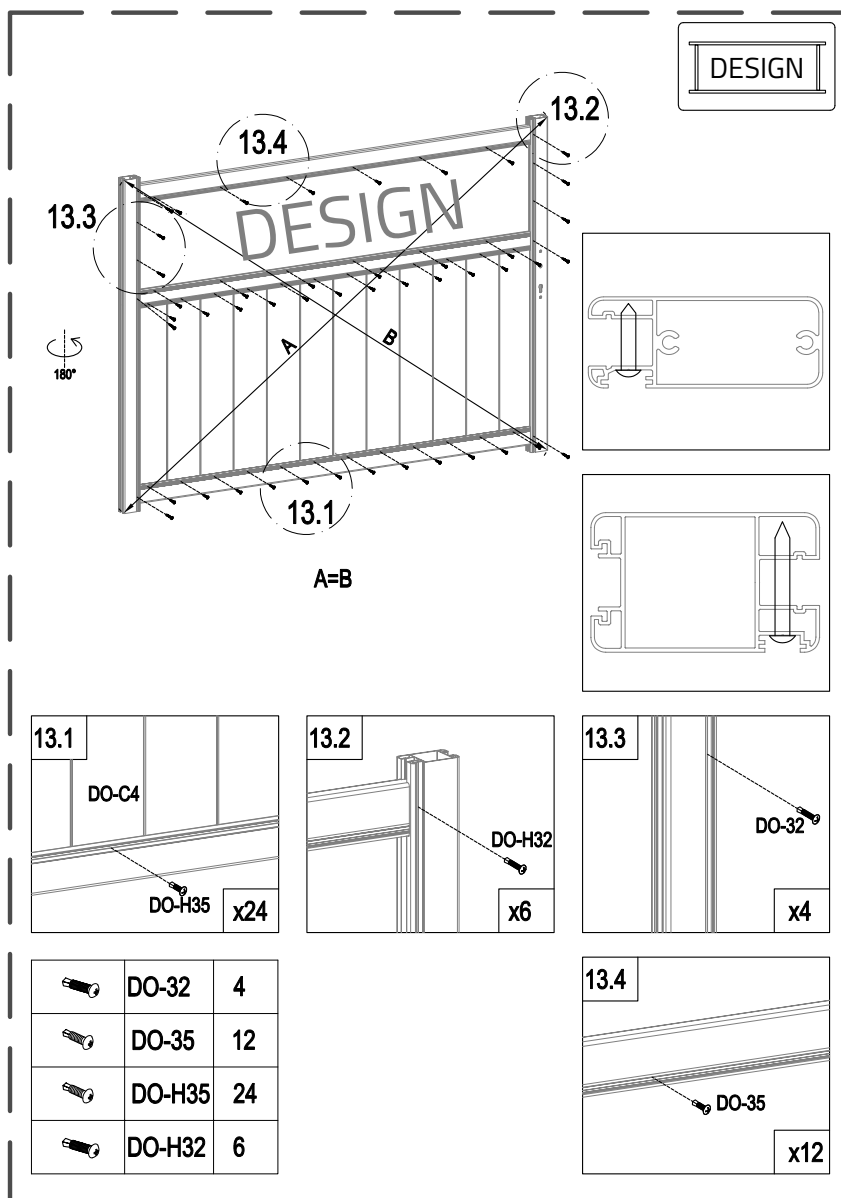

	DO-A2	1
	Dr-28	2
	DO-28a	1
	DO-H31	6

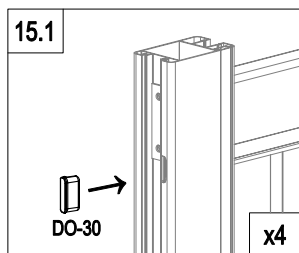
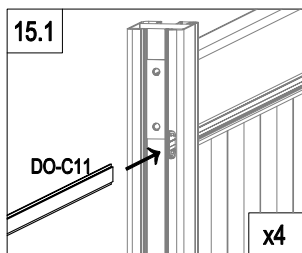
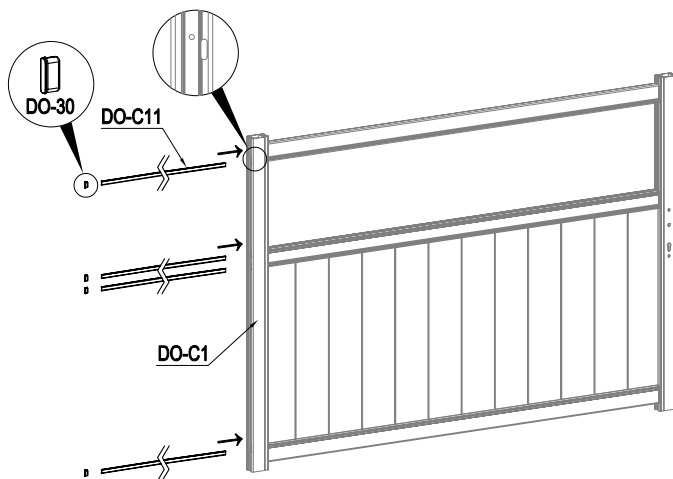



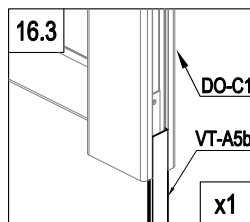
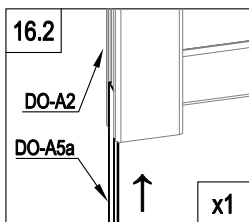
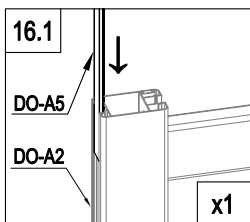
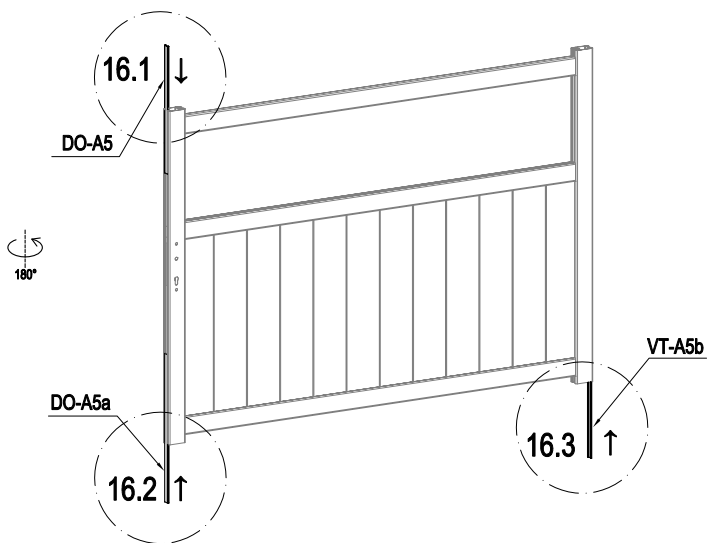

	DO-C11	4
	DO-30	4

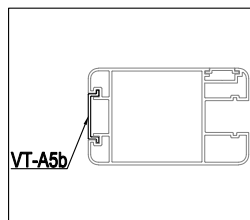

	VT-A5b	1
	DO-A5	1
	DO-A5a	1

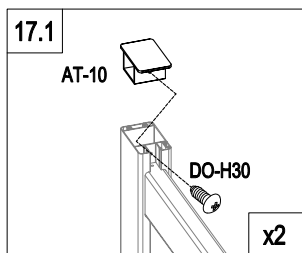
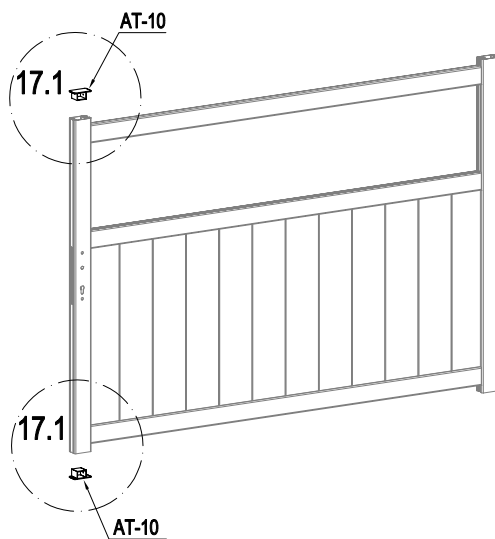



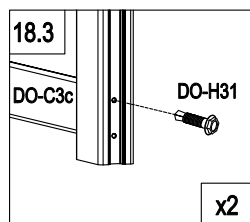
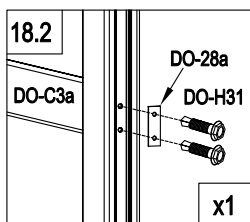
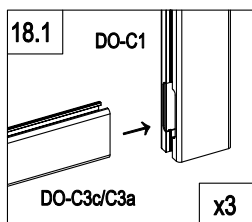
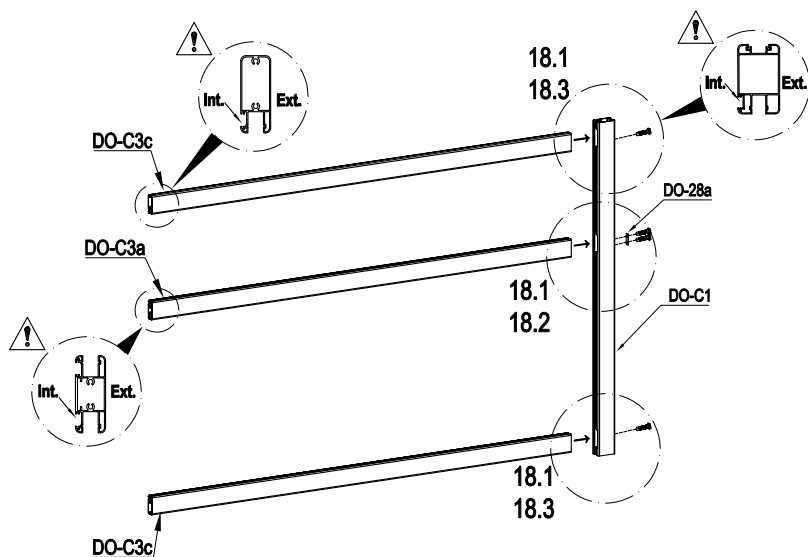

	AT-10	2
	DO-H30	2

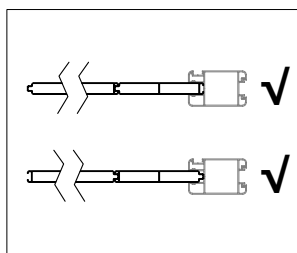
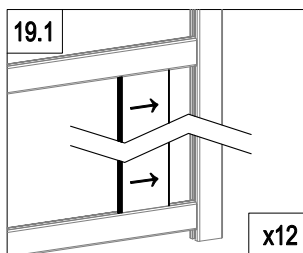
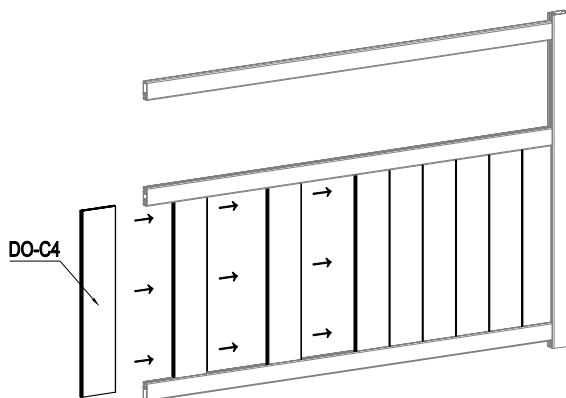

	DO-C1	1
	DO-C3c	2
	DO-C3a	1

	DO-28a	1
	DO-H31	4



	DO-C4	12
---	-------	----

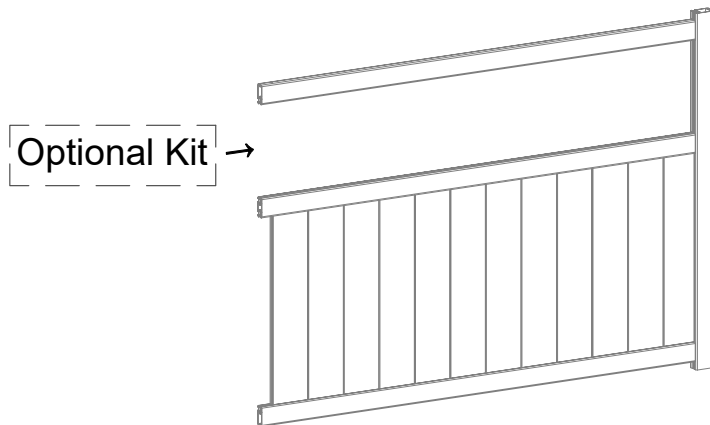

P 29~32



P 33~36



P 37~39

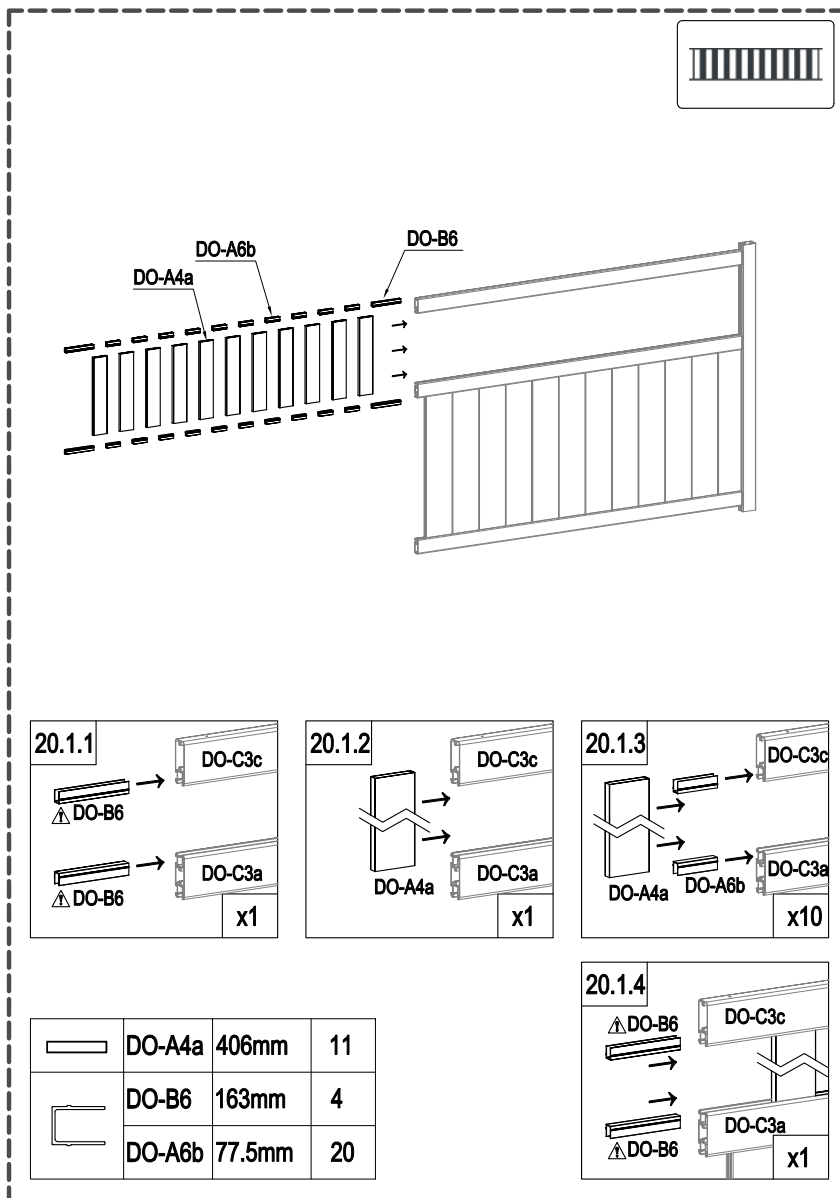

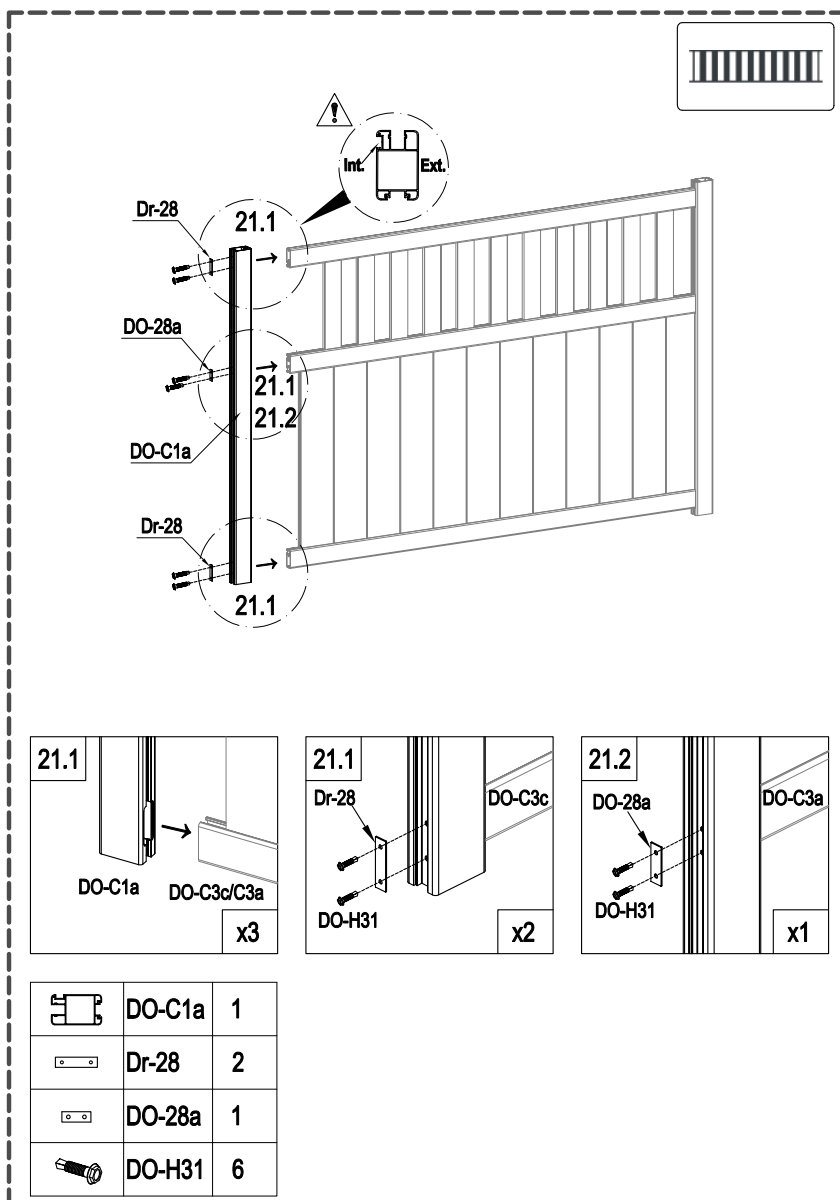

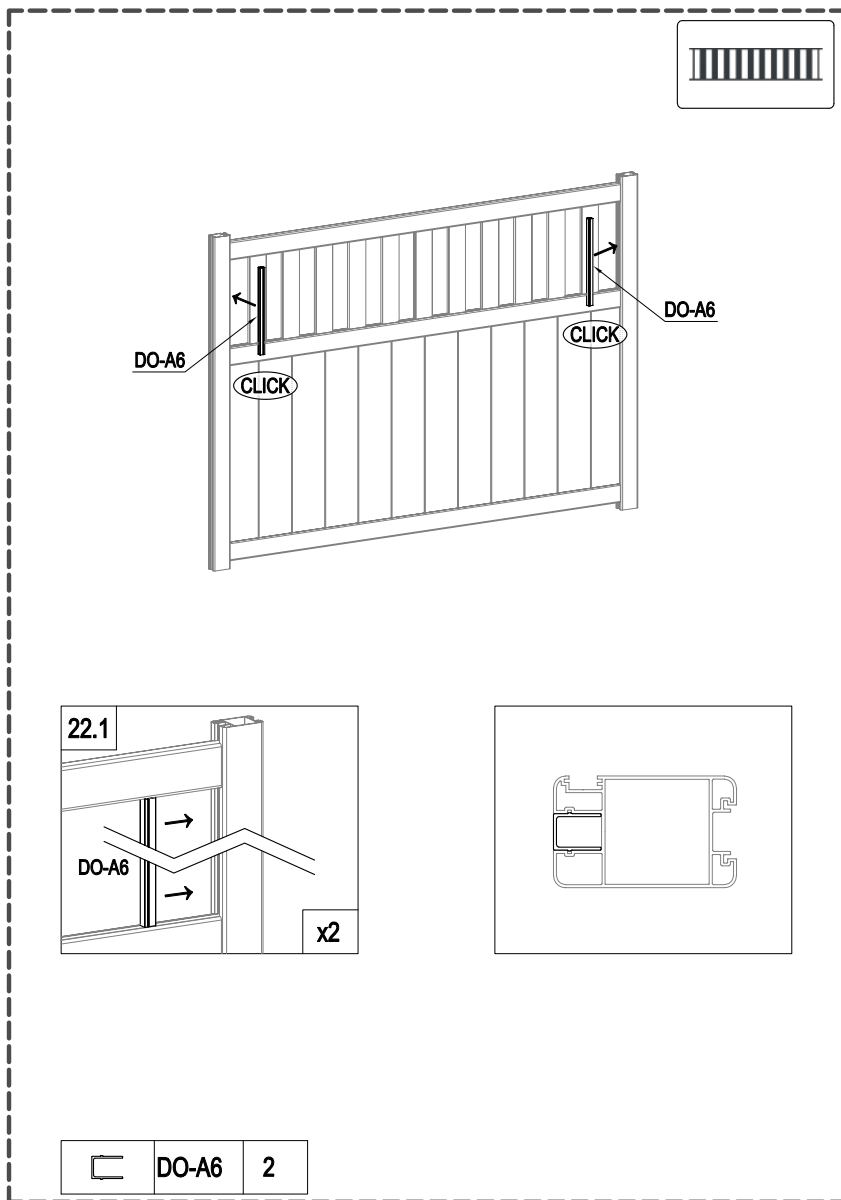

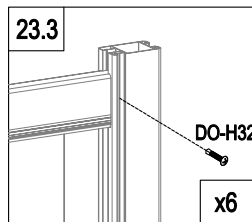
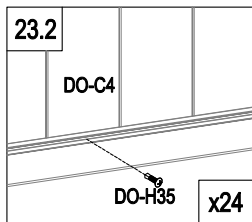
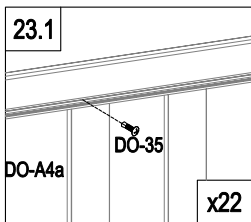
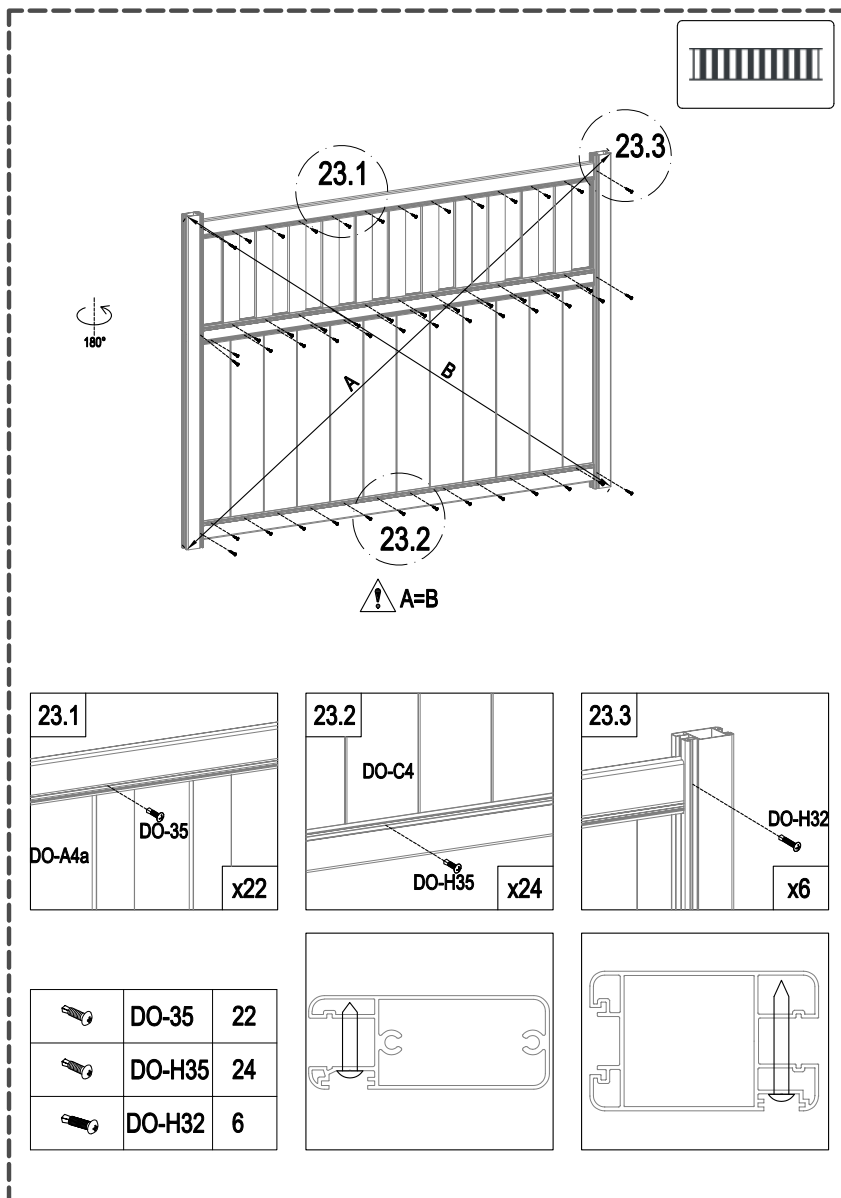

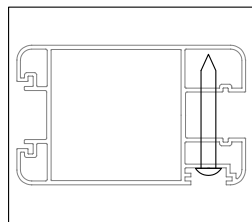
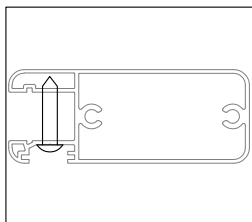

	DO-35	22
	DO-H35	24
	DO-H32	6

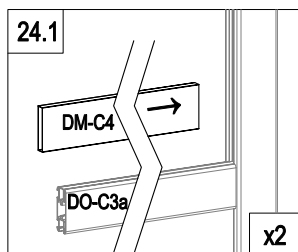
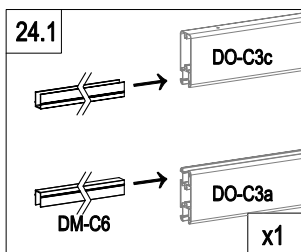
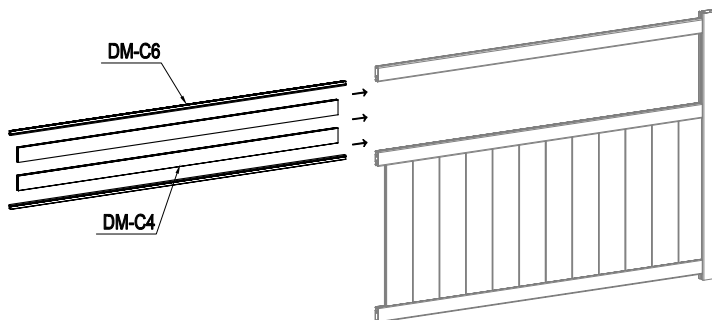



	DM-C4	2
	DM-C6	2

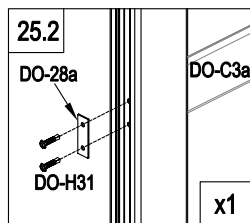
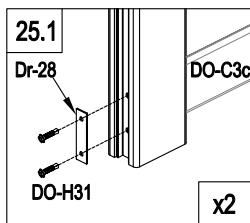
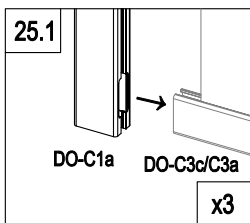
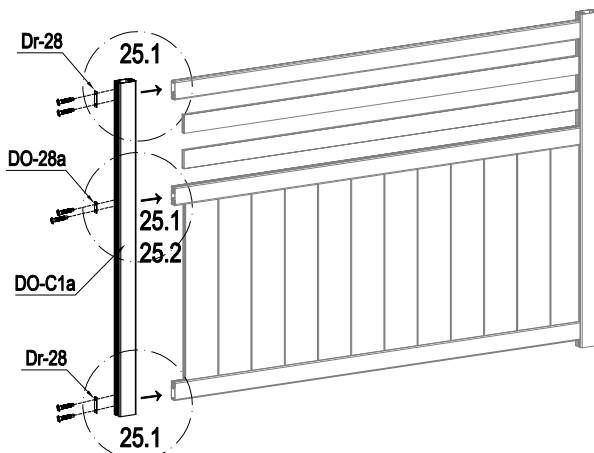

	DO-C1a	1
	Dr-28	2
	DO-28a	1
	DO-H31	6

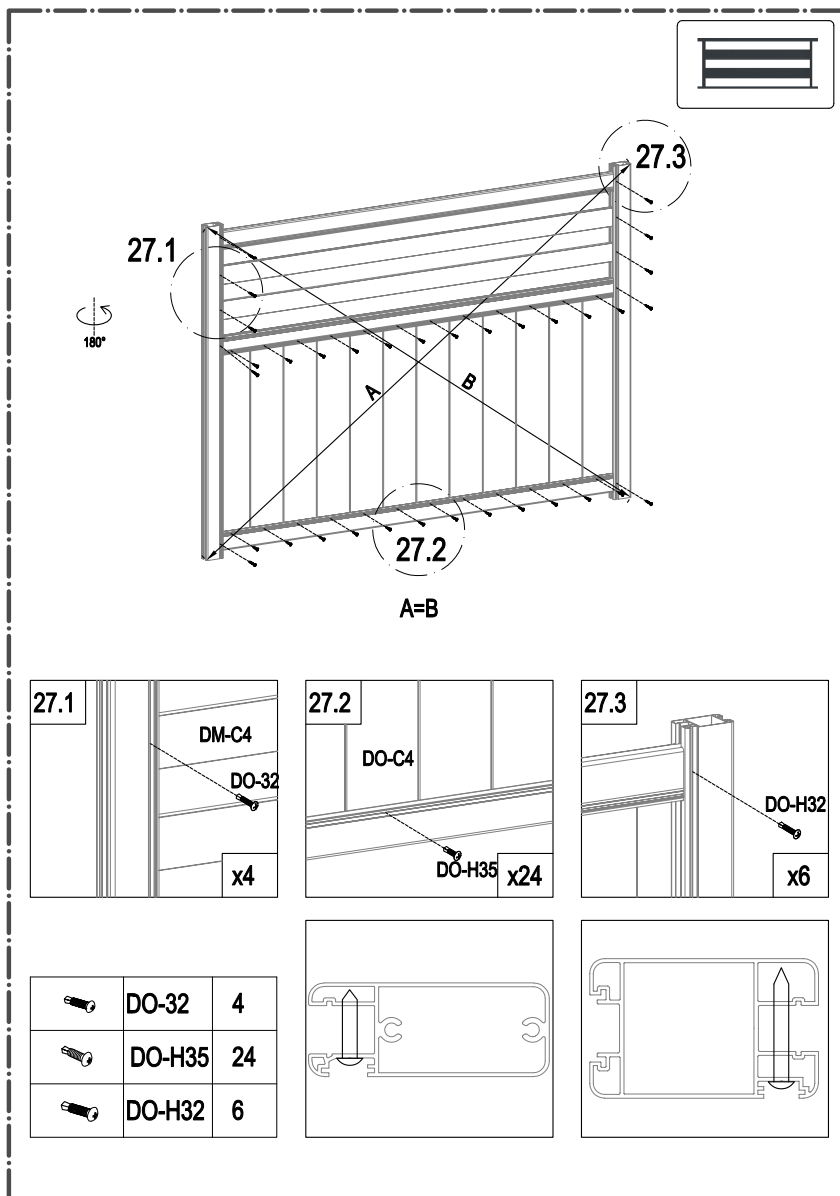

DESIGN

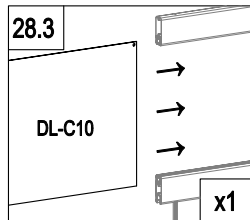
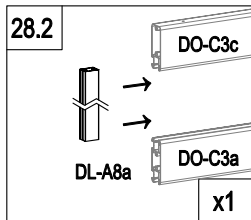
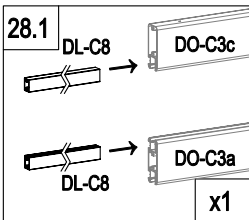
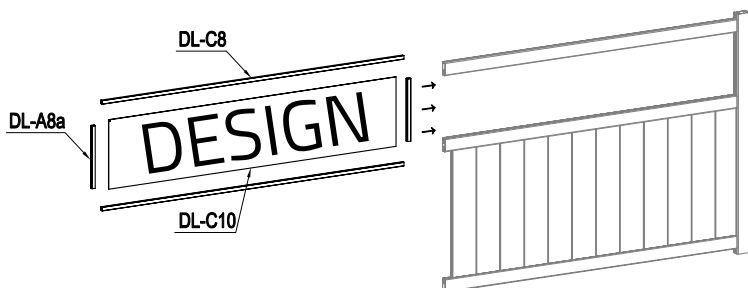

	DL-C10	1
	DL-C8	2
	DL-A8a	2

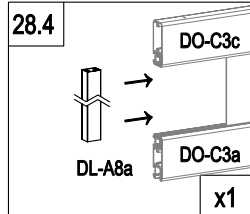

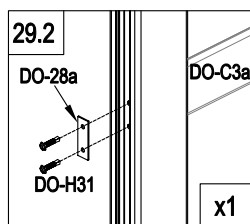
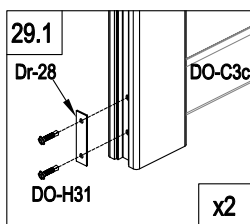
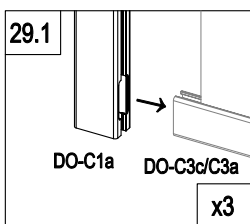
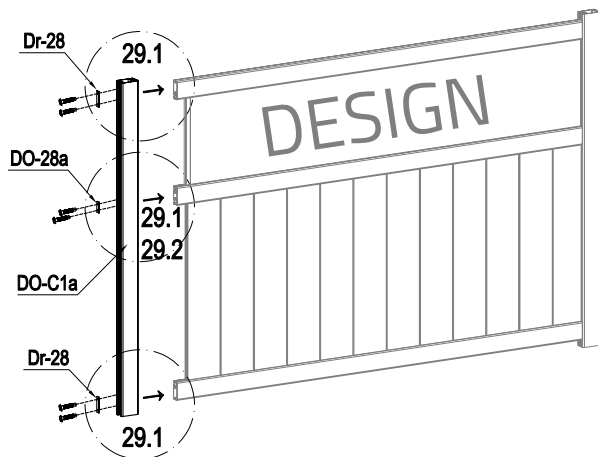

DESIGN



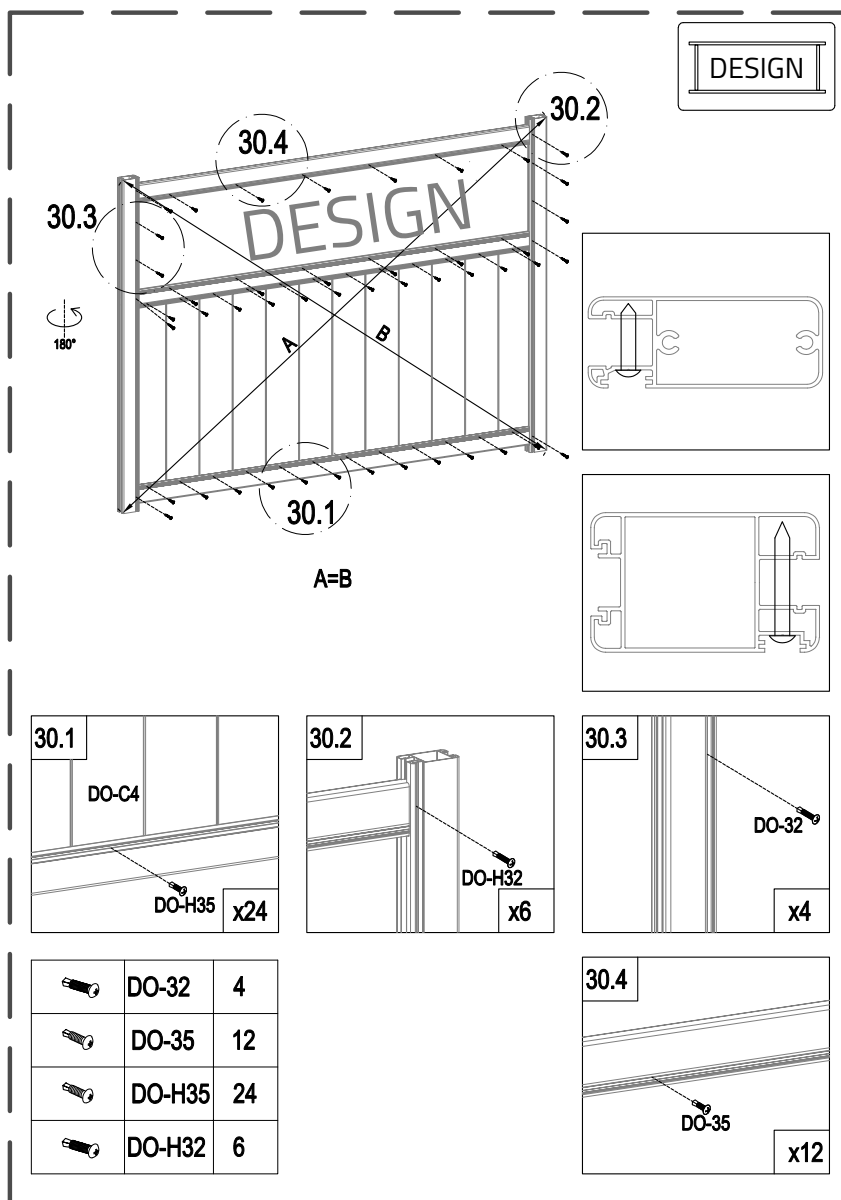

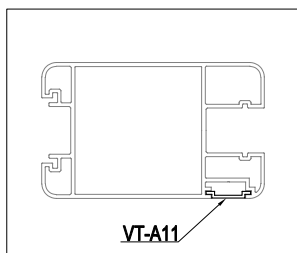
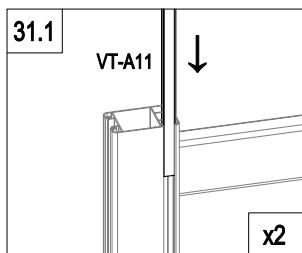
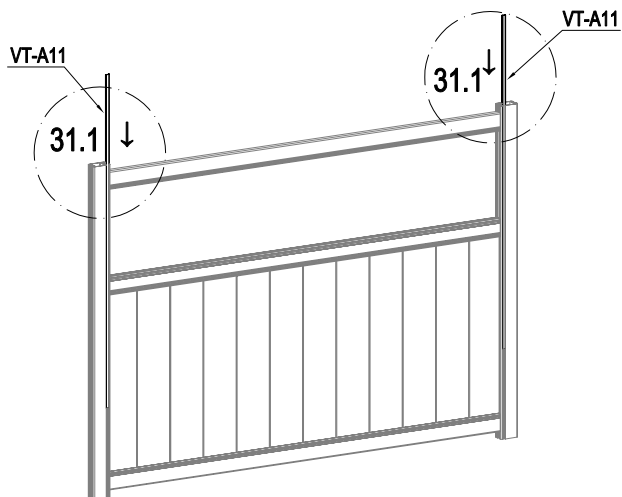
	DO-C1a	1
	Dr-28	2
	DO-28a	1
	DO-H31	6





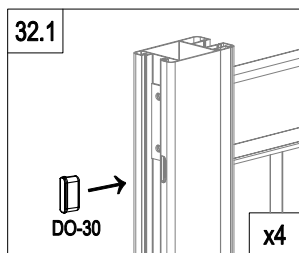
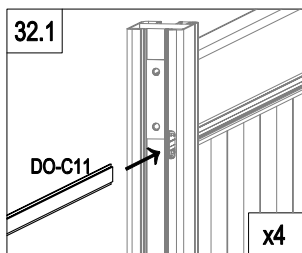
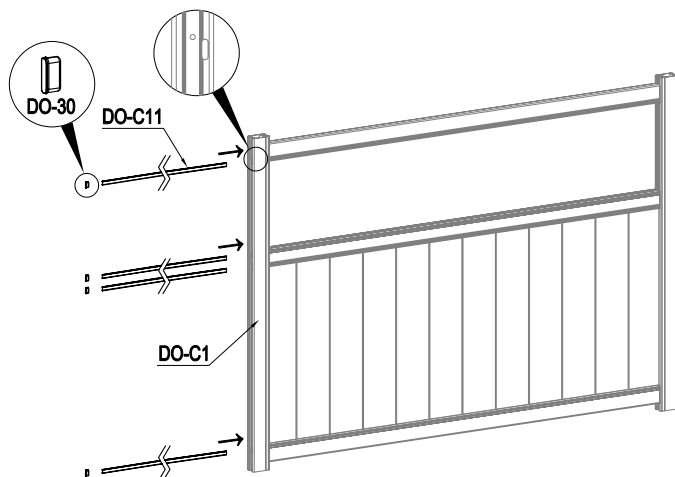



	VT-A11	2
---	---------------	----------

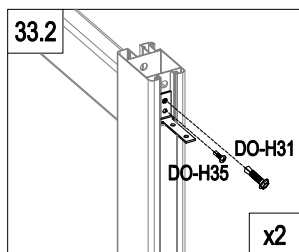
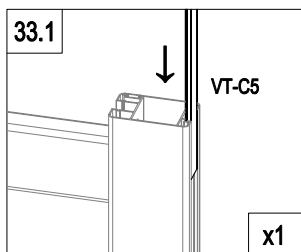
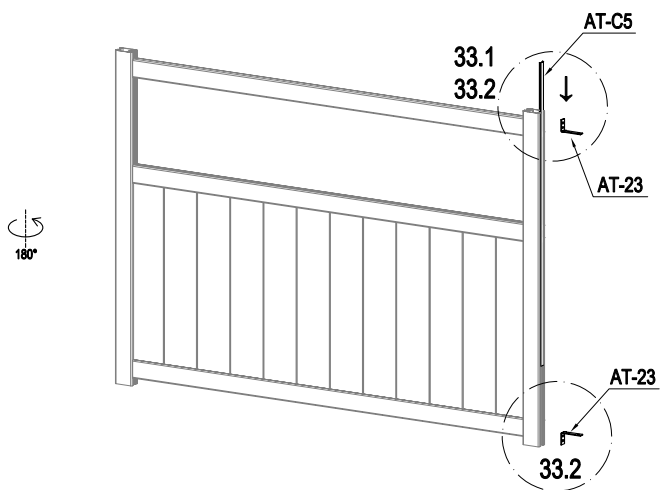





	DO-C11	4
	DO-30	4

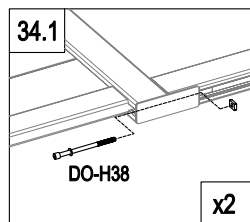
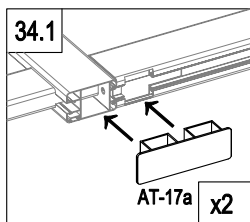
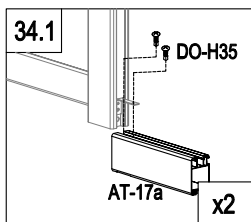
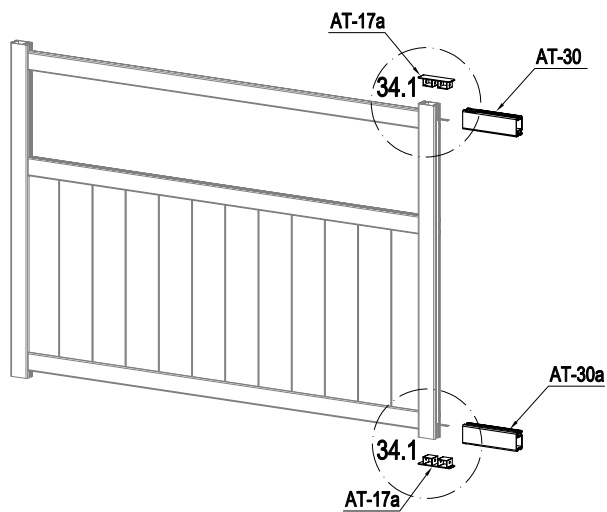





	VT-C5	1
	AT-23	2
	DO-H31	2
	DO-H35	2



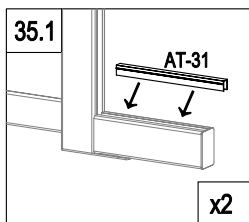
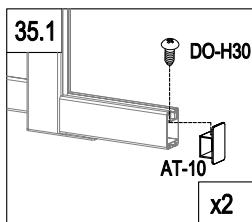
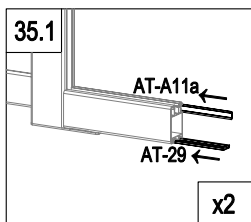
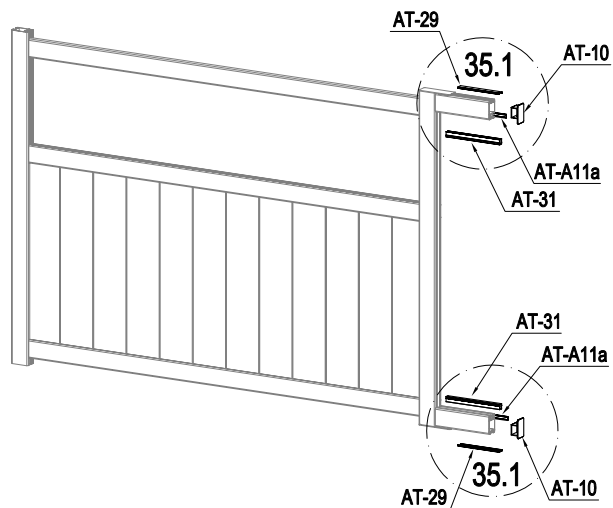

	AT-30	1
	AT-30a	1
	AT-17a	2

	DO-H38	2
	DO-H35	4



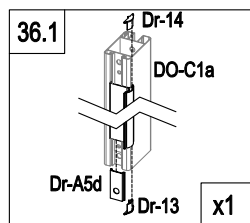
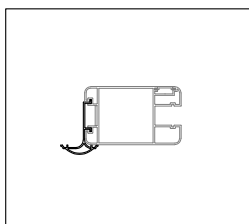
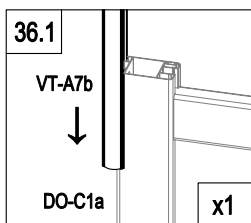
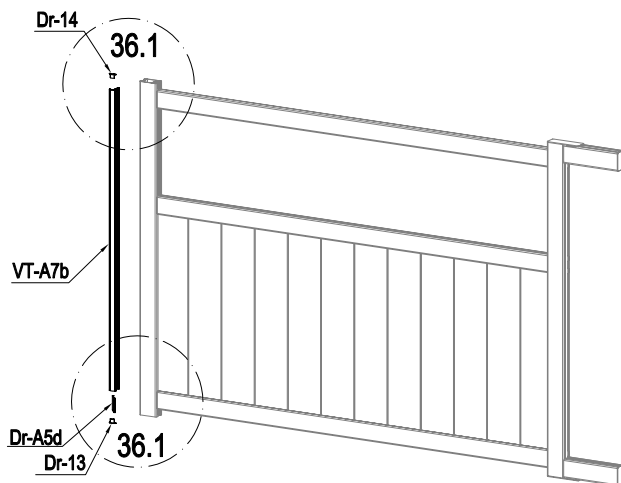

	AT-29	2
	AT-A11a	2
	AT-31	2

	AT-10	2
	DO-H30	2

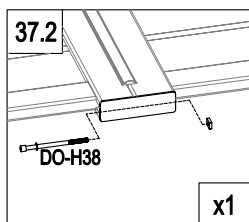
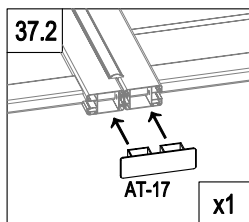
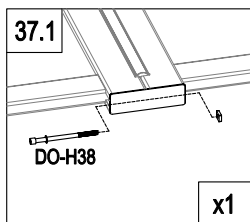
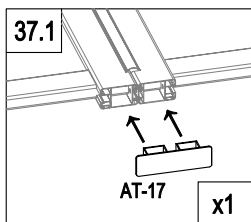
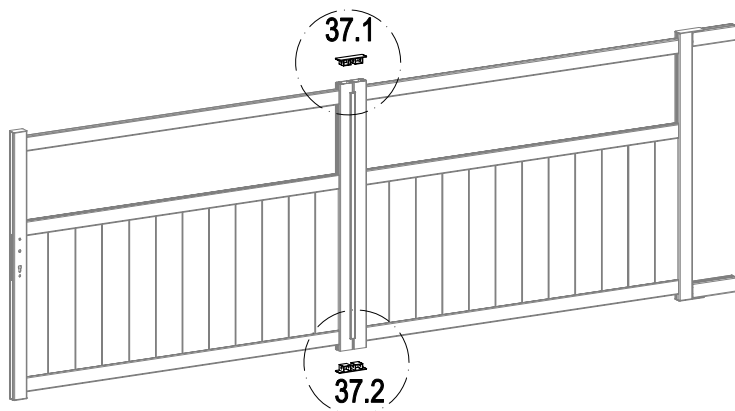

	VT-A7b	1
	Dr-A5d	1
	Dr-13	1
	Dr-14	1



	AT-17	2
	DO-H38	2

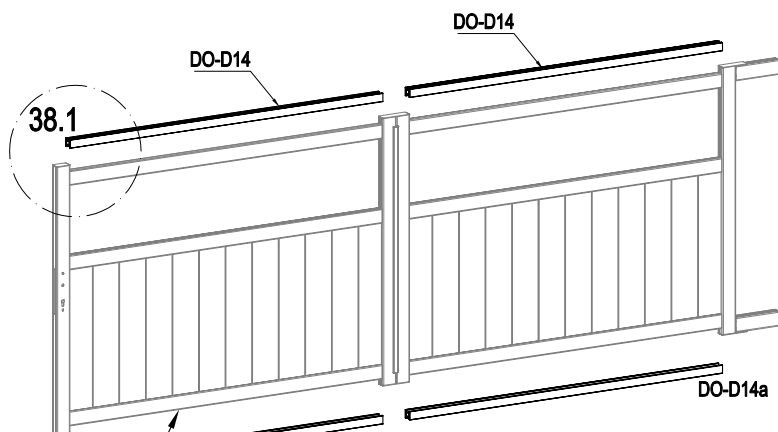



DO-D14a



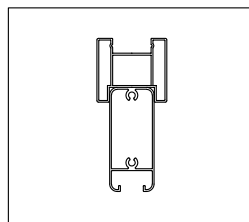
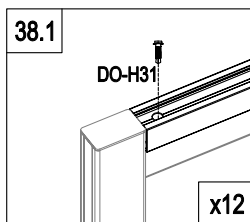
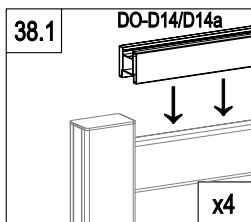

EN: These parts are made for connecting your gate's automation
 FR: Ces pièces sont faites pour relier l'automatisation de votre portail
 DE: Diese Teile sind für den Anschluss der Automatisierung Ihres Tores vorgesehen
 ES: Estas piezas están hechas para conectar la automatización de su puerta
 PT: Estas peças são feitas para ligar a automatização do seu portão
 IT: Queste parti sono realizzate per collegare l'automazione del vostro cancello
 NL: Deze onderdelen zijn gemaakt voor het aansluiten van de automatisering van uw poort.
 PL: Te części są wykonane do podłączenia automatyki bramy.



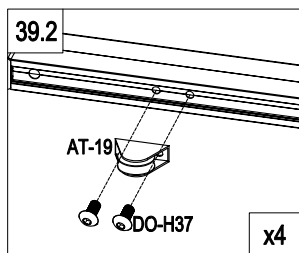
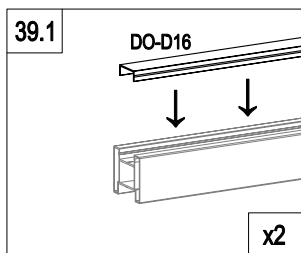
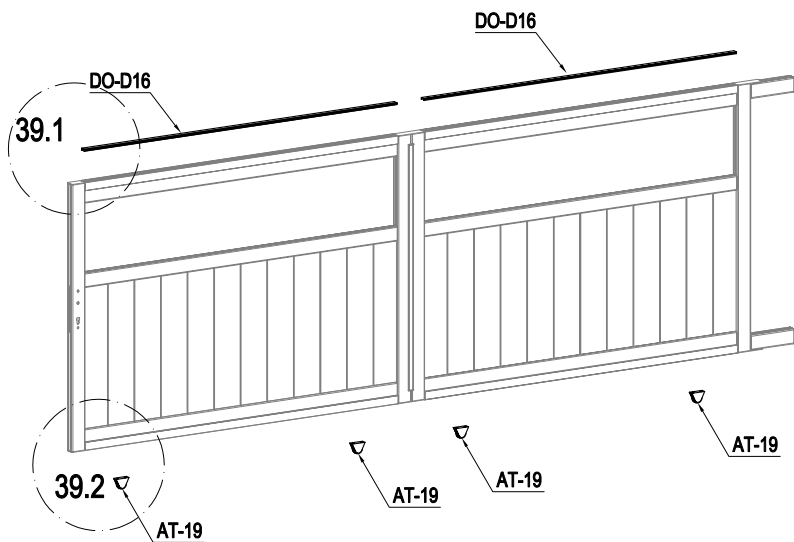

	DO-D14	2
	DO-D14a	2
	DO-H31	12

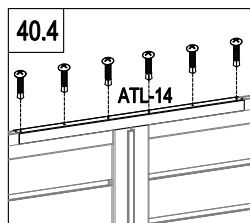
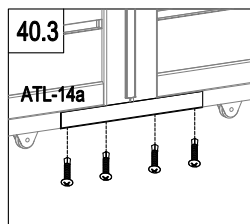
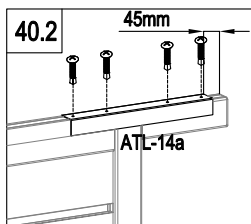
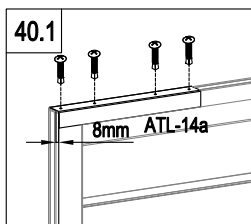
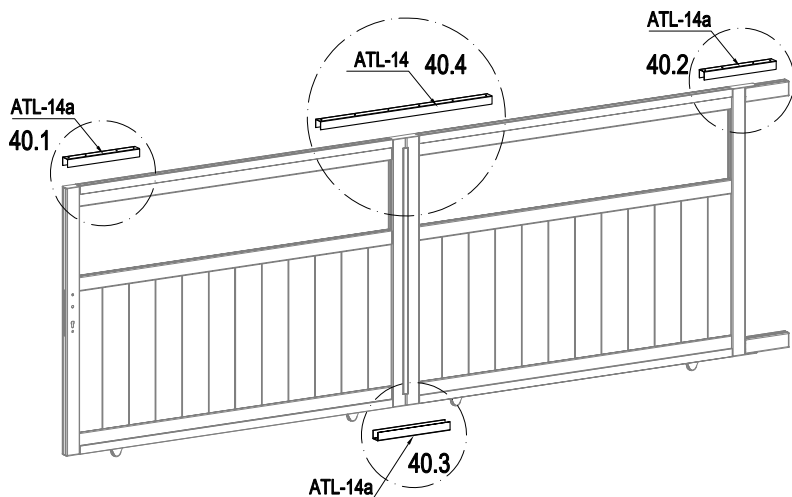

	DO-D16	2
	AT-19	4
	DO-H37	8



	ATL-14	1
	ATL-14a	3
	DO-H34	18

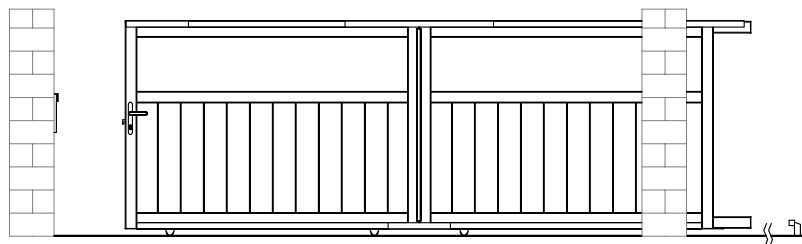

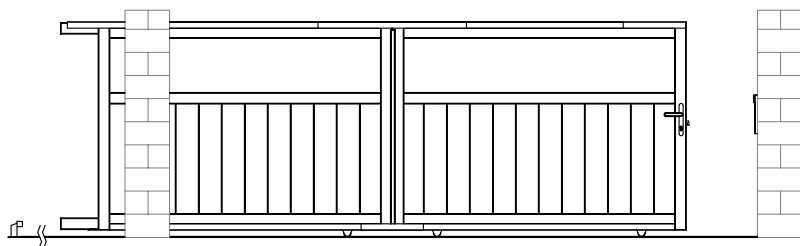

L : P 51~56

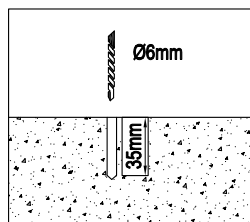
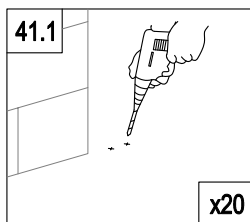
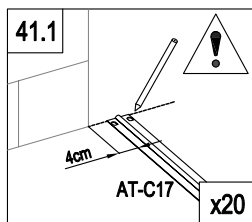
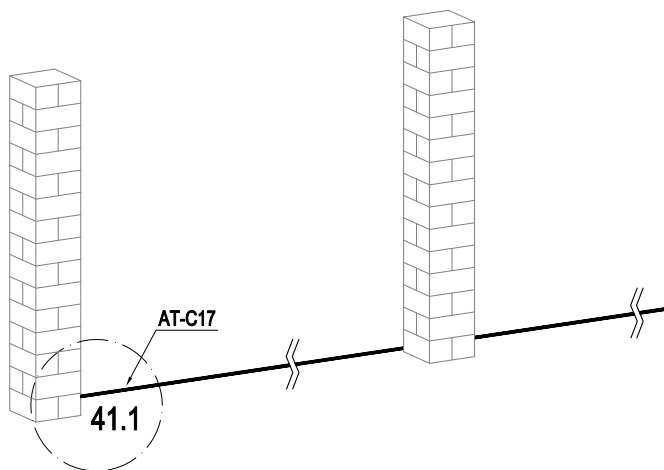

R : P 57~62

L



	AT-C17	5
	DO-H34	40

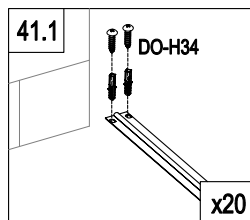

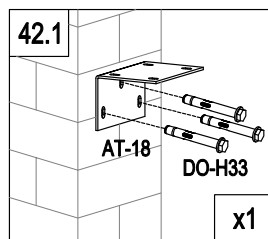
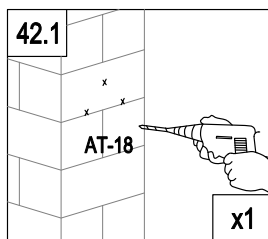
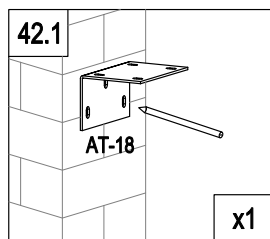
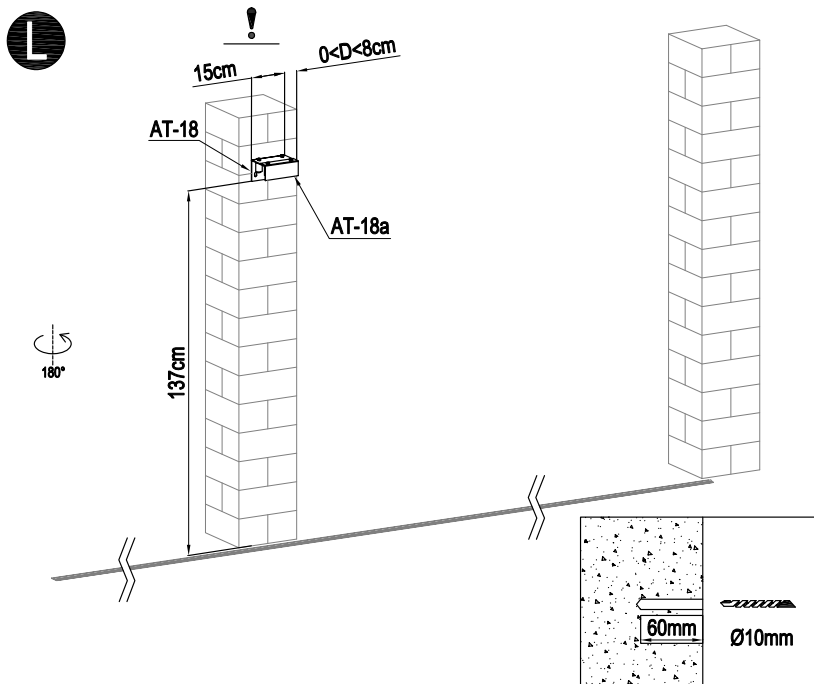

	AT-18	1
	AT-18a	1
	AT-20	4
	DO-H33	3

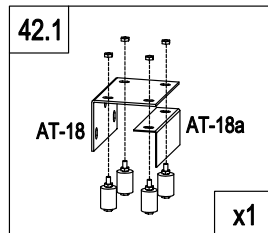
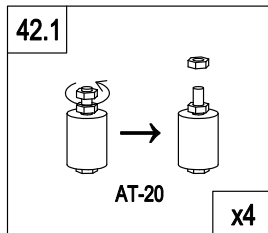

L

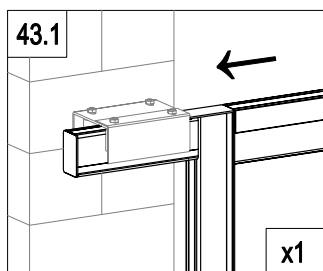
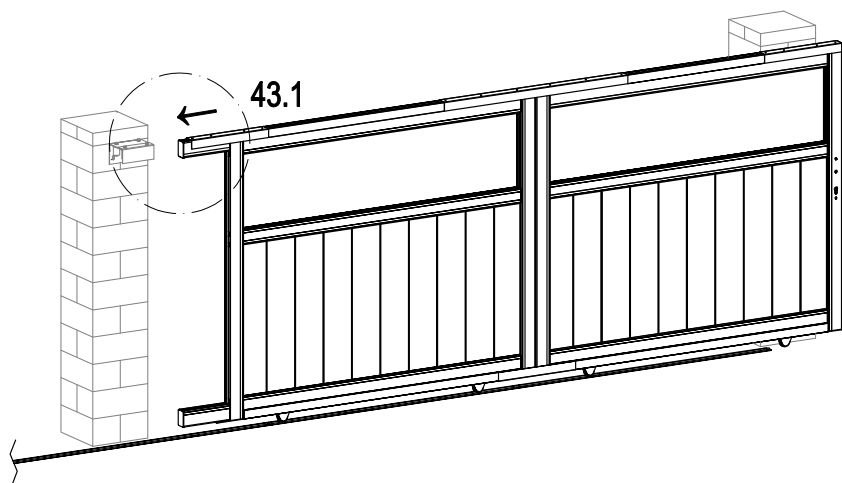

L

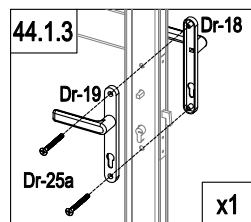
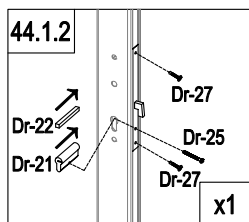
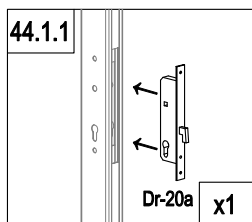
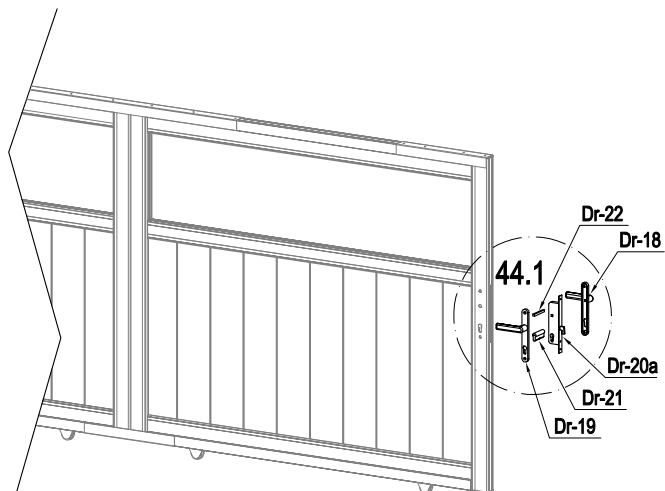

	Dr-20a	1
	Dr-21	1
	Dr-22	1
	Dr-25	1

	Dr-18	1
	Dr-19	1
	Dr-25a	2
	Dr-27	2

L

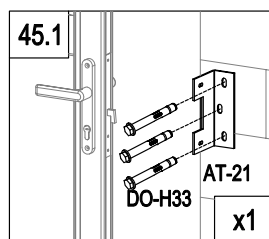
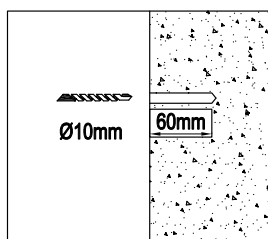
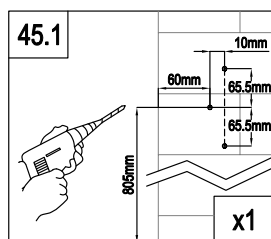
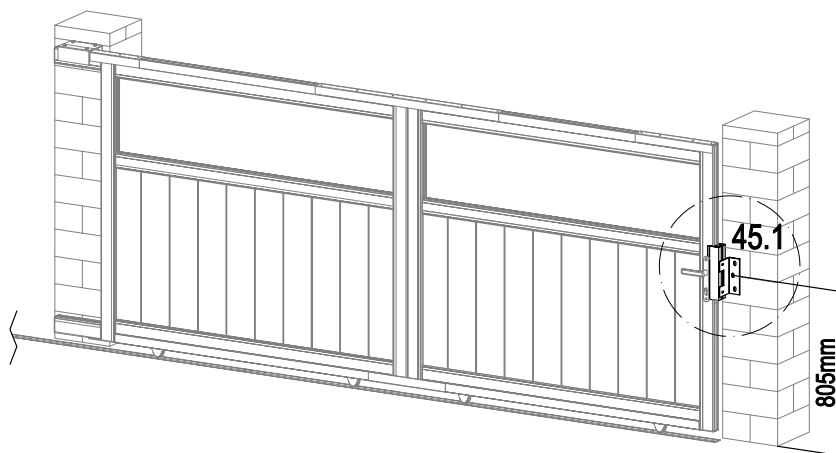

	AT-16	1
	AT-21	1
	DO-H36	2
	DO-H33	3
	AT-22J	3

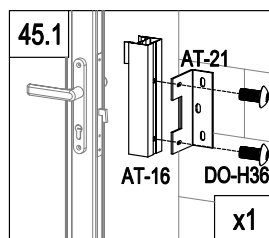
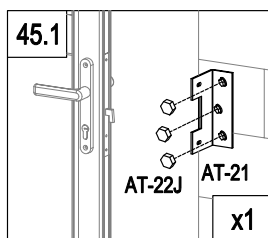

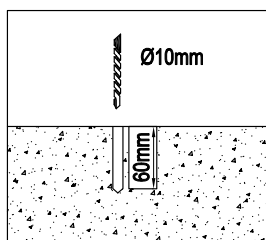
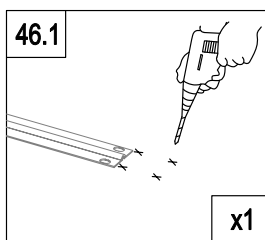
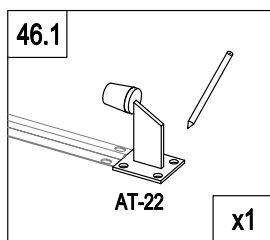
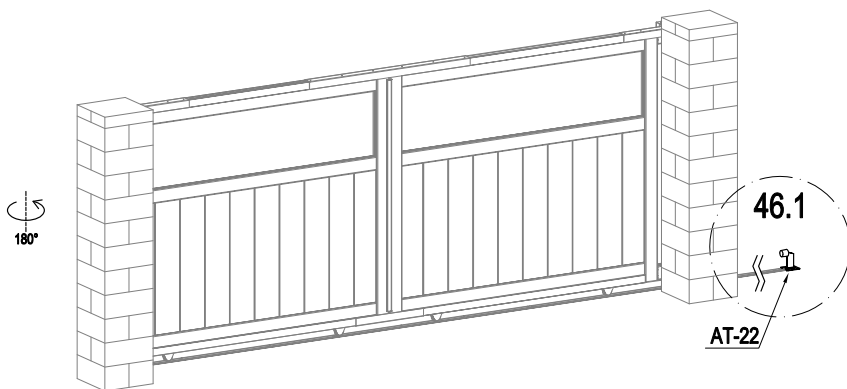

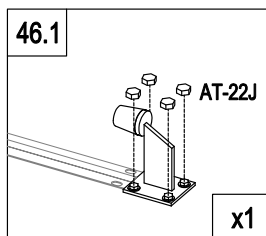
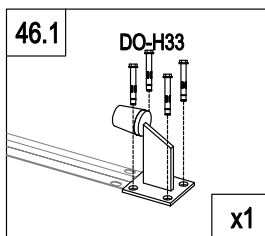

	AT-22	1
	DO-H33	4
	AT-22J	4

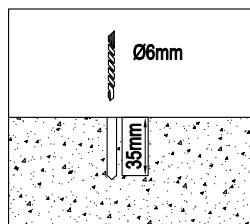
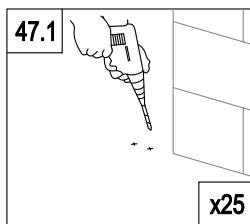
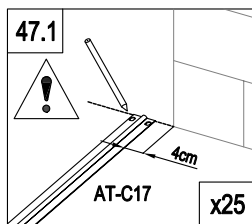
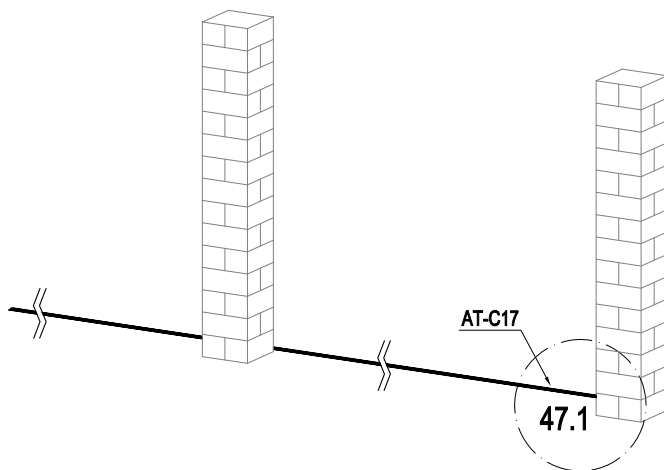

R



	AT-C17	5
	DO-H34	50

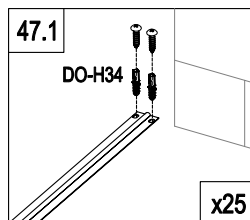

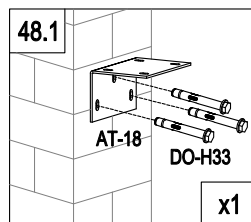
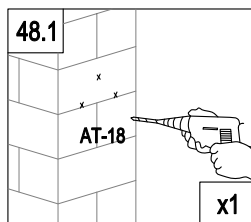
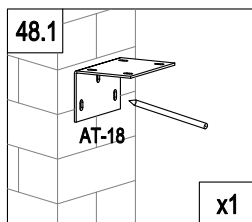
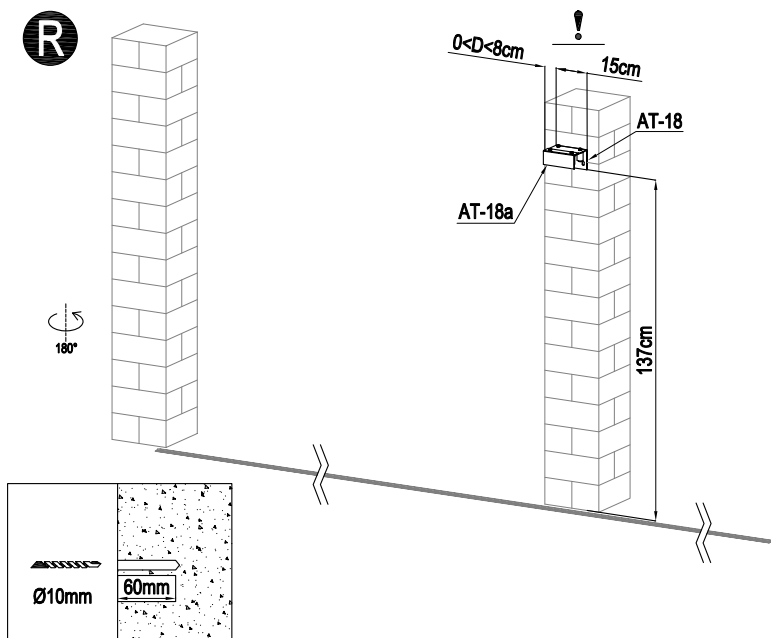

	AT-18	1
	AT-18a	1
	AT-20	4
	DO-H33	3

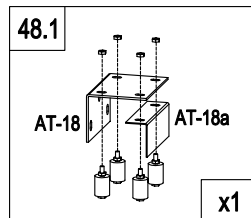
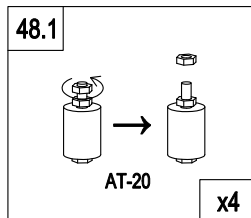

R

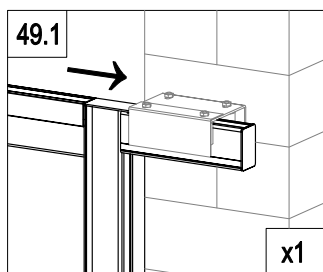
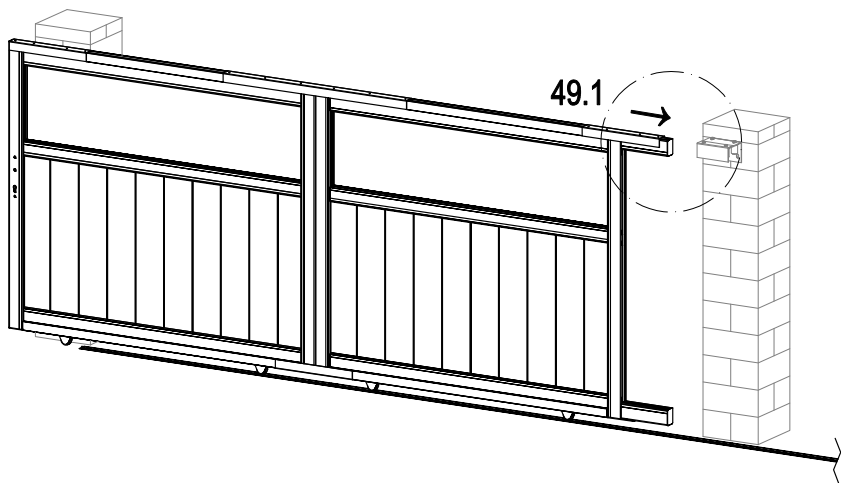

R

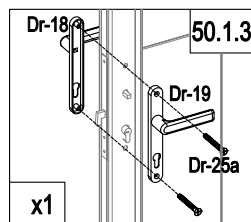
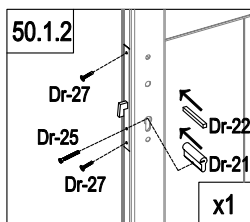
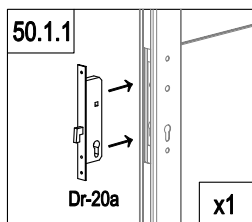
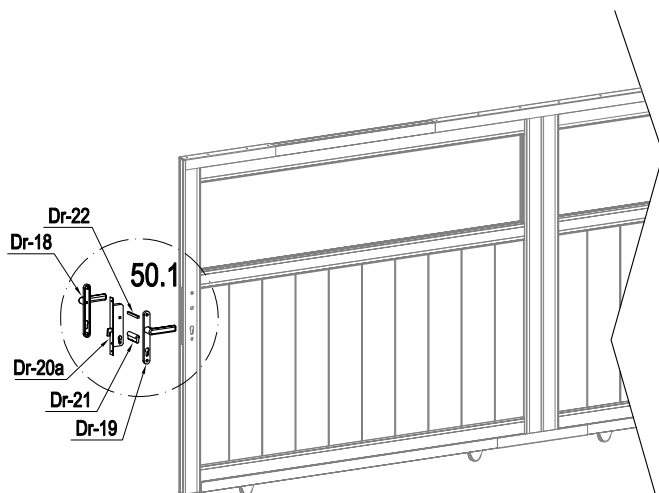

	Dr-20a	1
	Dr-21	1
	Dr-22	1
	Dr-25	1

	Dr-18	1
	Dr-19	1
	Dr-25a	2
	Dr-27	2

R

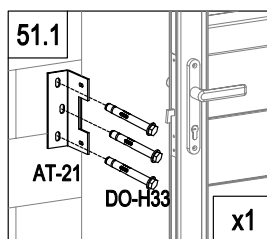
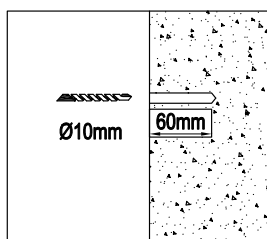
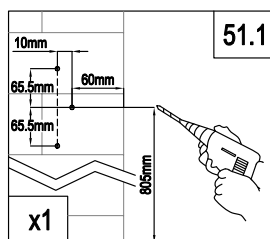
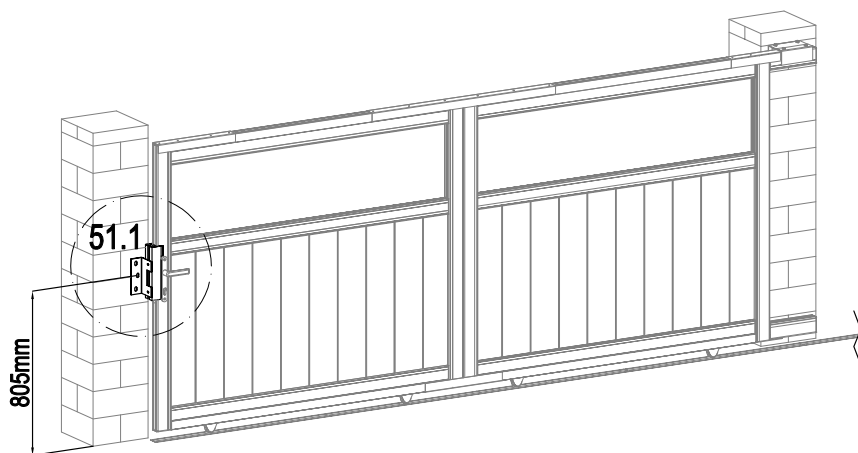

	AT-16	1
	AT-21	1
	DO-H36	2
	DO-H33	3
	AT-22J	3

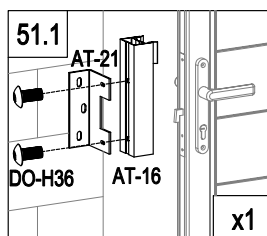
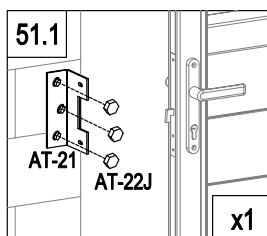

R

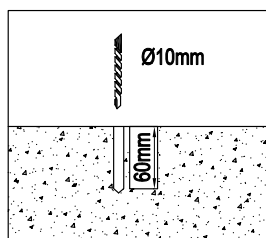
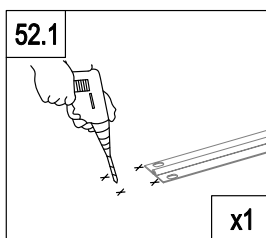
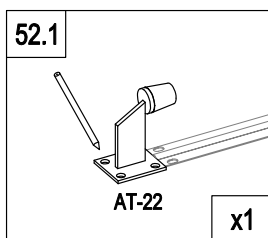
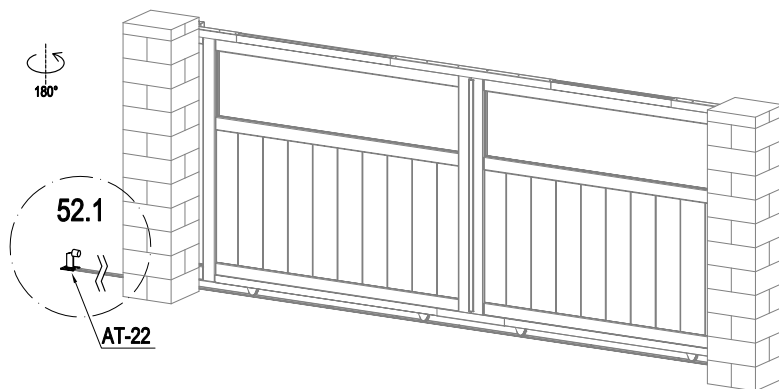

	AT-22	1
	DO-H33	4
	AT-22J	4

