

CASANOVO

Do 100P140

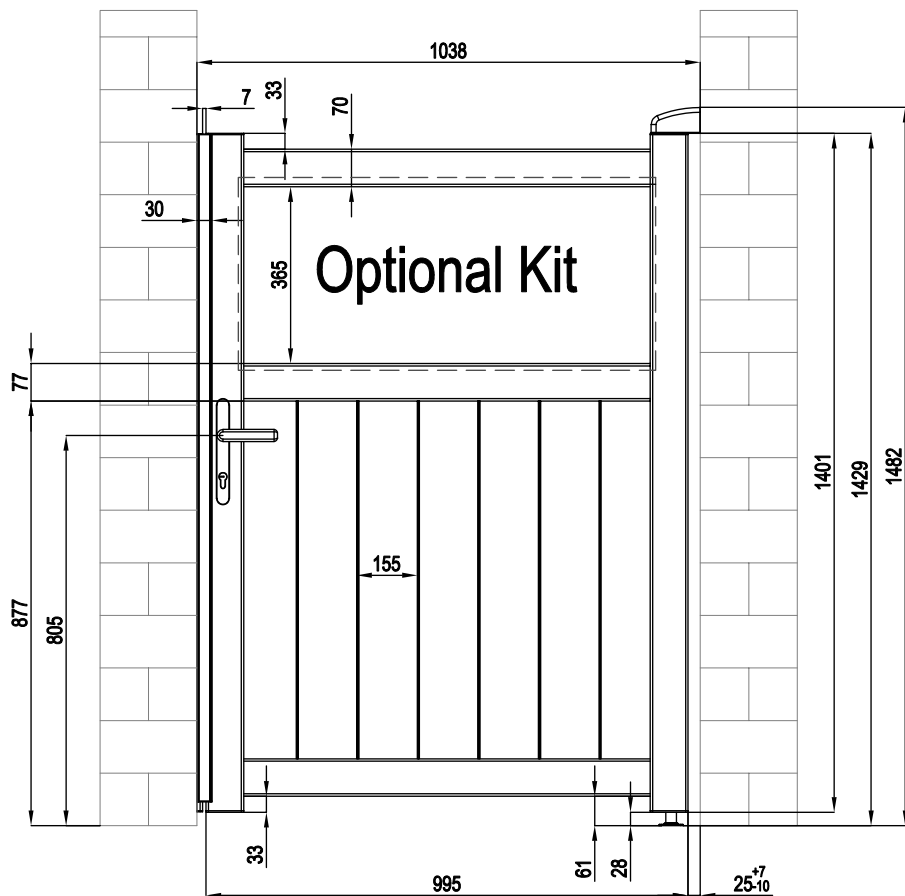





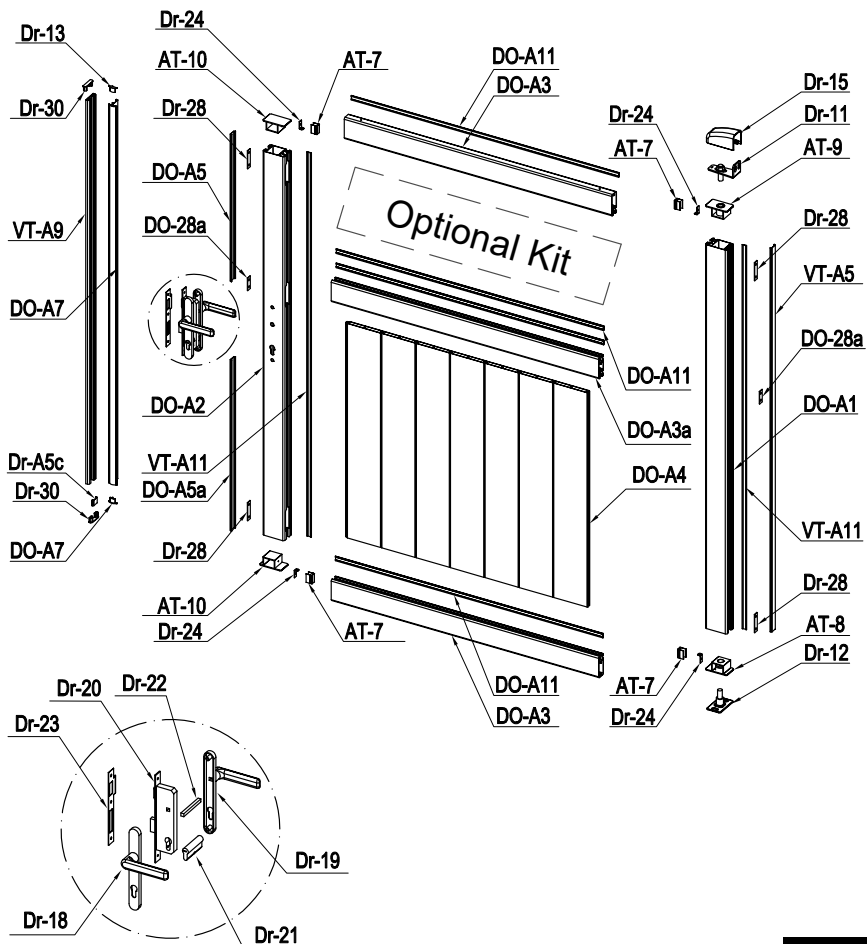
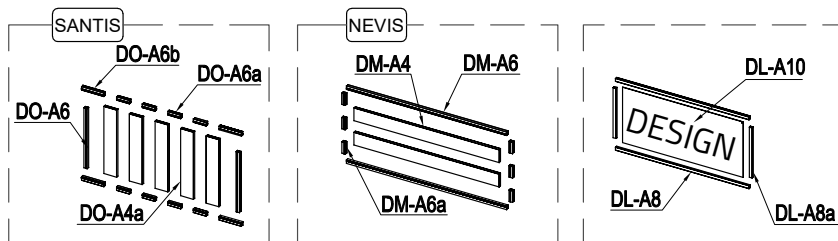



































INSTRUCTION MANUAL / NOTICE DE MONTAGE / MONTAGEANLEITUNG / MANUAL DE MONTAJE / MANUAL DE MONTAGEM / MANUALE DI MONTAGGIO /
MONTAGEHANDLEIDING / INSTRUKCJA MONTAŻU / KÄYTTÖOHJEET / BRUKSANVISNING / BRUGSANVISNING / INSTRUCȚIUNI DE ASAMBLARE /
NAVODILA ZA SESTAVLJANJE / NÁVOD NA MONTÁŽ / ÖSSZESZERELÉSI ÚTMUTATÓ / NÁVOD K MONTÁŽI / UPUTE ZA INSTALACIJU /
ΟΔΗΓΙΕΣ ΣΥΝΑΡΜΟΛΟΓΗΣΗΣ / SURINKIMO INSTRUKCIJOS / MONTĀŽAS INSTRUKCIJAS

















PART LIST

IMAGE	NO.	L.(mm)	QTY	IMAGE	NO.	L.(mm)	QTY
	DO-A1	1395	1		DO-30		4
	DO-A2	1395	1			Dr-18	
	DO-A3	972	2		Dr-19		1
	DO-A3a	972	1		Dr-20		1
	DO-A4	779	7		Dr-21		1
	VT-A5	1395	1		Dr-22		1
	DO-A5	532.5	1		Dr-23		1
	DO-A5a	622	1		Dr-25		1
	Dr-A5c	19.5	1		Dr-25a		2
	VT-A11	1395	2		Dr-26		3
	DO-A11	972	4		Dr-27		2
	AT-7	29.5	4		Dr-24		4
	DO-A7	1375	1		Dr-28		4
	VT-A9	1395	1		DO-28a		2
	DO-A15	970	1		DO-AA30	ST4x10	4
	AT-8		1		DO-AA31	ST5.5x38	12
	AT-9		1		DO-AA32	ST4.8x38	6
	AT-10		2		DO-AA33	M8x60	6
	Dr-11		1		DO-AA34	M6x50	3
	Dr-12		1		DO-AA35	ST4.2x13	18
	Dr-13		1				
	Dr-14		1				
	Dr-15		1				
	Dr-17		1				
	Dr-30		2				
	Dr-31		2				



PARTS LIST (Optional Kit)

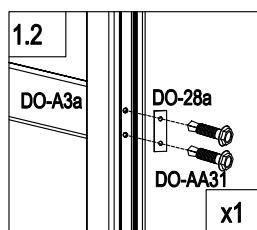
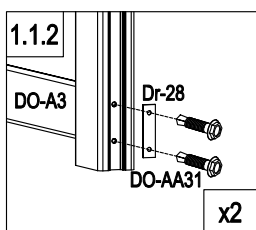
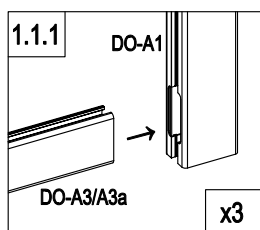
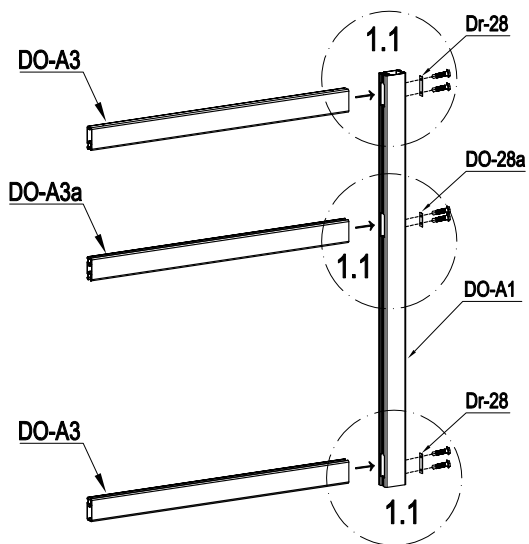

	IMAGE	NO.	L.(mm)	QTY
		DO-A4a	406	5
		DO-A6	364	2
		DO-A6a	163	4
		DO-A6b	77.5	8
	DO-35		10	

	IMAGE	NO.	L.(mm)	QTY
		DM-A4	970	2
		DM-A6	879	2
		DM-A6a	69	6
		DO-32		4

	IMAGE	NO.	L.(mm)	QTY
		DL-A8	970	2
		DL-A8a	364	2
		DL-A10	877	1
		DO-32		4
		DO-35		6



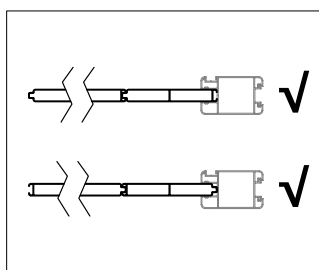
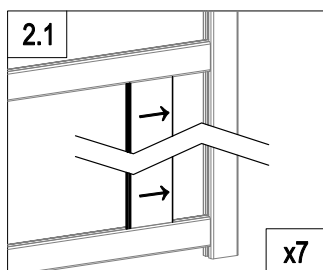
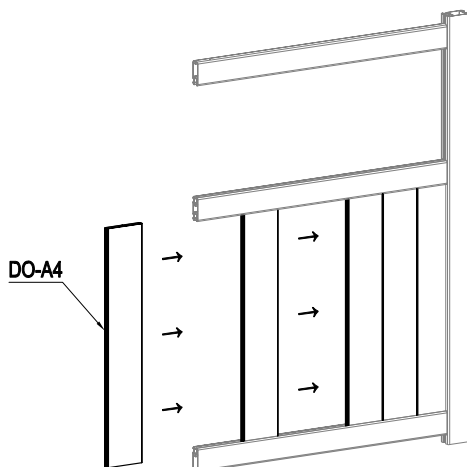

	DO-A1	1
	DO-A3	2
	DO-A3a	1

	Dr-28	2
	DO-28a	1
	DO-AA31	6

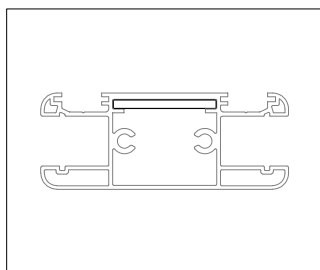
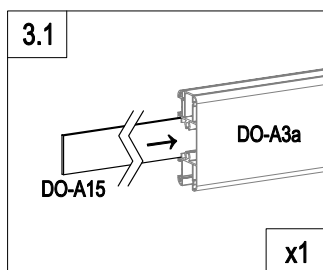
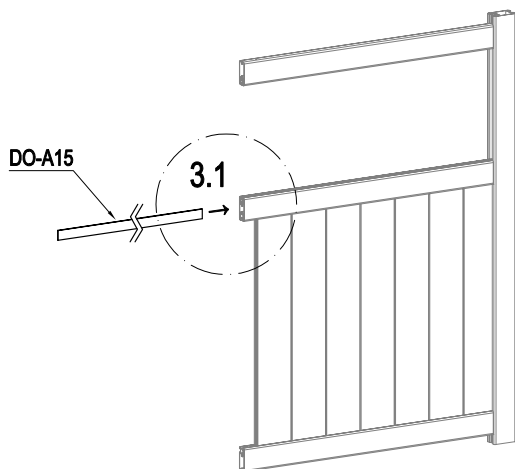

	DO-A4	7
---	-------	---



	DO-A15	1
---	--------	---

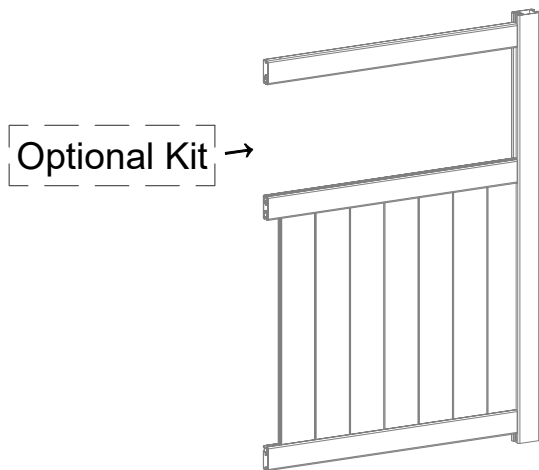

P 10~13





P 14~17

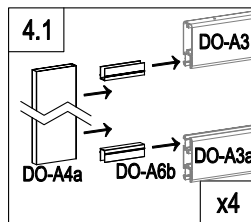
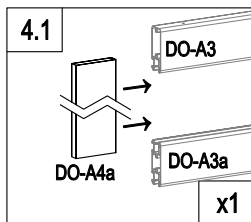
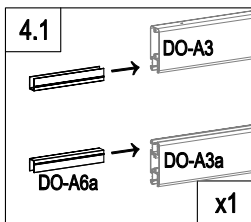
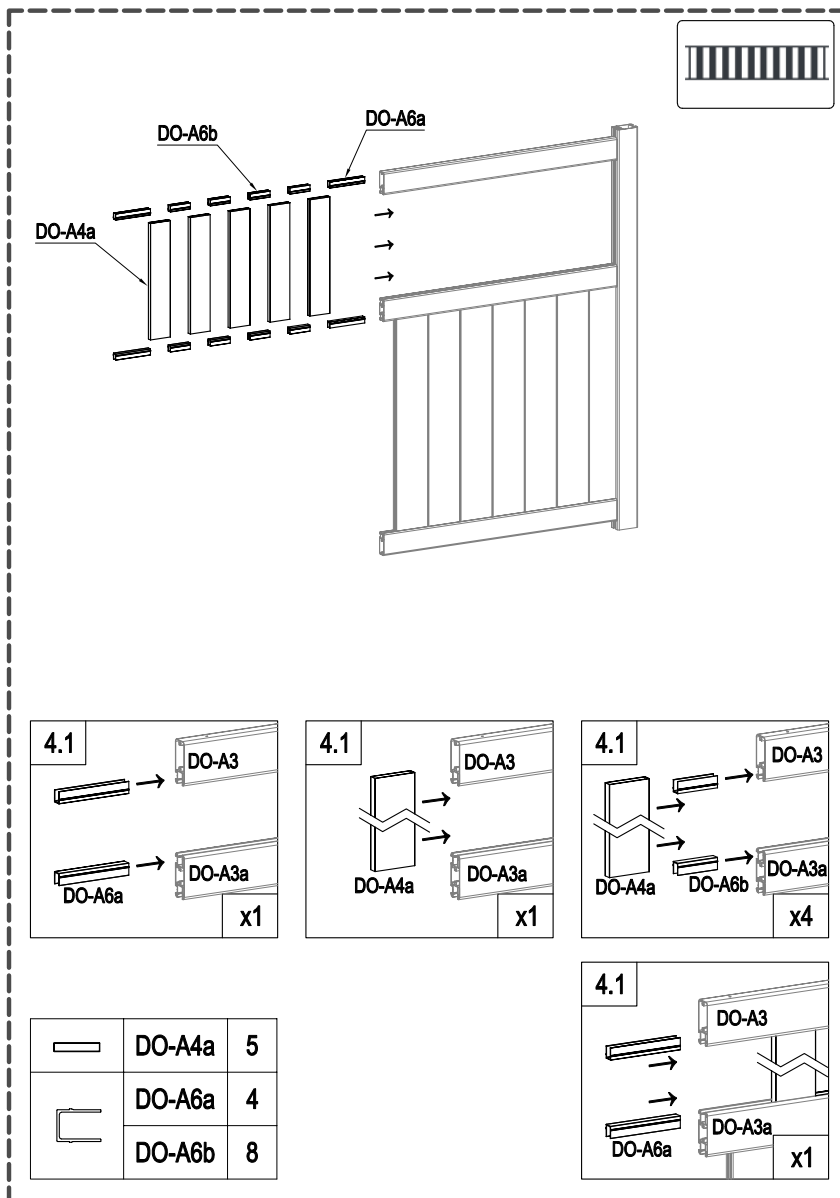

P 18~20



	DO-A4a	5
	DO-A6a	4
	DO-A6b	8

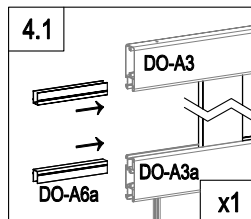

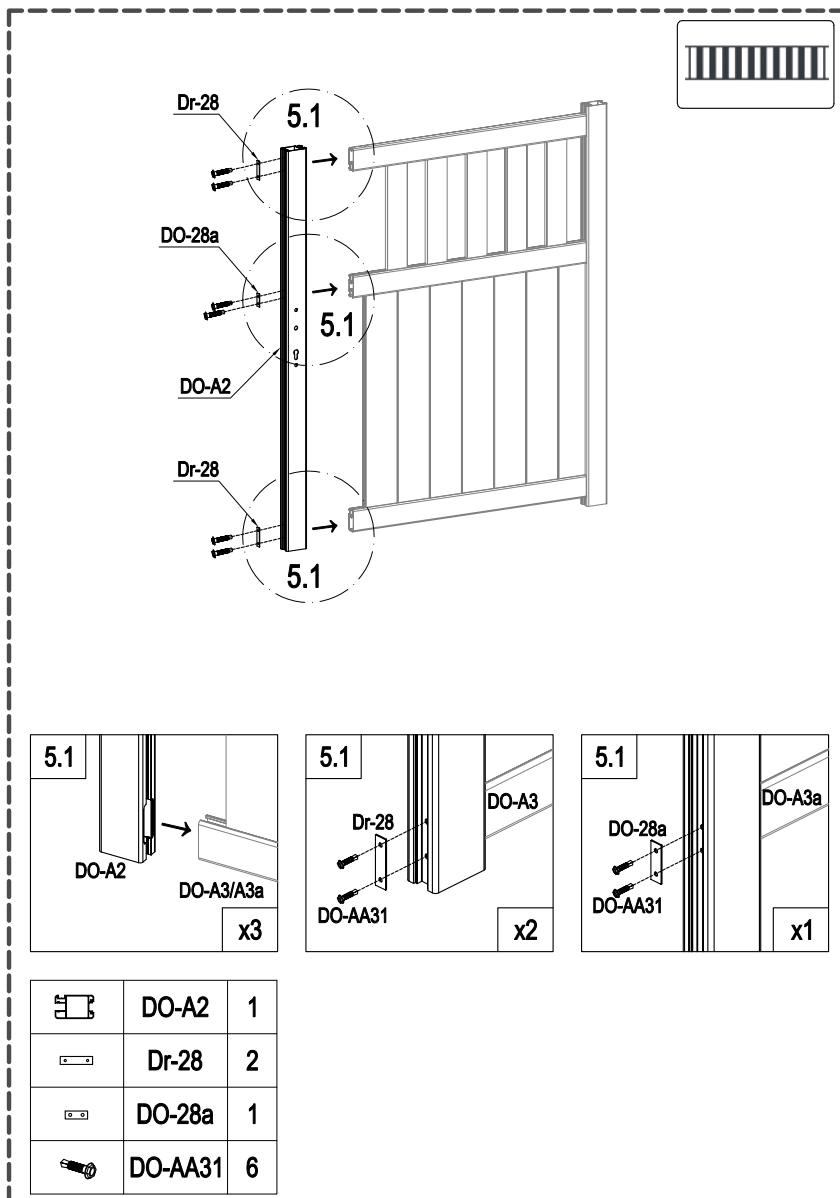

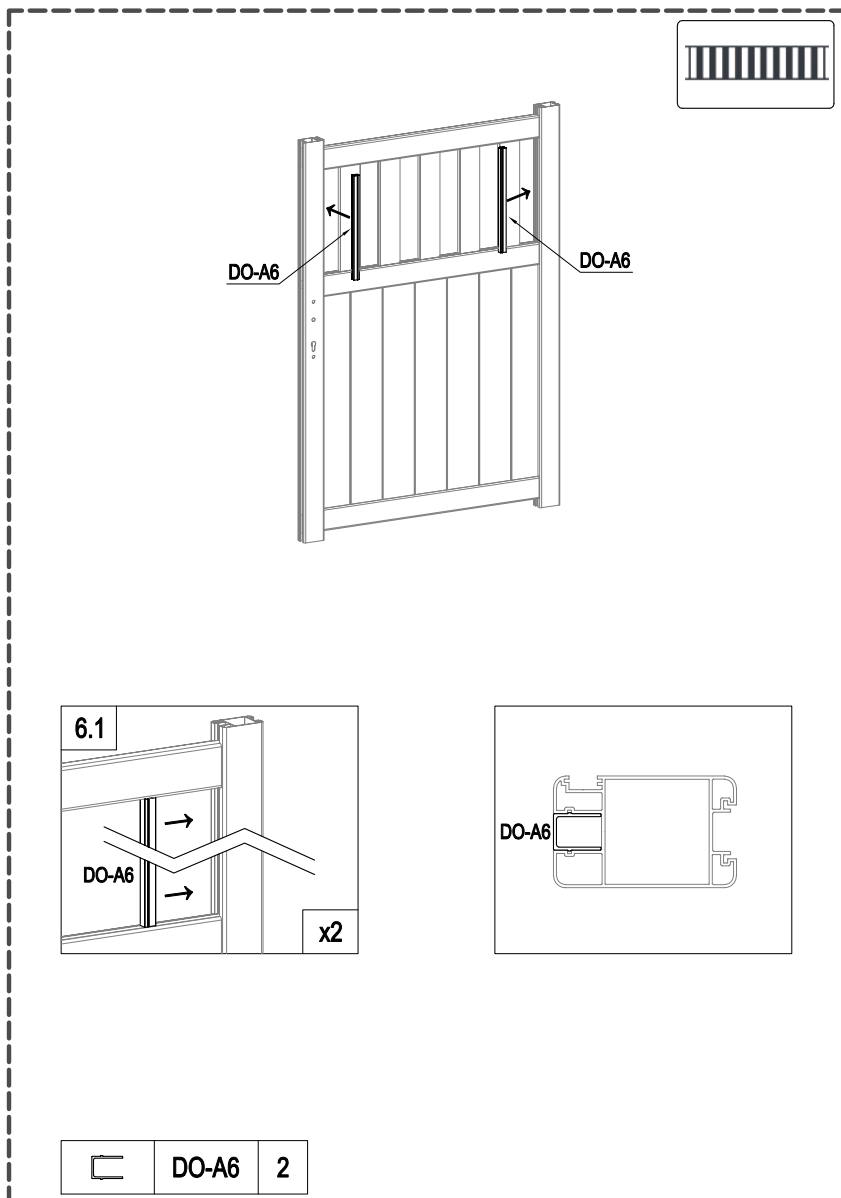

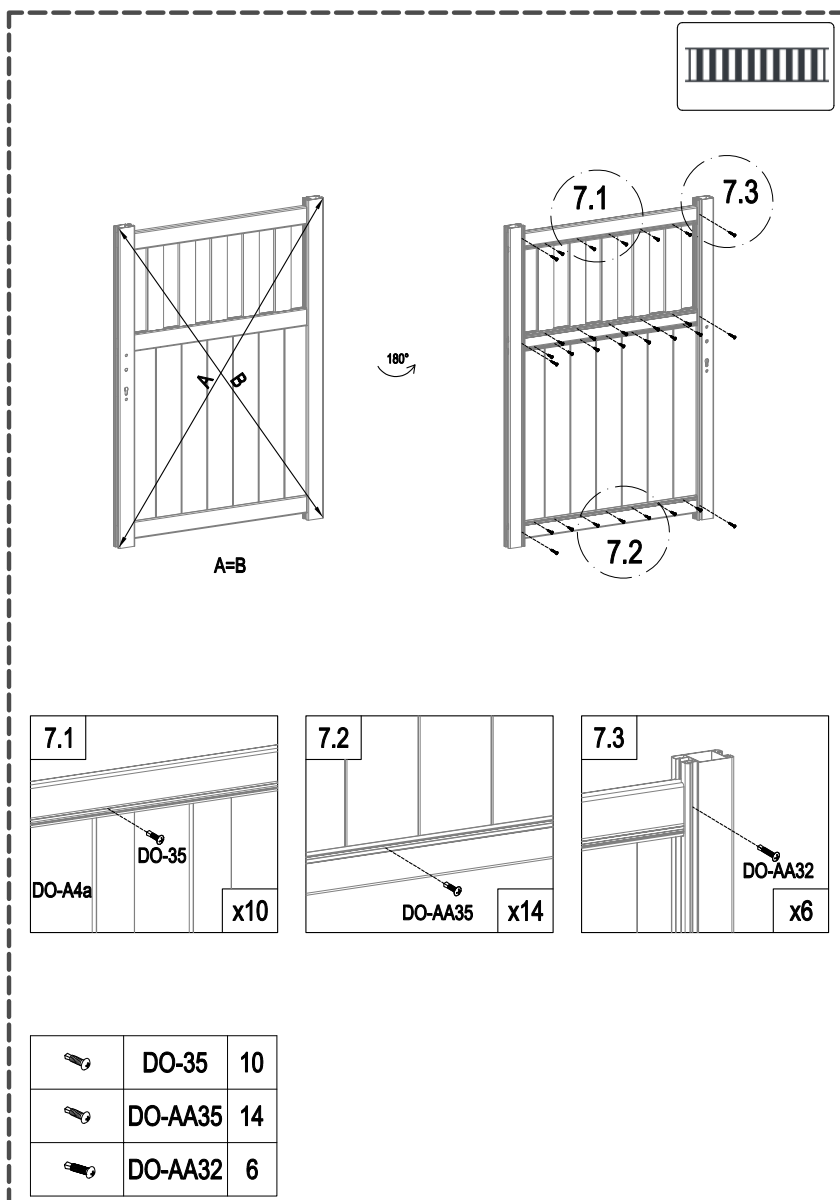

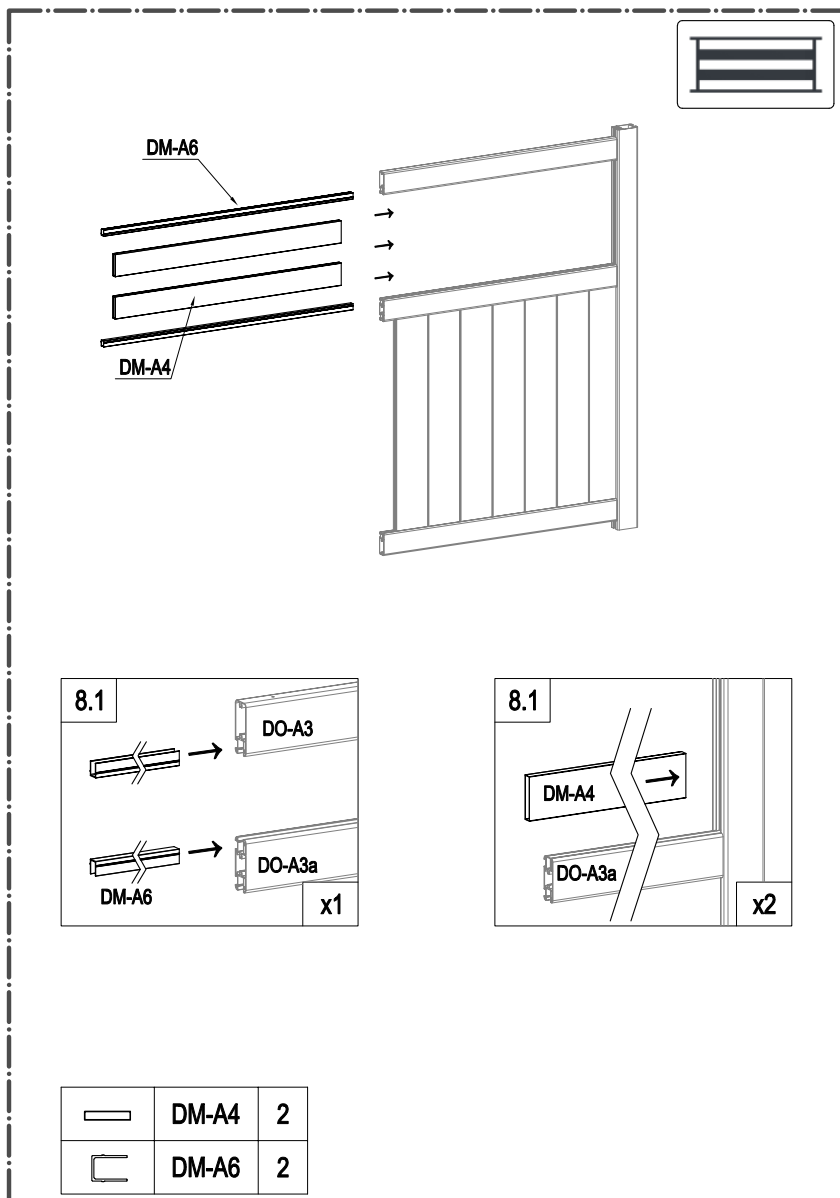

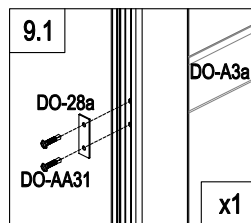
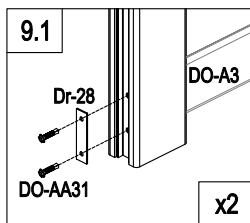
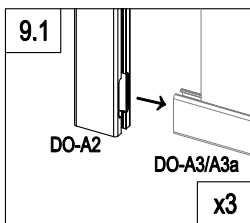
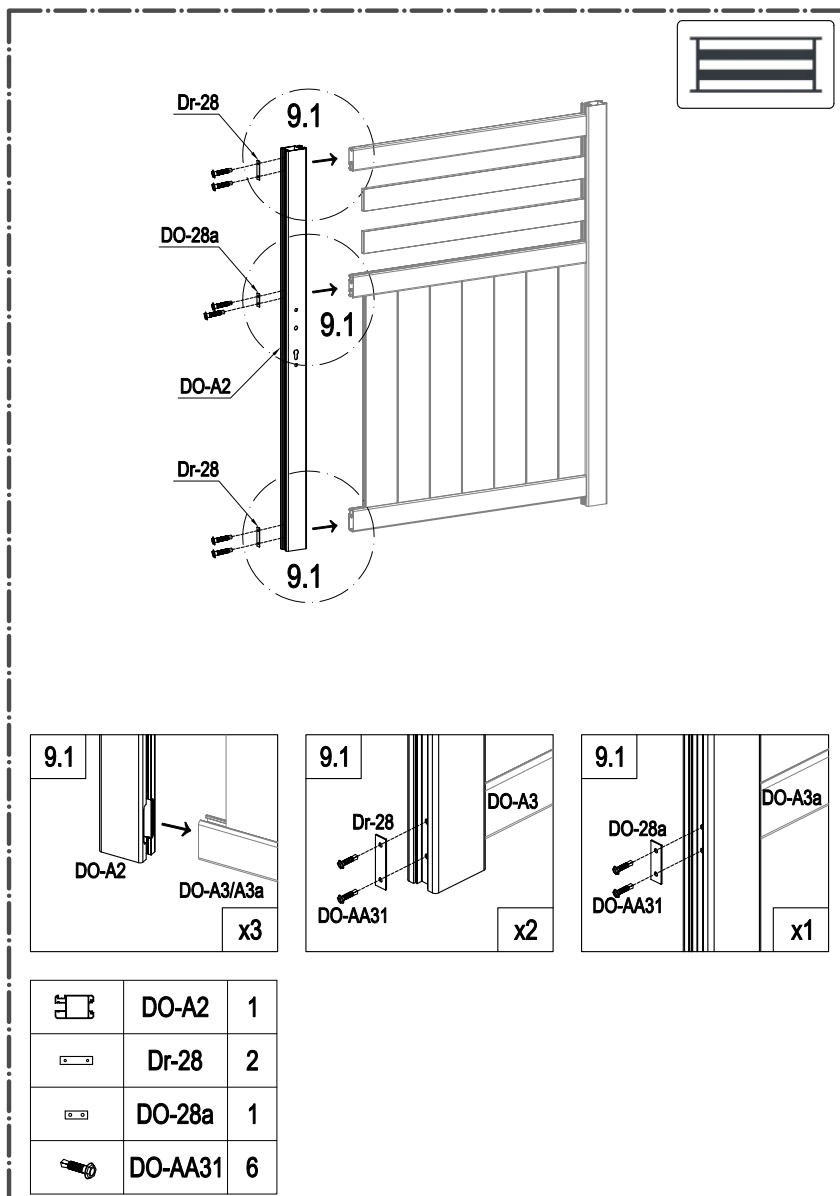



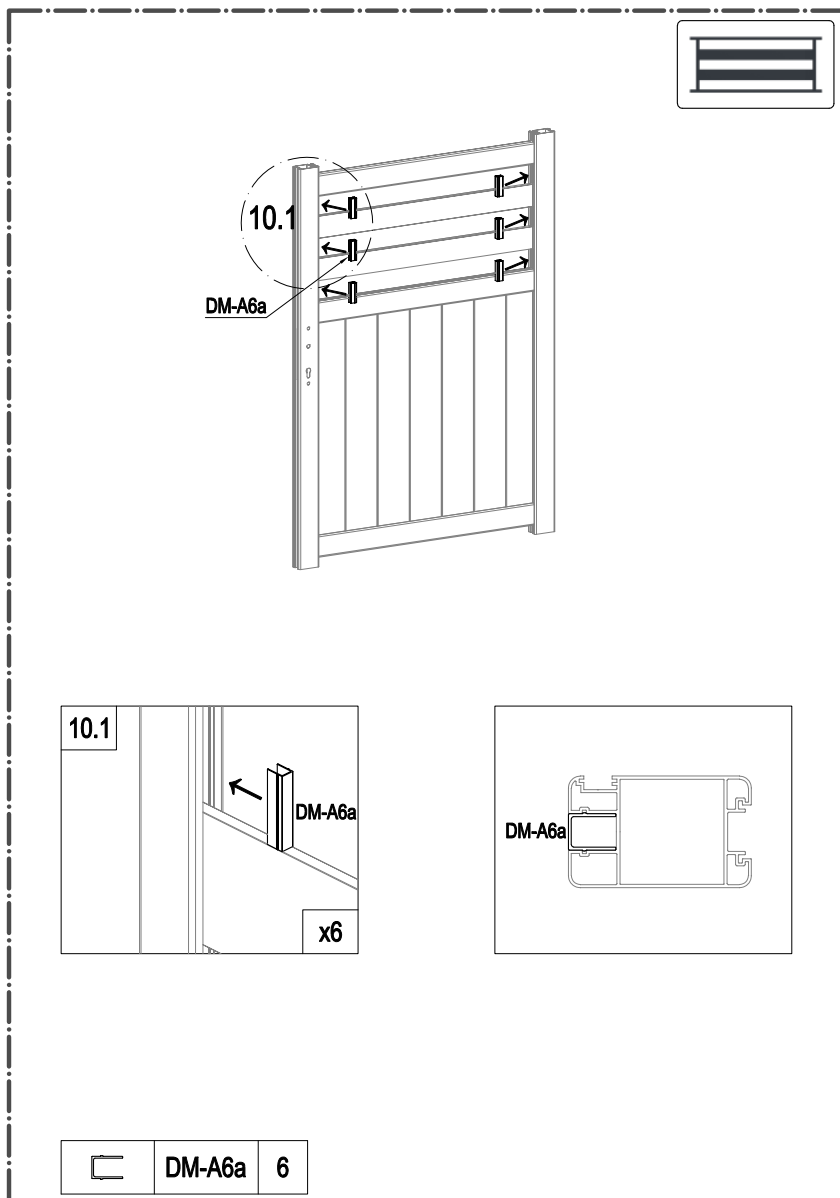

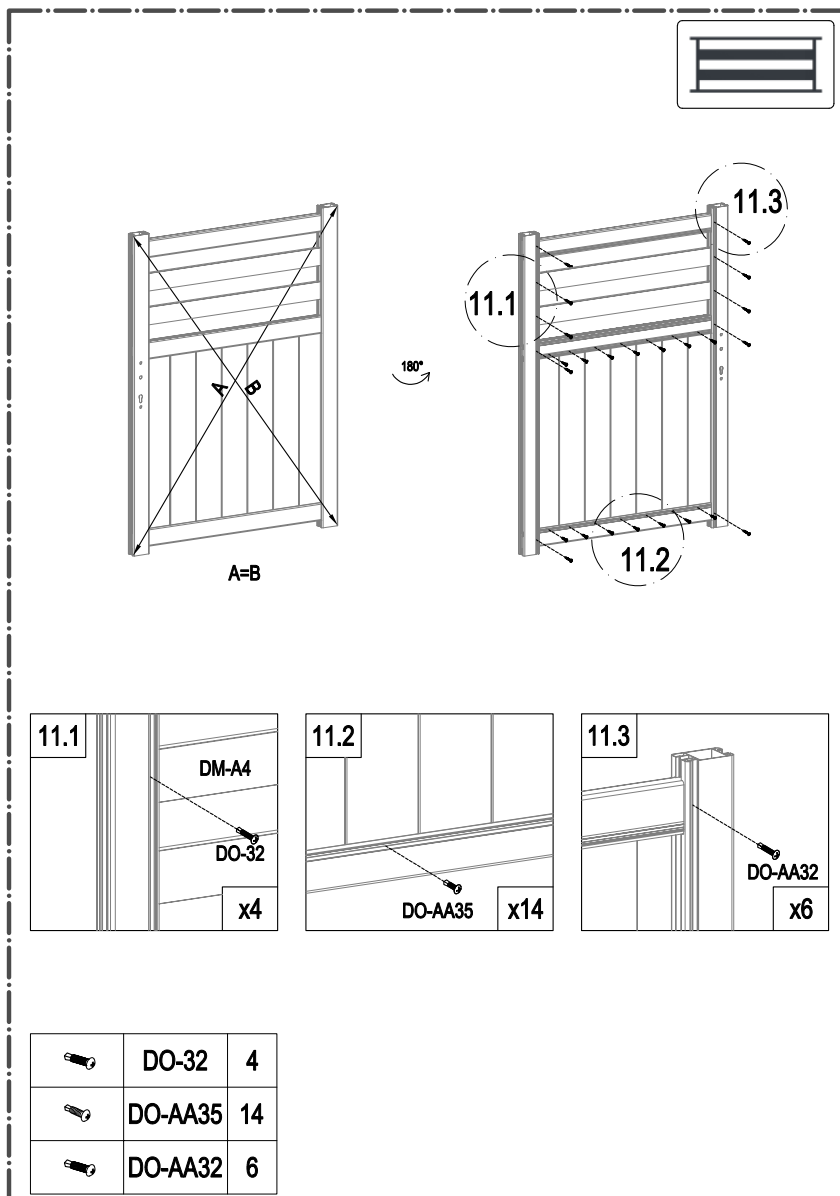
	DO-A2	1
	Dr-28	2
	DO-28a	1
	DO-AA31	6







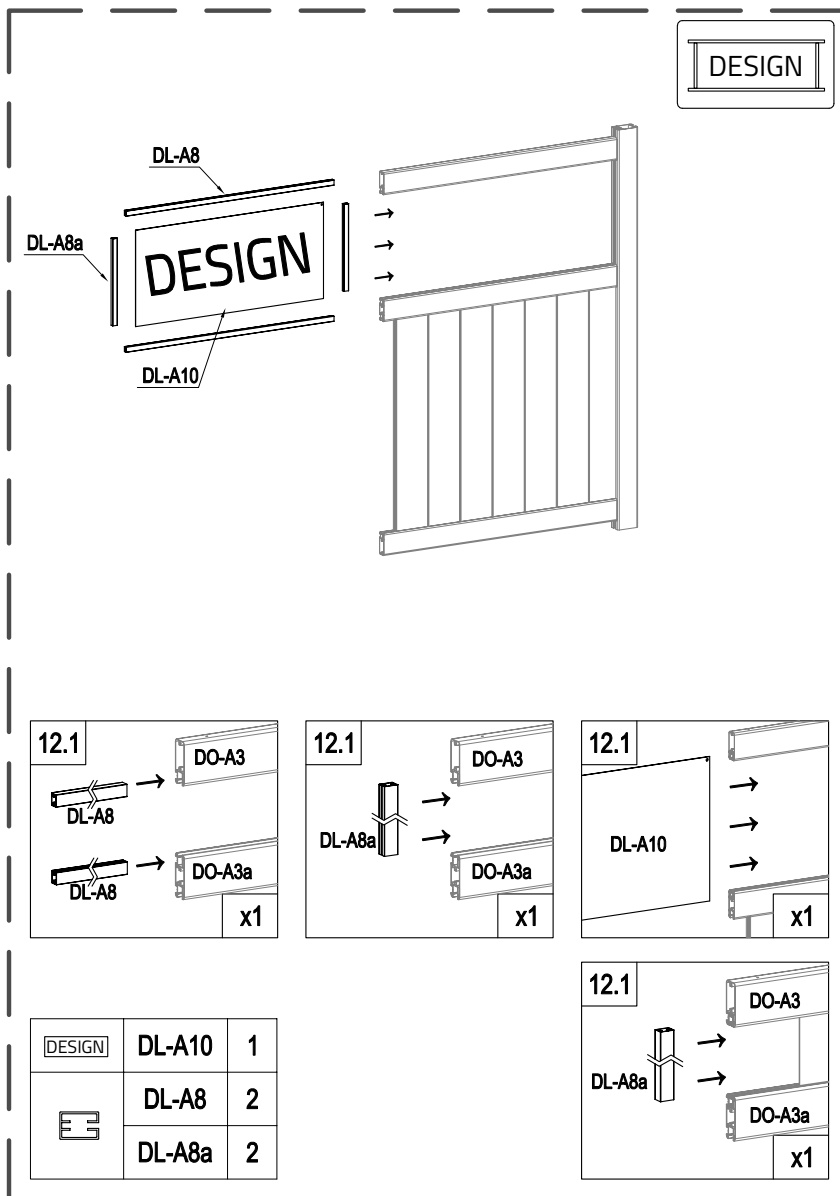

	DO-32	4
	DO-AA35	14
	DO-AA32	6

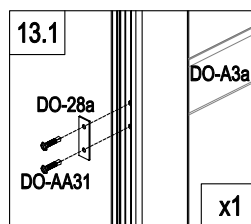
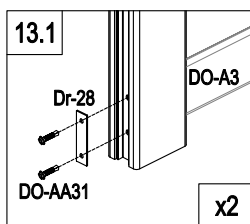
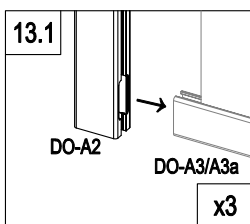
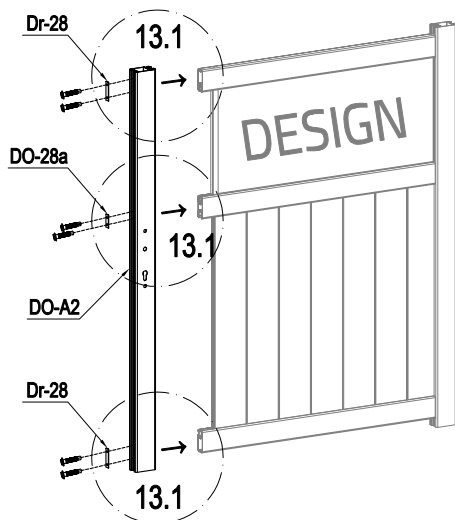

DESIGN



	DO-A2	1
	Dr-28	2
	DO-28a	1
	DO-AA31	6

DESIGN

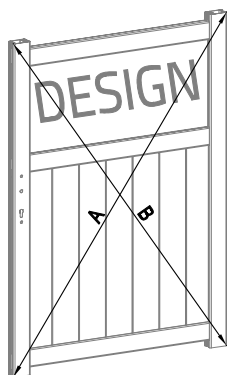

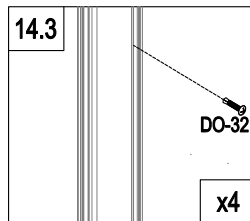
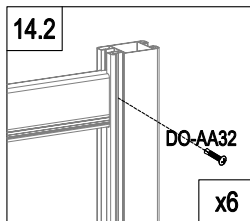
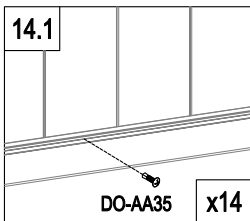
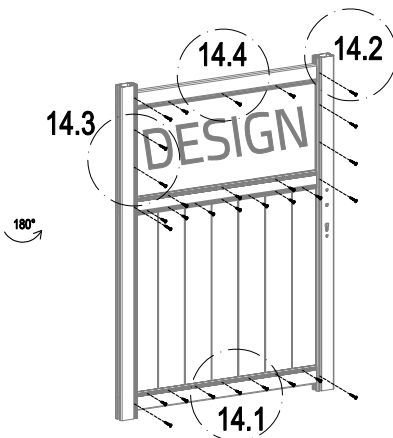

A=B



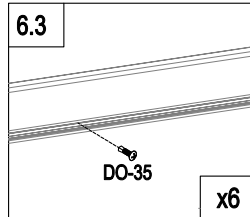

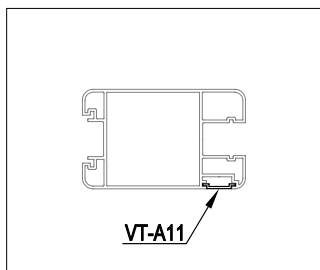
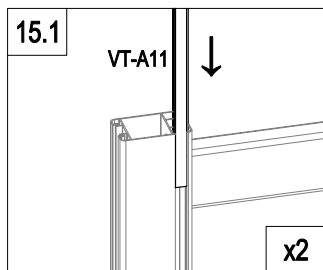
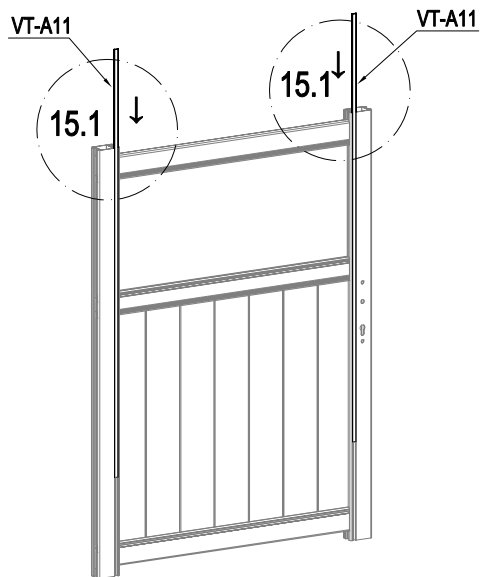
	DO-35	6
	DO-32	4
	DO-AA35	14
	DO-AA32	6



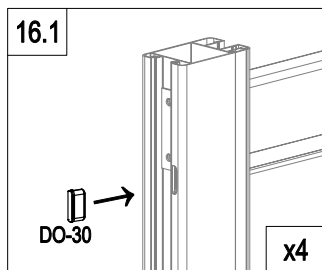
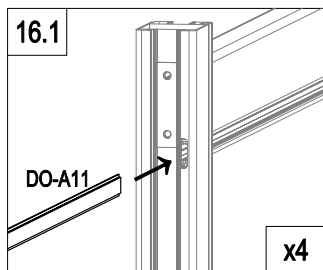
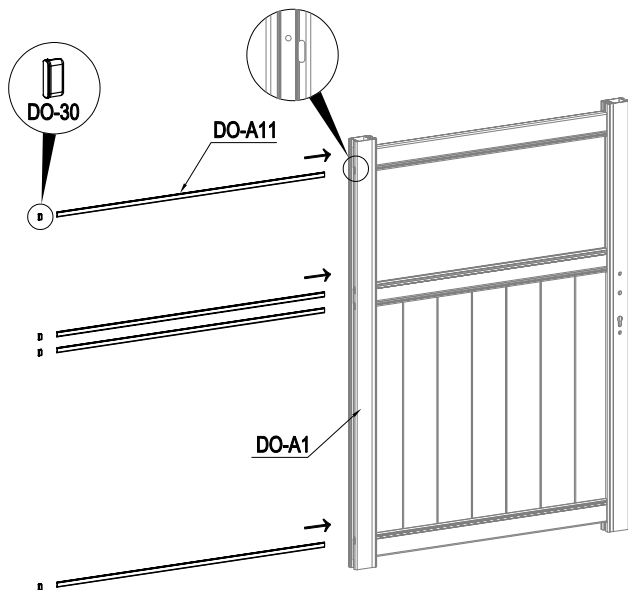

	VT-A11	2
---	--------	---



	DO-A11	4
	DO-30	4

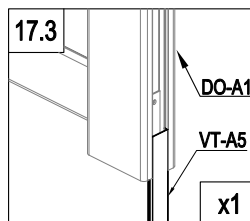
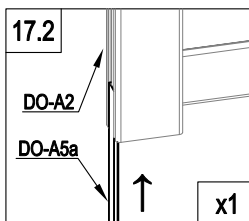
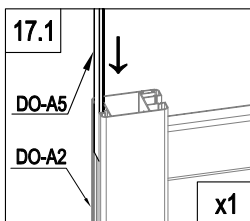
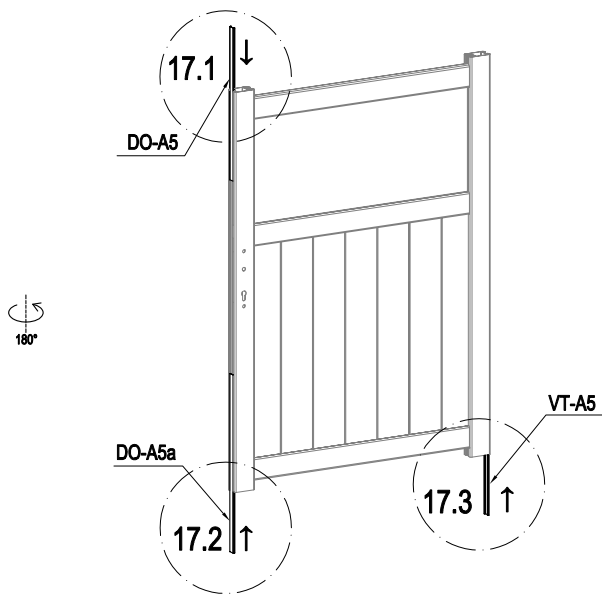

	VT-A5	1
	DO-A5	1
	DO-A5a	1

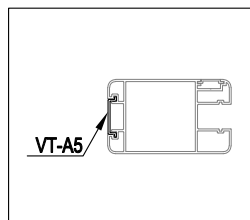

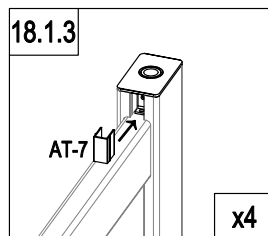
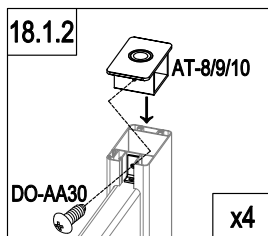
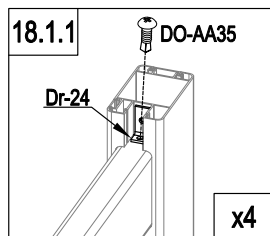
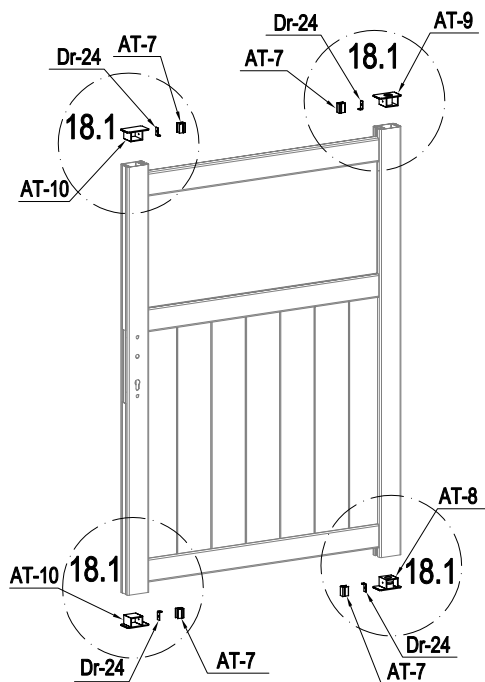

	AT-8	1
	AT-9	1
	AT-10	2
	Dr-24	4

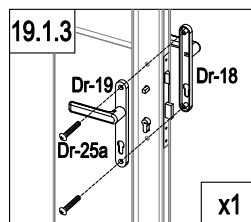
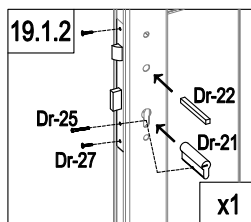
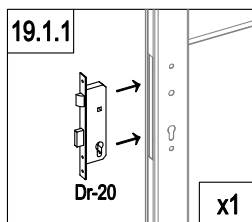
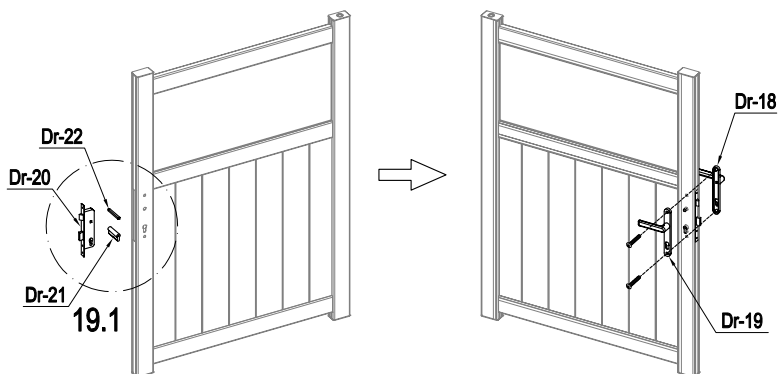

	AT-7	4
	DO-AA30	4
	DO-AA35	4

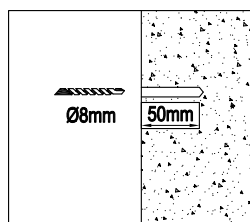
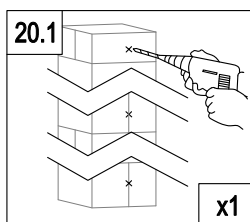
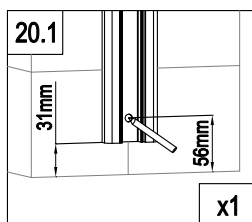
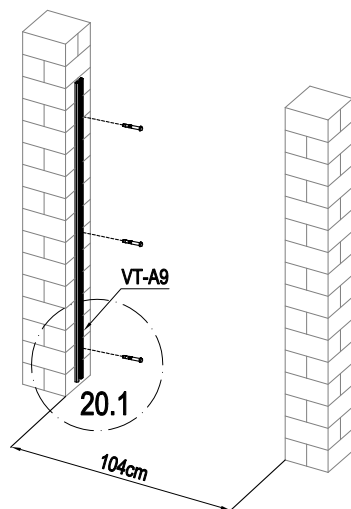

	Dr-20	1
	Dr-21	1
	Dr-22	1
	Dr-25	1

	Dr-18	1
	Dr-19	1
	Dr-25a	2
	Dr-27	2



	VT-A9	1
	DO-AA34	3

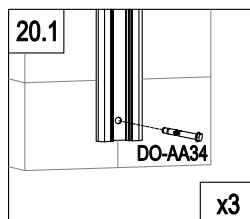

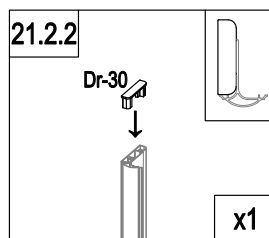
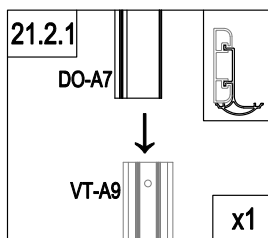
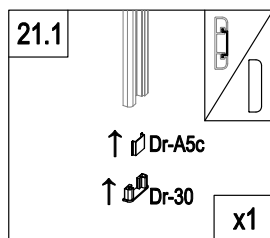
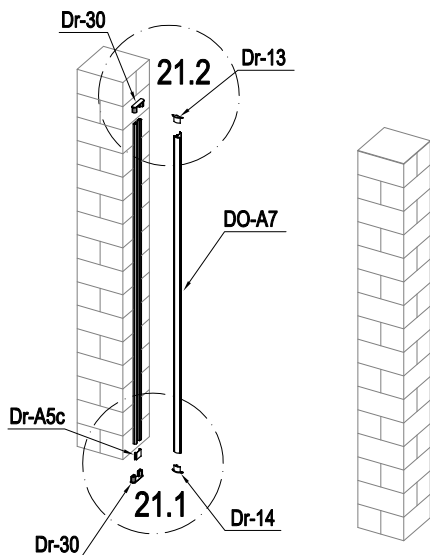

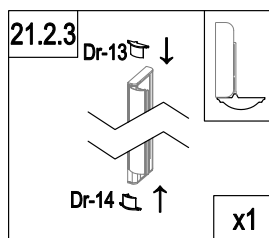

	DO-A7	1
	Dr-13	1
	Dr-14	1
	Dr-30	2
	Dr-A5c	1

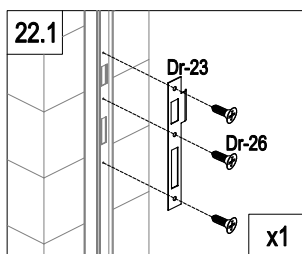
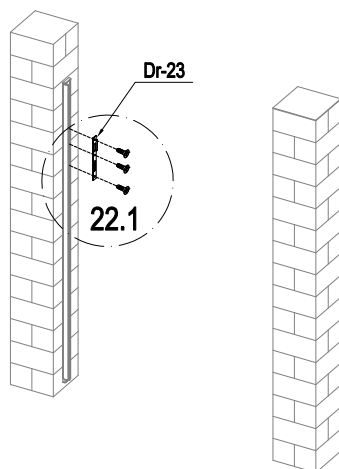



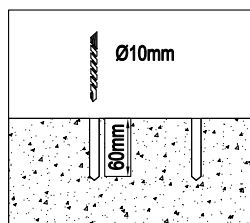
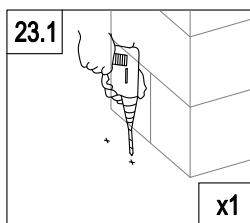
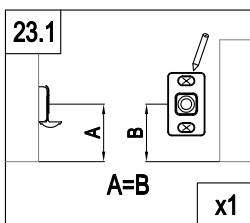
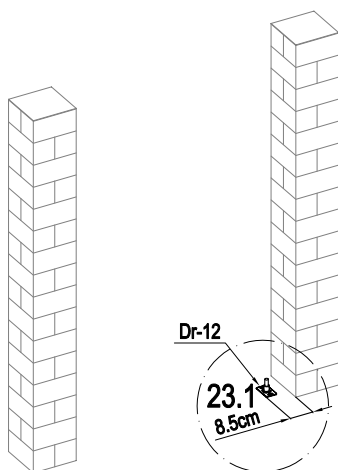

	Dr-23	1
	Dr-26	3

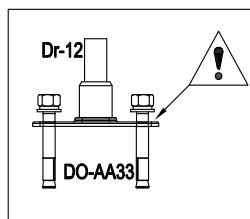
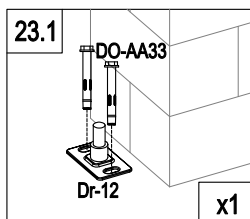

	Dr-12	1
	DO-AA33	2

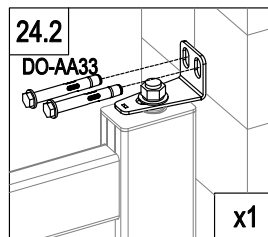
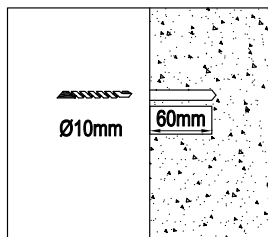
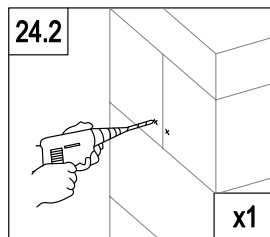
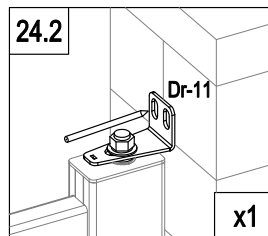
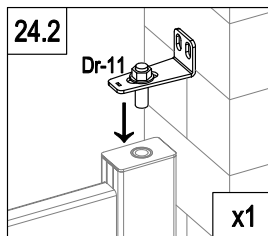
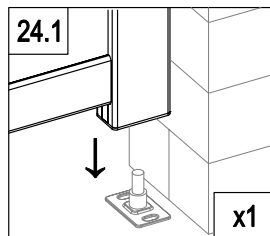
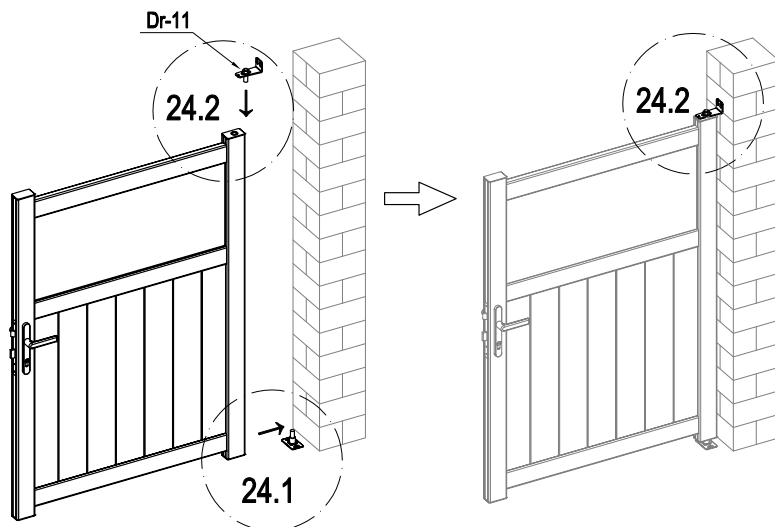





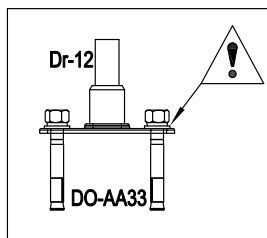
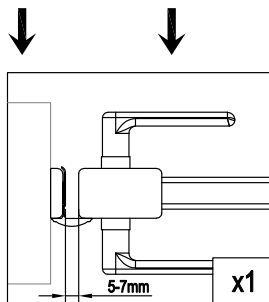
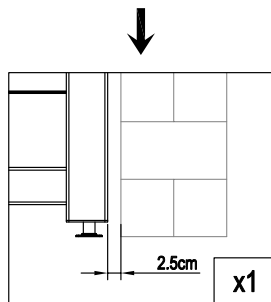
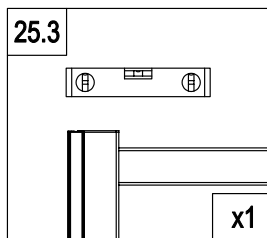
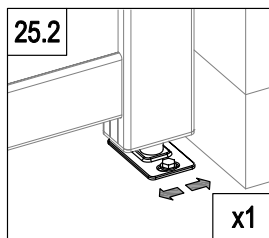
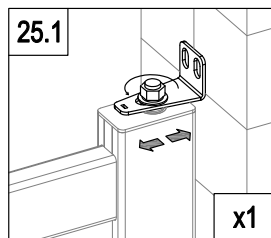
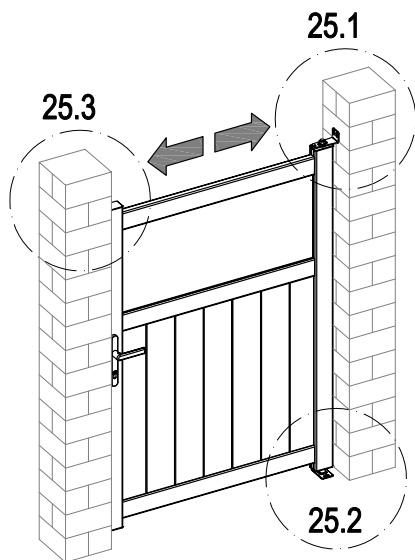

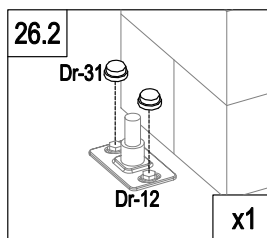
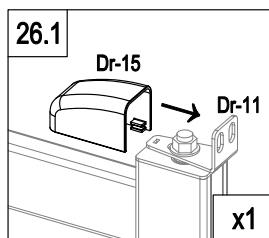
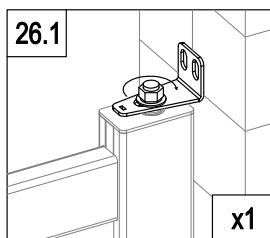
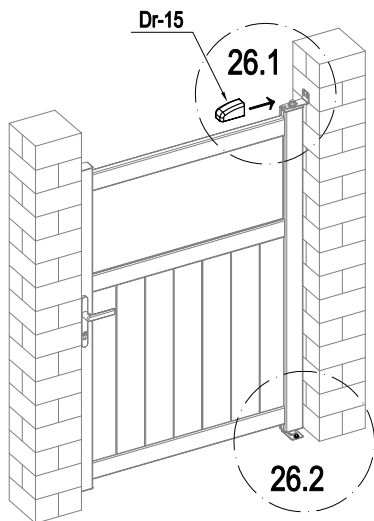
	Dr-11	1
	DO-AA33	2



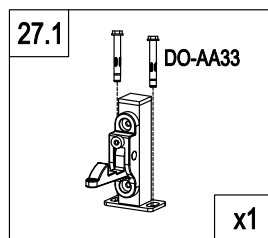
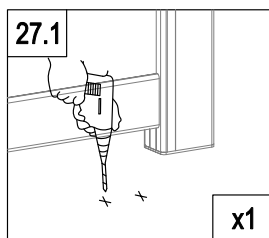
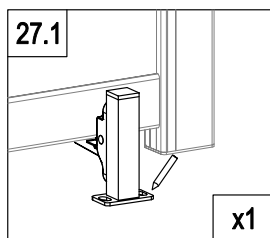
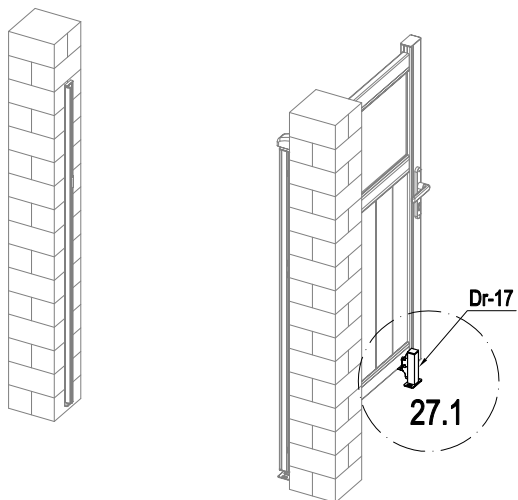

	Dr-15	1
	Dr-31	2



	DO-AA33	2
	Dr-17	1