

CASANOVO

CERVINA 350B140

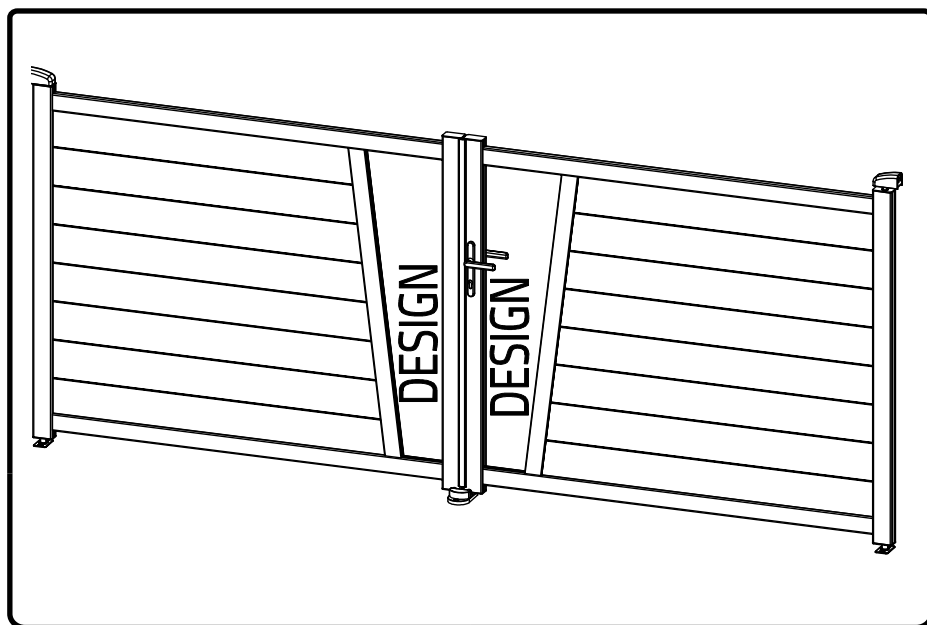

7-8H



X 2

EN FR DE ES PT IT NL PL FI SE DK
RO SI SK HU CZ HR GR LT LV



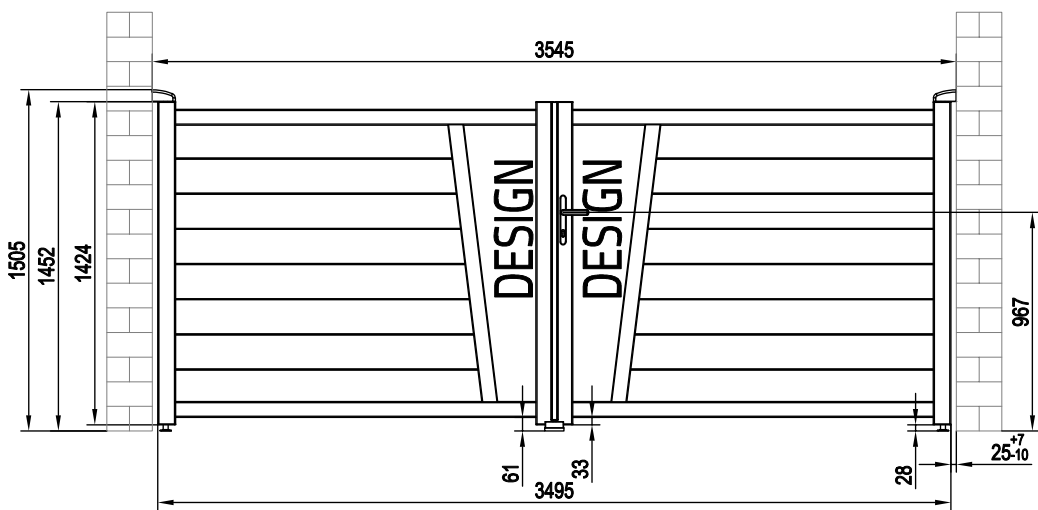

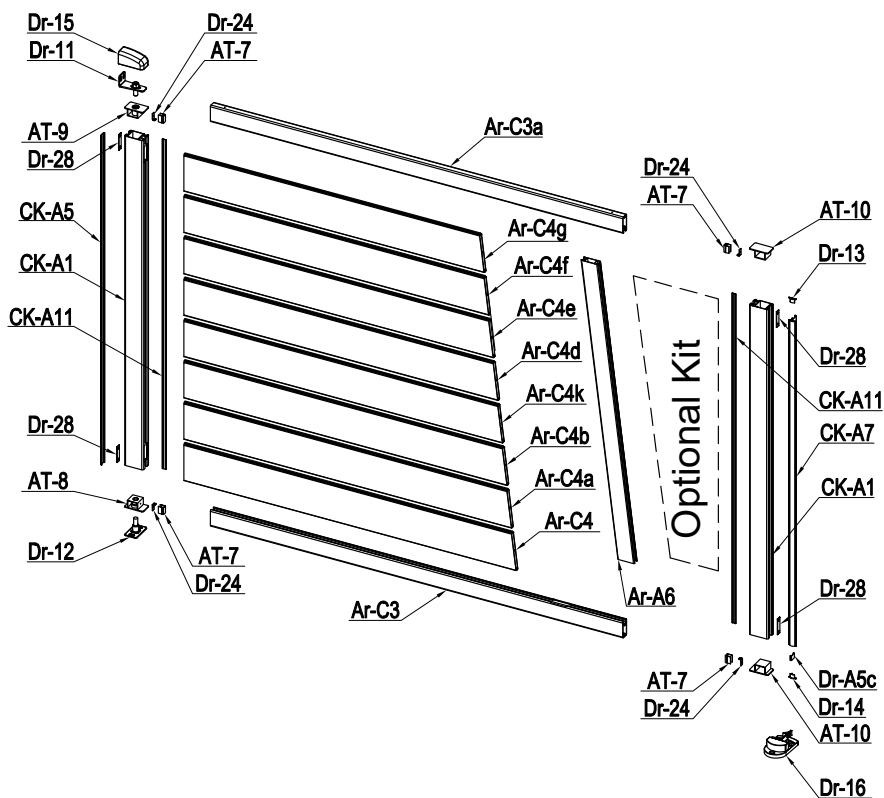

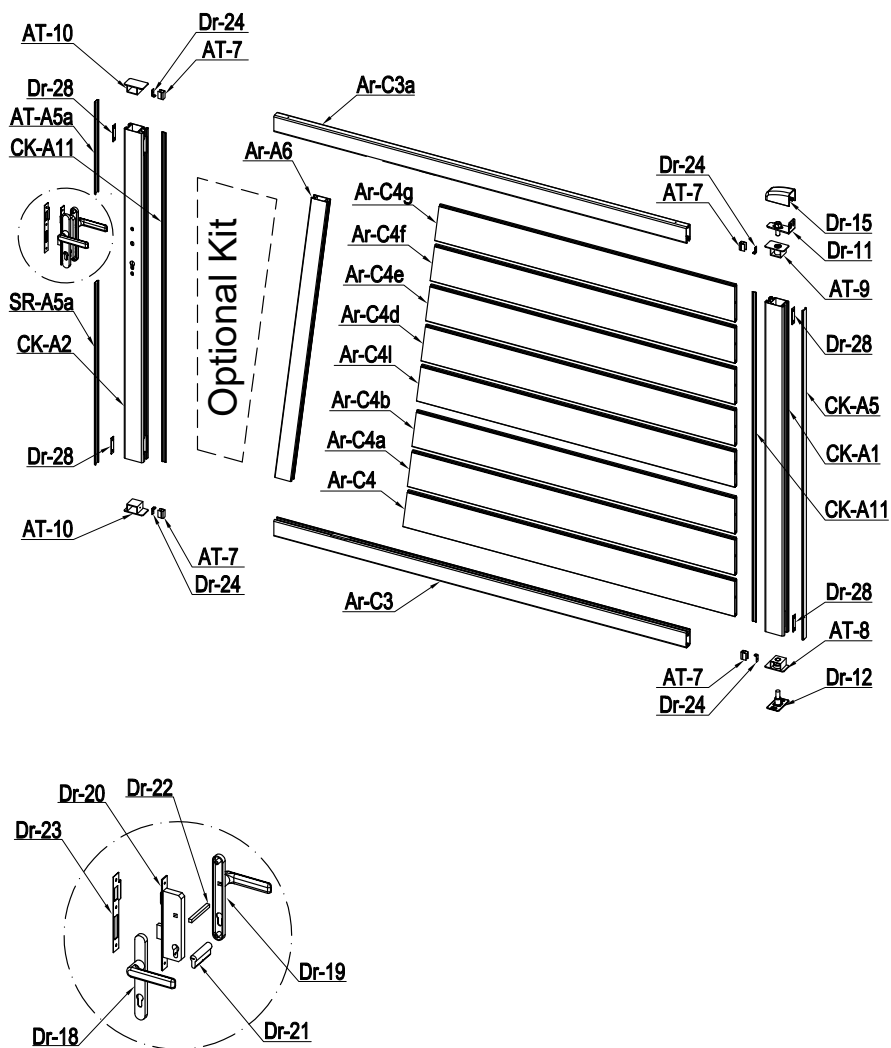

































INSTRUCTION MANUAL / NOTICE DE MONTAGE / MONTAGEANLEITUNG / MANUAL DE MONTAJE / MANUAL DE MONTAGEM / MANUALE DI MONTAGGIO /
MONTAGEHANDLEIDING / INSTRUKCJA MONTAŻU / KÄYTTÖOHJEET / BRUKSANVISNING / BRUGSANVISNING / INSTRUCȚIUNI DE ASAMBLARE /
NAVODILA ZA SESTAVLJANJE / NÁVOD NA MONTÁŽ / ÖSSZESZERELÉSI ÚTMUTATÓ / NÁVOD K MONTÁŽI / UPUTE ZA INSTALACIJU /
ΟΔΗΓΙΕΣ ΣΥΝΑΡΜΟΛΟΓΗΣΗΣ / SURINKIMO INSTRUKCIJOS / MONTĀŽAS INSTRUKCIJAS







PART LIST

IMAGE	NO.	L.(mm)	QTY	IMAGE	NO.	L.(mm)	QTY
	CK-A1	1418	3		Dr-14		1
	CK-A2	1418	1		Dr-15		2
	Ar-C3	1721	2		Dr-16		1
	Ar-C3a	1721	2		Dr-17		2
	Ar-A6	1263	2		Dr-31		4
	Ar-C4	1386	2		Dr-18		1
	Ar-C4a	1367	2		Dr-19		1
	Ar-C4b	1348	2		Dr-20		1
	Ar-C4d	1310	2		Dr-21		1
	Ar-C4e	1291	2		Dr-22		1
	Ar-C4f	1272	2		Dr-23		1
	Ar-C4g	1253	2		Dr-25		1
	Ar-C4k (+Ar-C15) (1297)	1329 (1297)	1		Dr-25a		2
	Ar-C4l (+Ar-C15) (1297)	1329 (1297)	1		Dr-26		3
	CK-A5	1418	2		Dr-27		2
	AT-A5a	395.5	1		Dr-24		8
	SR-A5a	782	1		Dr-28		8
	Dr-A5c	19.5	1		Ar-G30	ST4x10	8
	CK-A11	1418	4		Ar-G31	ST4.2x13	8
	AT-7	29.5	8		Ar-G32	M8x60	12
	CK-A7	1398	1		Ar-G33	ST5.5x38	16
	AT-8		2		Ar-G34	ST6x40	3
	AT-9		2		Ar-G35	Ø6	3
	AT-10		4		Ar-G36	ST4.8x38	40
	Dr-11		2		Ar-G37	ST4.2x13	8
	Dr-12		2				
	Dr-13		1				

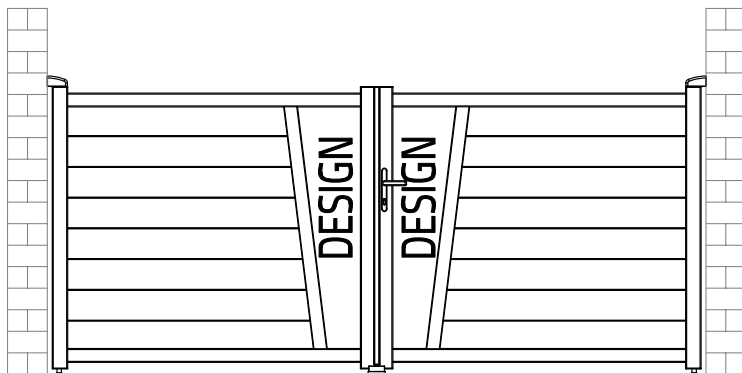

A

P: 9~41

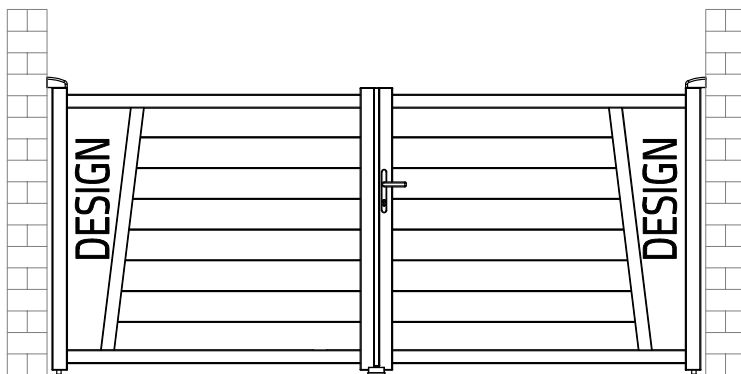

B

P: 42~74

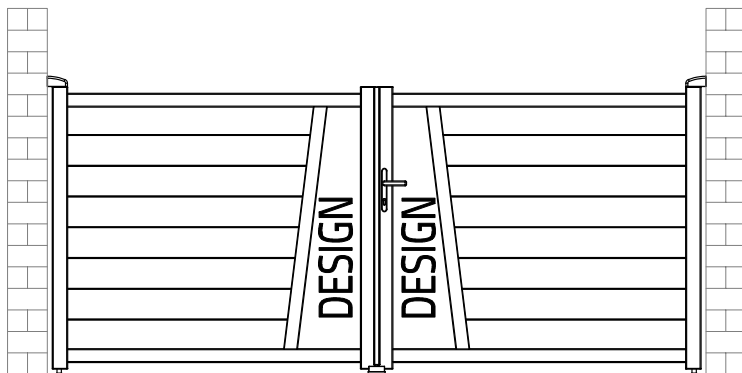



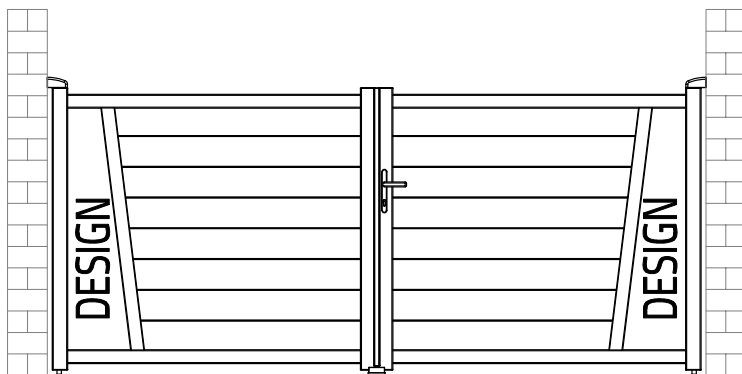

C P: 75~107

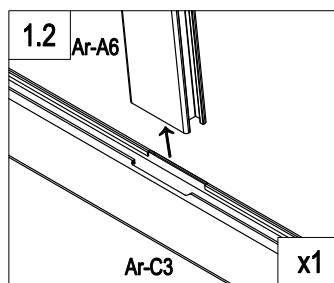
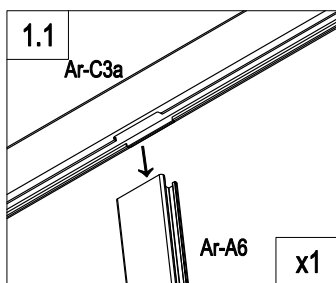
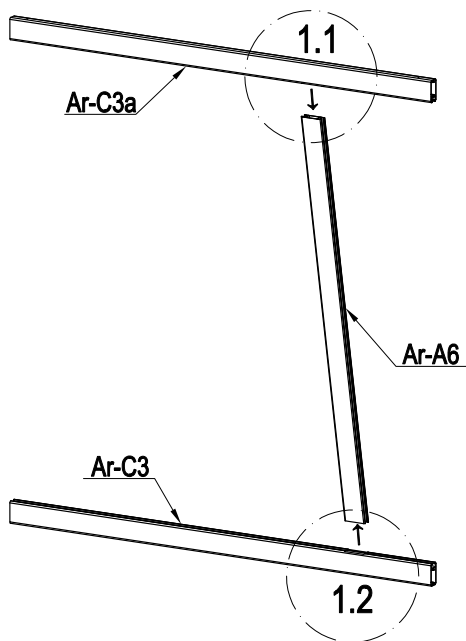

D P: 108~140

A



	Ar-A6	1
	Ar-C3	1
	Ar-C3a	1

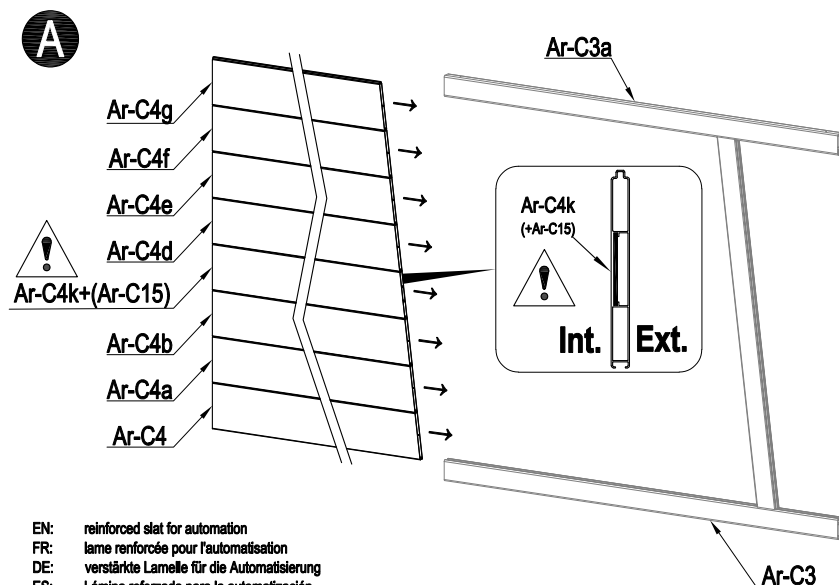

- EN: reinforced slat for automation
 FR: lame renforcée pour l'automatisation
 DE: verstärkte Lamelle für die Automatisierung
 ES: Lámina reforzada para la automatización
 PT: ripa reforçada para automatização
 IT: lamella rinforzata per l'automazione
 NL: versterkte lat voor automatisering
 PL: wzmocniona listwa do automatyzacji

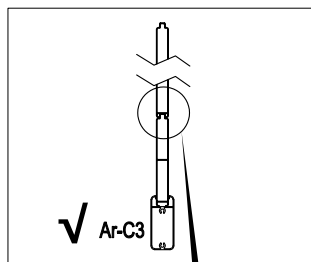
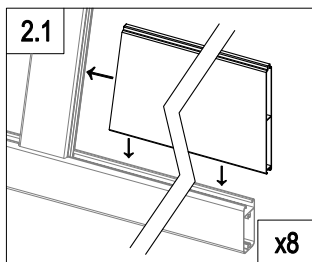



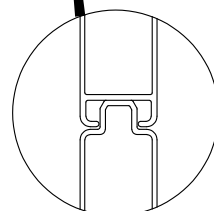

	Ar-C4	1
	Ar-C4a	1
	Ar-C4b	1
	Ar-C4d	1
	Ar-C4e	1

	Ar-C4e	1
	Ar-C4f	1
	Ar-C4g	1
Int. 	Ar-C4k (+Ar-C15)	1
Ext. 		

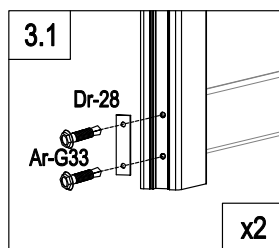
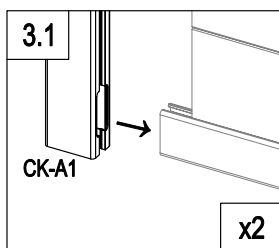
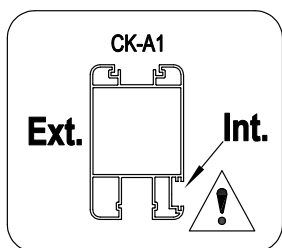
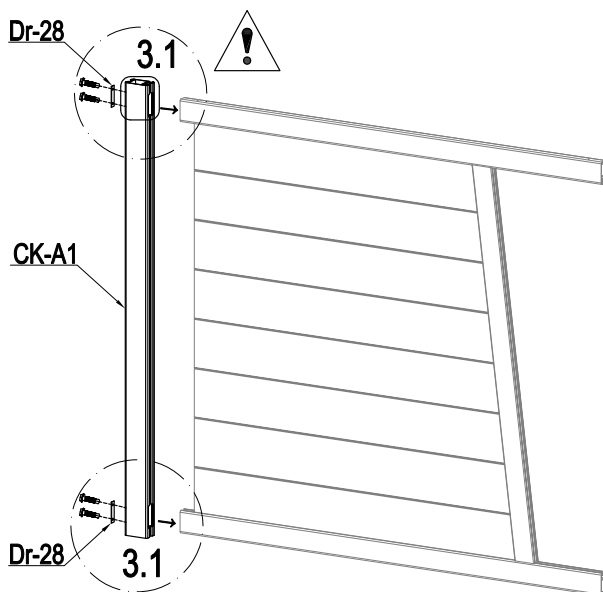



A



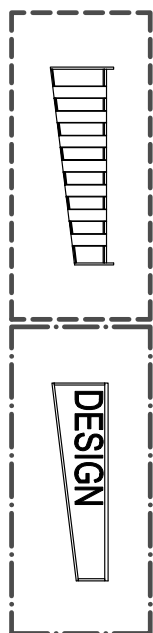
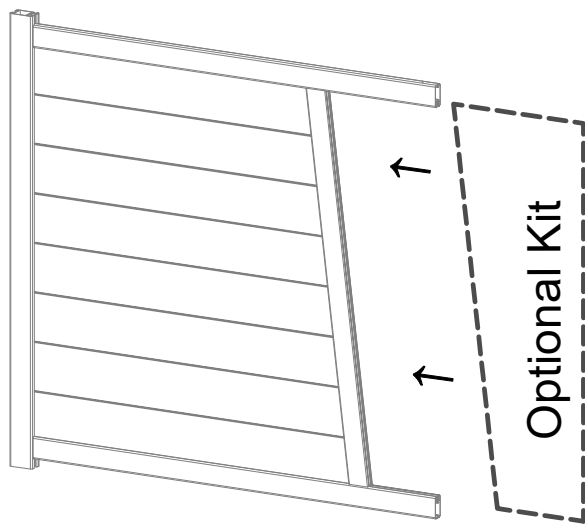

	CK-A1	1
	Dr-28	2
	Ar-G33	4

A



  P:13~17

  P: 18~20

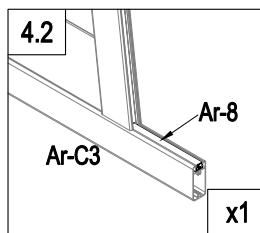
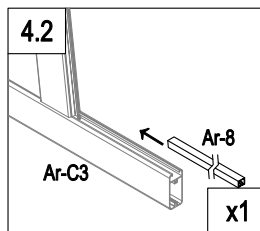
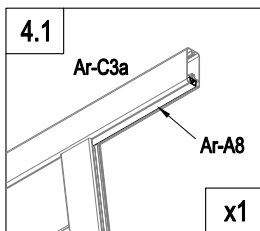
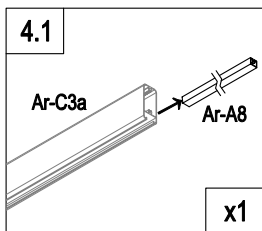
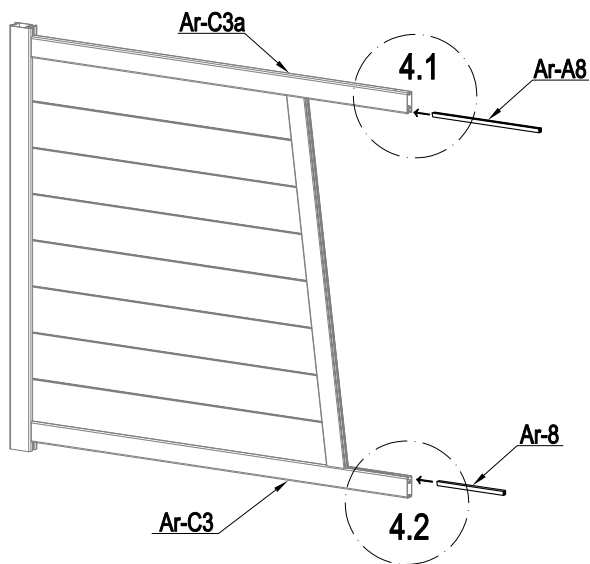

A

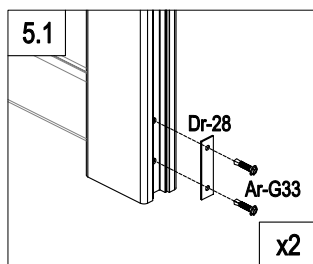
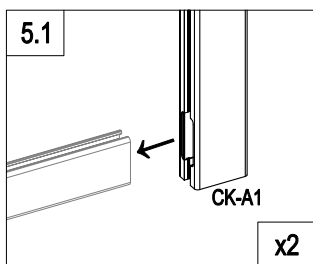
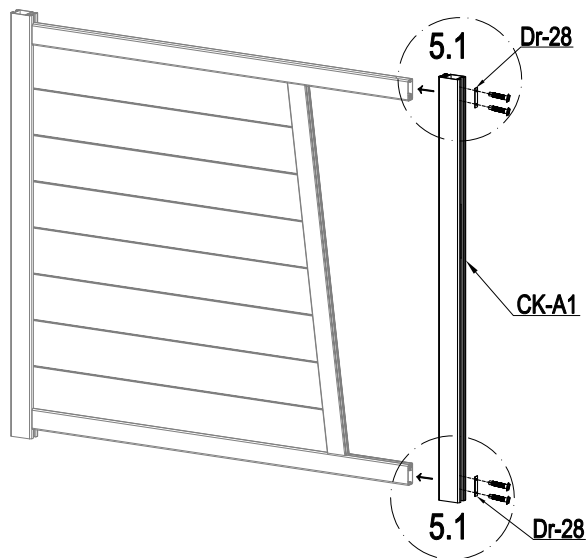

	Ar-8	1
	Ar-A8	1

A



	CK-A1	1
	Dr-28	2
	Ar-G33	4

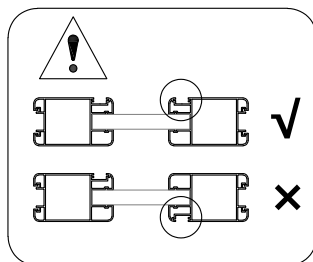

A

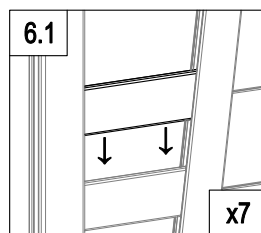
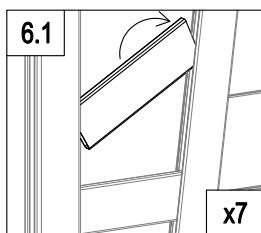
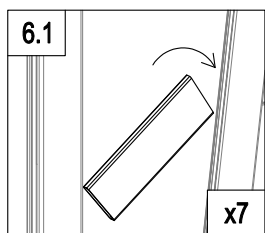
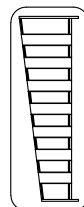
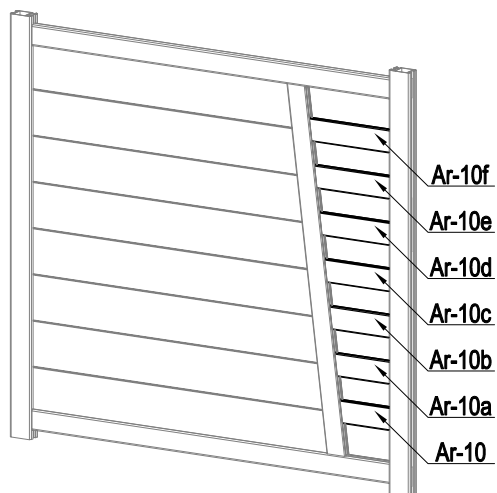

—	Ar-10	1
	Ar-10a	1
	Ar-10b	1
	Ar-10c	1

—	Ar-10d	1
	Ar-10e	1
	Ar-10f	1

A

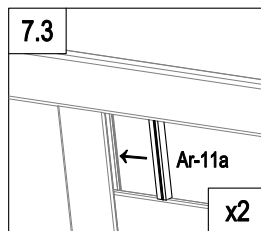
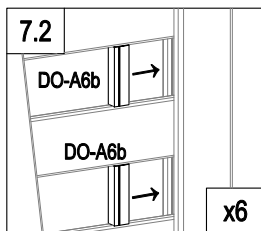
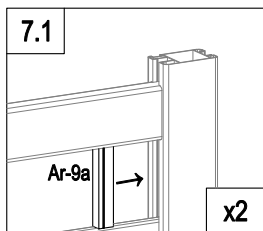
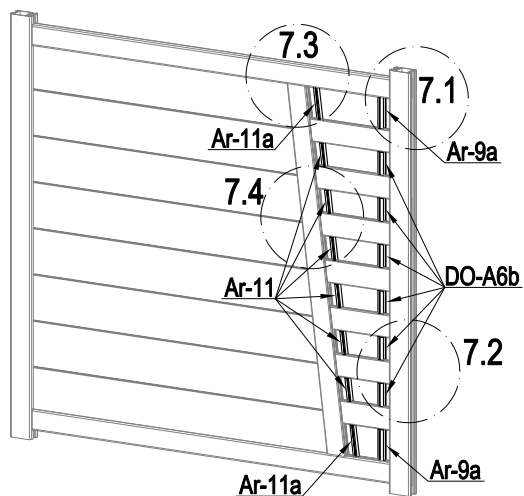

	DO-A6b	6
	Ar-9a	2
	Ar-11	6
	Ar-11a	2

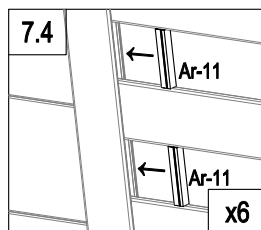

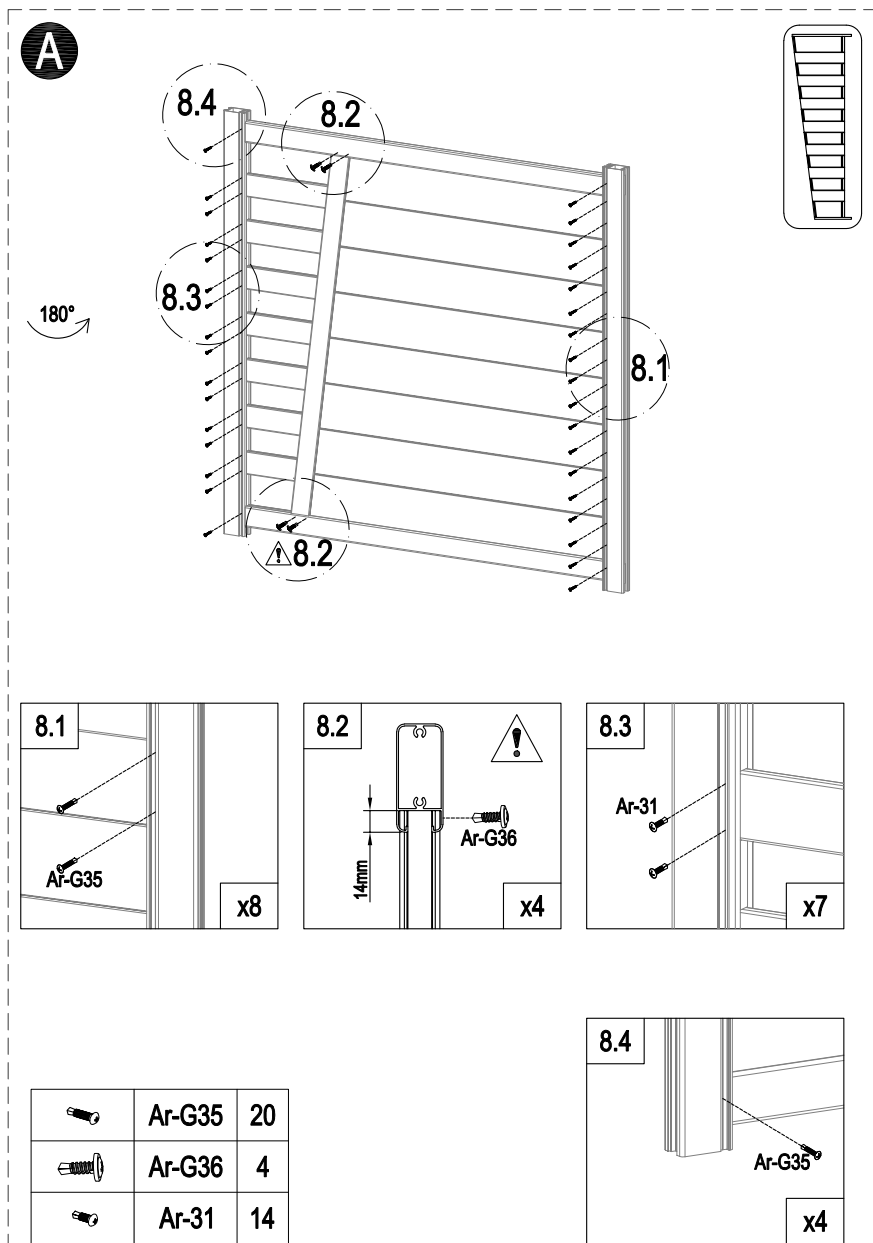

A

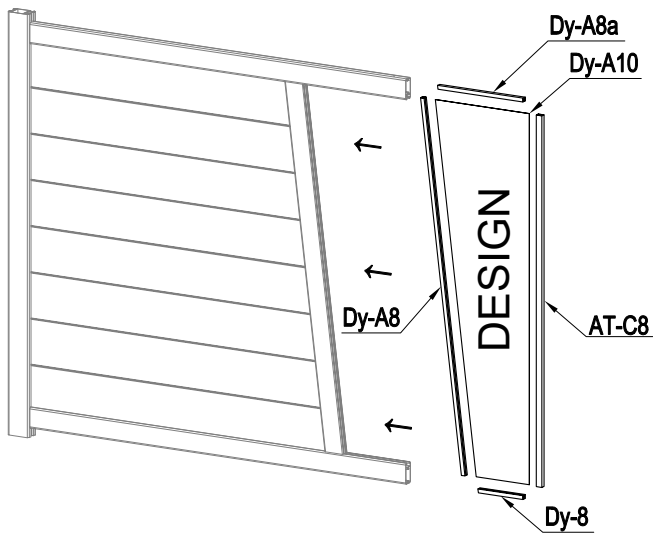

DESIGN

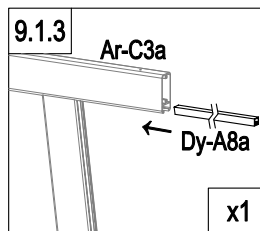
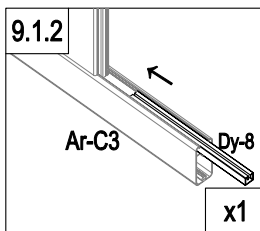
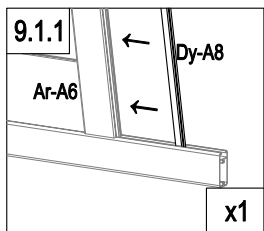

□	Dy-A8	1
	Dy-A8a	1
	Dy-8	1
▢	AT-C8	1
DESIGN	Dy-A10	1

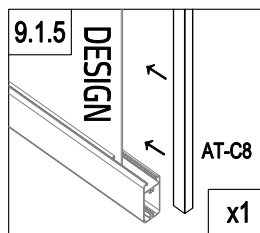
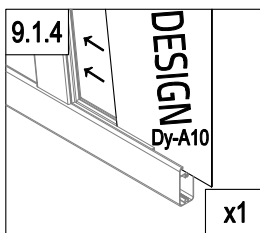

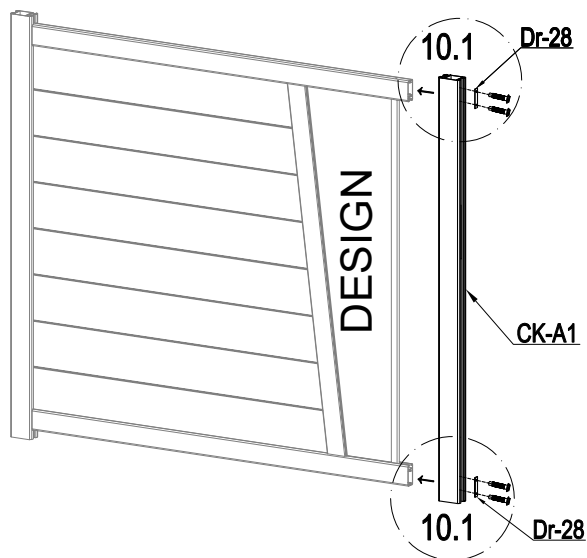

A

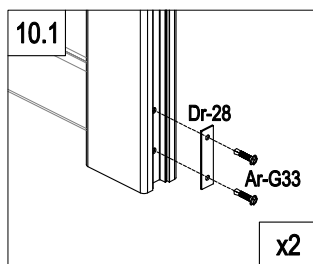
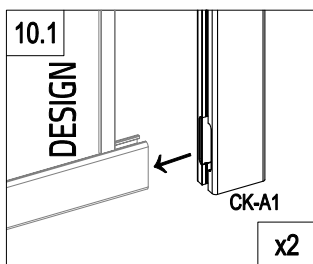

DESIGN



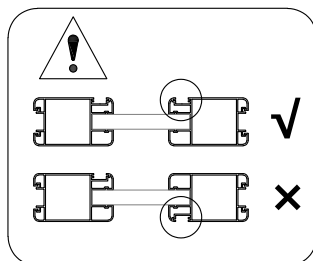

	CK-A1	1
	Dr-28	2
	Ar-G33	4

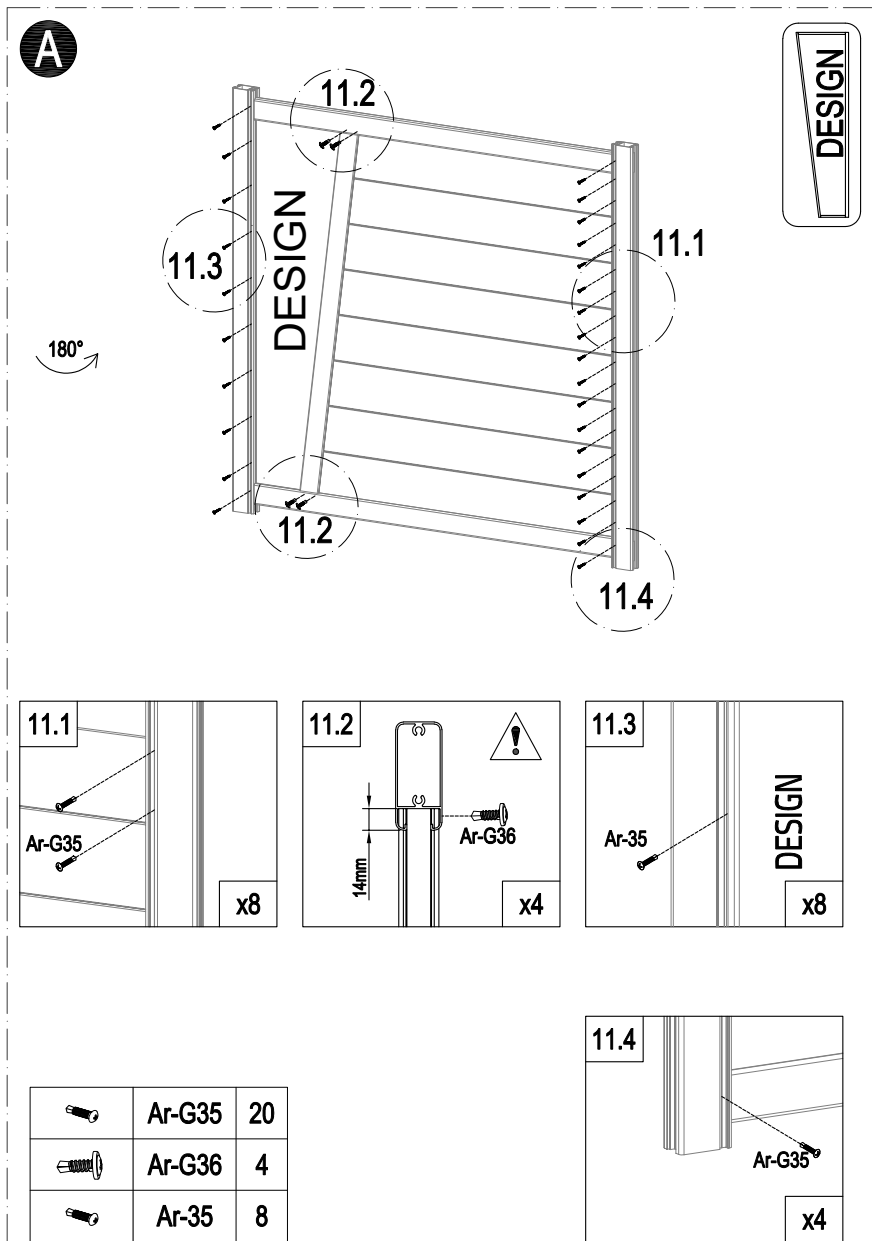

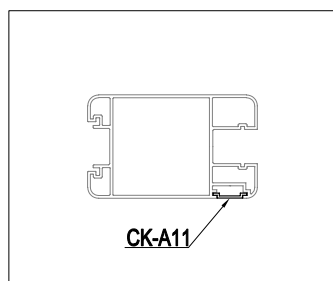
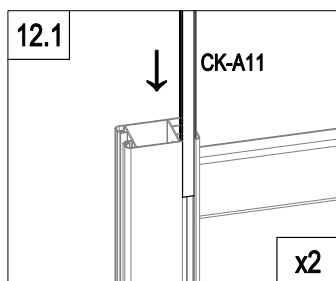
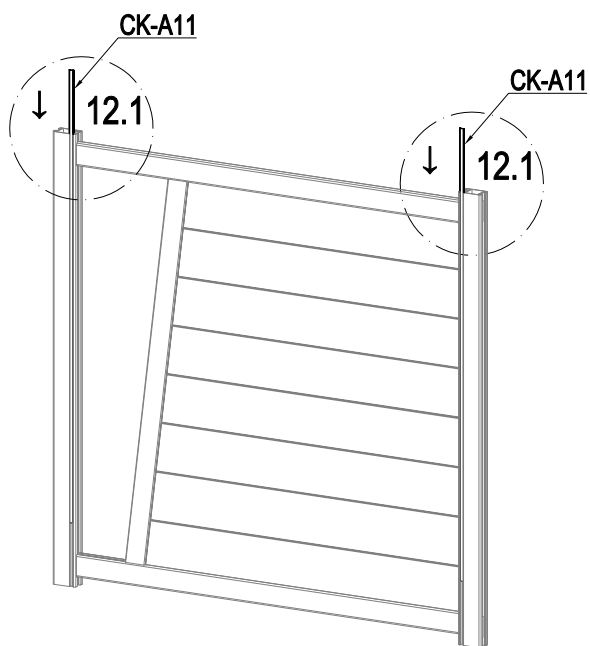

A



	CK-A11	2
---	--------	---

A

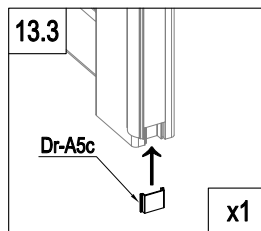
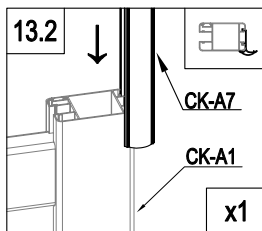
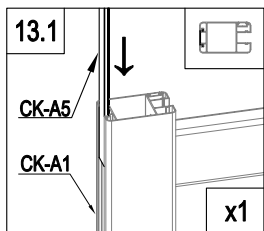
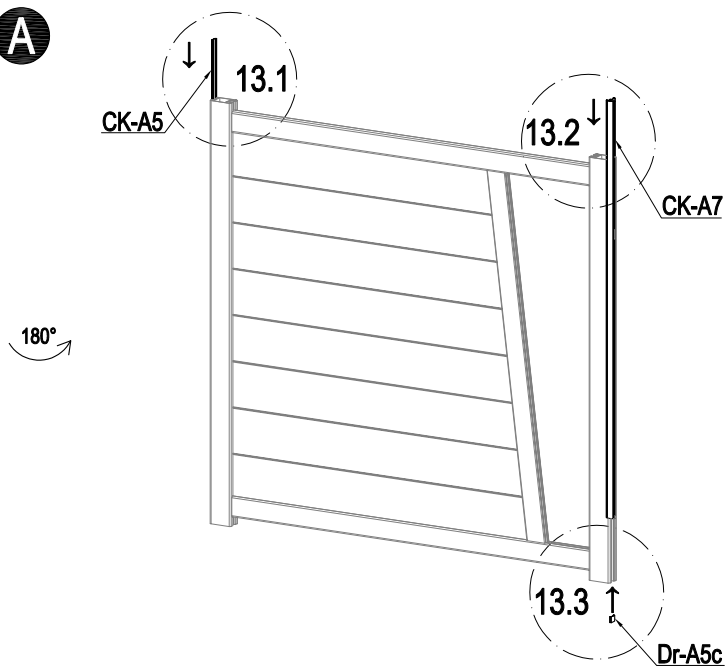



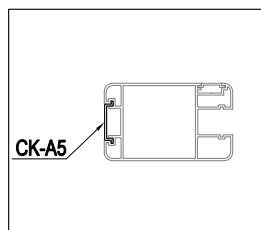

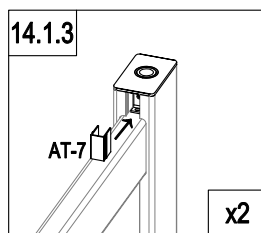
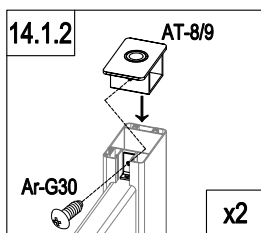
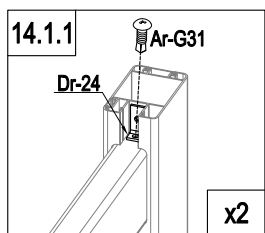
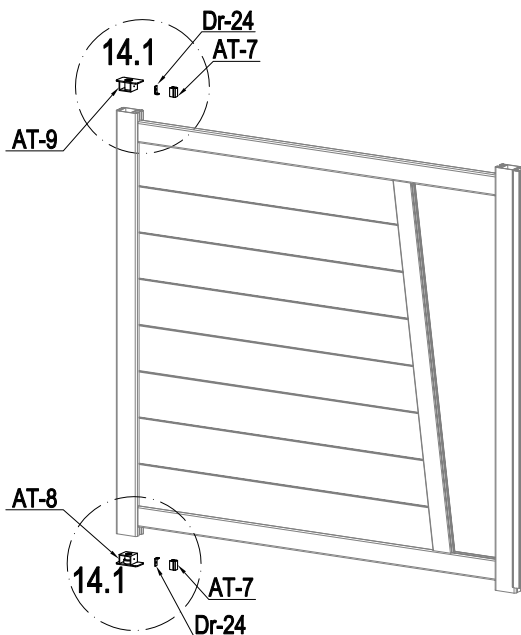

	CK-A5	1
	Dr-A5c	1
	CK-A7	1



A



	AT-8	1
	AT-9	1
	Dr-24	2

	AT-7	2
	Ar-G30	2
	Ar-G31	2

A

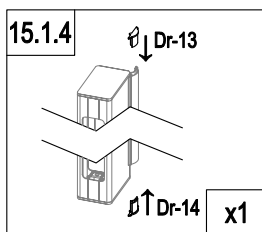
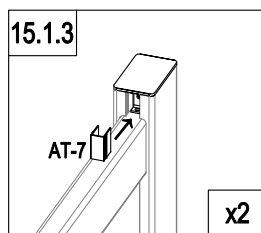
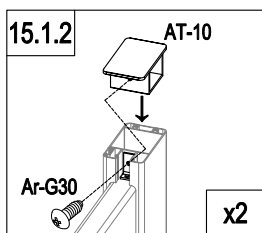
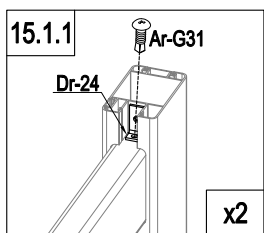
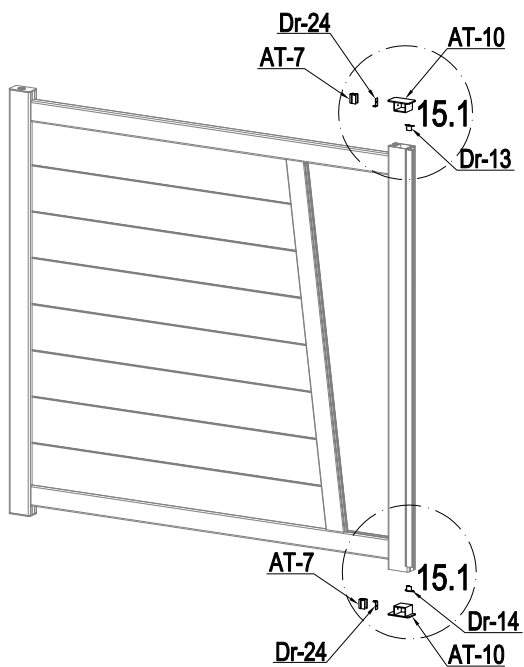



	AT-10	2
	Dr-24	2
	AT-7	2
	Dr-13	1

	Dr-14	1
	Ar-G30	2
	Ar-G31	2

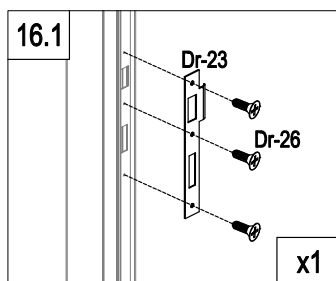
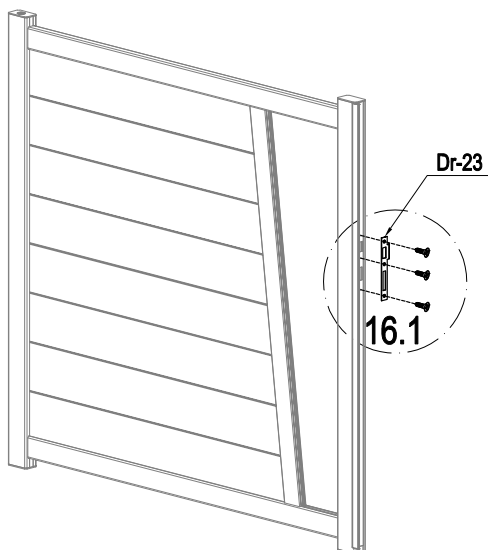

A

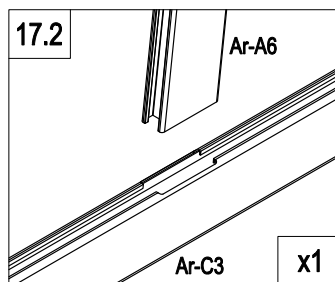
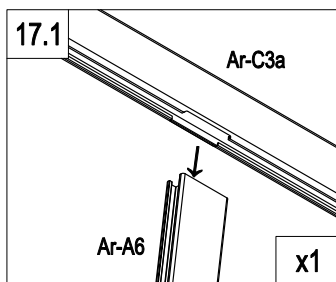
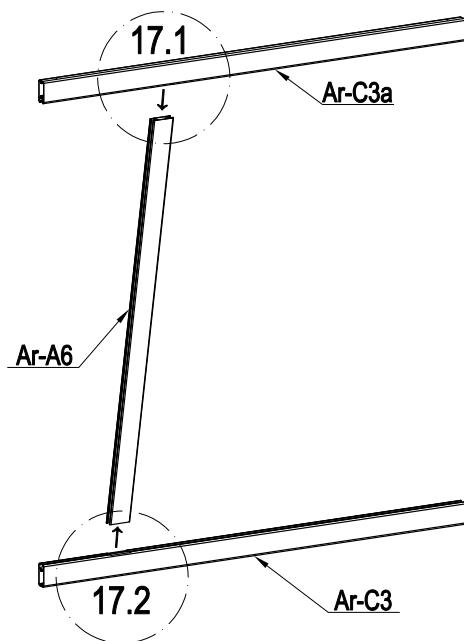

	Dr-23	1
	Dr-26	3

A





	Ar-A6	1
	Ar-C3	1
	Ar-C3a	1

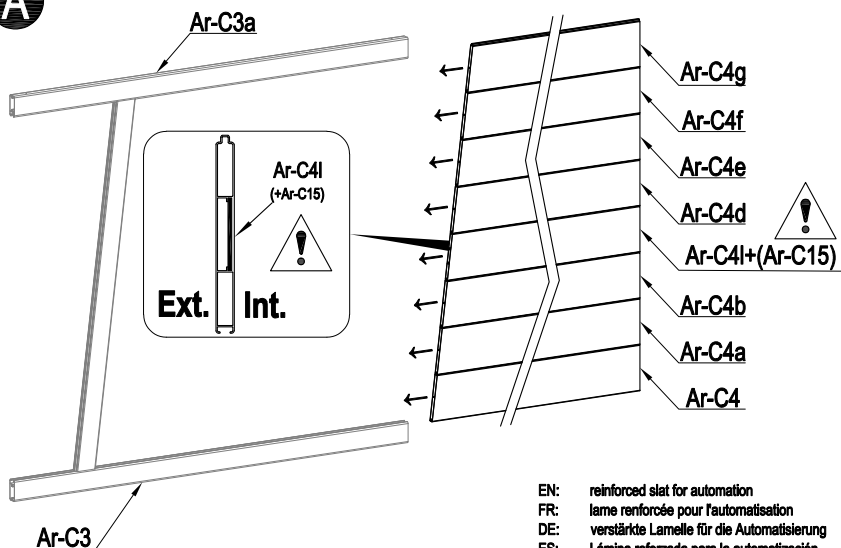

A

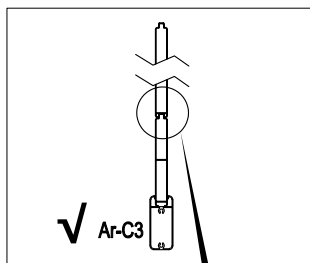
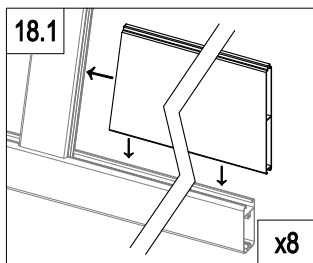

- EN: reinforced slat for automation
- FR: lame renforcée pour l'automatisation
- DE: verstärkte Lamelle für die Automatisierung
- ES: Lámina reforzada para la automatización
- PT: ripa reforçada para automatização
- IT: lamella rinforzata per l'automazione
- NL: versterkte lat voor automatisering
- PL: wzmocniona listwa do automatyzacji





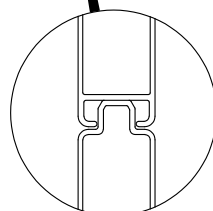

	Ar-C4	1
	Ar-C4a	1
	Ar-C4b	1
	Ar-C4d	1
	Ar-C4e	1

	Ar-C4e	1
	Ar-C4f	1
	Ar-C4g	1
Int. 	Ar-C4I (+Ar-C15)	1
Ext.		

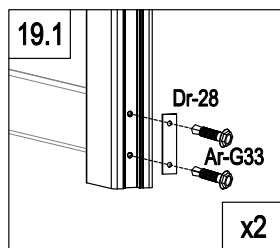
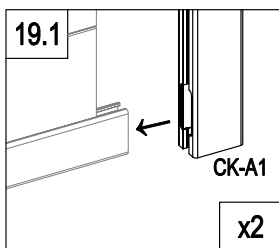
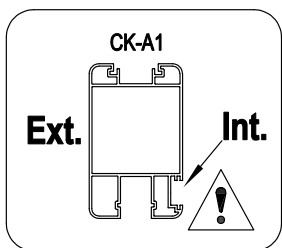
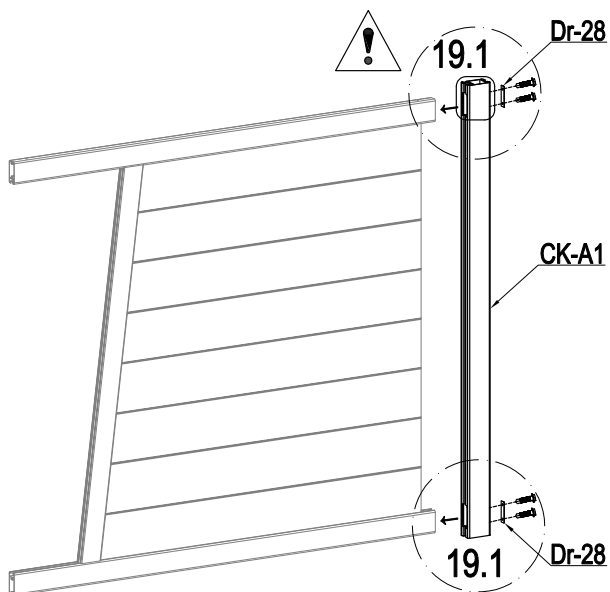



A



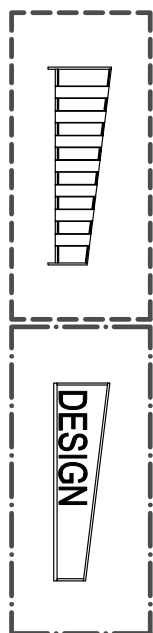
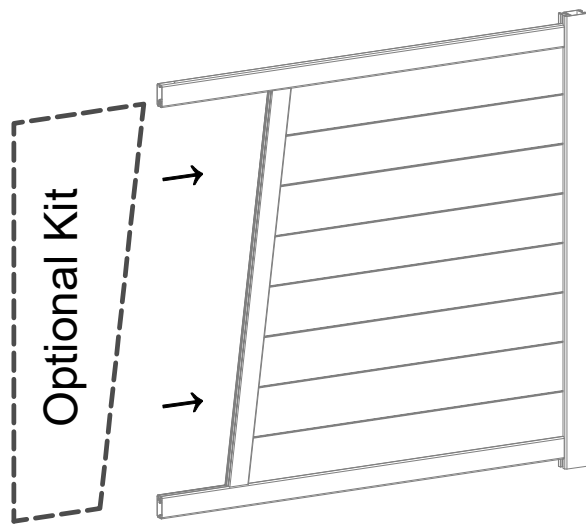

	CK-A1	1
	Dr-28	2
	Ar-G33	4

A



  P:30~34

  P:35~37

A

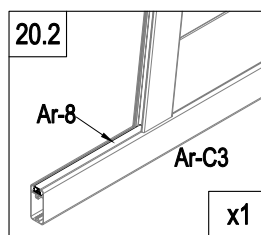
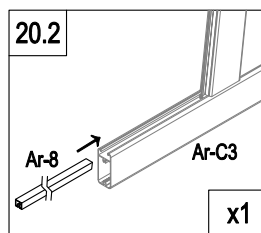
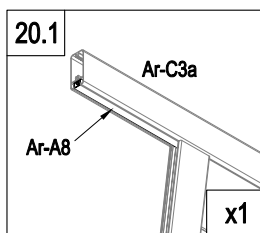
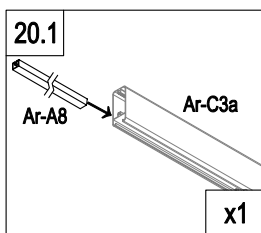
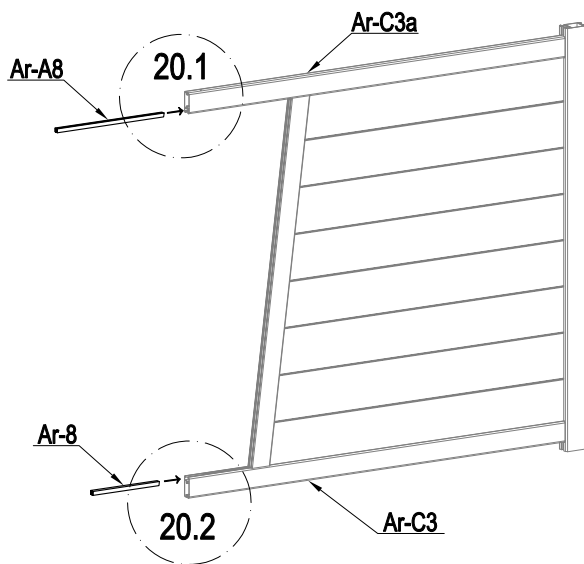

	Ar-8	1
	Ar-A8	1

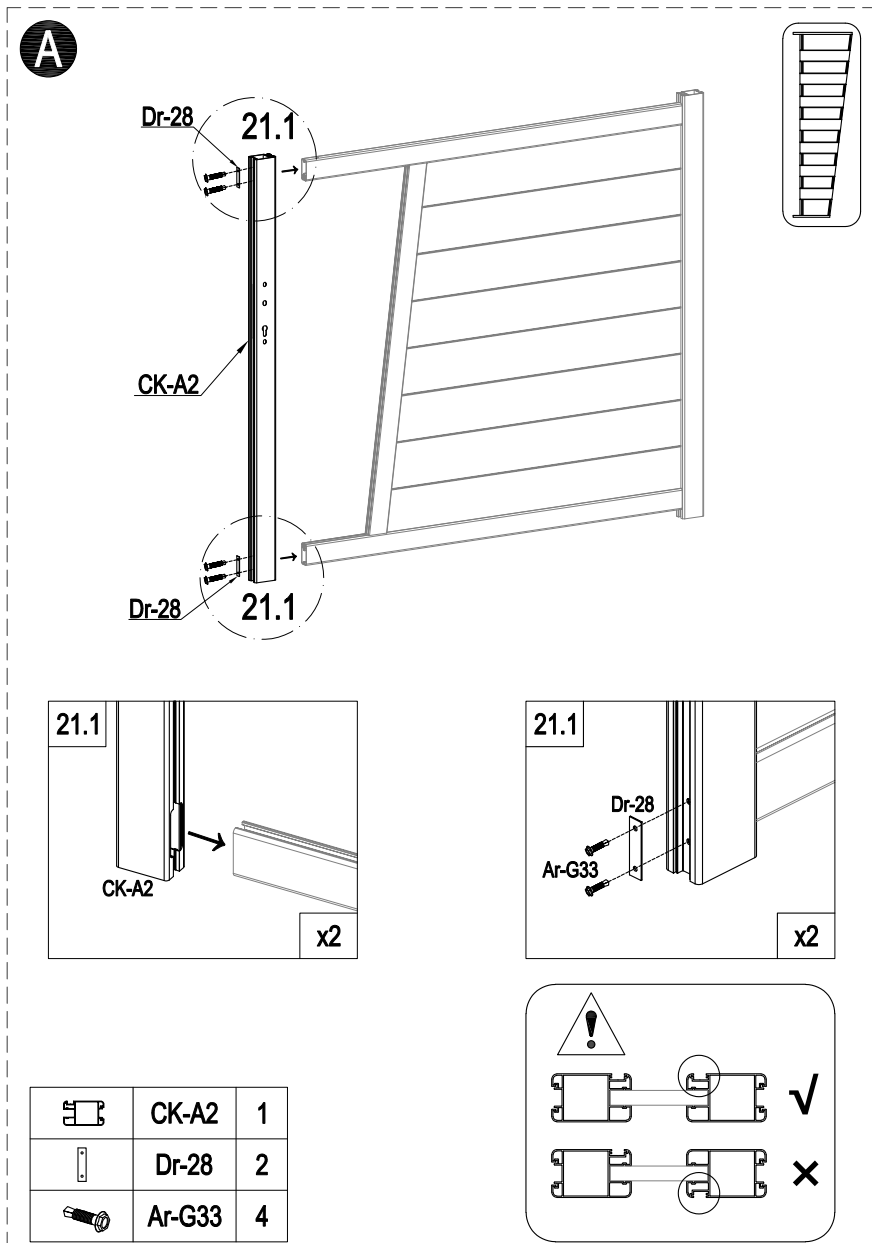

A

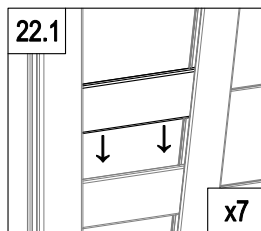
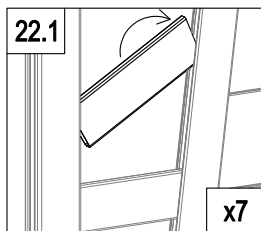
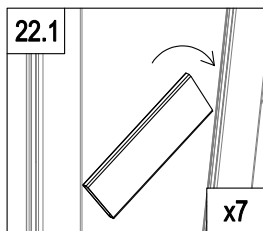
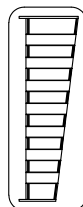
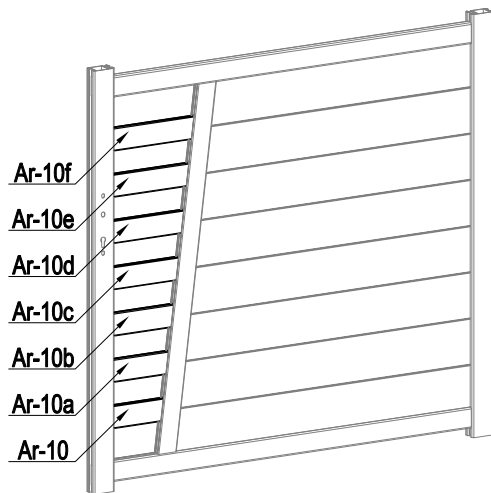



—	Ar-10	1
	Ar-10a	1
	Ar-10b	1
	Ar-10c	1

—	Ar-10d	1
	Ar-10e	1
	Ar-10f	1

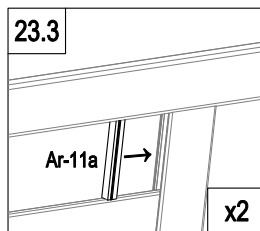
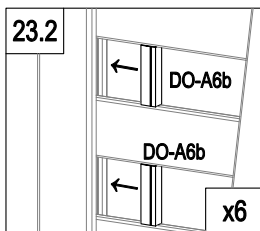
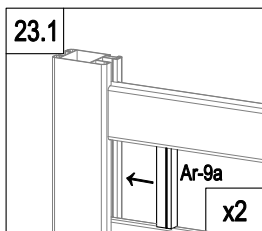
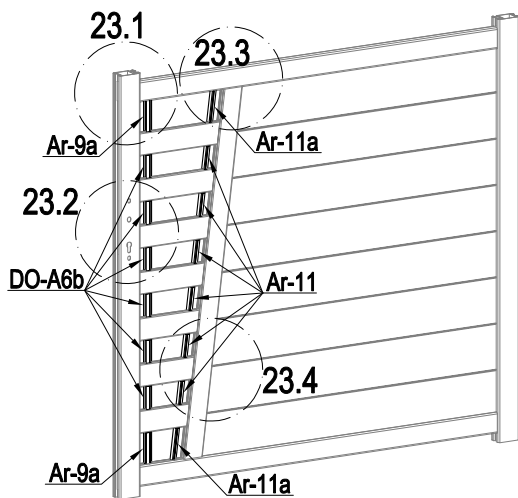
A



	DO-A6b	6
	Ar-9a	2
	Ar-11	6
	Ar-11a	2

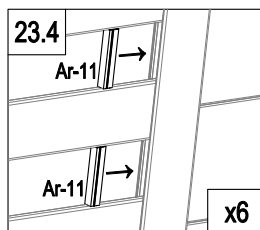

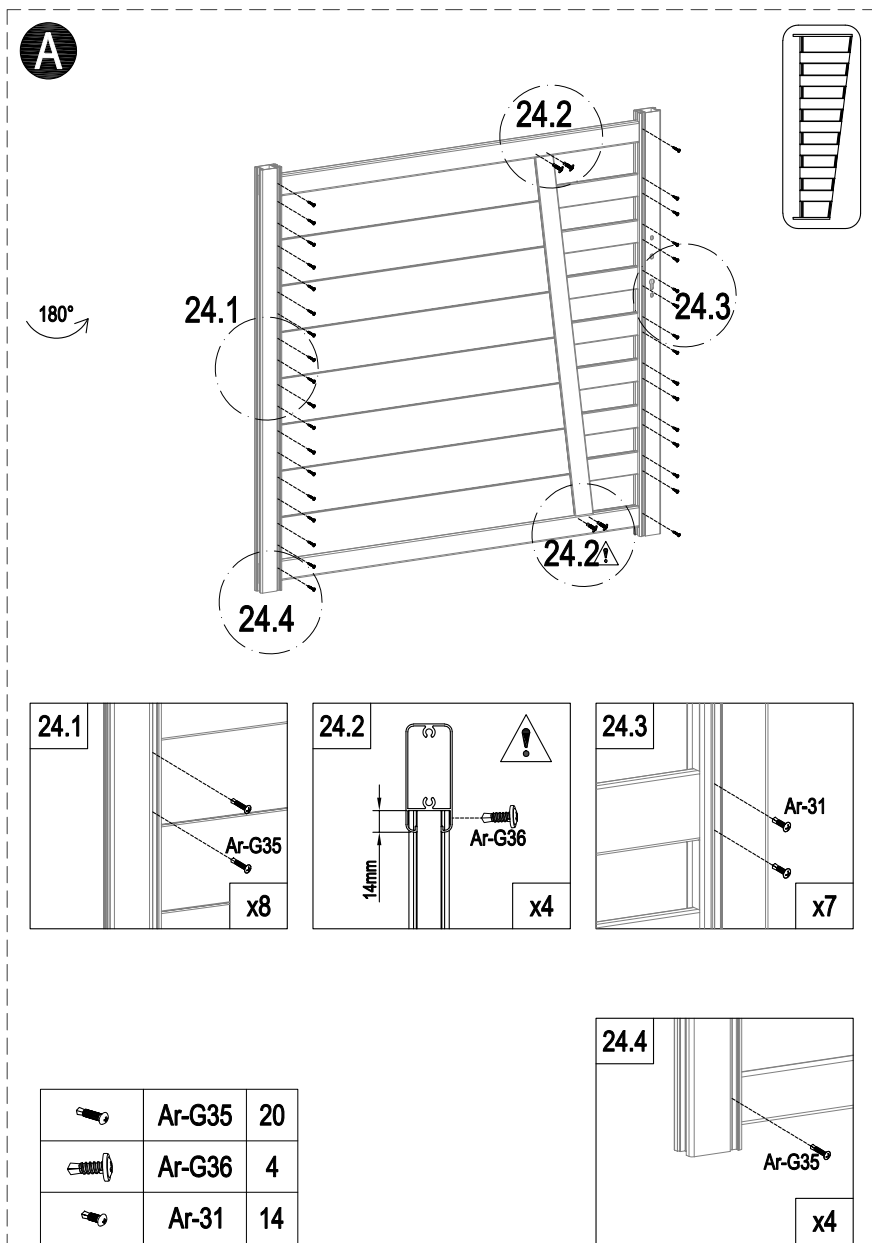

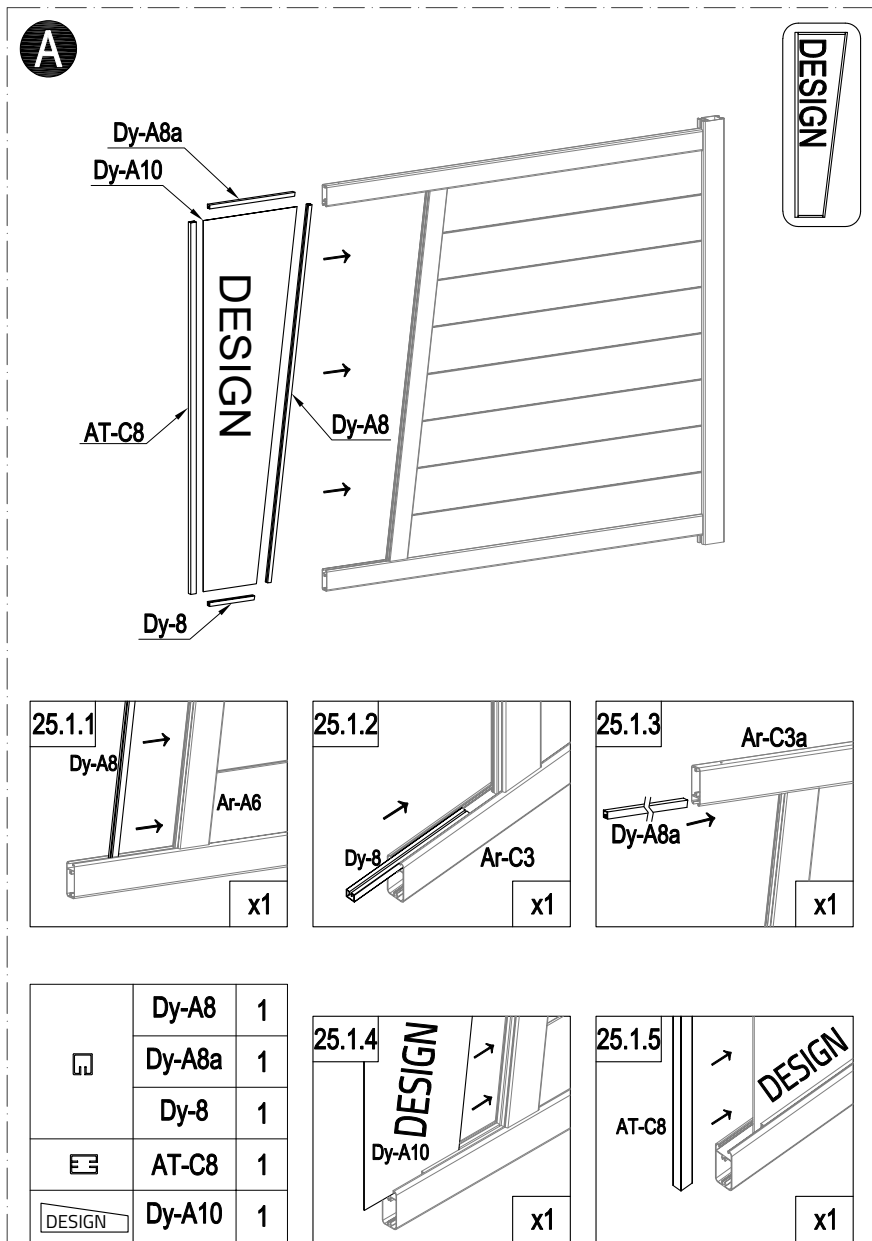



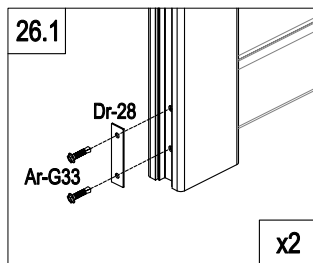
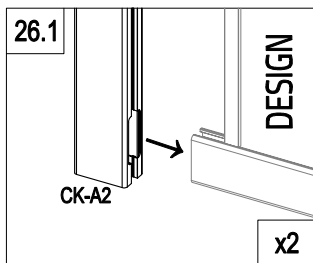
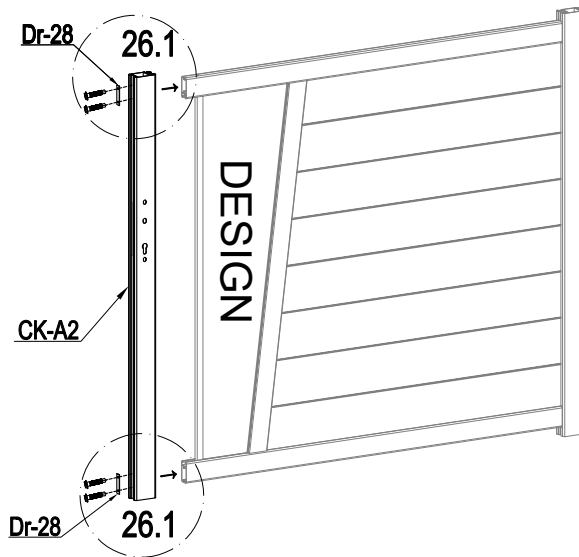

A

DESIGN



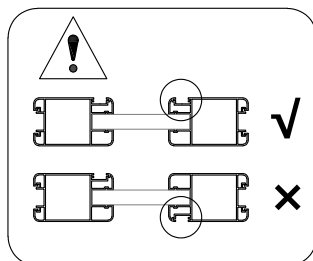

	CK-A2	1
	Dr-28	2
	Ar-G33	4

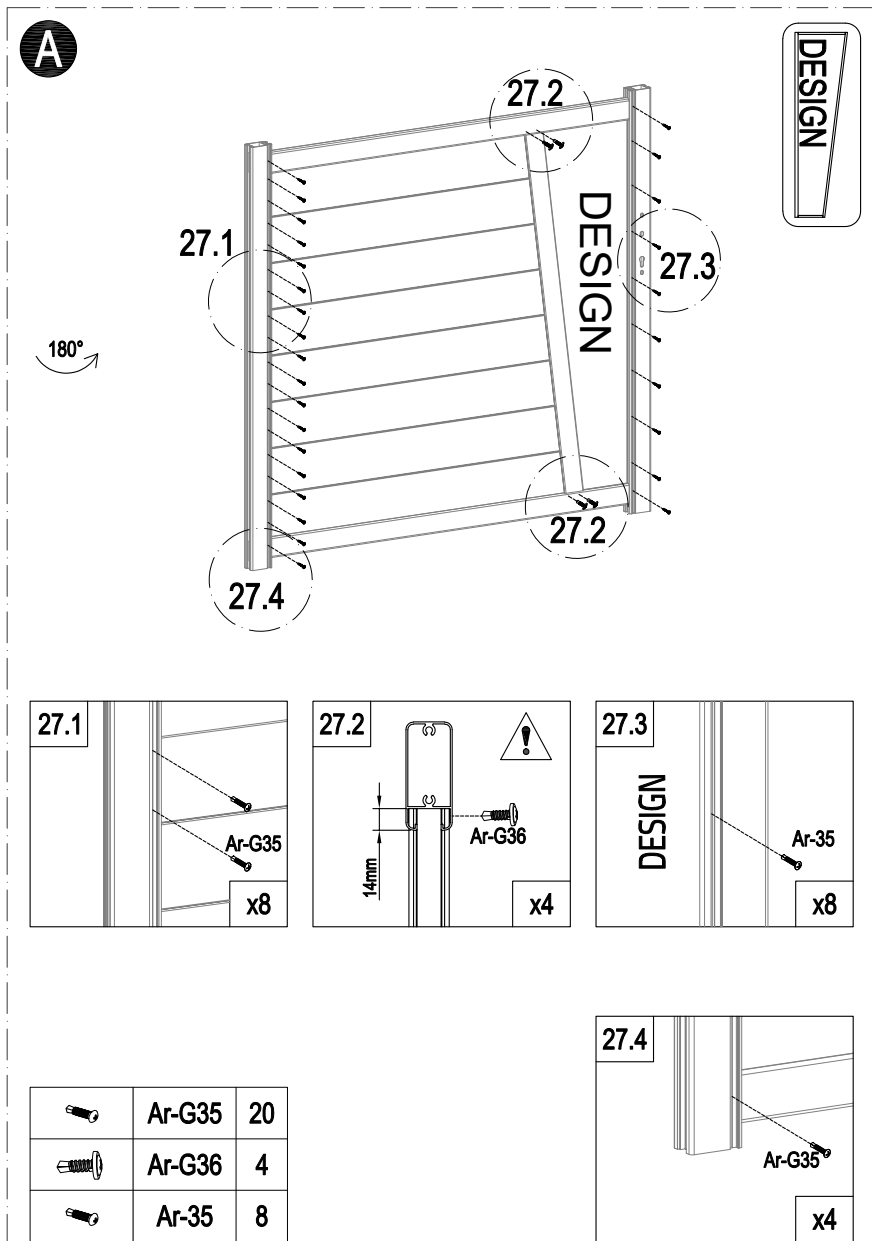



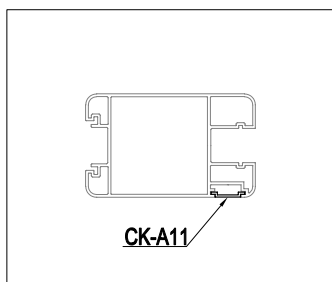
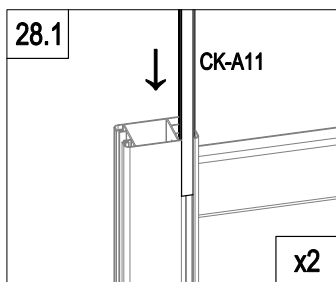
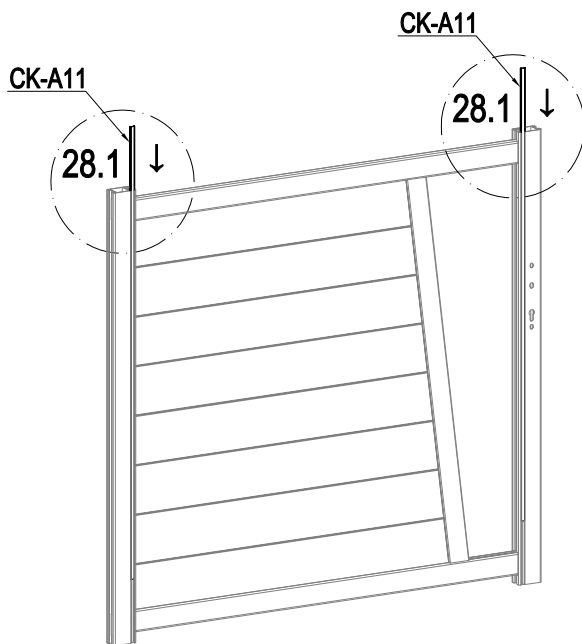

A

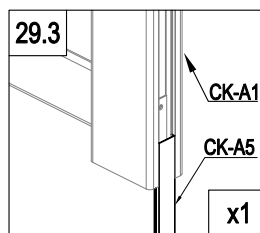
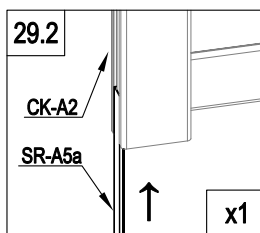
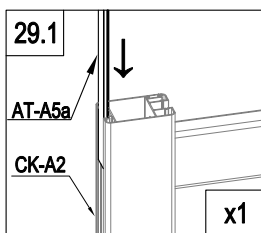
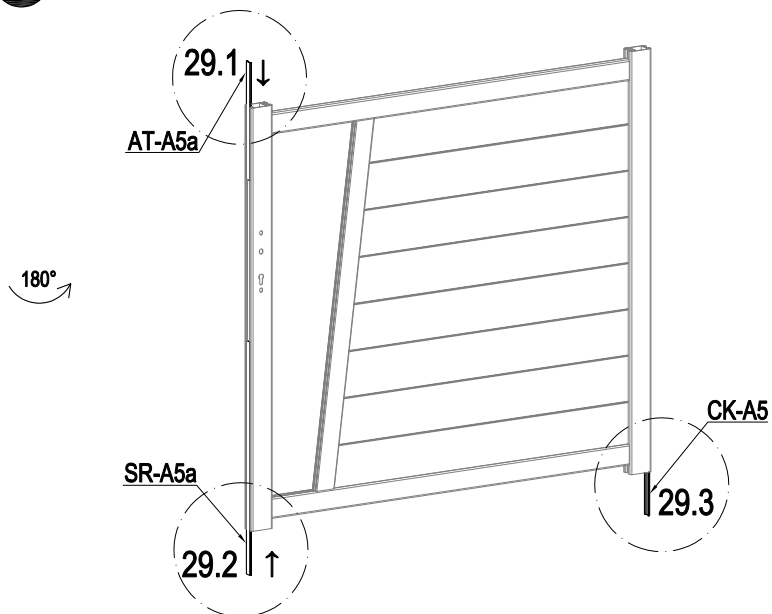

	CK-A11	2
---	---------------	----------

A



	CK-A5	1
	AT-A5a	1
	SR-A5a	1

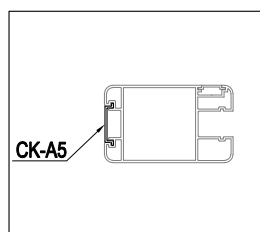

A

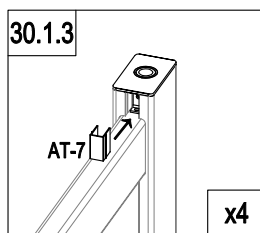
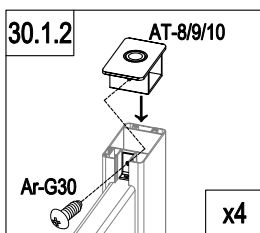
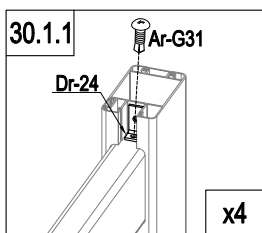
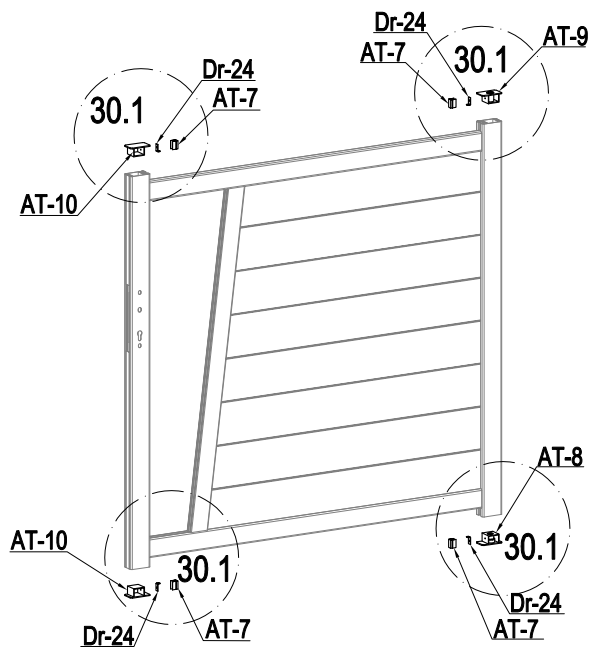

	AT-8	1
	AT-9	1
	AT-10	2
	Dr-24	4

	AT-7	4
	Ar-G30	4
	Ar-G31	4

A

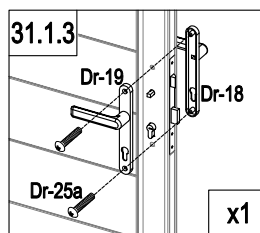
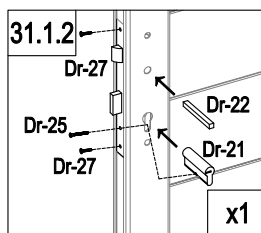
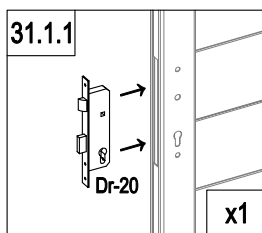
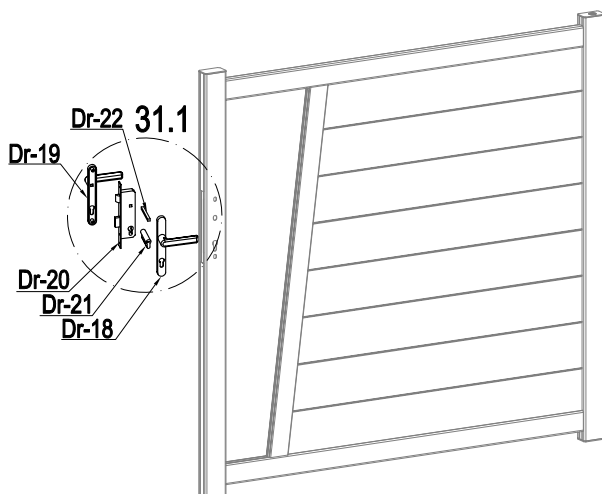



	Dr-20	1
	Dr-21	1
	Dr-22	1
	Dr-25	1

	Dr-18	1
	Dr-19	1
	Dr-25a	2
	Dr-27	2

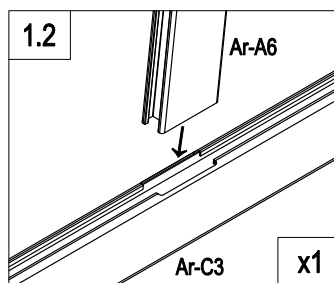
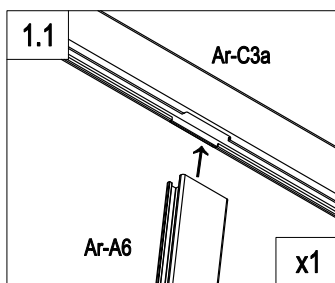
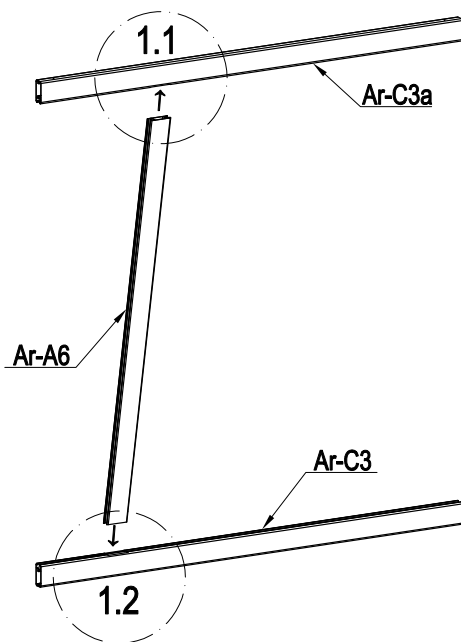
B



	Ar-A6	1
	Ar-C3	1
	Ar-C3a	1

B

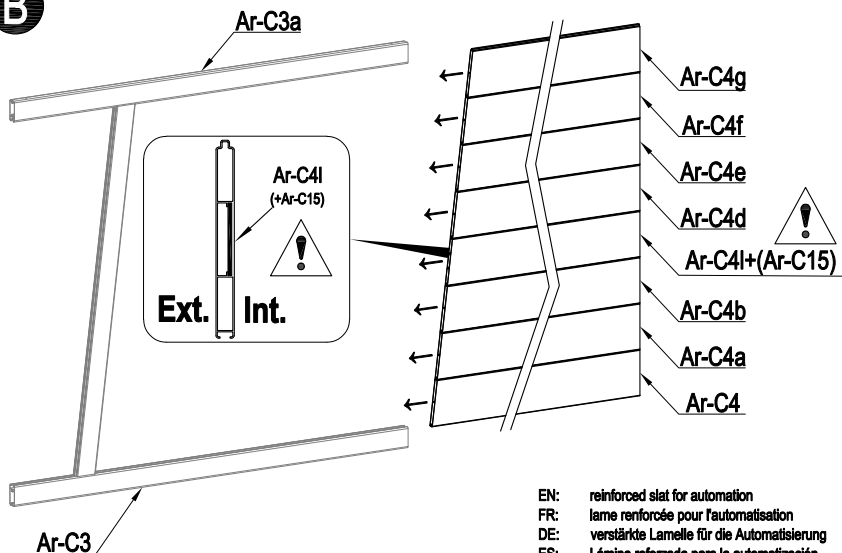

EN: reinforced slat for automation
 FR: lame renforcée pour l'automatisation
 DE: verstärkte Lamelle für die Automatisierung
 ES: Lámina reforzada para la automatización
 PT: ripa reforçada para automatização
 IT: lamella rinforzata per l'automazione
 NL: versterkte lat voor automatisering
 PL: wzmocniona listwa do automatyzacji

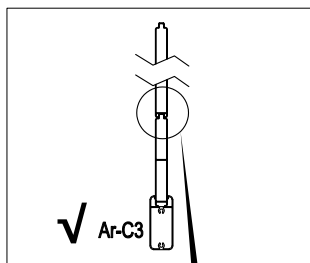
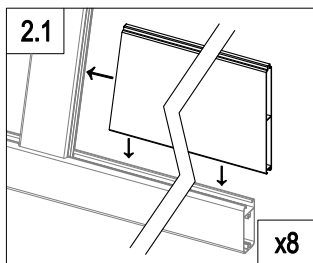



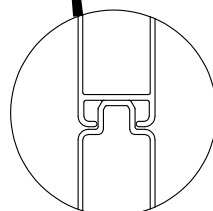

	Ar-C4	1
	Ar-C4a	1
	Ar-C4b	1
	Ar-C4d	1
	Ar-C4e	1

	Ar-C4e	1
	Ar-C4f	1
	Ar-C4g	1
Int. 	Ar-C4l (+Ar-C15)	1
Ext.		

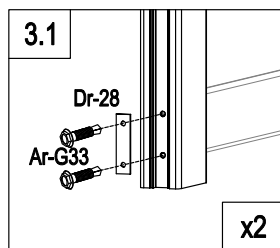
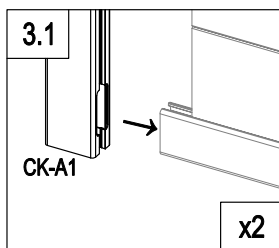
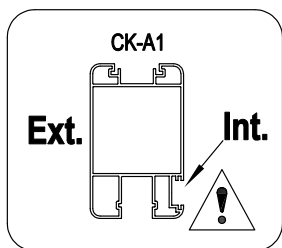
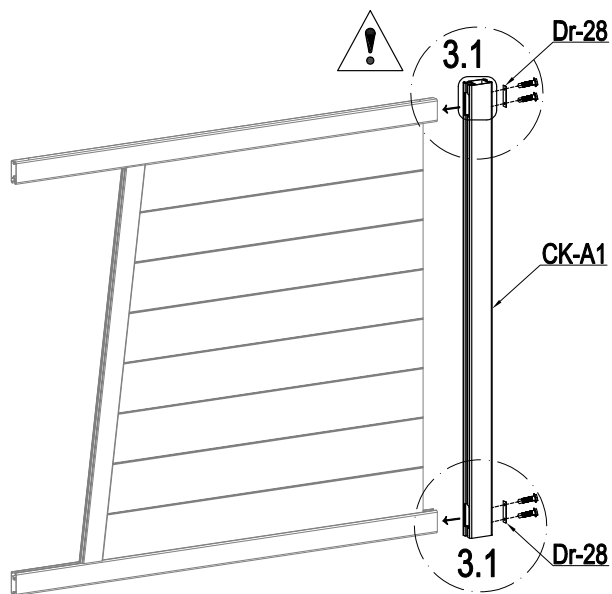



B



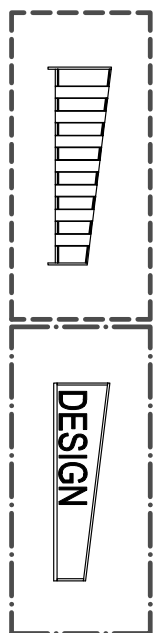
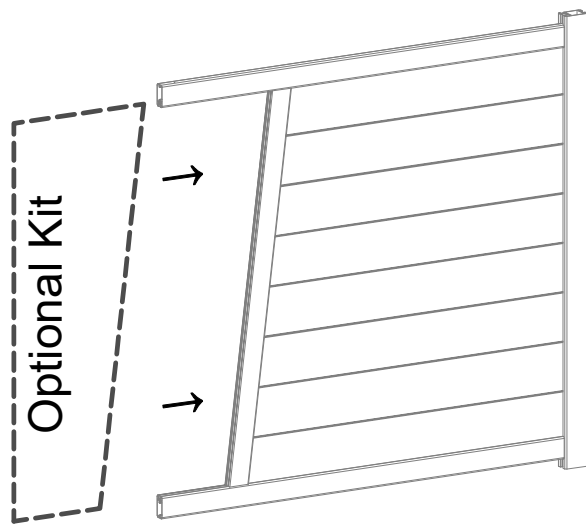

	CK-A1	1
	Dr-28	2
	Ar-G33	4

B



 P:46~50



 P: 51~53

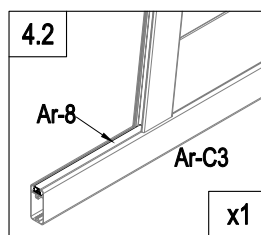
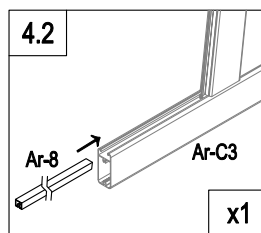
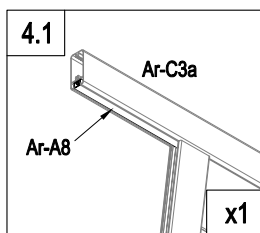
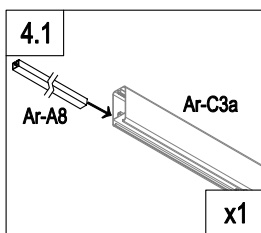
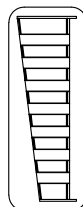
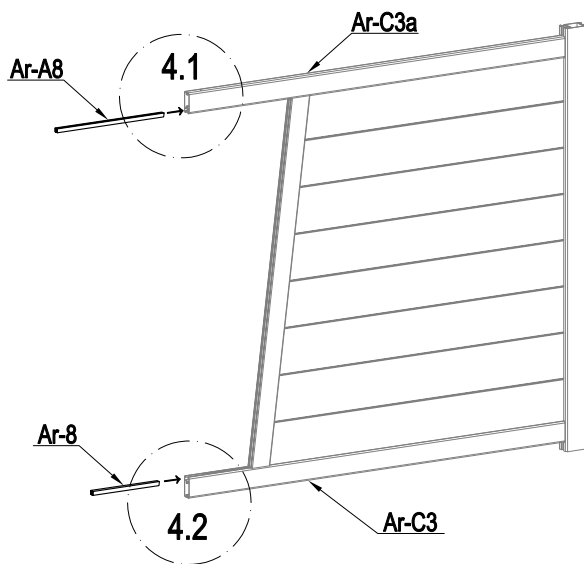

B

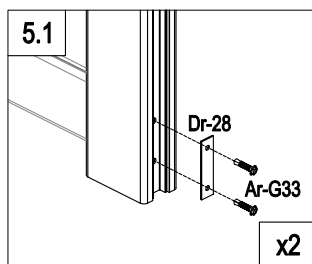
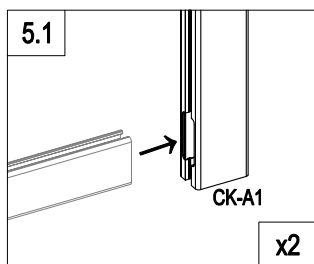
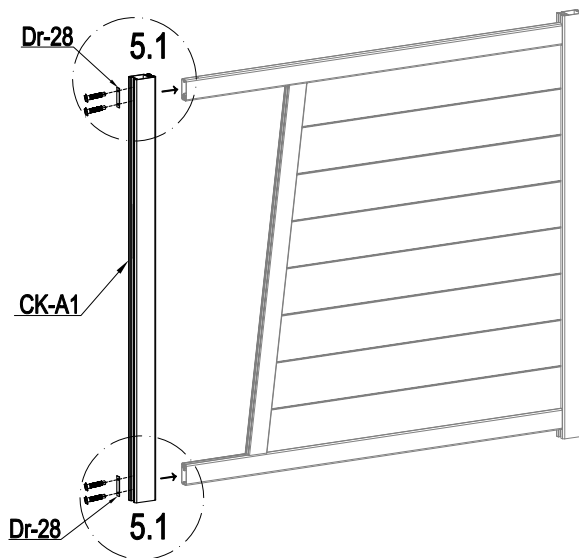

	Ar-8	1
	Ar-A8	1

B



	CK-A1	1
	Dr-28	2
	Ar-G33	4

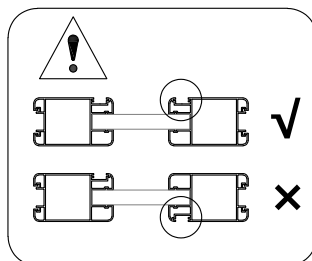

B

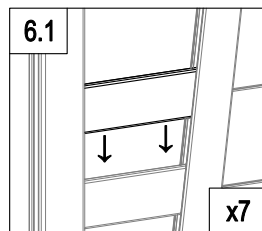
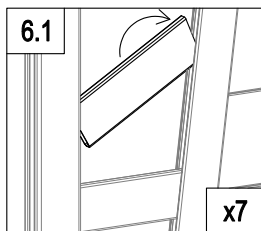
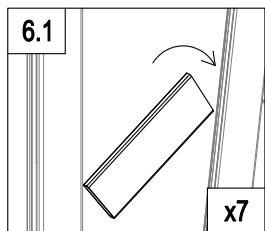
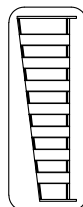
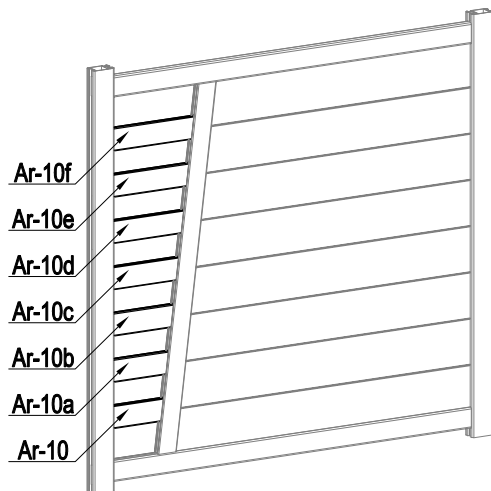



—	Ar-10	1
	Ar-10a	1
	Ar-10b	1
	Ar-10c	1

—	Ar-10d	1
	Ar-10e	1
	Ar-10f	1

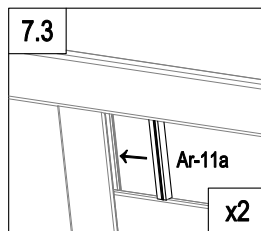
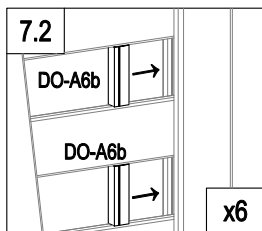
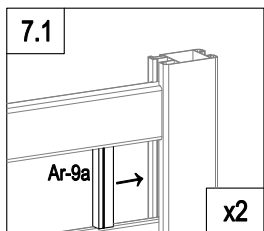
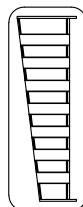
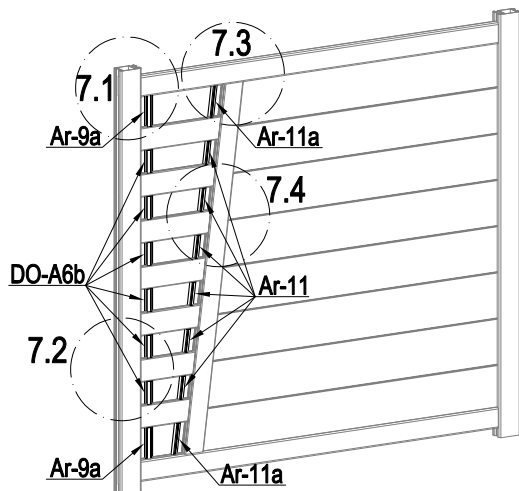
B



	DO-A6b	6
	Ar-9a	2
	Ar-11	6
	Ar-11a	2

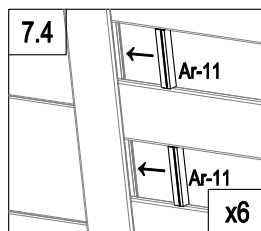

B

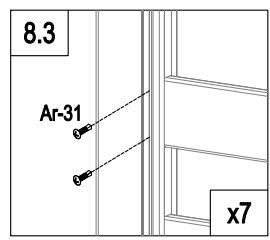
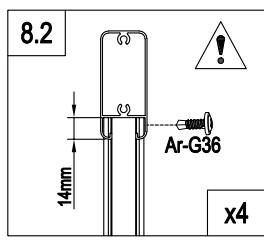
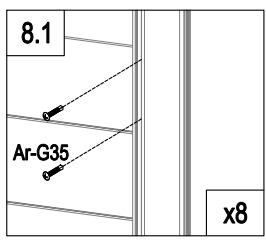
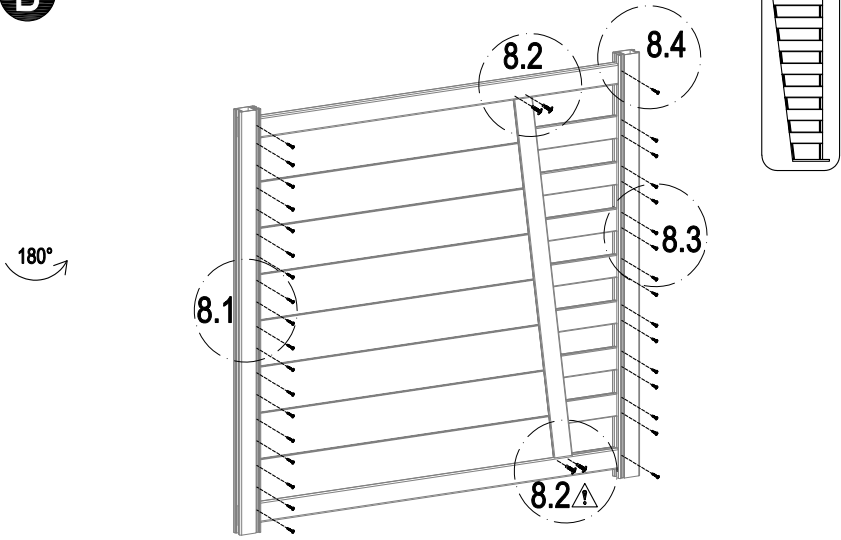

	Ar-G35	20
	Ar-G36	4
	Ar-31	14

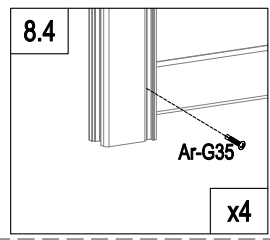

B

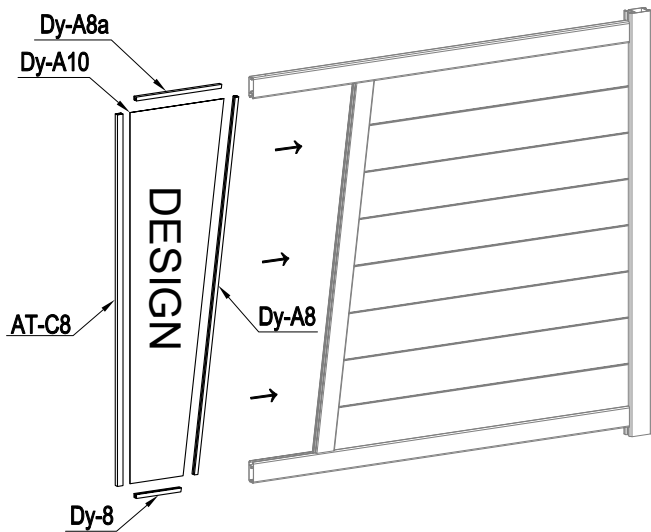

DESIGN

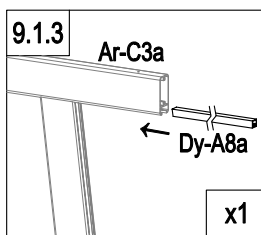
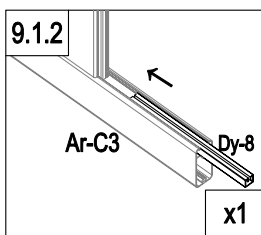
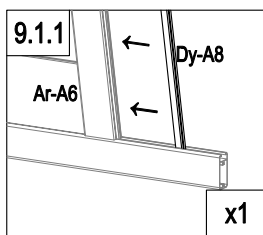



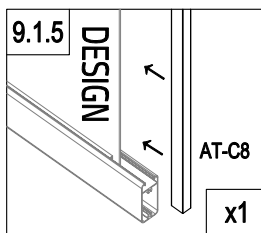
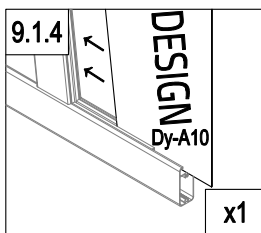

□	Dy-A8	1
	Dy-A8a	1
	Dy-8	1
▢	AT-C8	1
DESIGN	Dy-A10	1

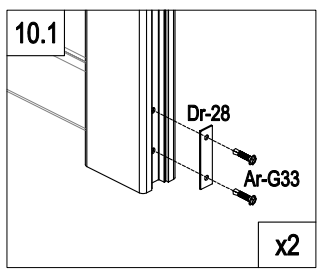
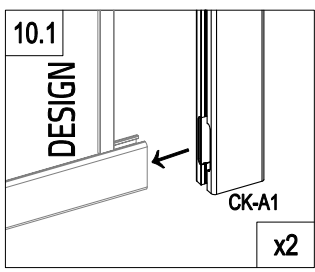
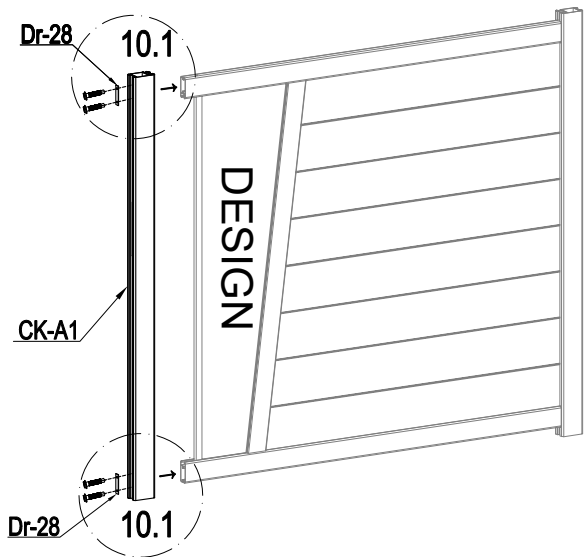

B

DESIGN



	CK-A1	1
	Dr-28	2
	Ar-G33	4

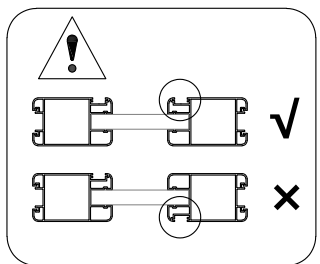

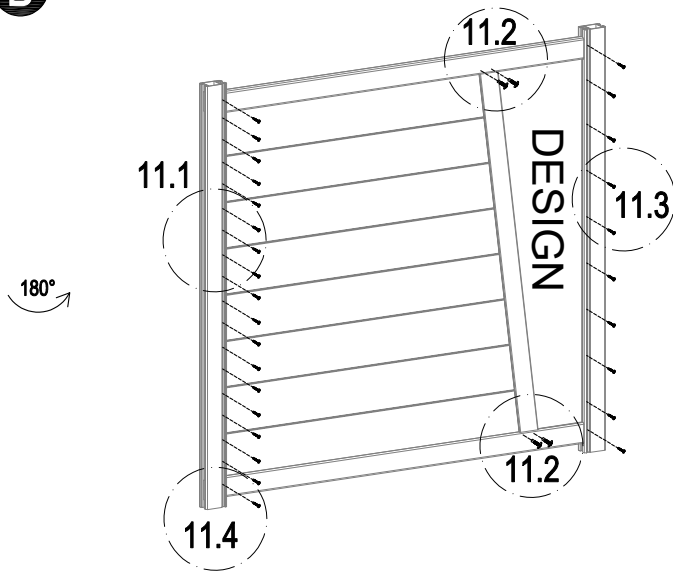

B

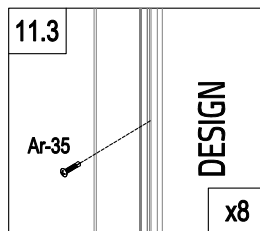
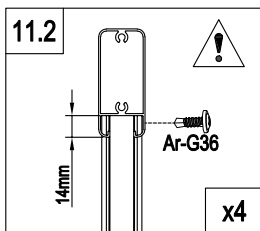
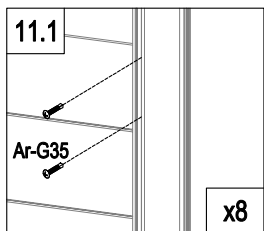

DESIGN



	Ar-G35	20
	Ar-G36	4
	Ar-35	8

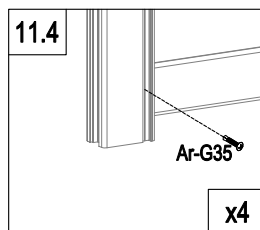

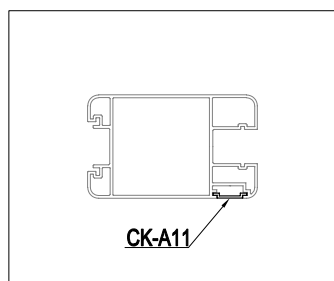
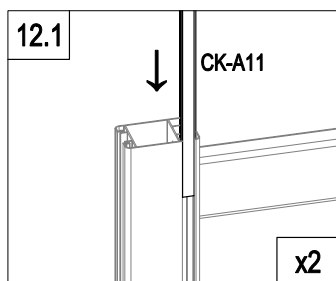
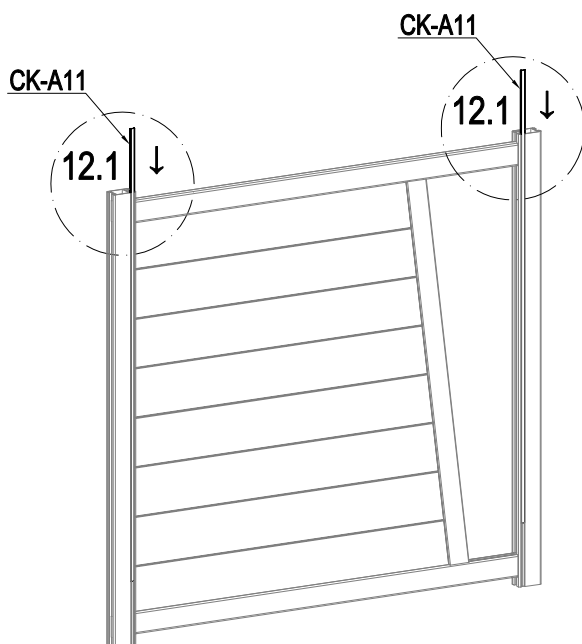

B

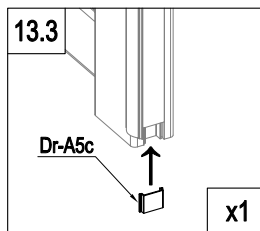
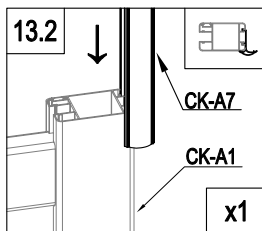
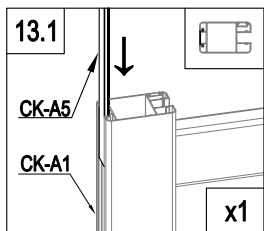
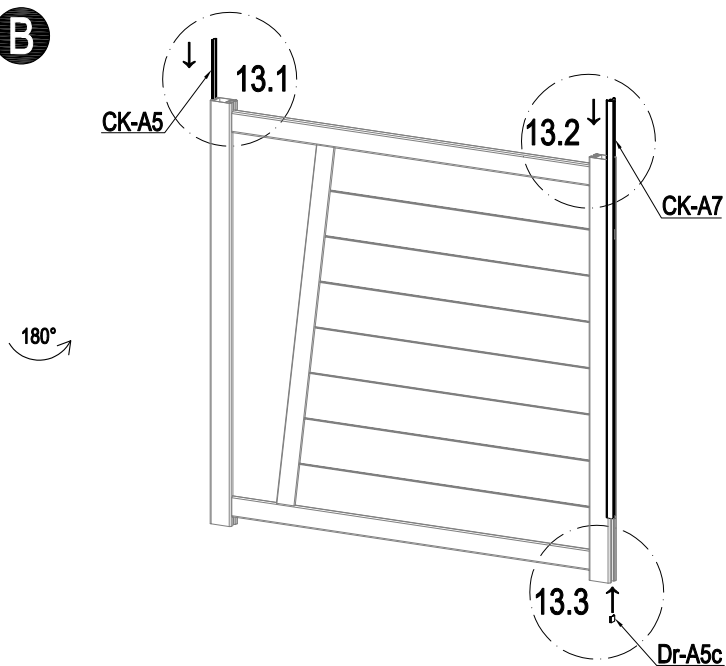

	CK-A11	2
---	--------	---

B





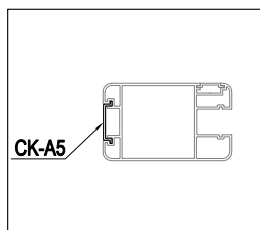

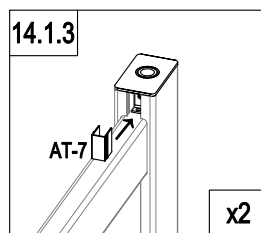
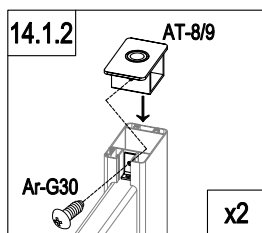
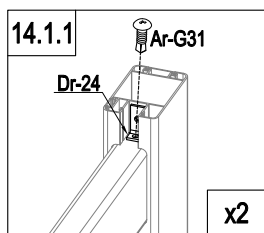
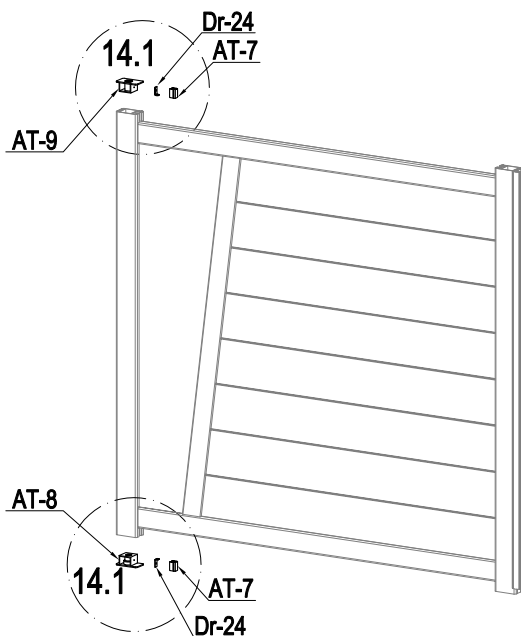

	CK-A5	1
	Dr-A5c	1
	CK-A7	1



B



	AT-8	1
	AT-9	1
	Dr-24	2

	AT-7	2
	Ar-G30	2
	Ar-G31	2

B

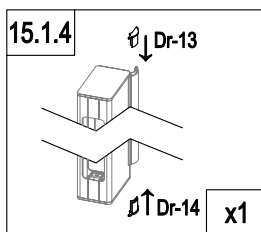
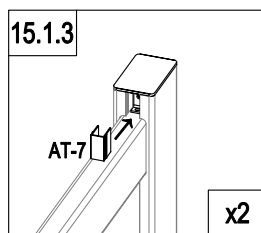
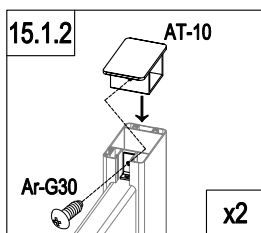
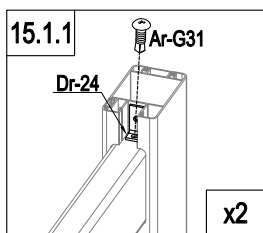
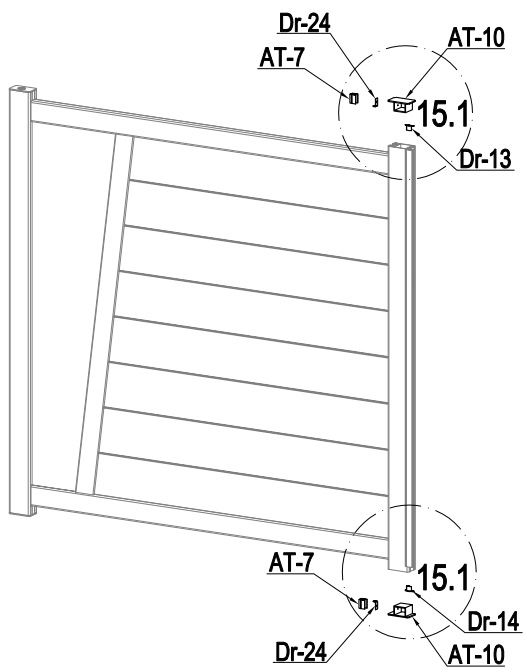



	AT-10	2
	Dr-24	2
	AT-7	2
	Dr-13	1

	Dr-14	1
	Ar-G30	2
	Ar-G31	2

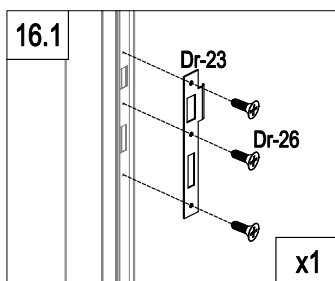
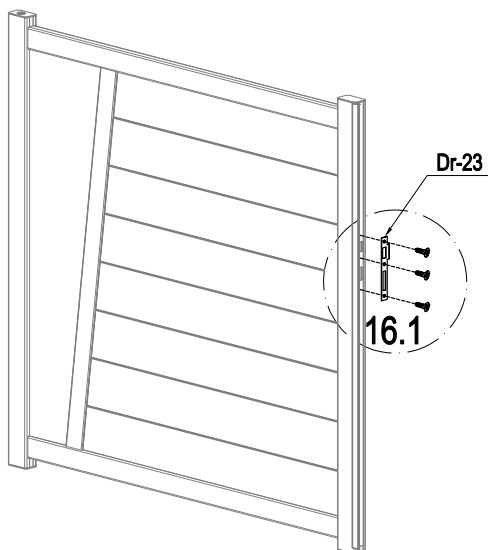

B

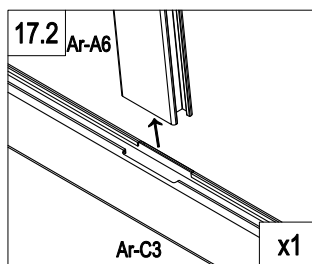
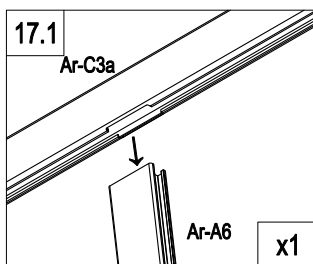
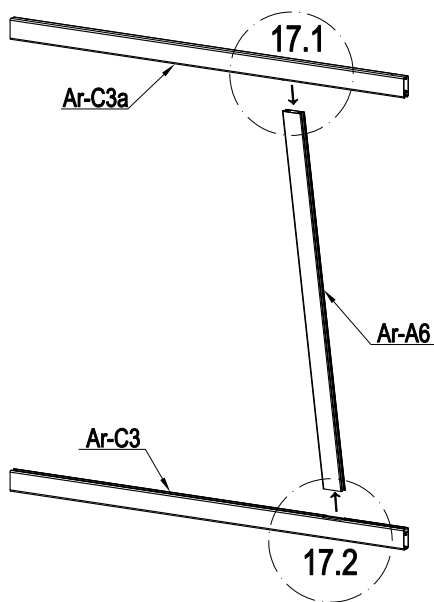

	Dr-23	1
	Dr-26	3

B



	Ar-A6	1
	Ar-C3	1
	Ar-C3a	1

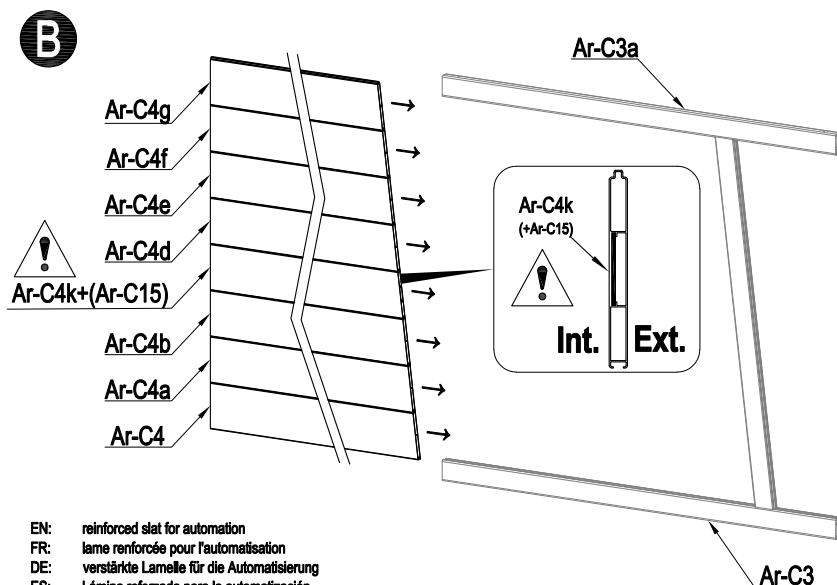

EN: reinforced slat for automation
FR: lame renforcée pour l'automatisation
DE: verstärkte Lamelle für die Automatisierung
ES: Lámina reforzada para la automatización
PT: ripa reforçada para automatização
IT: lamella rinforzata per l'automazione
NL: versterkte lat voor automatisering
PL: wzmocniona listwa do automatyzacji

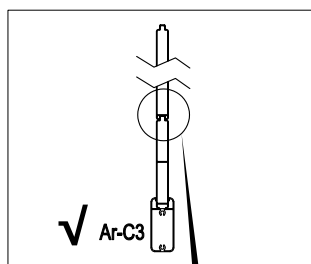
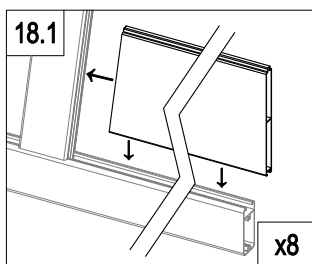

	Ar-C4	1
	Ar-C4a	1
	Ar-C4b	1
	Ar-C4d	1
	Ar-C4e	1

	Ar-C4e	1
	Ar-C4f	1
	Ar-C4g	1
Int. Ext.	Ar-C4k (+Ar-C15)	1

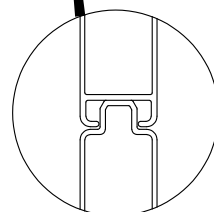

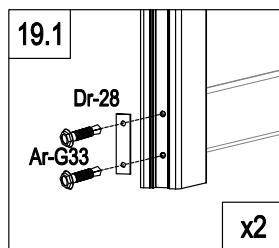
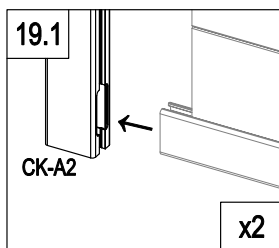
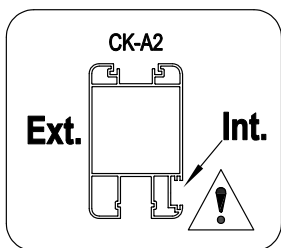
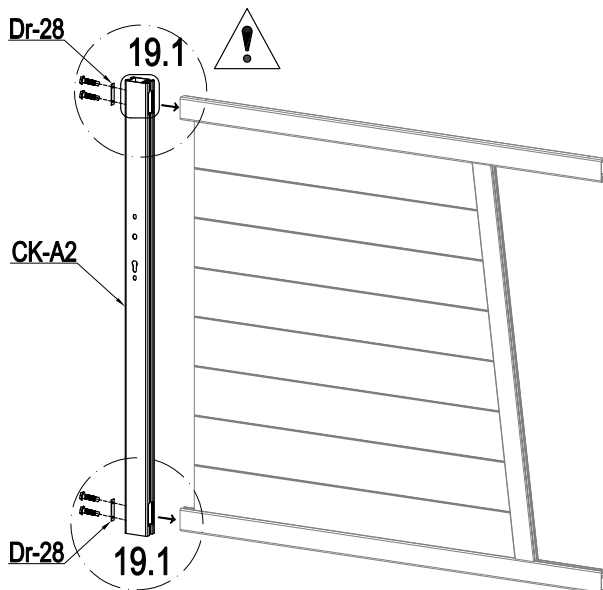

B

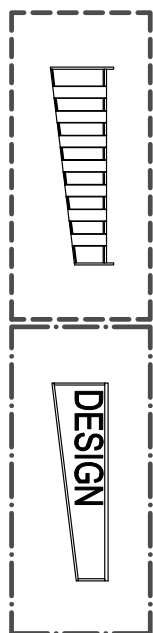
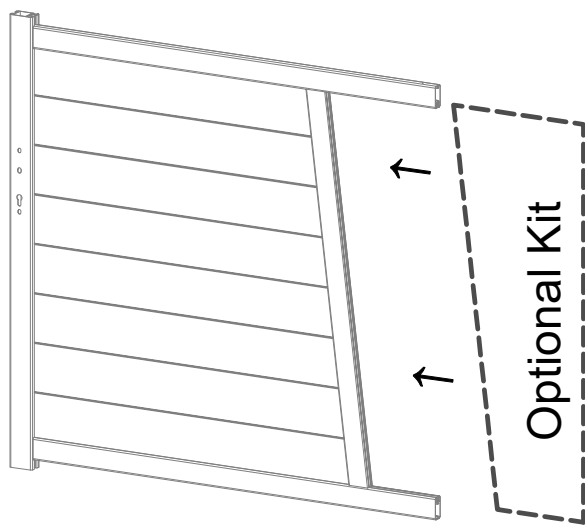

	CK-A2	1
	Dr-28	2
	Ar-G33	4

B



  P:63~67

  P:68~70

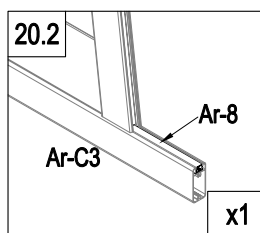
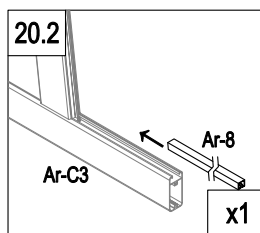
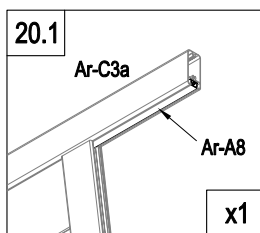
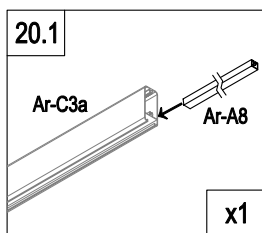
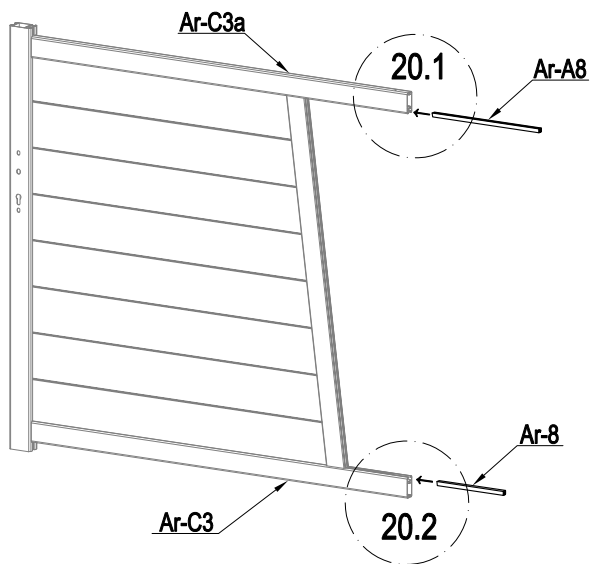

B

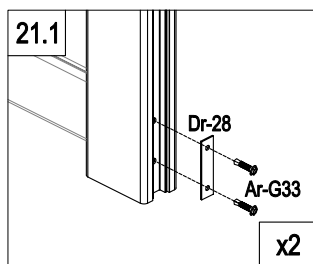
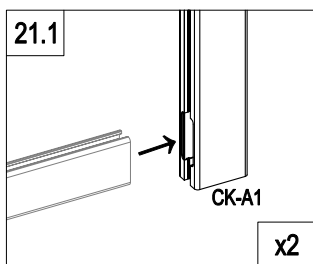
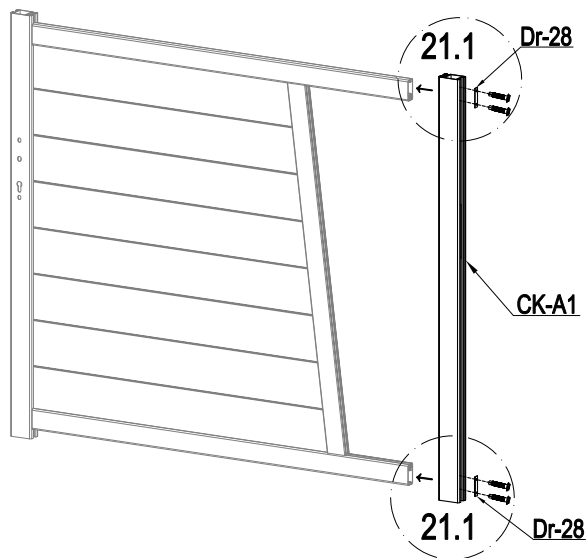

	Ar-8	1
	Ar-A8	1

B



	CK-A1	1
	Dr-28	2
	Ar-G33	4

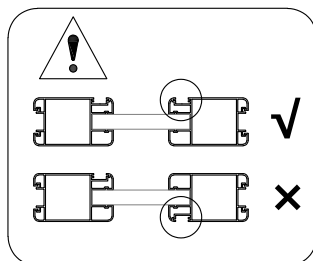

B

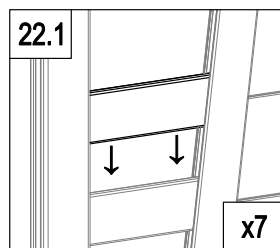
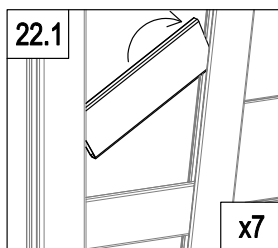
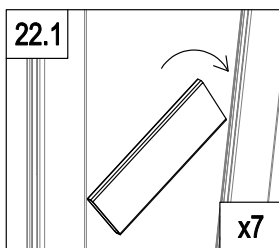
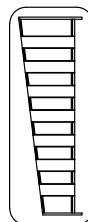
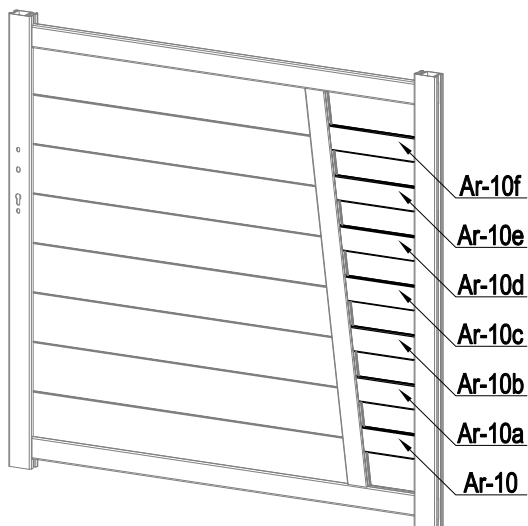



—	Ar-10	1
	Ar-10a	1
	Ar-10b	1
	Ar-10c	1

—	Ar-10d	1
	Ar-10e	1
	Ar-10f	1

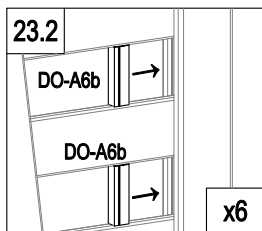
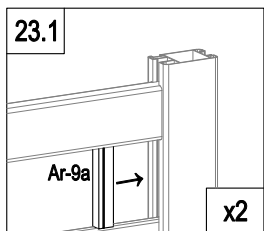
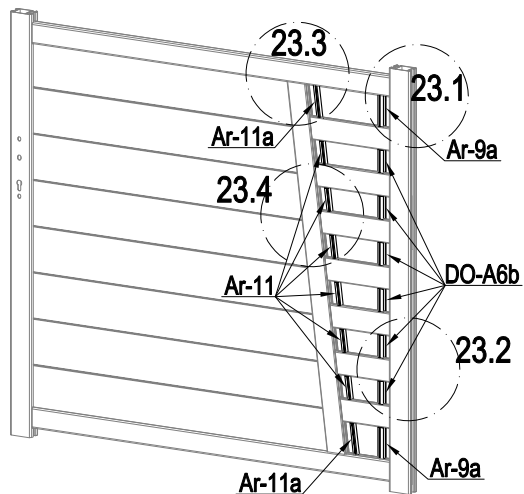
B



	DO-A6b	6
	Ar-9a	2
	Ar-11	6
	Ar-11a	2

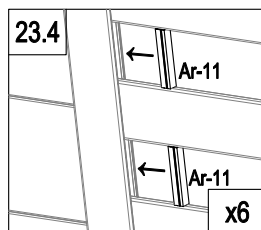

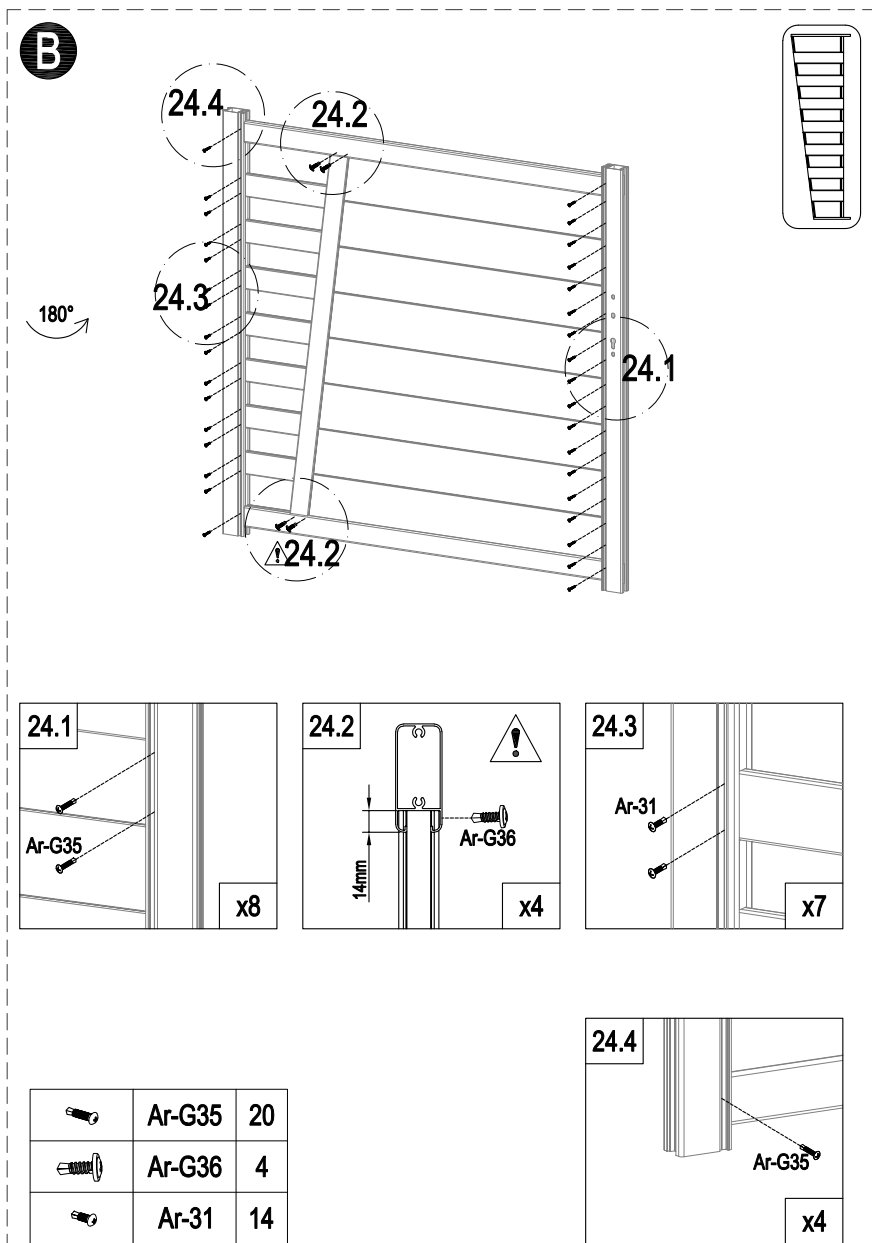

B

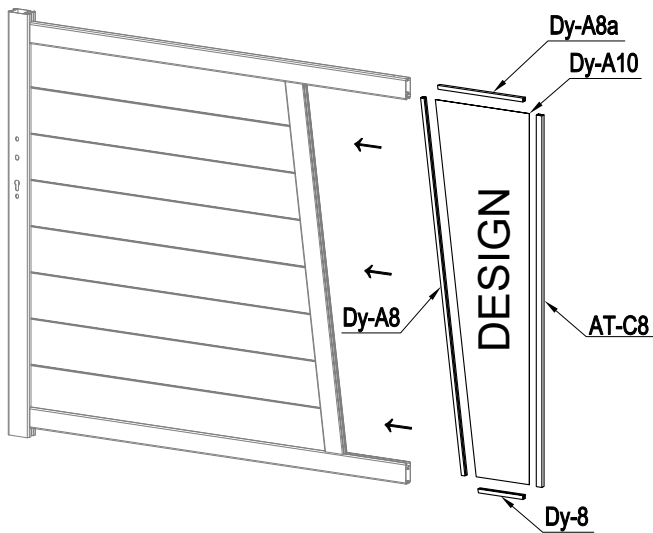

DESIGN

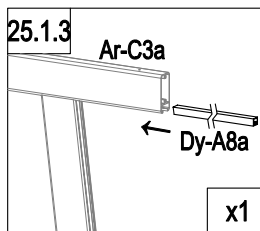
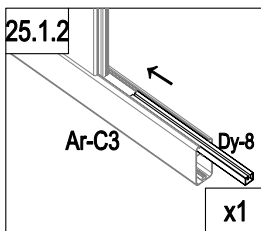
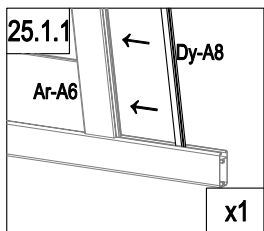



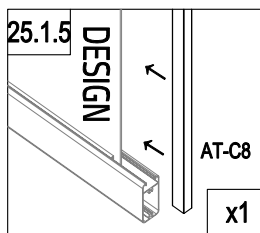
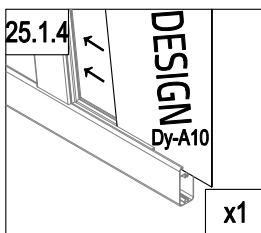

□	Dy-A8	1
	Dy-A8a	1
	Dy-8	1
▤	AT-C8	1
DESIGN	Dy-A10	1

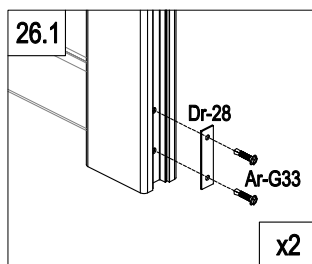
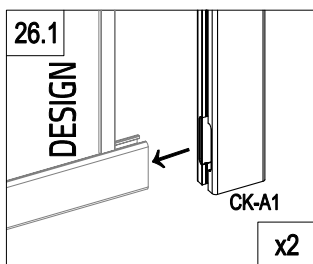
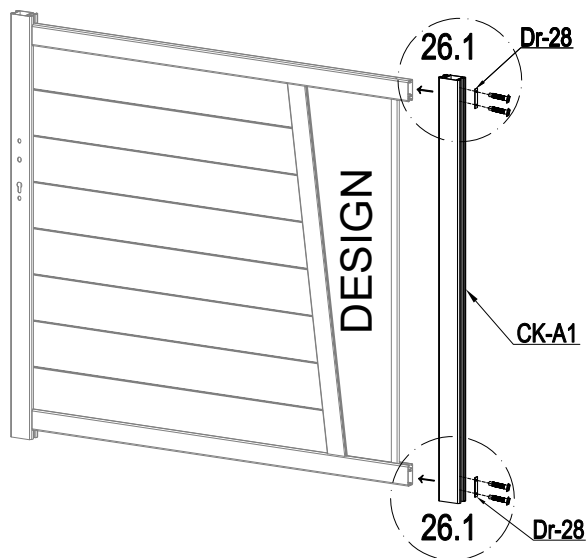

B

DESIGN



	CK-A1	1
	Dr-28	2
	Ar-G33	4

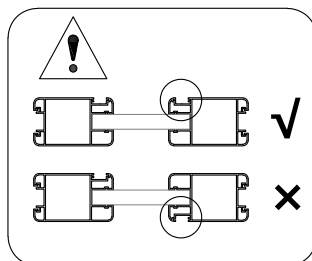

B

DESIGN

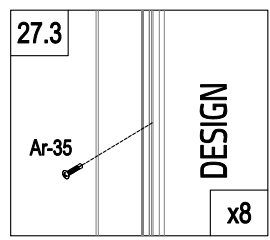
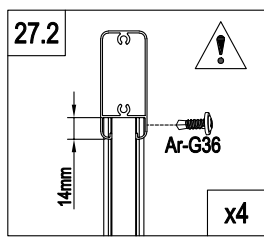
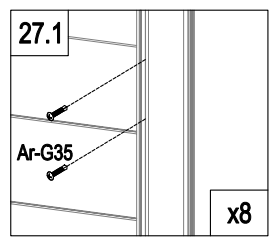
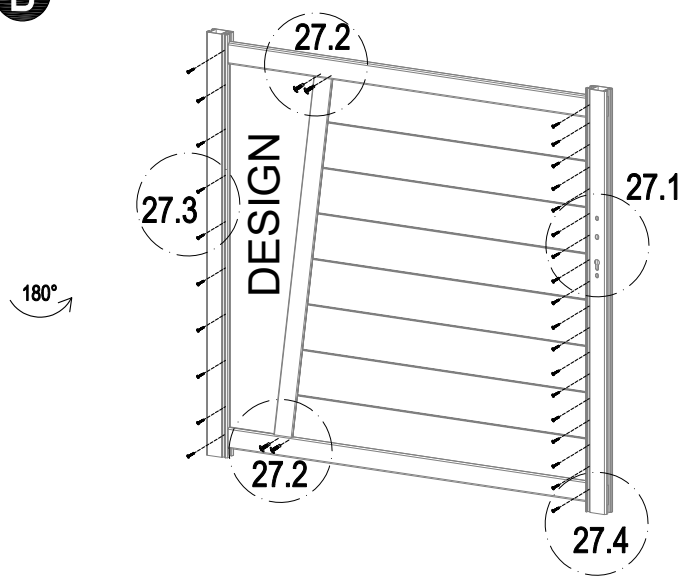

	Ar-G35	20
	Ar-G36	4
	Ar-35	8

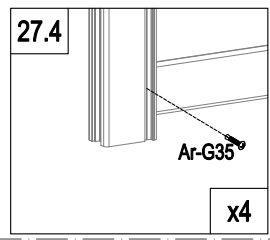

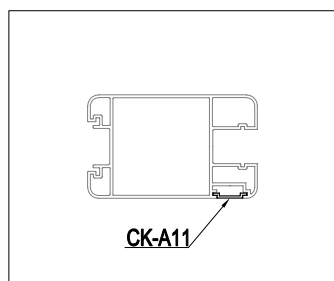
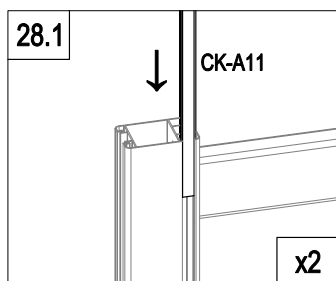
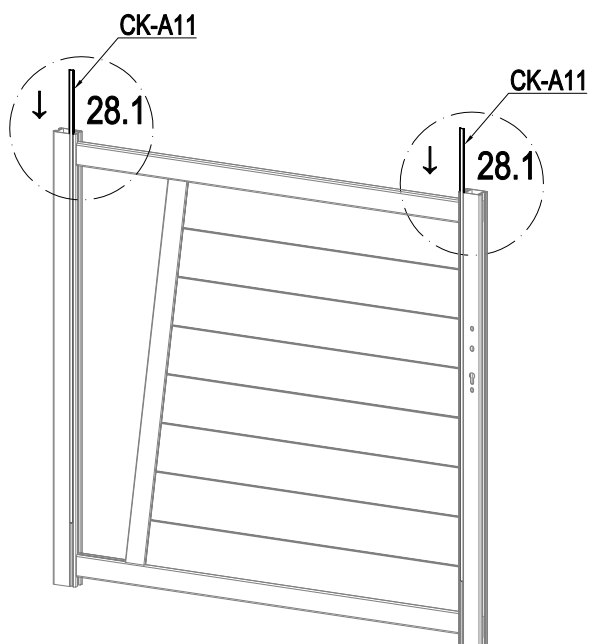

B

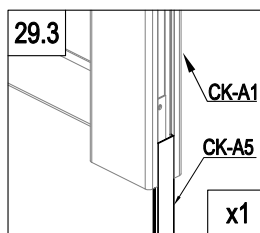
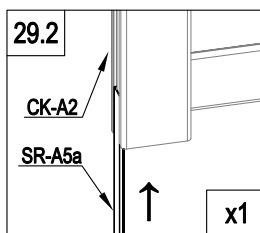
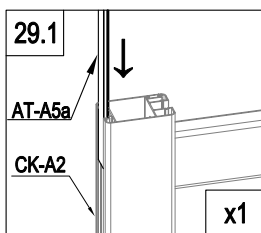
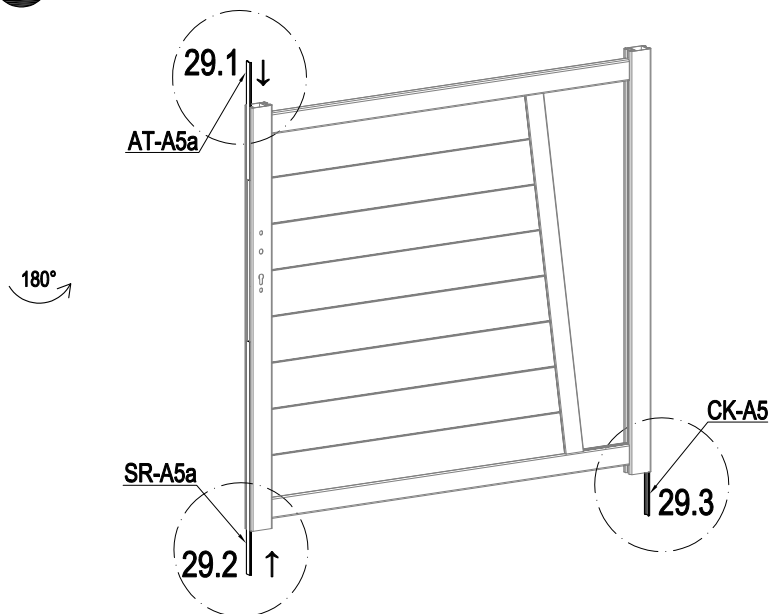

	CK-A11	2
---	--------	---

B



	CK-A5	1
	AT-A5a	1
	SR-A5a	1

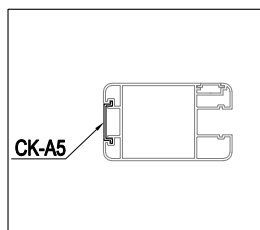

B

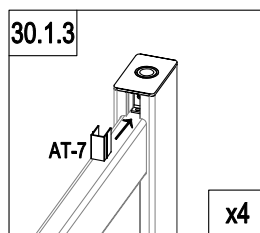
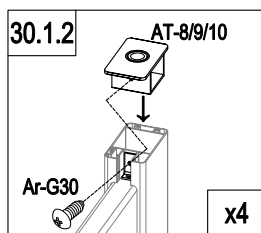
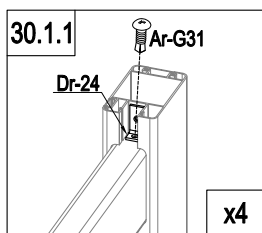
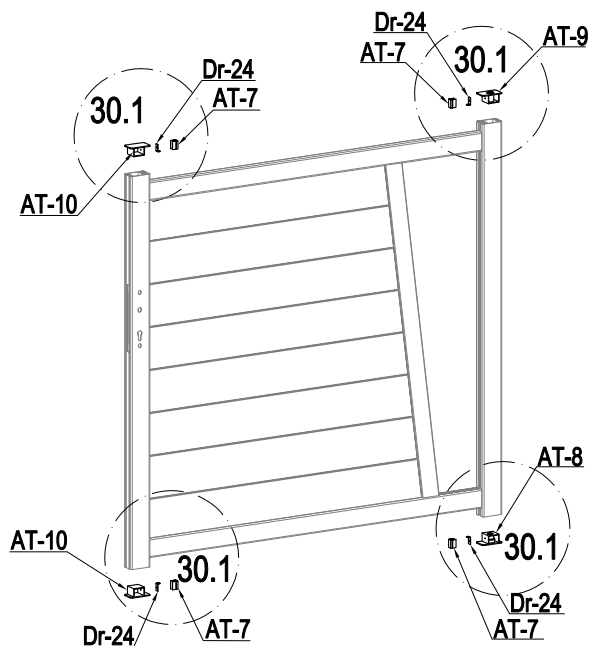

	AT-8	1
	AT-9	1
	AT-10	2
	Dr-24	4

	AT-7	4
	Ar-G30	4
	Ar-G31	4

B

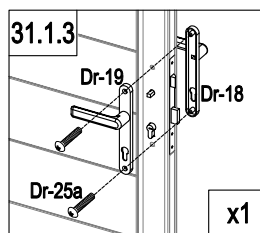
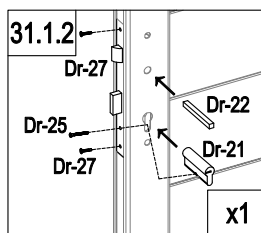
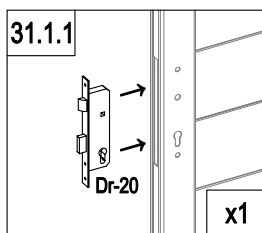
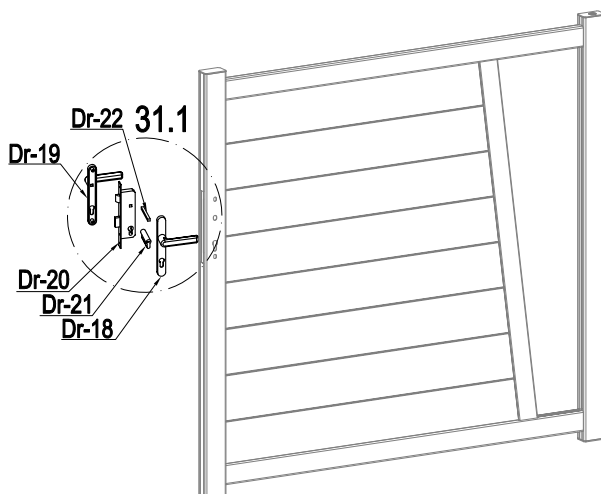



	Dr-20	1
	Dr-21	1
	Dr-22	1
	Dr-25	1

	Dr-18	1
	Dr-19	1
	Dr-25a	2
	Dr-27	2

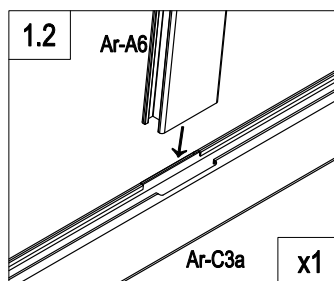
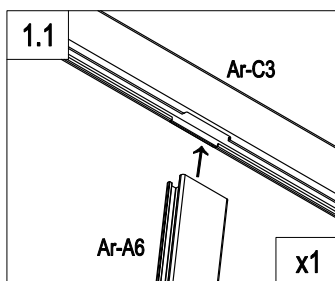
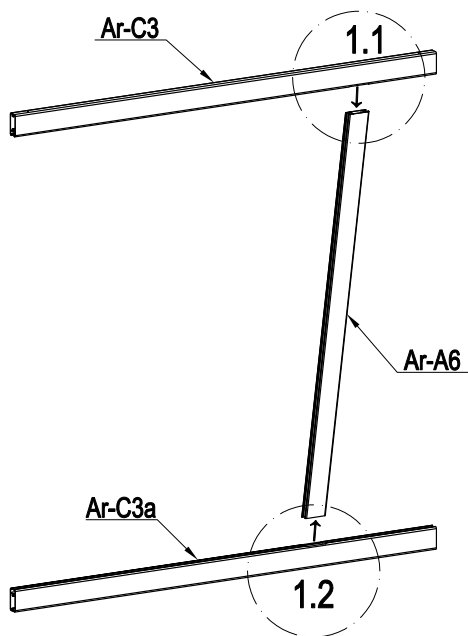
C



	Ar-A6	1
	Ar-C3	1
	Ar-C3a	1

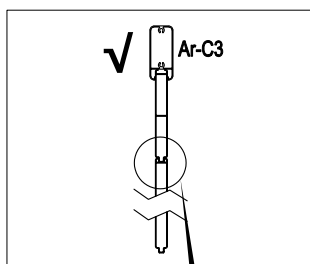
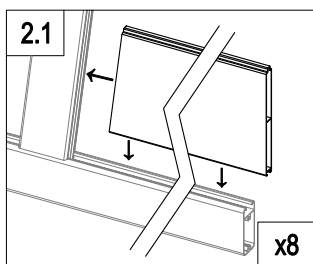
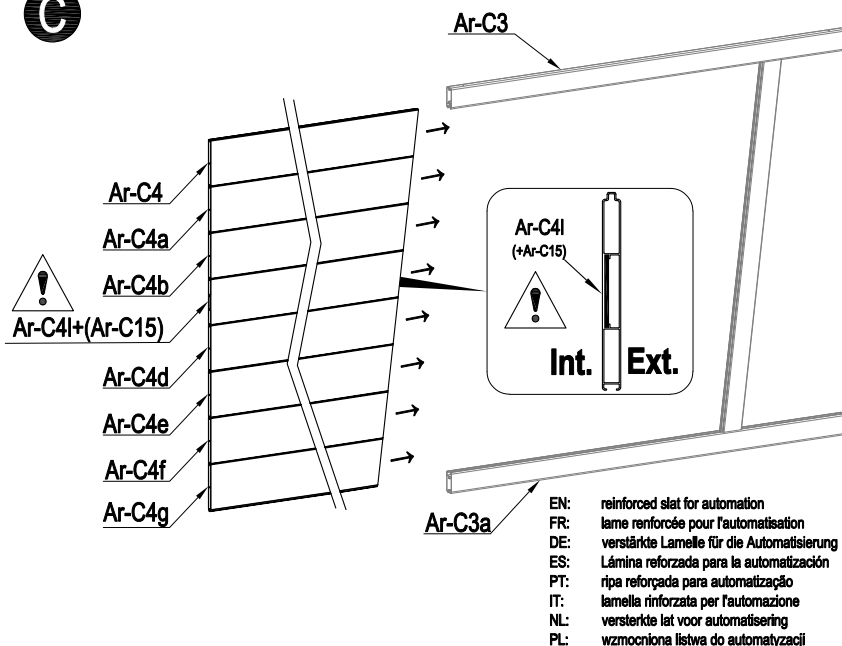



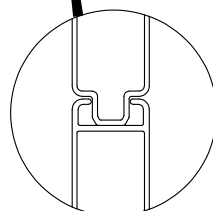

	Ar-C4	1
	Ar-C4a	1
	Ar-C4b	1
	Ar-C4d	1

	Ar-C4e	1
	Ar-C4f	1
	Ar-C4g	1
Int. Ext.	Ar-C4I (+Ar-C15)	1

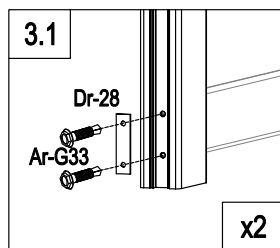
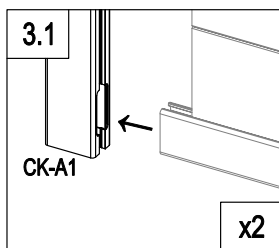
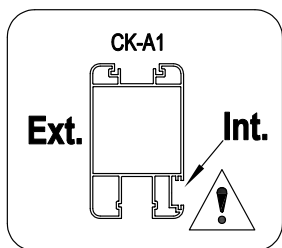
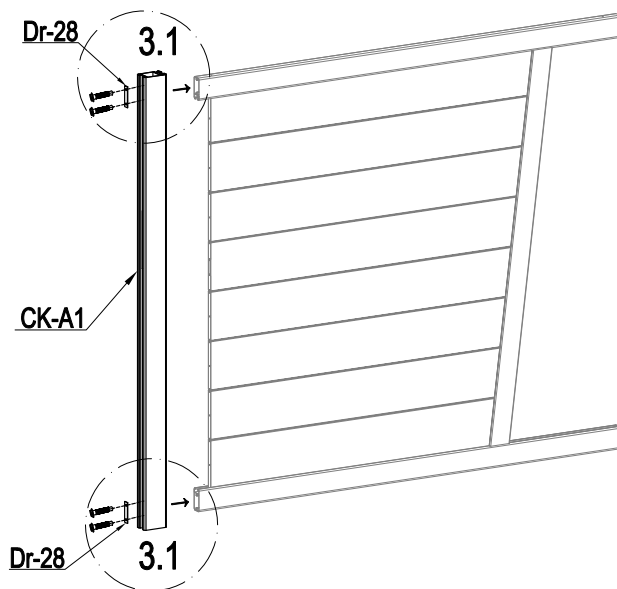



C



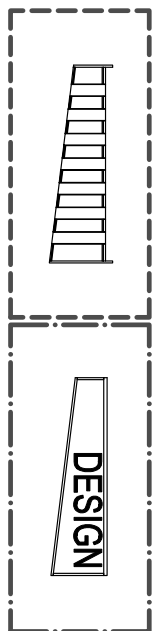
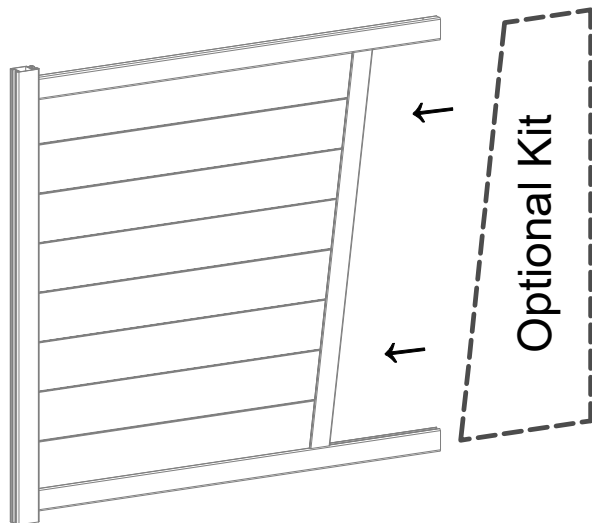

	CK-A1	1
	Dr-28	2
	Ar-G33	4

C



  P:79~83

  P:84~86

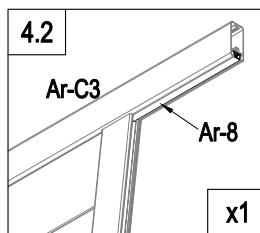
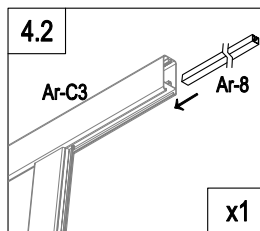
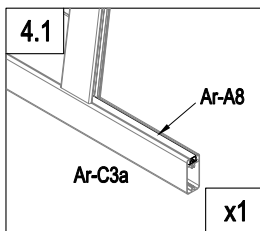
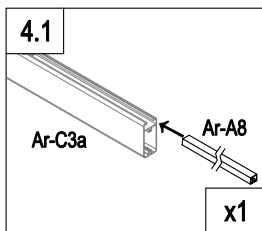
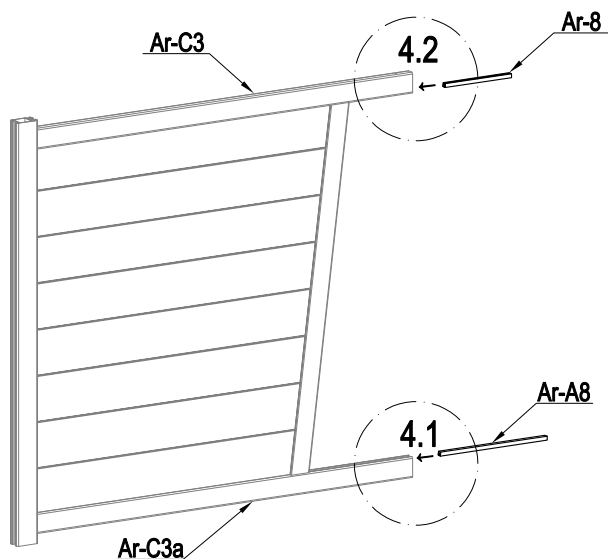

C

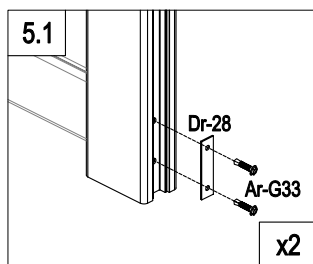
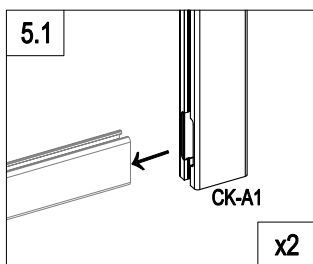
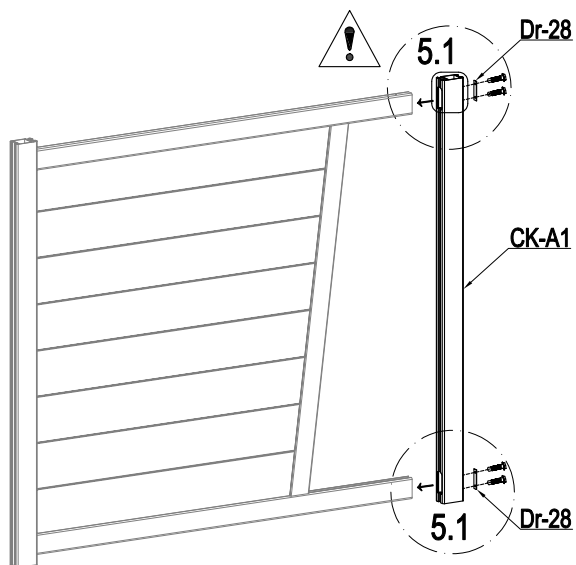

	Ar-8	1
	Ar-A8	1

C



	CK-A1	1
	Dr-28	2
	Ar-G33	4

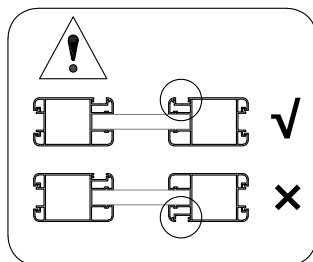

C

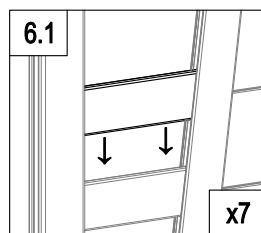
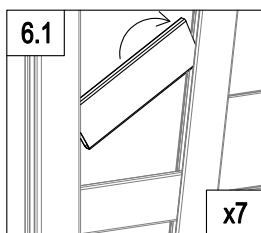
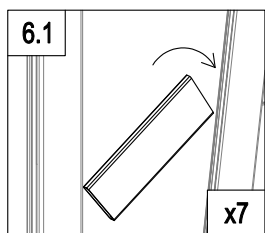
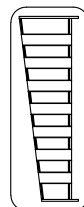
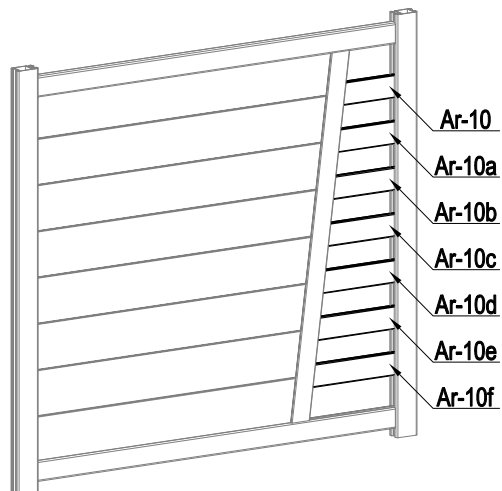



—	Ar-10	1
	Ar-10a	1
	Ar-10b	1
	Ar-10c	1

—	Ar-10d	1
	Ar-10e	1
	Ar-10f	1

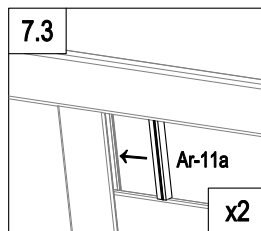
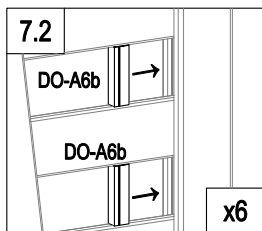
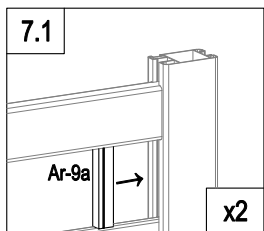
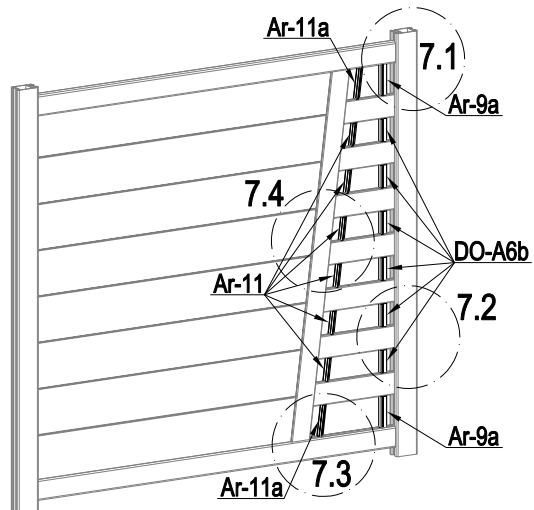
C



	DO-A6b	6
	Ar-9a	2
	Ar-11	6
	Ar-11a	2

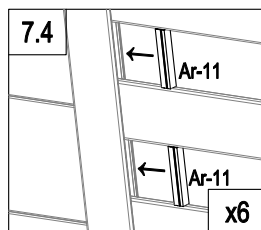

C

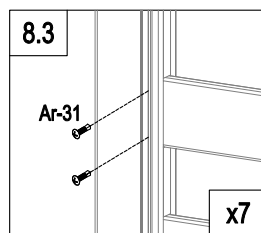
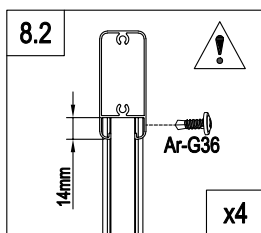
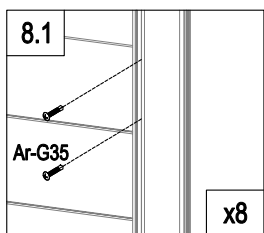
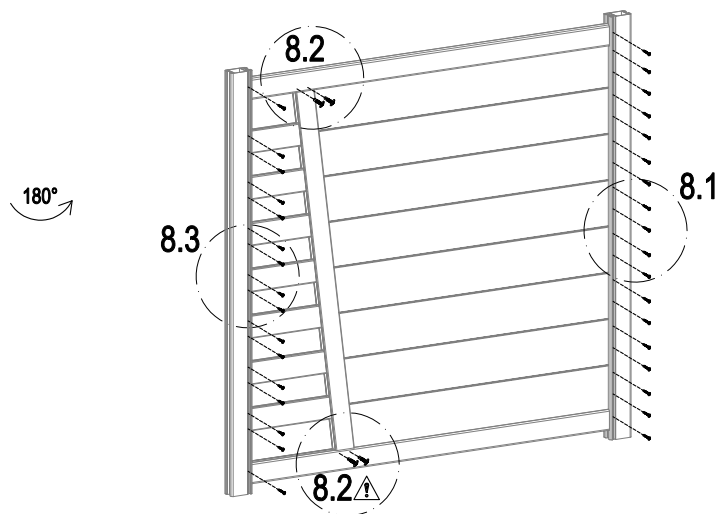
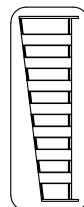

	Ar-G35	20
	Ar-G36	4
	Ar-31	14

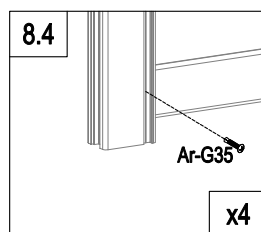

C

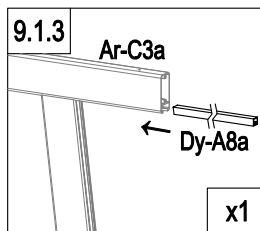
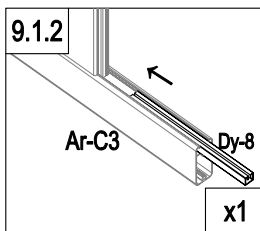
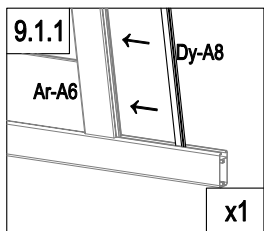
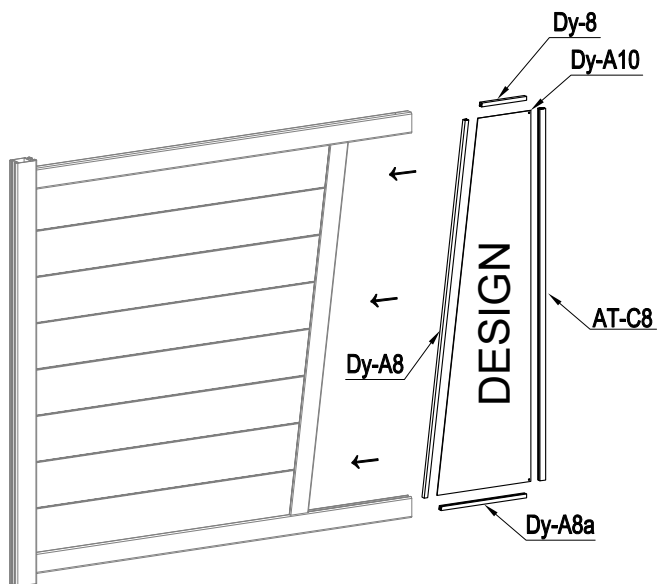

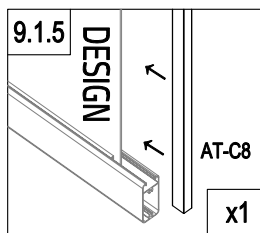
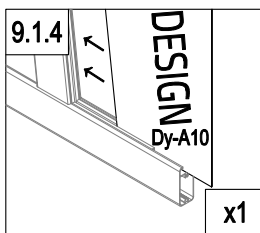

□	Dy-A8	1
	Dy-A8a	1
	Dy-8	1
▤	AT-C8	1
DESIGN	Dy-A10	1

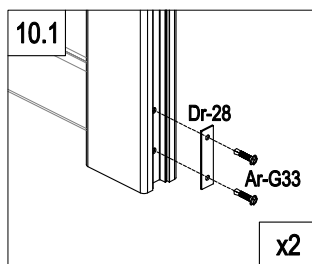
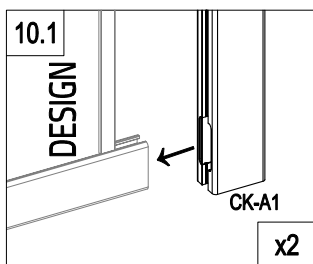
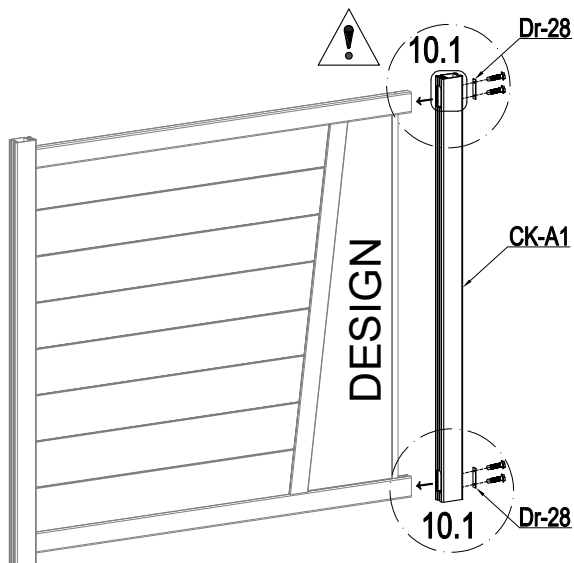

C



	CK-A1	1
	Dr-28	2
	Ar-G33	4

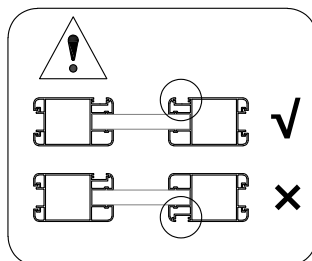

DESIGN

C

DESIGN

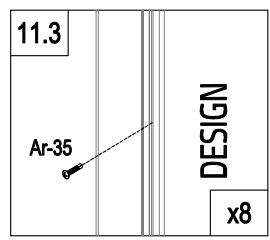
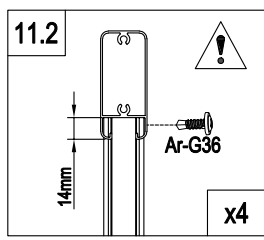
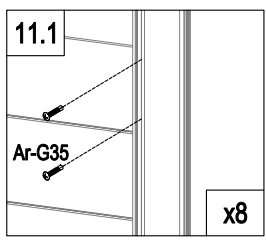
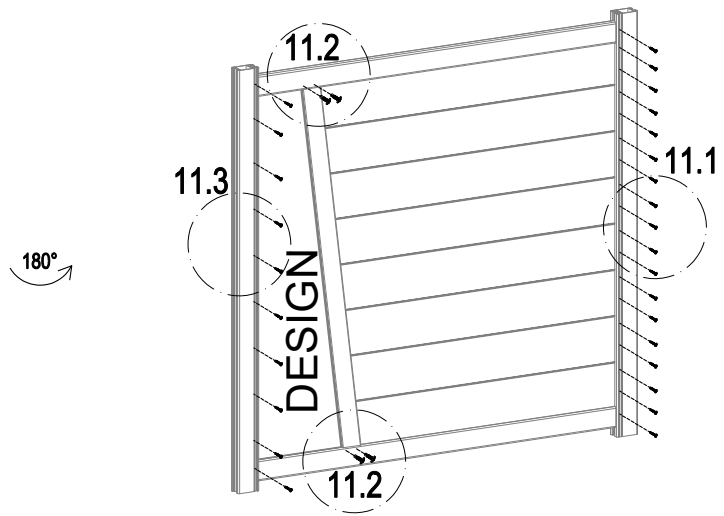

	Ar-G35	20
	Ar-G36	4
	Ar-35	8

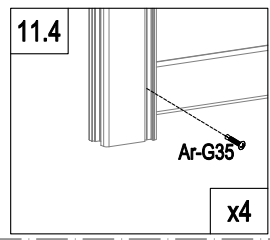

C

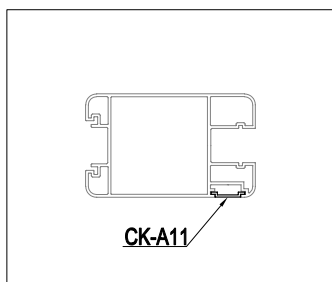
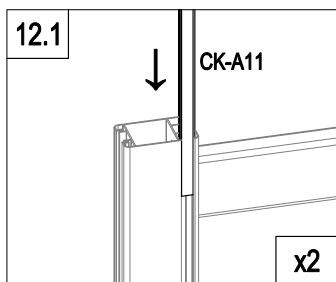
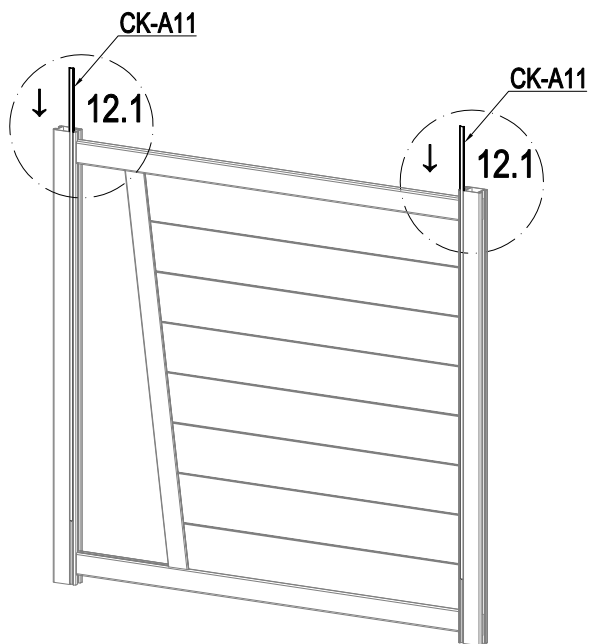

	CK-A11	2
---	--------	---

C

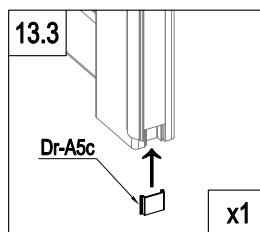
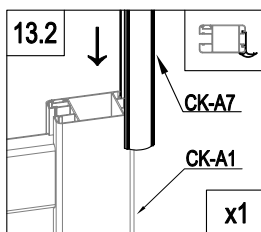
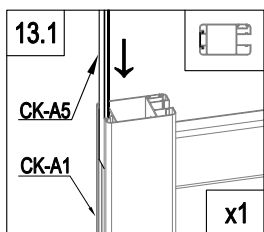
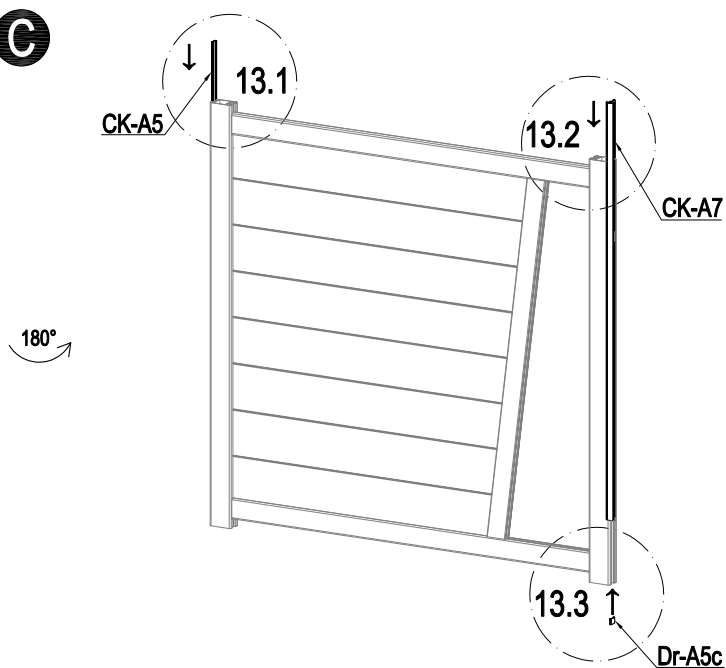



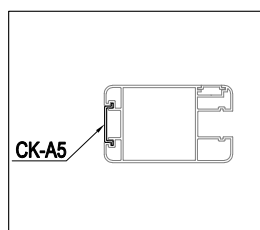

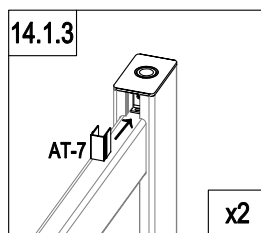
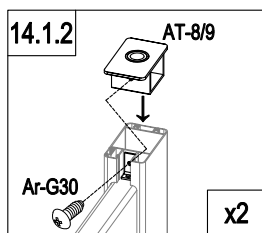
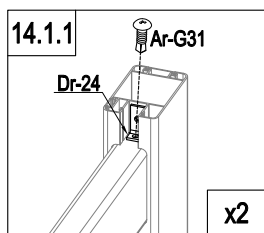
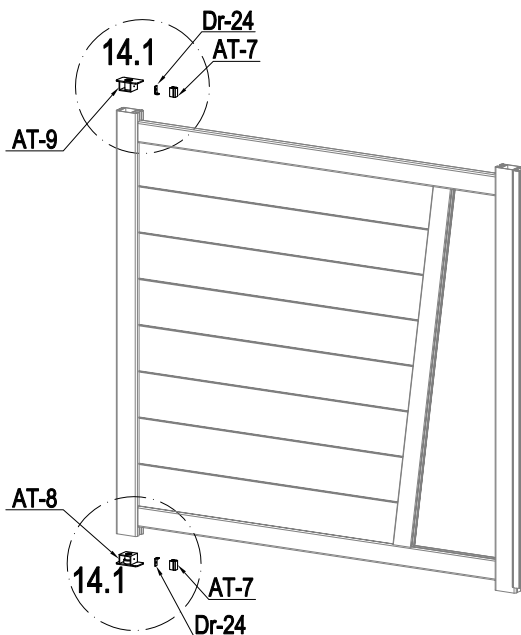

	CK-A5	1
	Dr-A5c	1
	CK-A7	1



C



	AT-8	1
	AT-9	1
	Dr-24	2

	AT-7	2
	Ar-G30	2
	Ar-G31	2

C

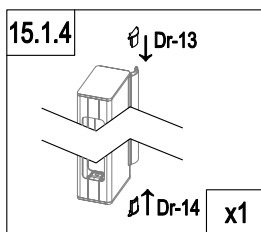
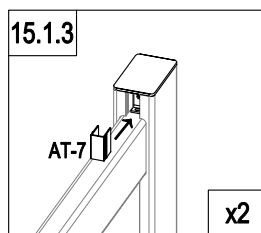
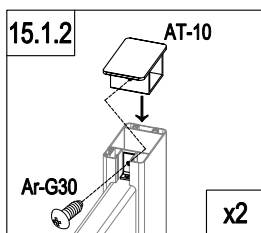
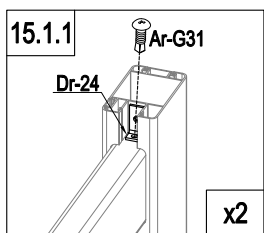
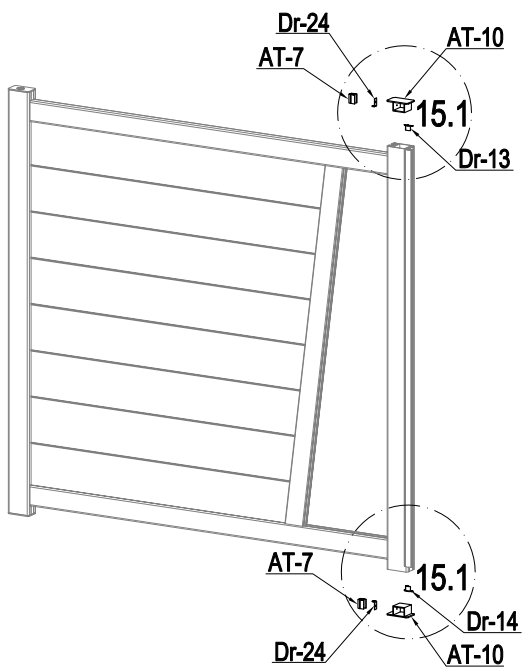



	AT-10	2
	Dr-24	2
	AT-7	2
	Dr-13	1

	Dr-14	1
	Ar-G30	2
	Ar-G31	2

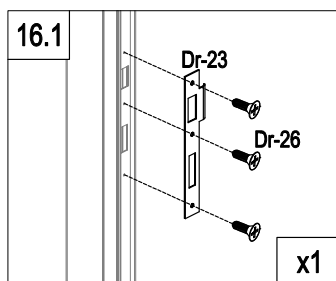
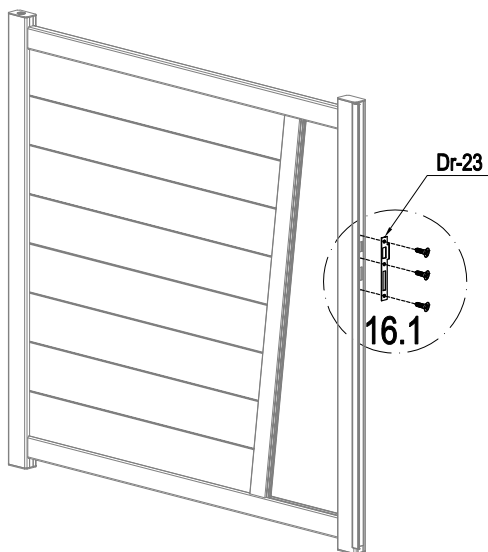

C

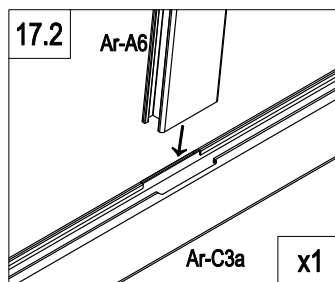
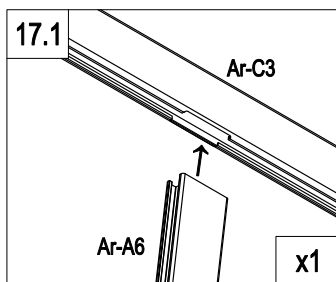
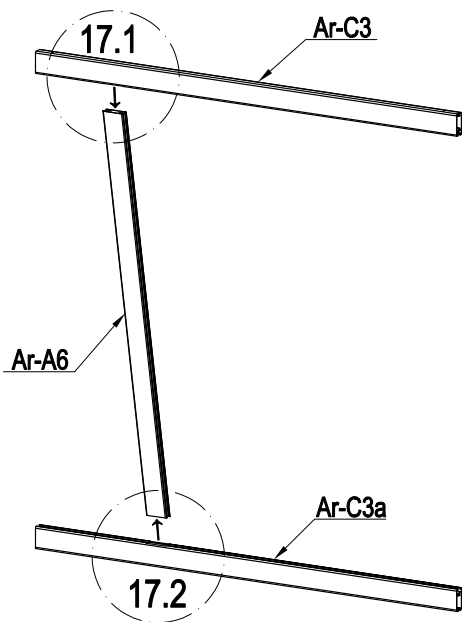

	Dr-23	1
	Dr-26	3

C



	Ar-A6	1
	Ar-C3	1
	Ar-C3a	1

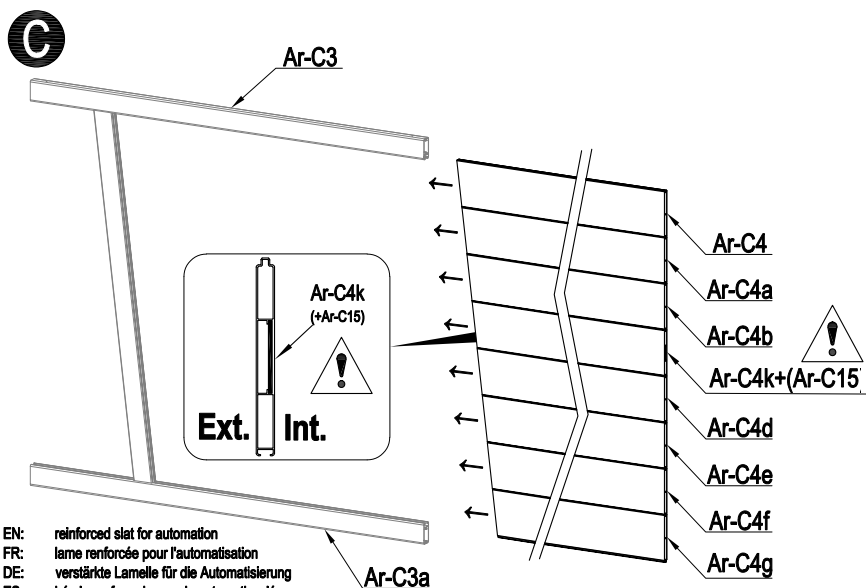

- EN: reinforced slat for automation
 FR: lame renforcée pour l'automatisation
 DE: verstärkte Lamelle für die Automatisierung
 ES: Lámina reforzada para la automatización
 PT: ripa reforçada para automatização
 IT: lamella rinforzata per l'automazione
 NL: versterkte lat voor automatisering
 PL: wzmocniona listwa do automatyzacji

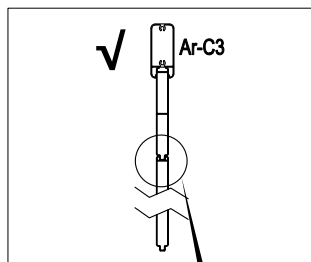
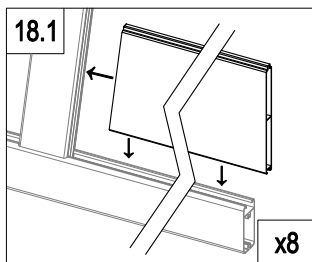



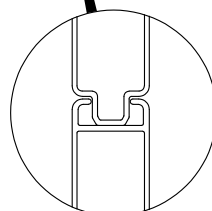

	Ar-C4	1
	Ar-C4a	1
	Ar-C4b	1
	Ar-C4d	1

	Ar-C4e	1
	Ar-C4f	1
	Ar-C4g	1
Int. 	Ar-C4k (+Ar-C15)	1
Ext.		

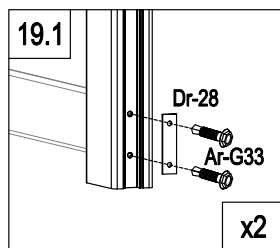
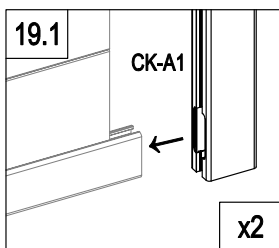
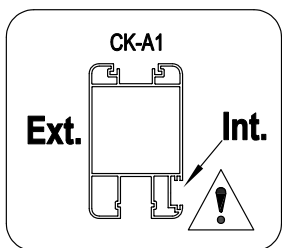
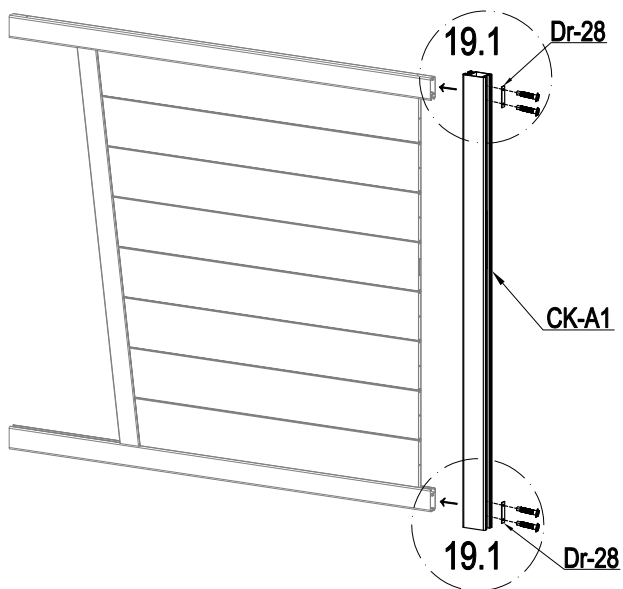



C



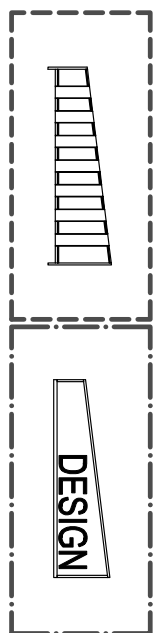
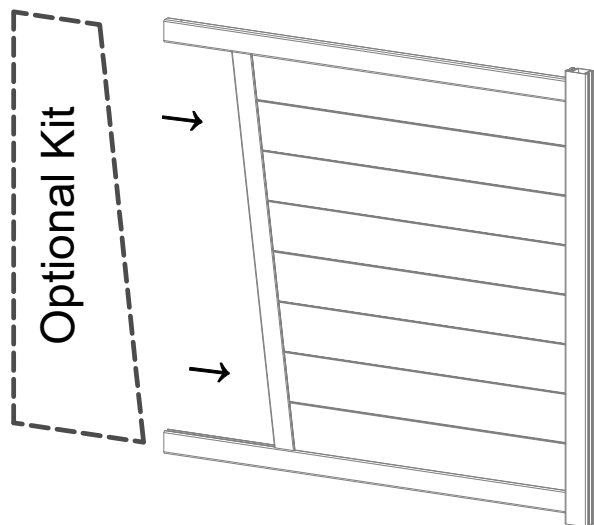

	CK-A1	1
	Dr-28	2
	Ar-G33	4

C





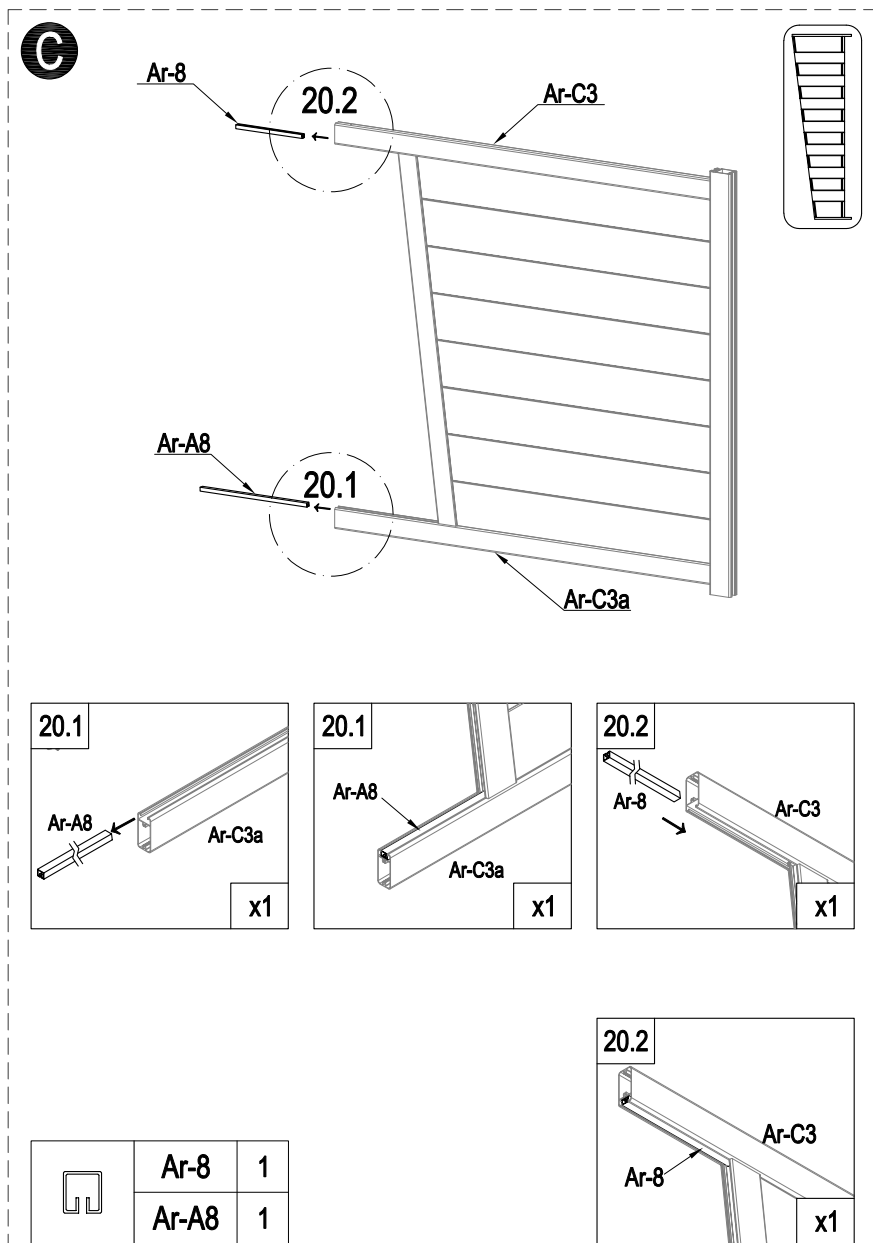

 P:96~100

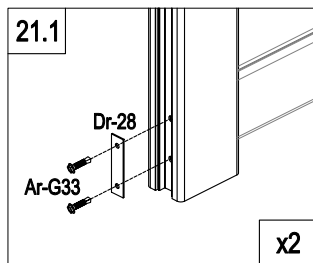
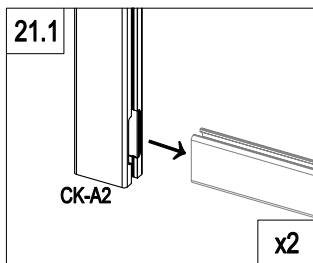
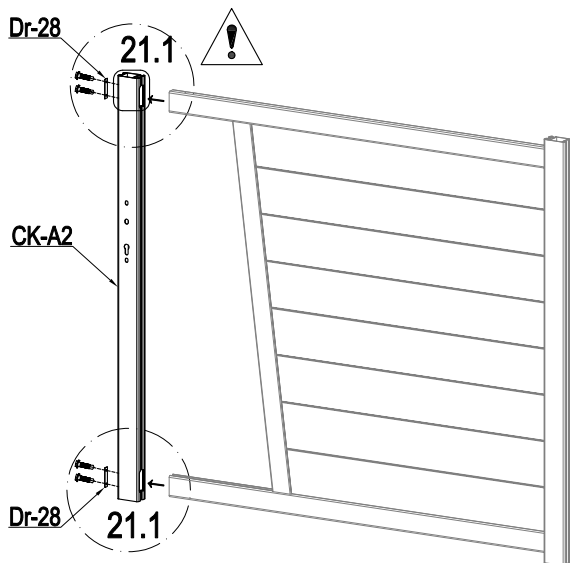

 P:101~103



C

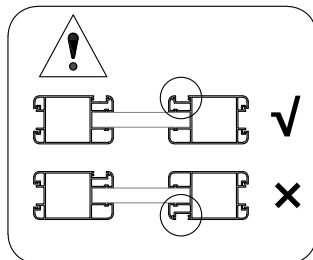

	CK-A2	1
	Dr-28	2
	Ar-G33	4



C

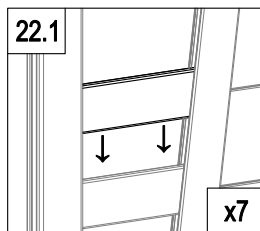
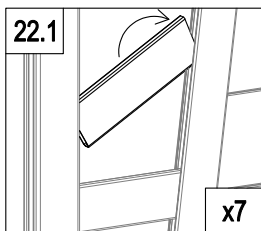
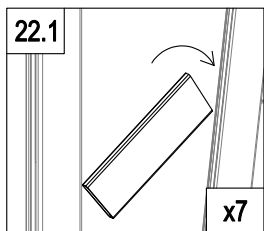
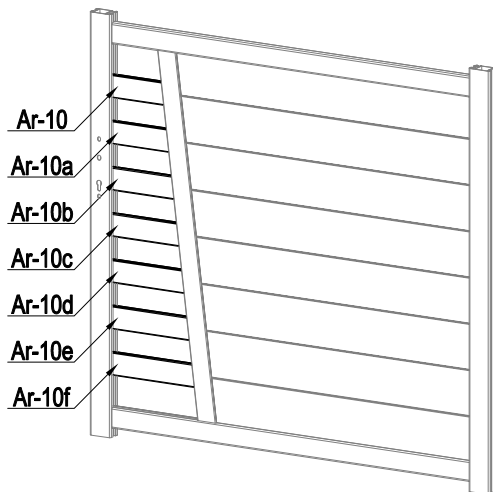
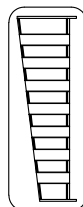

—	Ar-10	1
	Ar-10a	1
	Ar-10b	1
	Ar-10c	1

—	Ar-10d	1
	Ar-10e	1
	Ar-10f	1

C

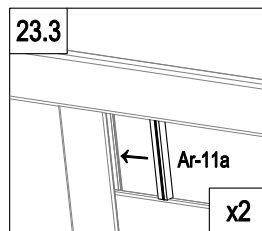
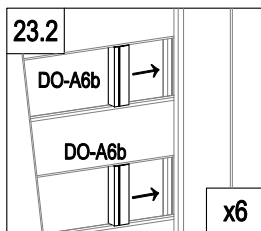
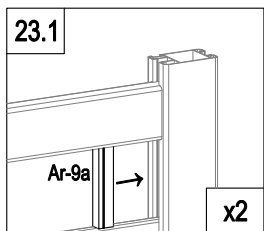
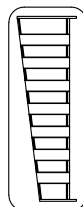
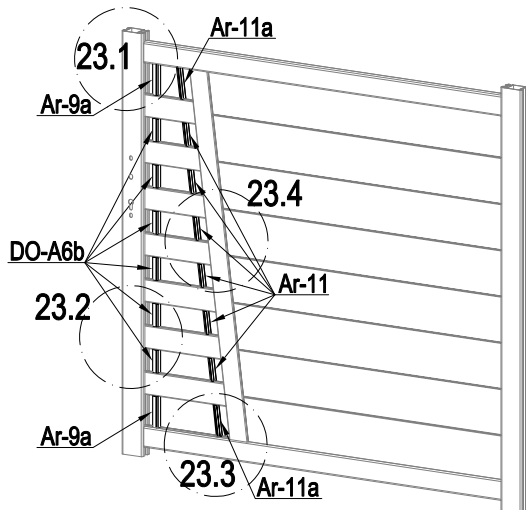

	DO-A6b	6
	Ar-9a	2
	Ar-11	6
	Ar-11a	2

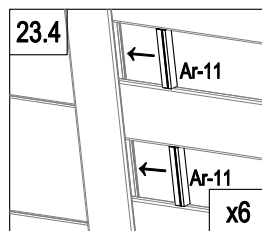

C

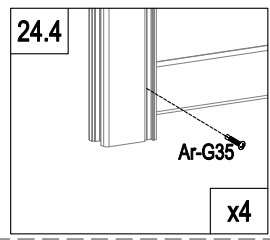
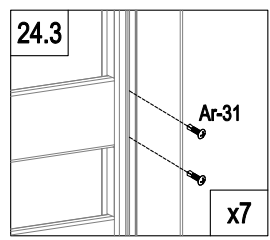
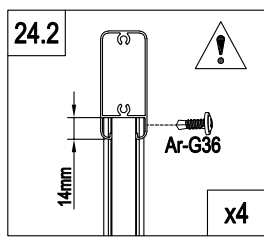
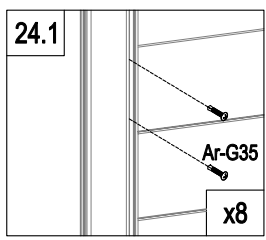
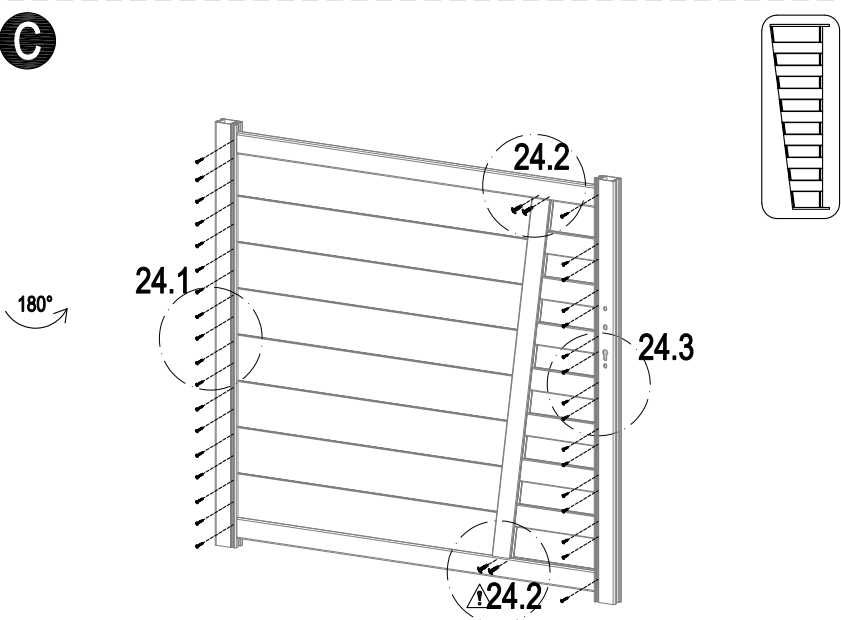

	Ar-G35	20
	Ar-G36	4
	Ar-31	14

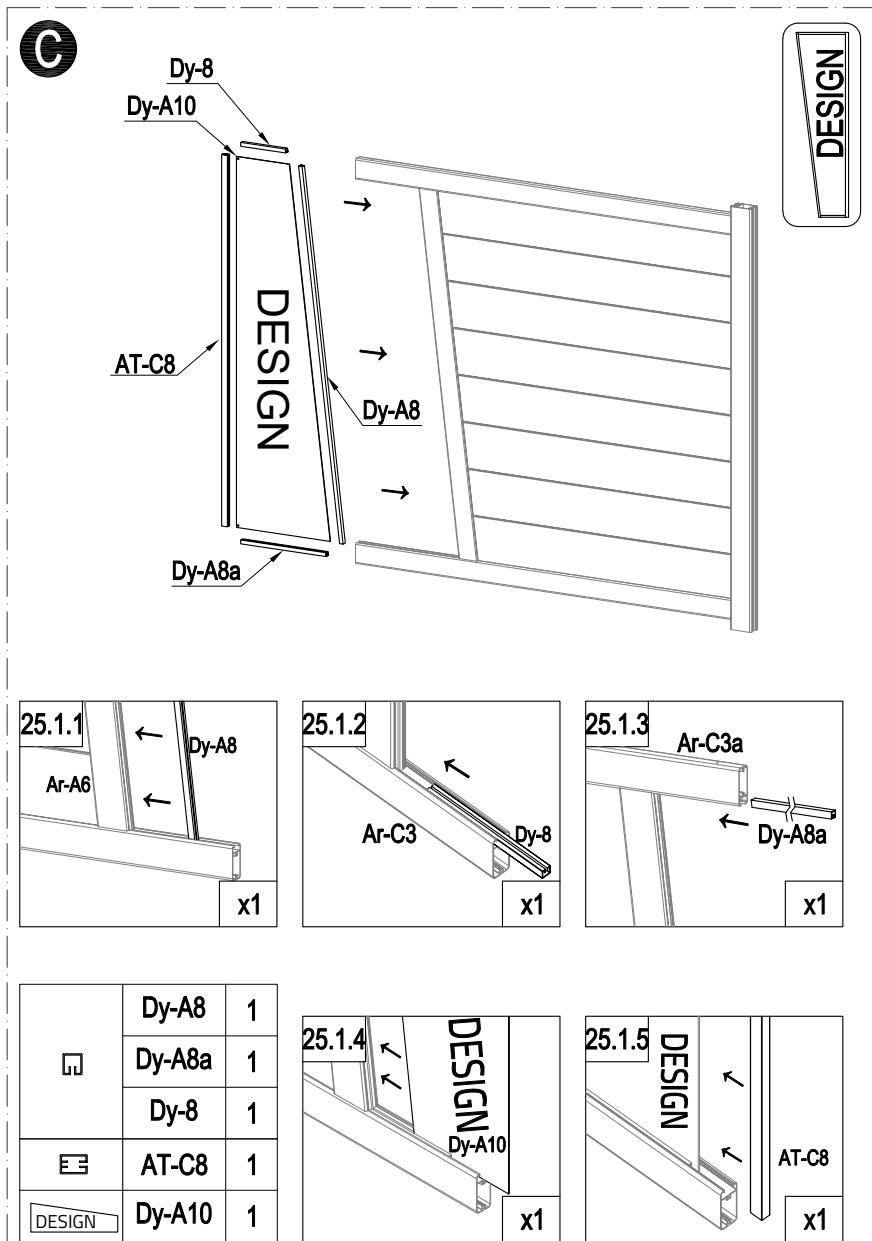

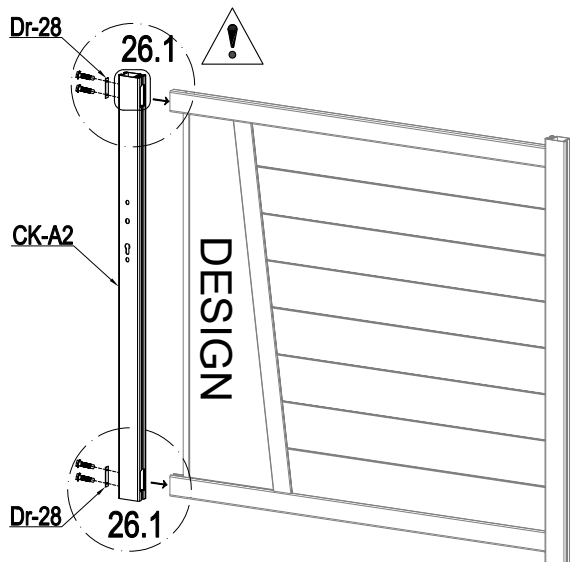

C

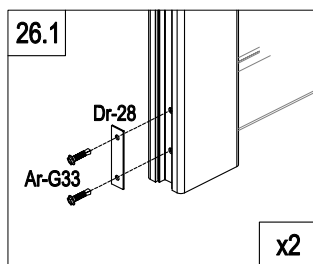
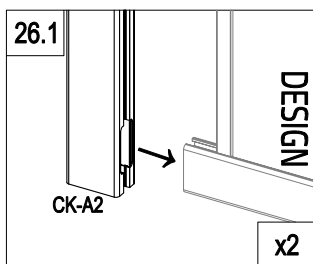

DESIGN



	CK-A2	1
	Dr-28	2
	Ar-G33	4

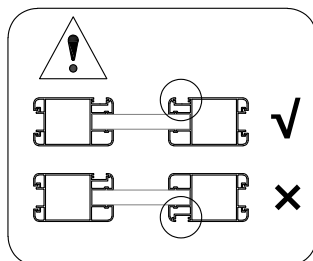

C

DESIGN

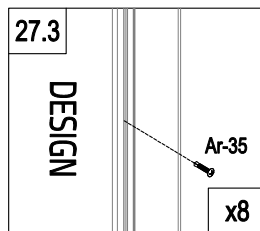
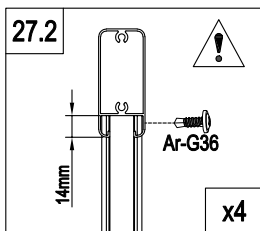
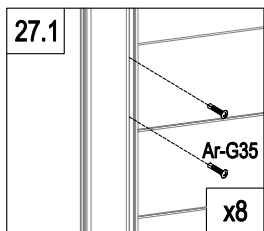
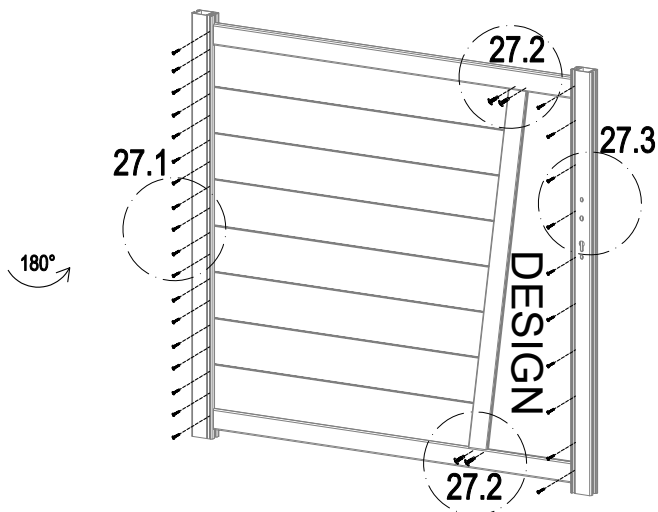

	Ar-G35	20
	Ar-G36	4
	Ar-35	8

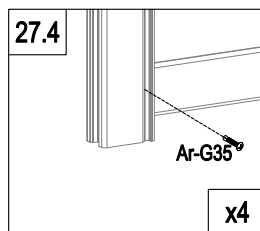

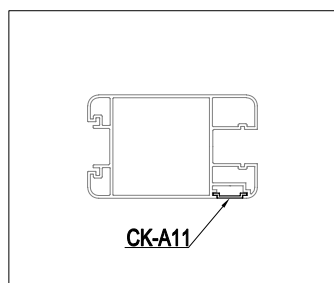
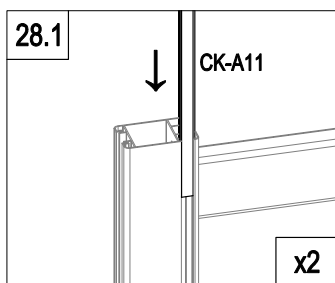
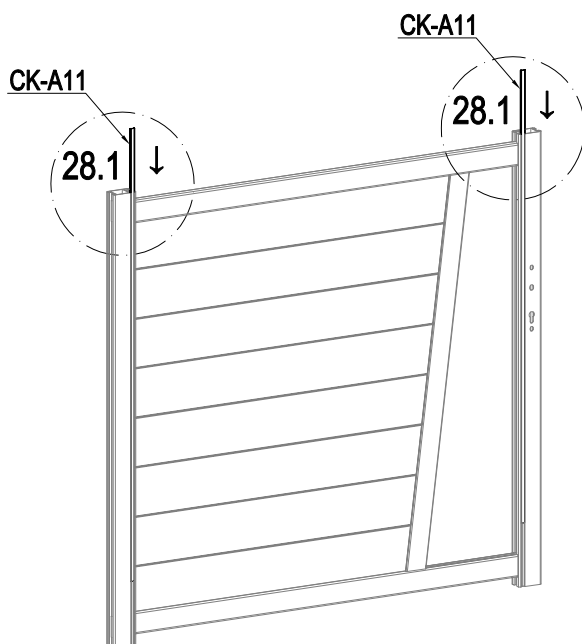

C

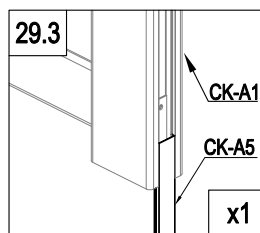
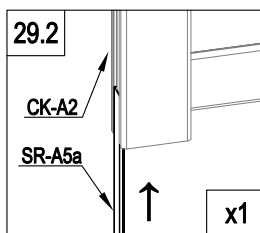
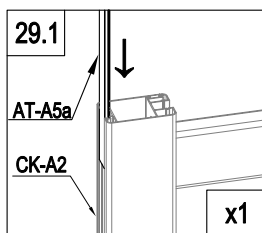
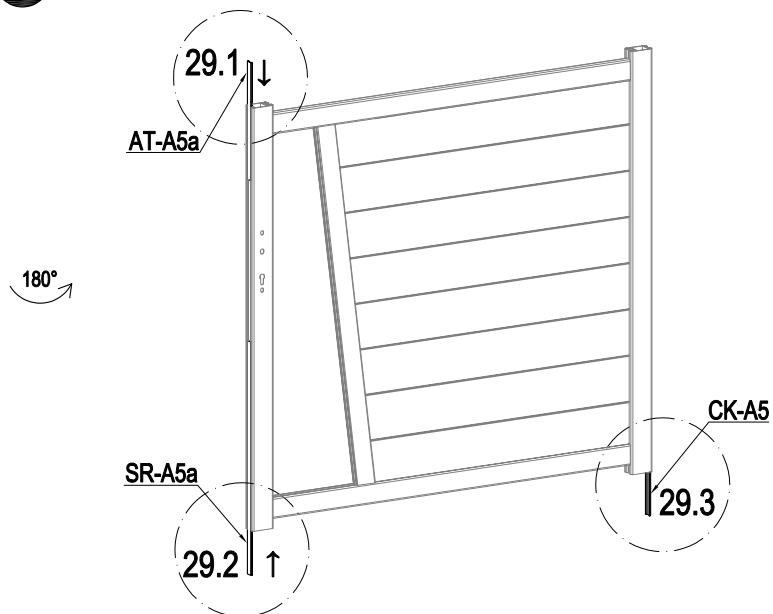

	CK-A11	2
---	--------	---

C



	CK-A5	1
	AT-A5a	1
	SR-A5a	1

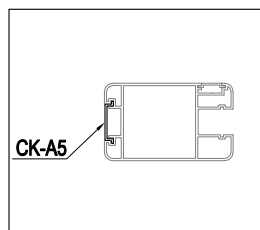

C

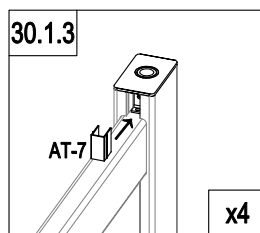
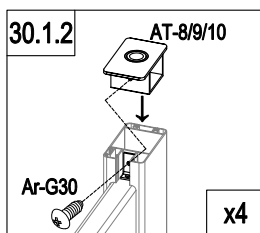
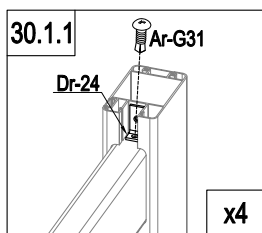
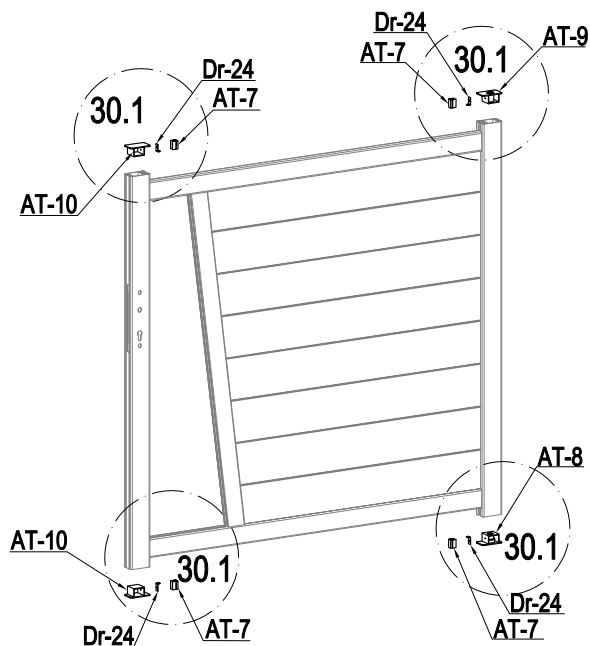

	AT-8	1
	AT-9	1
	AT-10	2
	Dr-24	4

	AT-7	4
	Ar-G30	4
	Ar-G31	4

C

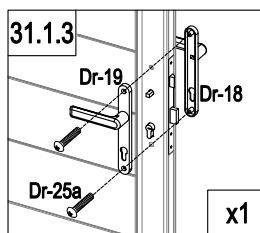
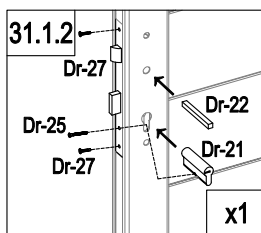
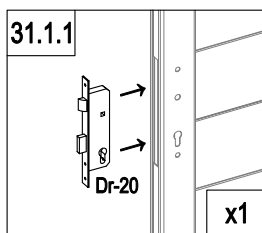
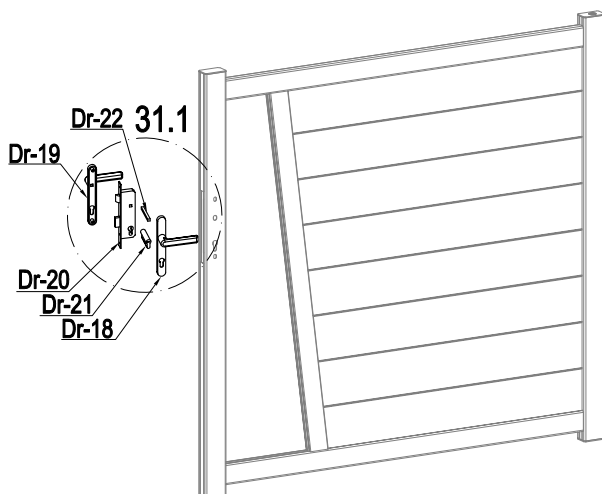



	Dr-20	1
	Dr-21	1
	Dr-22	1
	Dr-25	1

	Dr-18	1
	Dr-19	1
	Dr-25a	2
	Dr-27	2

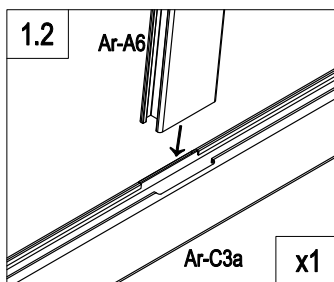
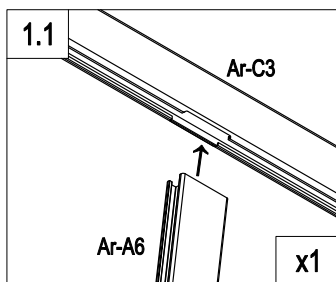
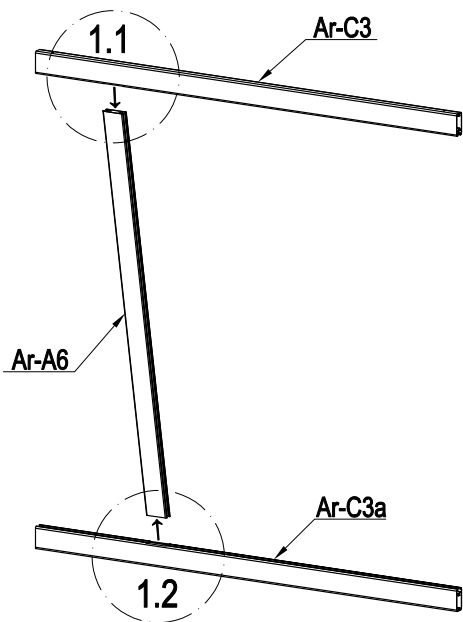
D



	Ar-A6	1
	Ar-C3	1
	Ar-C3a	1

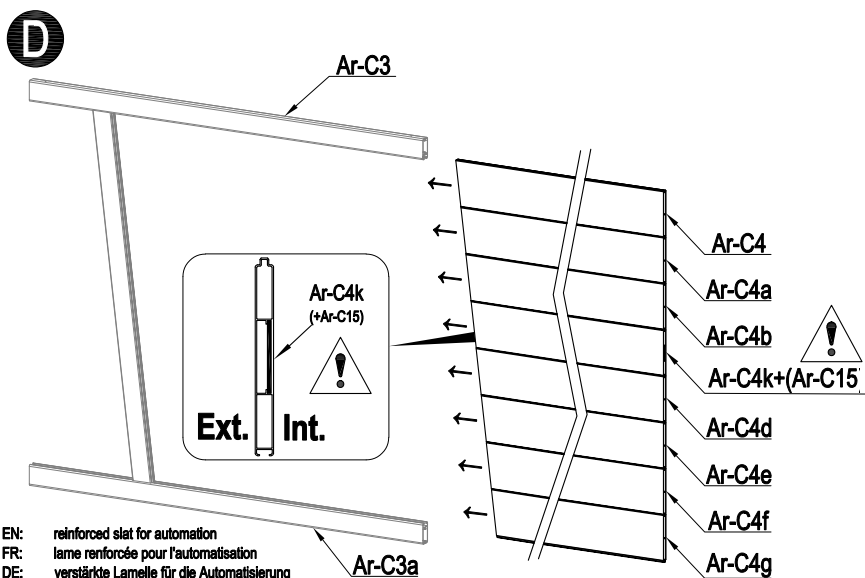

- EN: reinforced slat for automation
 FR: lame renforcée pour l'automatisation
 DE: verstärkte Lamelle für die Automatisierung
 ES: Lámina reforzada para la automatización
 PT: ripa reforçada para automatização
 IT: lamella rinforzata per l'automazione
 NL: versterkte lat voor automatisering
 PL: wzmocniona listwa do automatyzacji

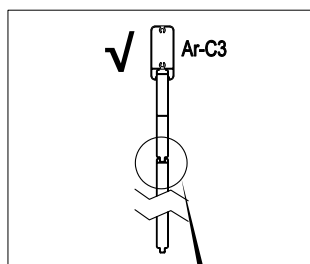
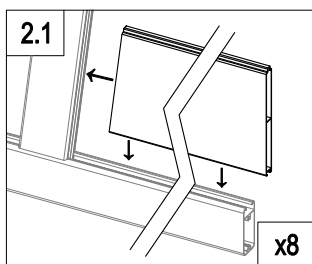



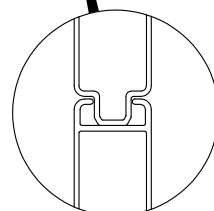

	Ar-C4	1
	Ar-C4a	1
	Ar-C4b	1
	Ar-C4d	1
	Ar-C4e	1

	Ar-C4e	1
	Ar-C4f	1
	Ar-C4g	1
Int. 	Ar-C4k (+Ar-C15)	1
Ext.		

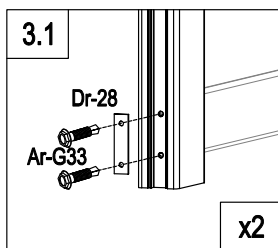
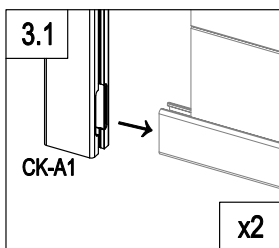
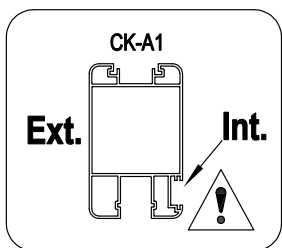
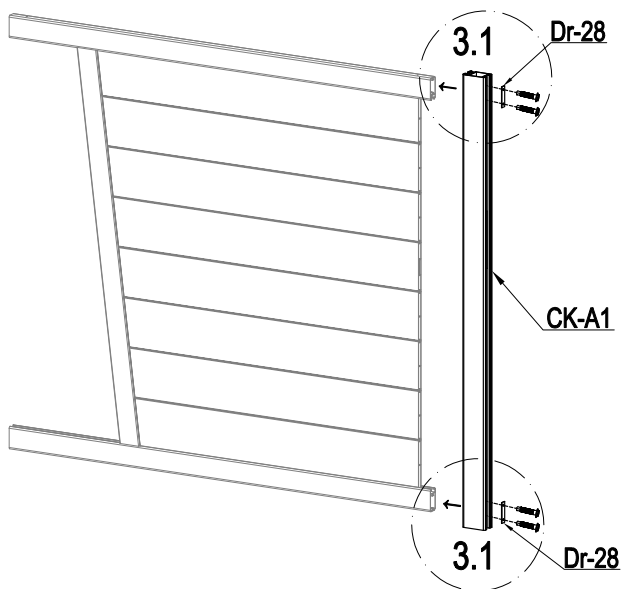



D

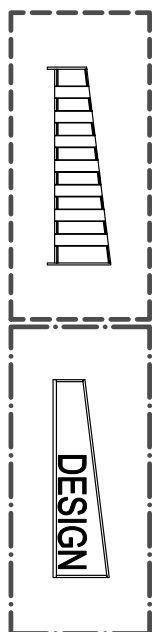
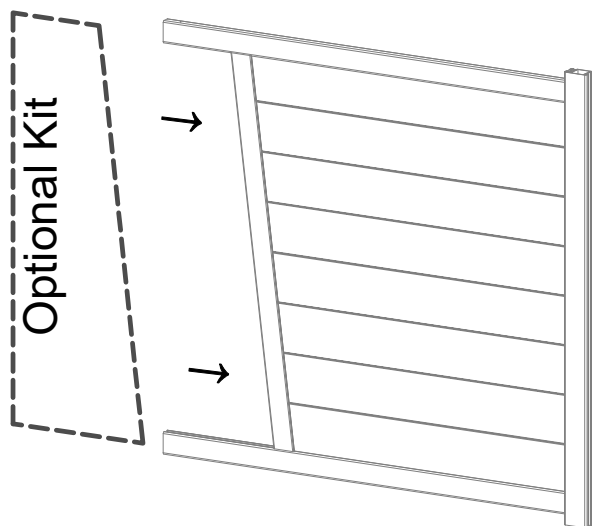

	CK-A1	1
	Dr-28	2
	Ar-G33	4

D



  P:112~116

  P:117~119

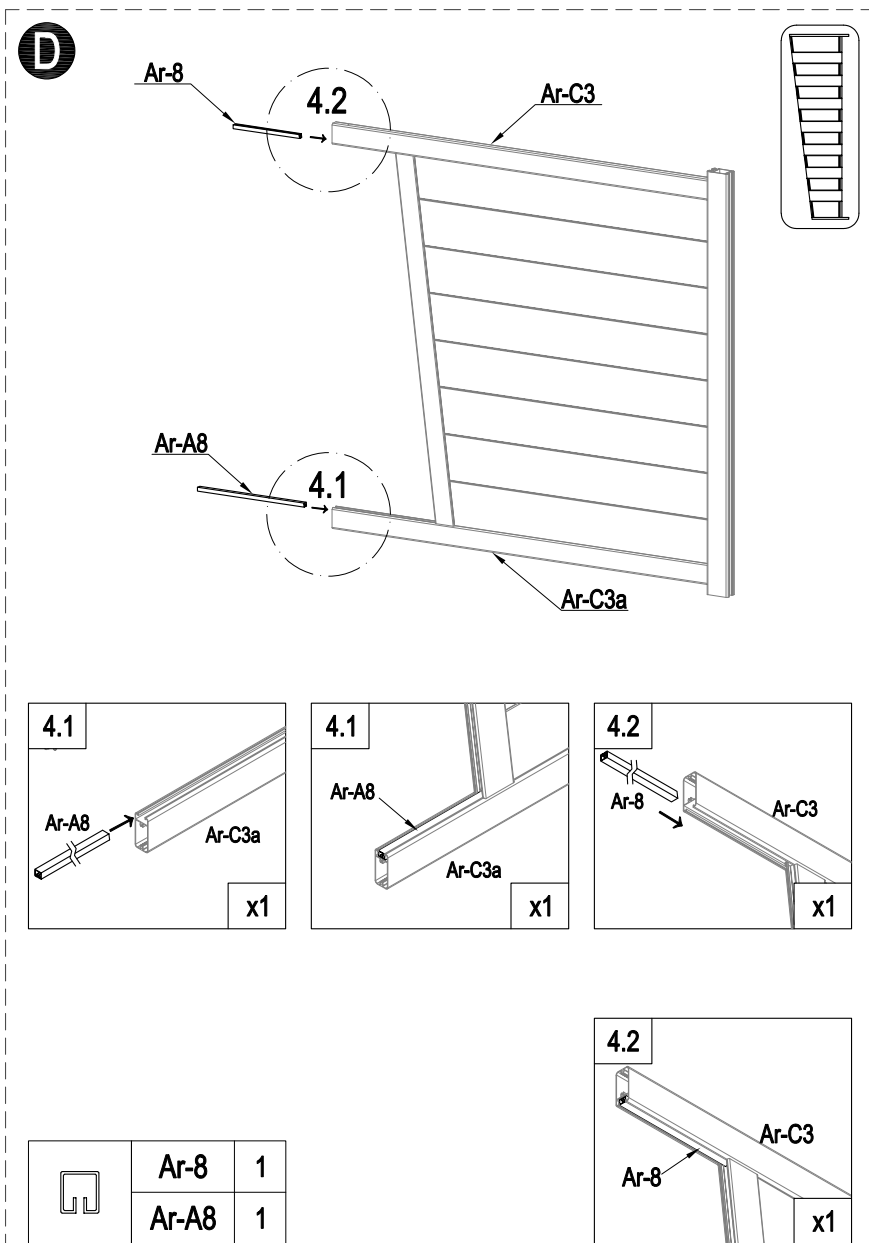

D

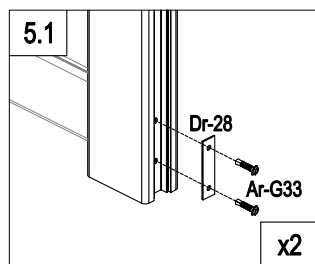
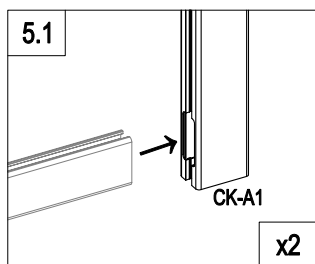
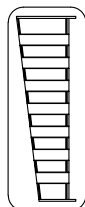
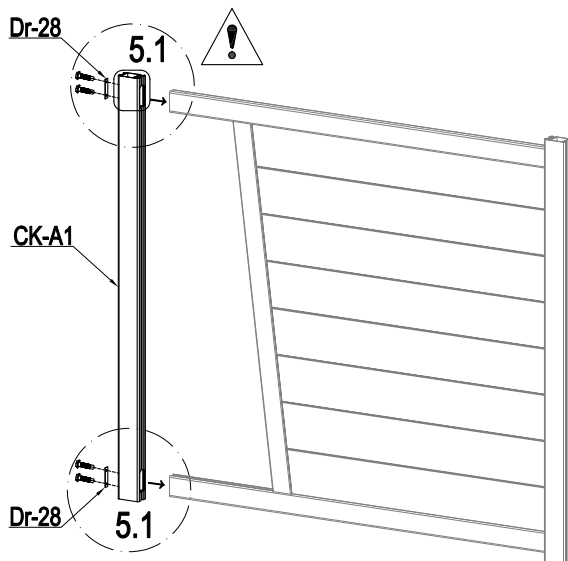

	CK-A1	1
	Dr-28	2
	Ar-G33	4

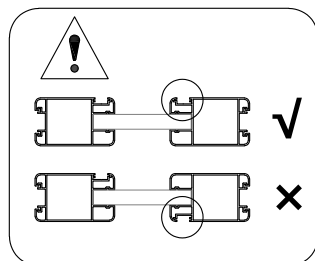

D

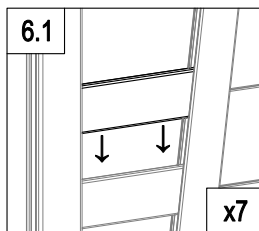
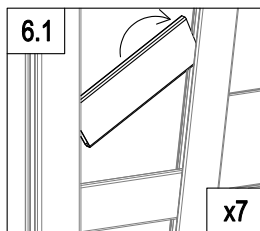
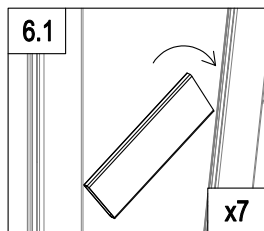
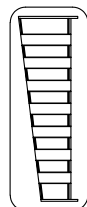
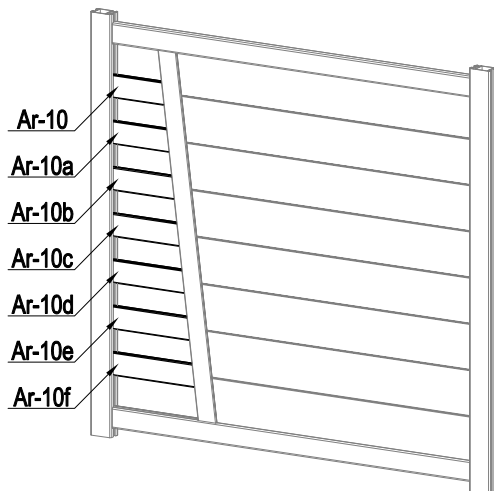



—	Ar-10	1
	Ar-10a	1
	Ar-10b	1
	Ar-10c	1

—	Ar-10d	1
	Ar-10e	1
	Ar-10f	1

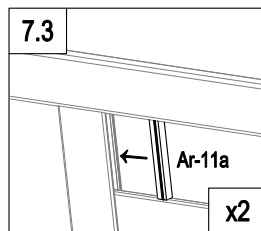
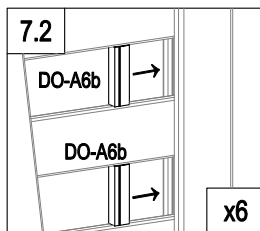
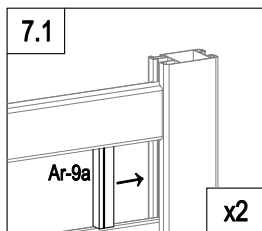
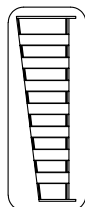
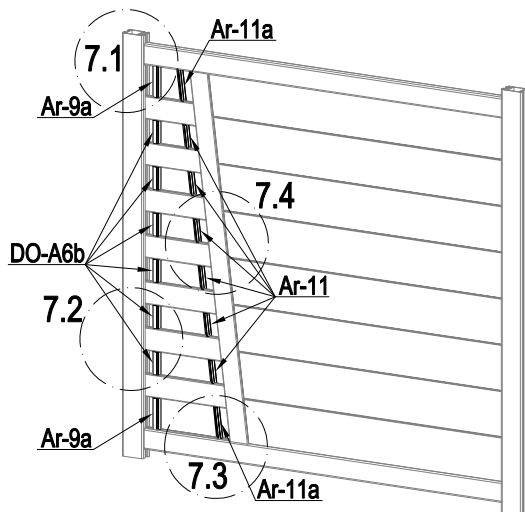
D



	DO-A6b	6
	Ar-9a	2
	Ar-11	6
	Ar-11a	2

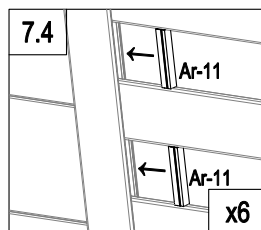

D

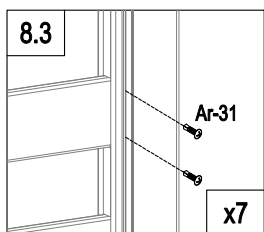
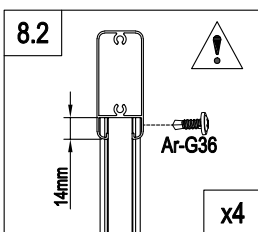
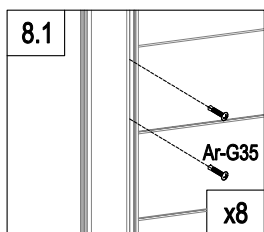
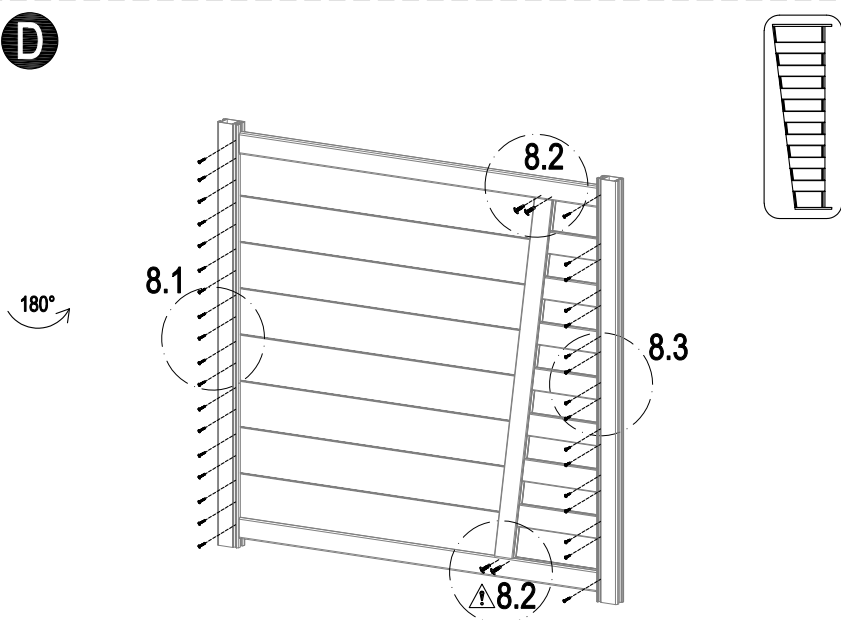

	Ar-G35	20
	Ar-G36	4
	Ar-31	14

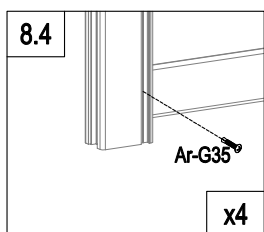

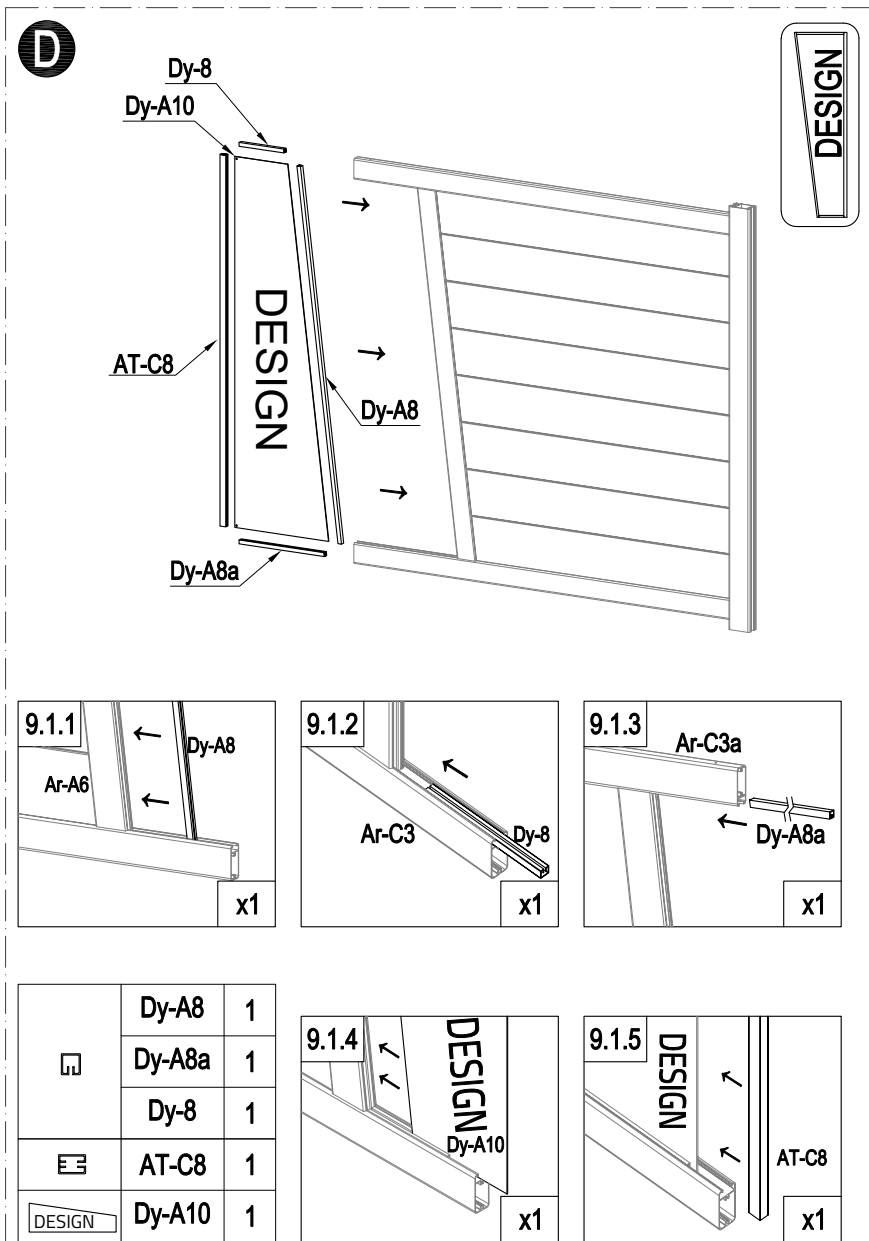



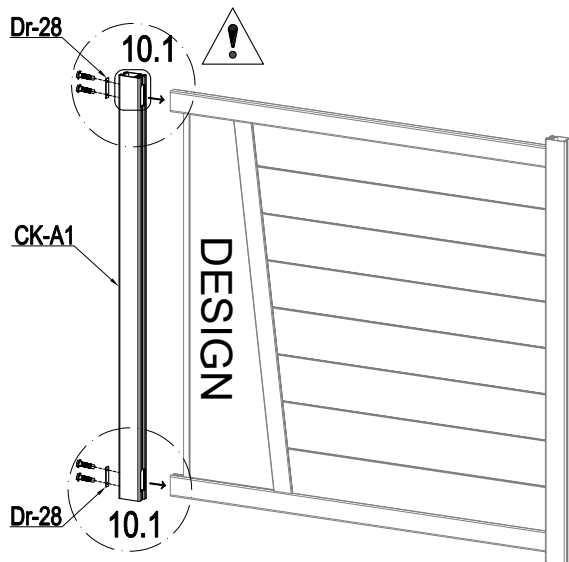

D

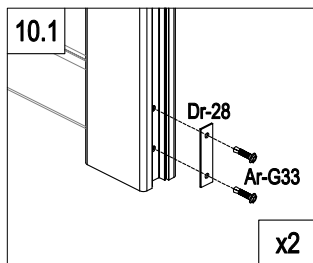
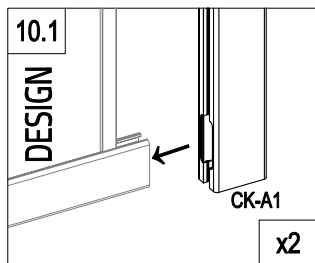

DESIGN





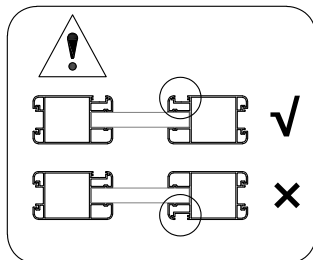

	CK-A1	1
	Dr-28	2
	Ar-G33	4

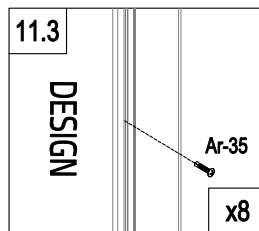
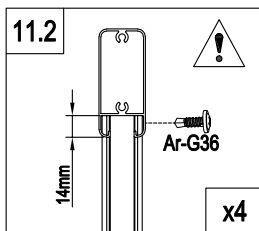
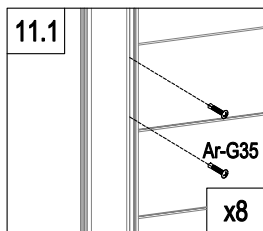
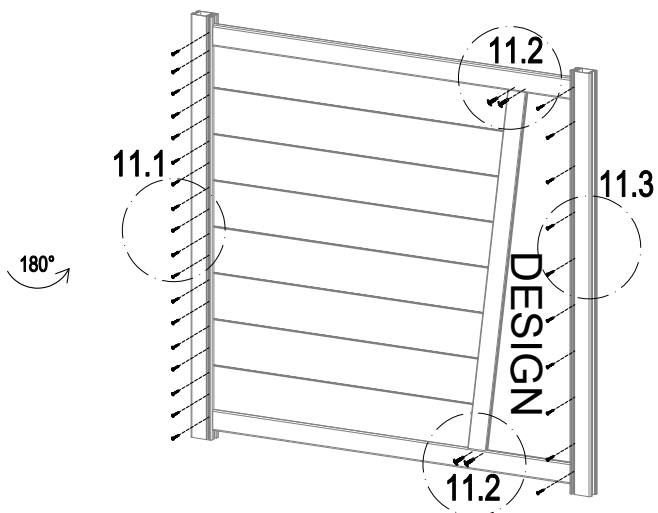

D

DESIGN



	Ar-G35	20
	Ar-G36	4
	Ar-35	8

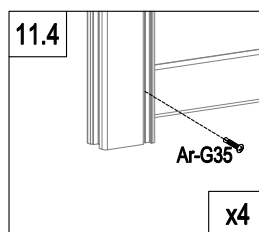

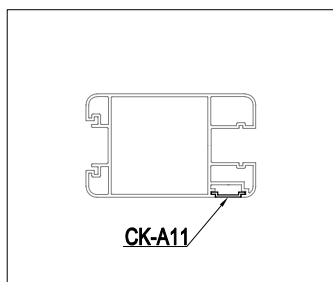
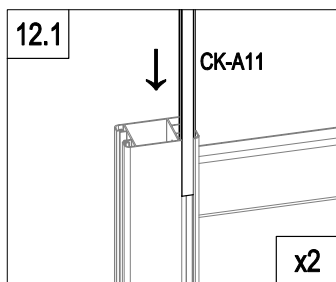
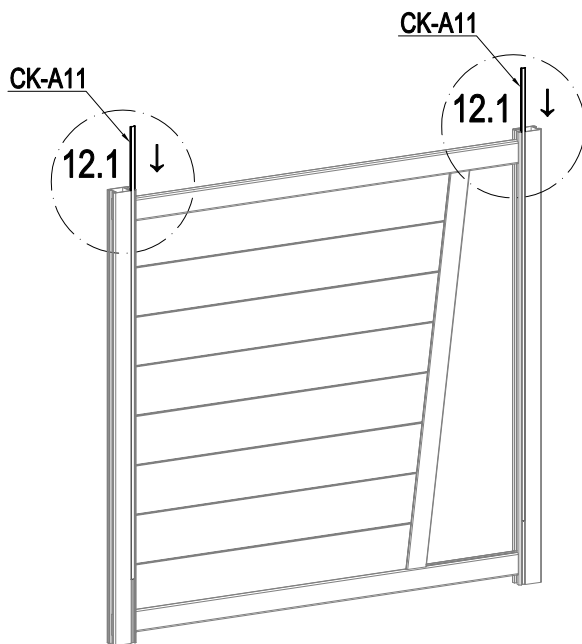

D

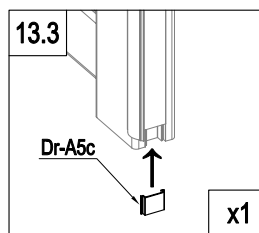
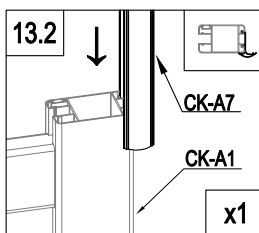
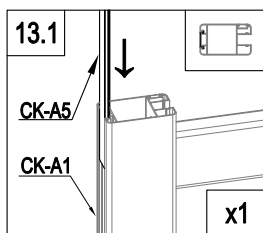
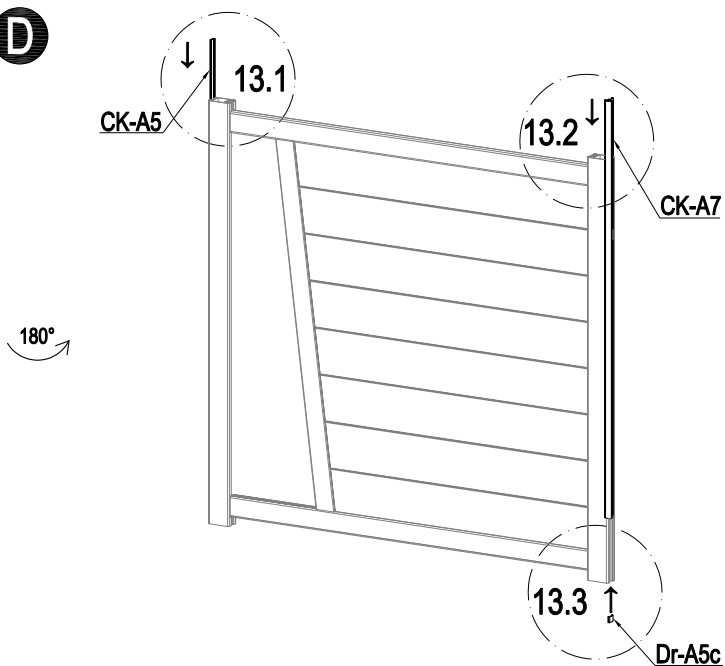

	CK-A11	2
---	--------	---

D





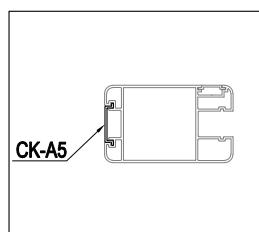

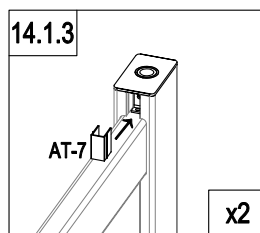
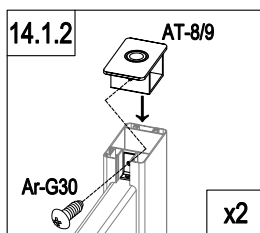
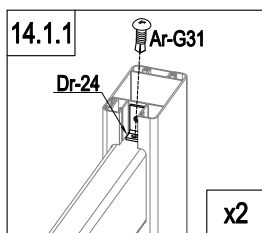
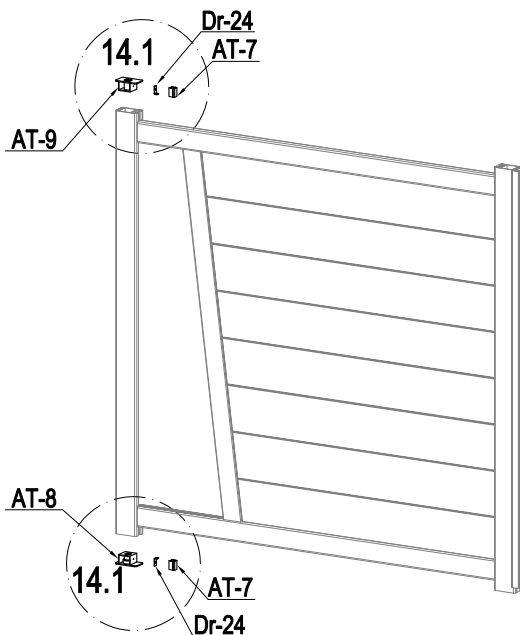

	CK-A5	1
	Dr-A5c	1
	CK-A7	1



D



	AT-8	1
	AT-9	1
	Dr-24	2

	AT-7	2
	Ar-G30	2
	Ar-G31	2

D

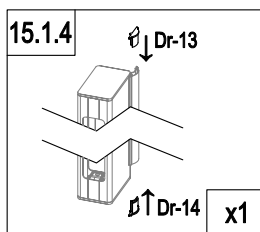
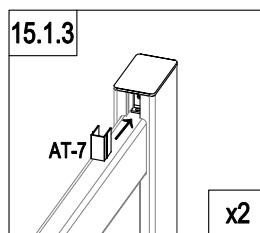
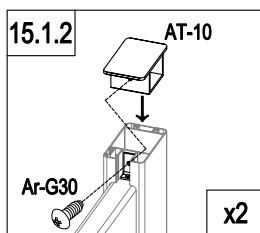
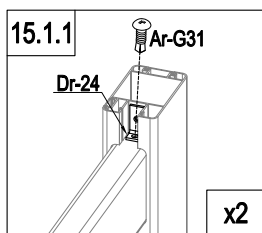
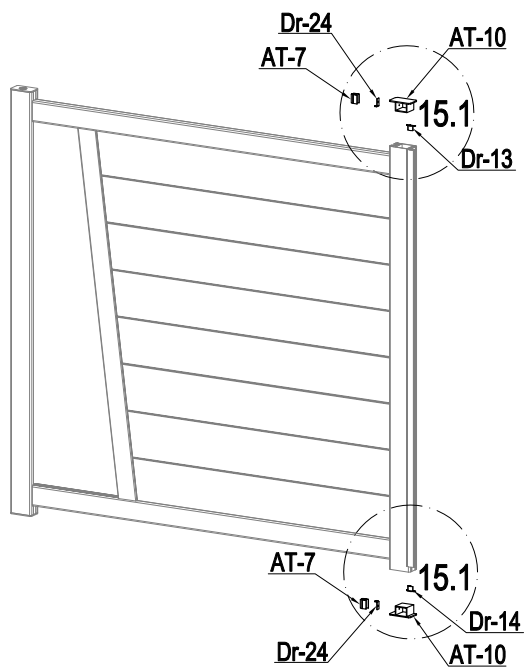

	AT-10	2
	Dr-24	2
	AT-7	2
	Dr-13	1

	Dr-14	1
	Ar-G30	2
	Ar-G31	2

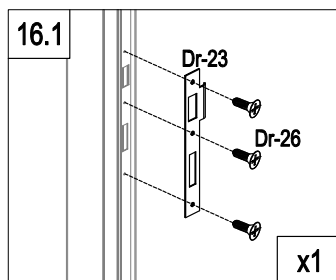
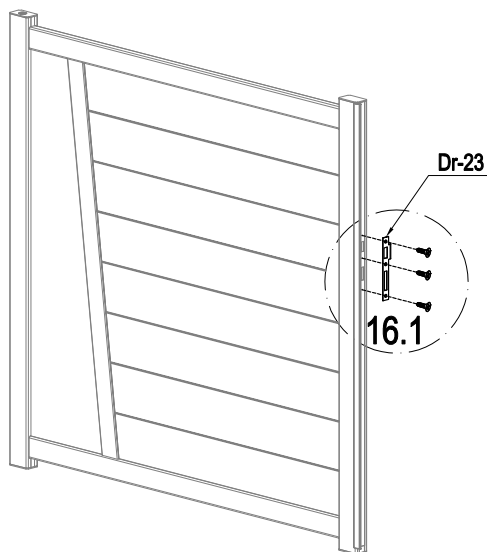

D

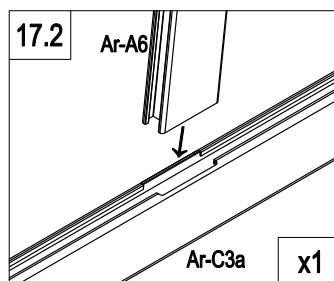
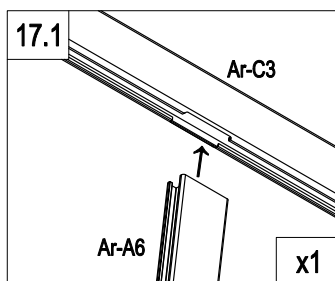
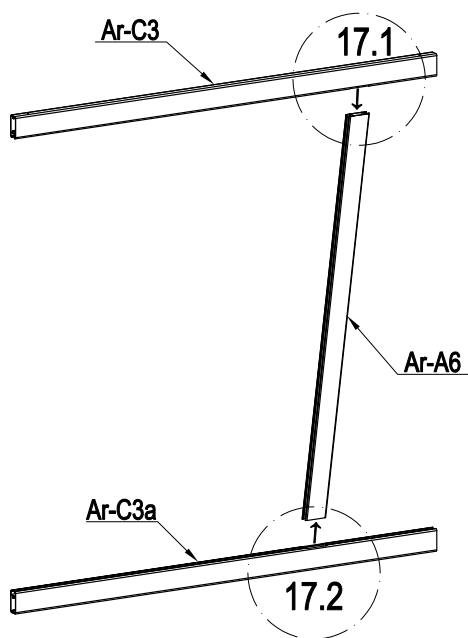

	Dr-23	1
	Dr-26	3

D



	Ar-A6	1
	Ar-C3	1
	Ar-C3a	1

D

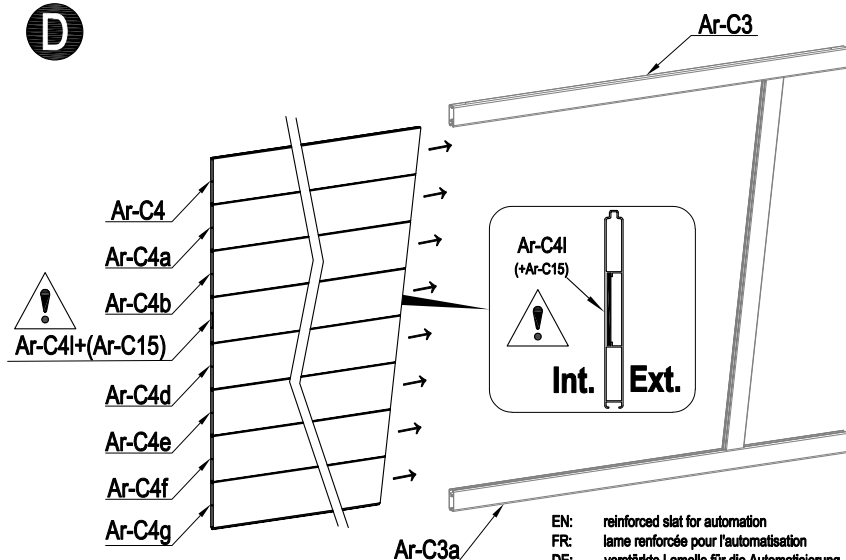

EN: reinforced slat for automation
FR: lame renforcée pour l'automatisation
DE: verstärkte Lamelle für die Automatisierung
ES: Lámina reforzada para la automatización
PT: ripa reforçada para automatização
IT: lamella rinforzata per l'automazione
NL: versterkte lat voor automatisering
PL: wzmacniona listwa do automatyzacji

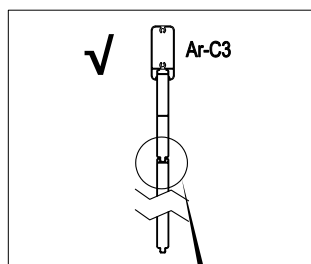
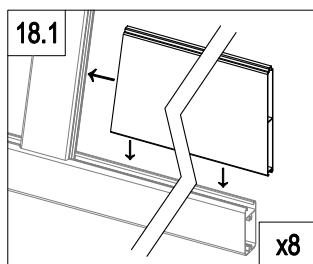



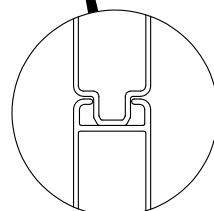

	Ar-C4	1
	Ar-C4a	1
	Ar-C4b	1
	Ar-C4d	1

	Ar-C4e	1
	Ar-C4f	1
	Ar-C4g	1
Int. Ext.	Ar-C4l (+Ar-C15)	1

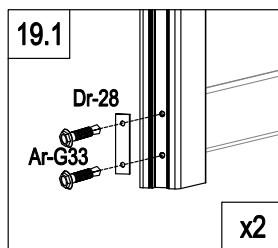
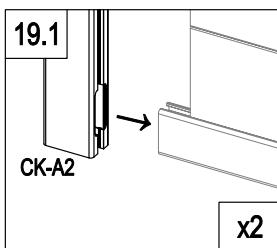
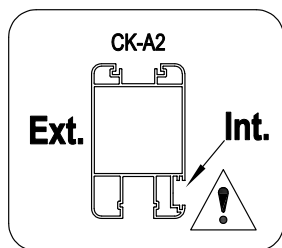
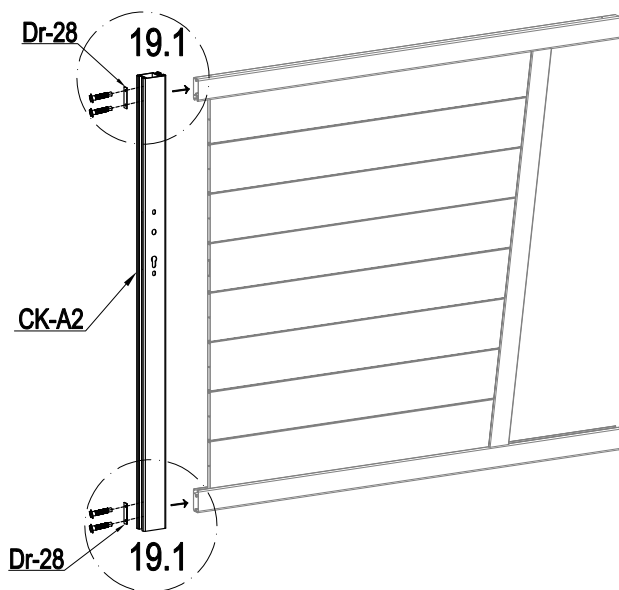



D



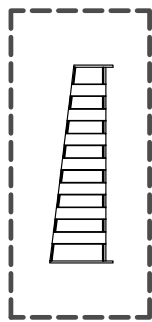
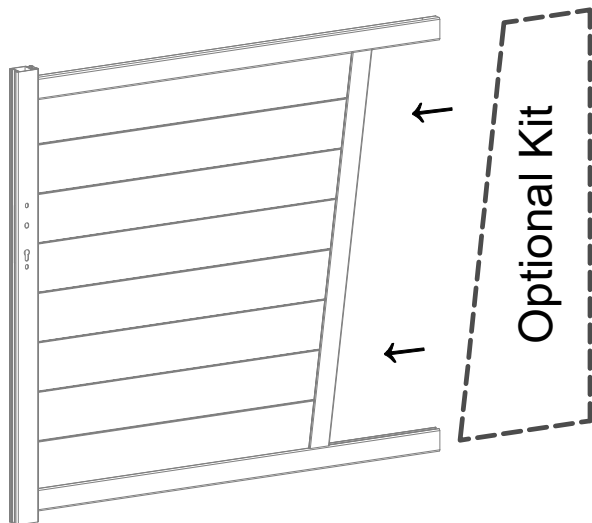

	CK-A2	1
	Dr-28	2
	Ar-G33	4

D



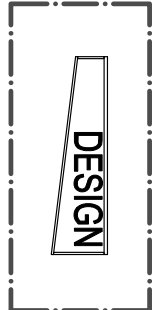

 P:129~133



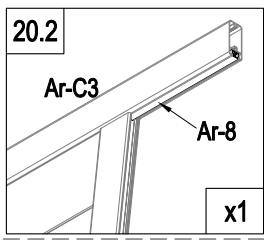
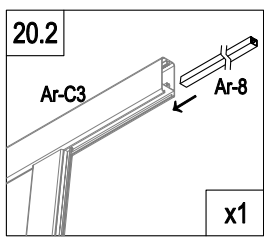
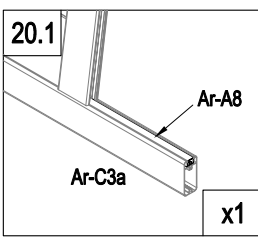
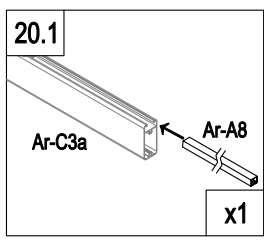
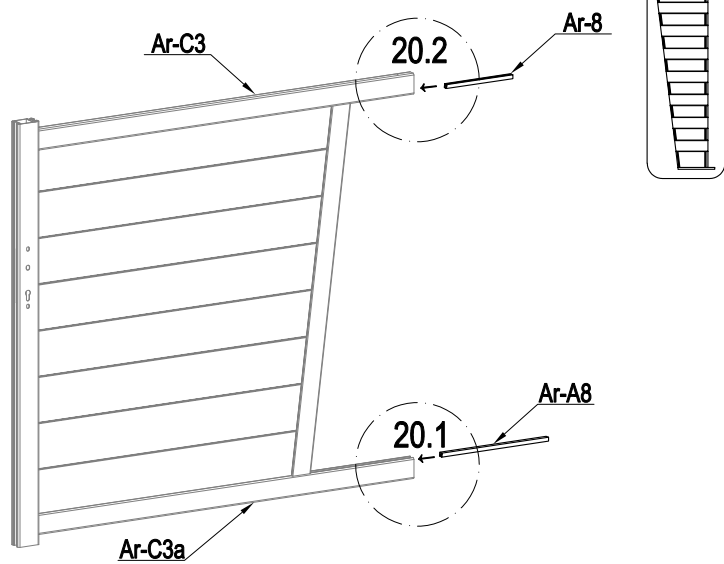

 P:134~136



D

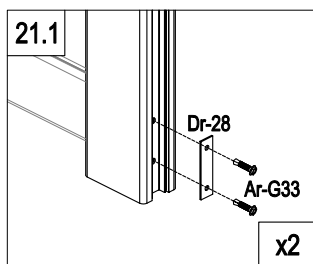
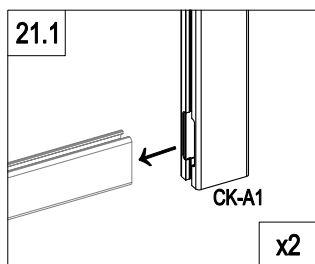
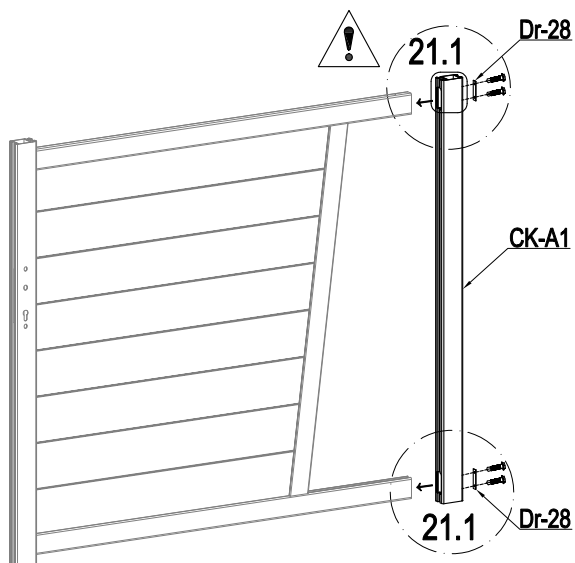

	Ar-8	1
	Ar-A8	1

D



	CK-A1	1
	Dr-28	2
	Ar-G33	4

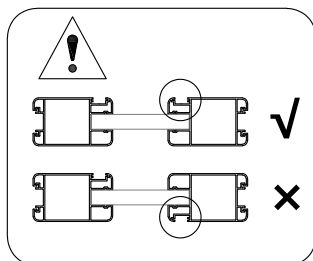

D

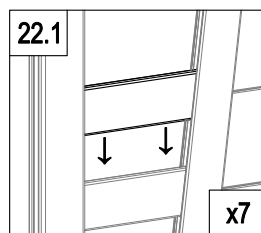
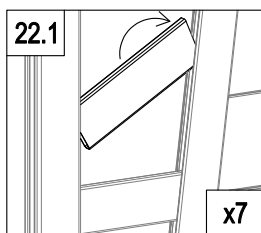
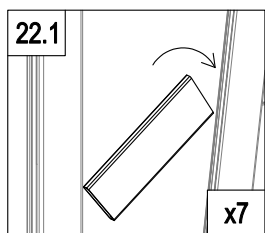
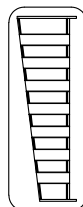
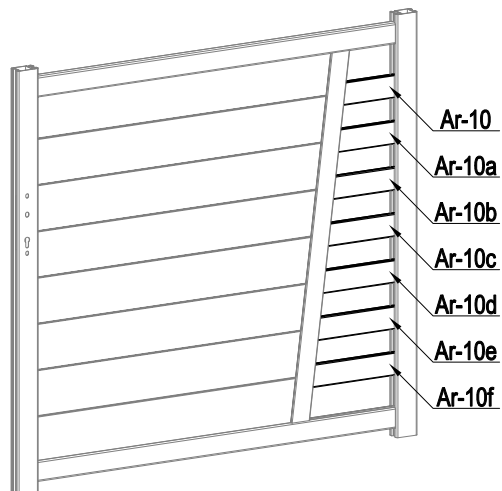

—	Ar-10	1
	Ar-10a	1
	Ar-10b	1
	Ar-10c	1

—	Ar-10d	1
	Ar-10e	1
	Ar-10f	1

D

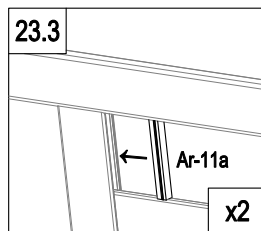
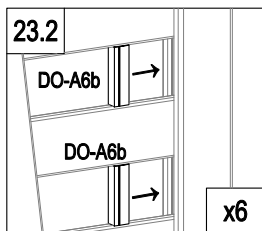
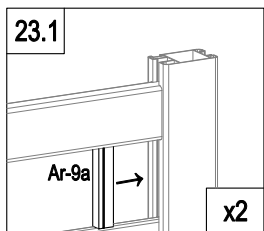
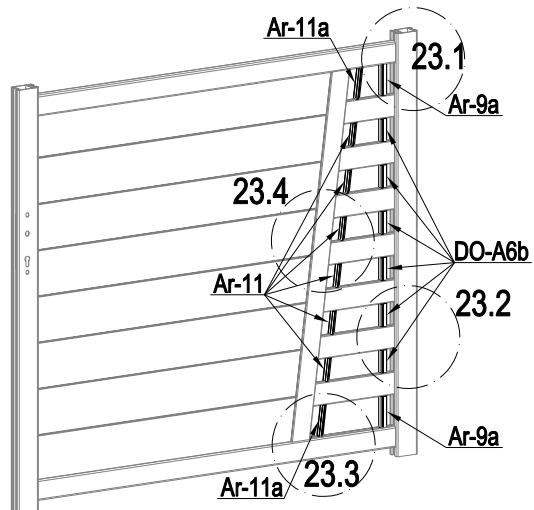

	DO-A6b	6
	Ar-9a	2
	Ar-11	6
	Ar-11a	2

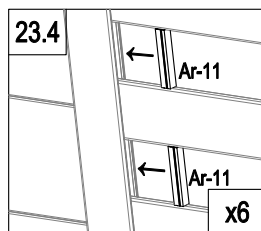

D

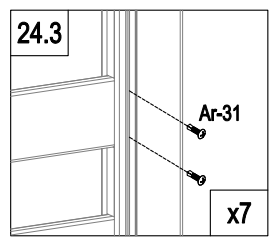
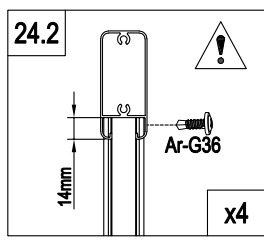
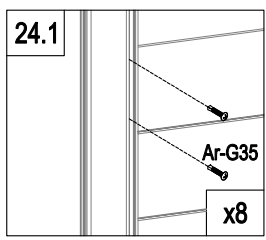
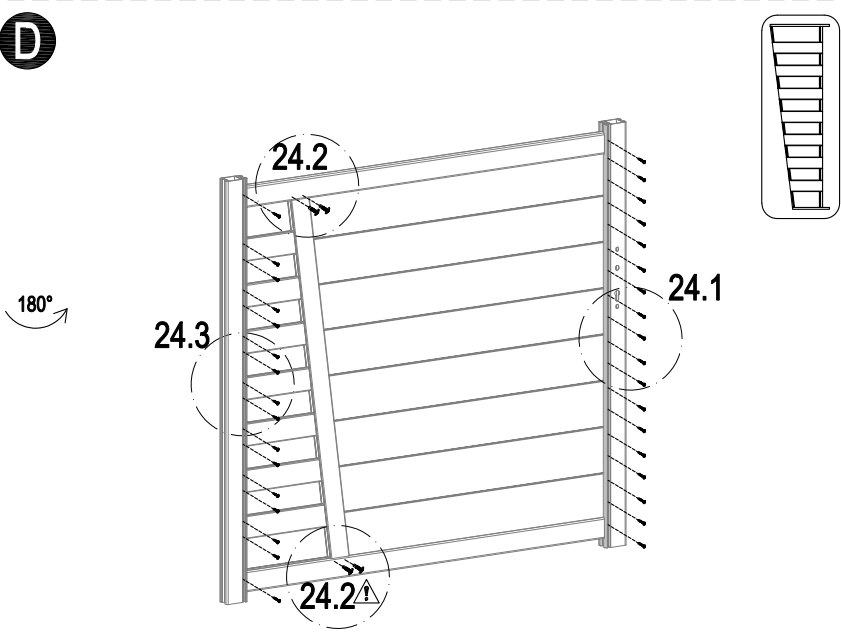

	Ar-G35	20
	Ar-G36	4
	Ar-31	14

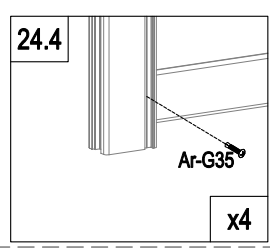

D

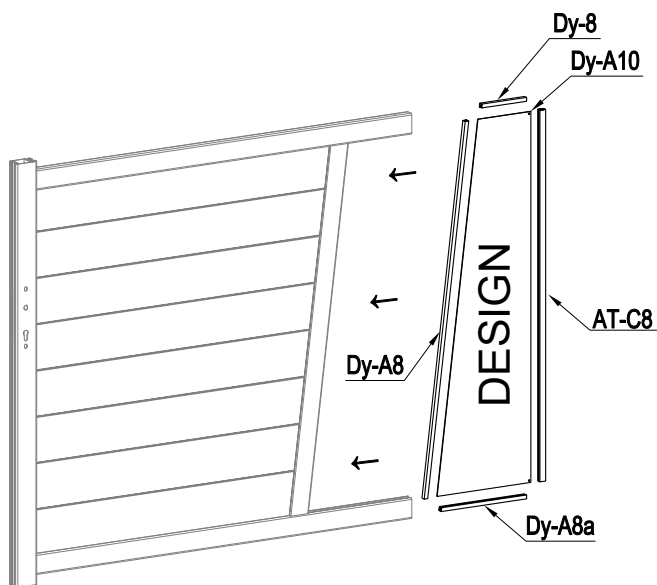

DESIGN

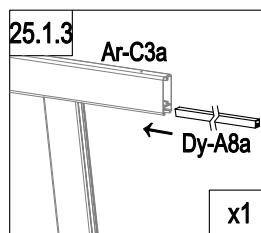
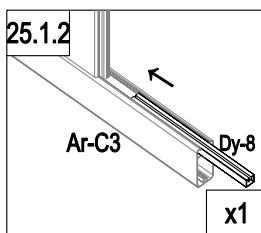
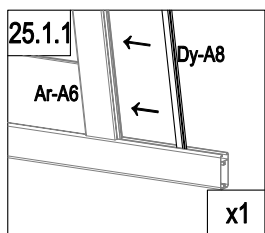

□	Dy-A8	1
	Dy-A8a	1
	Dy-8	1
▢	AT-C8	1
DESIGN	Dy-A10	1

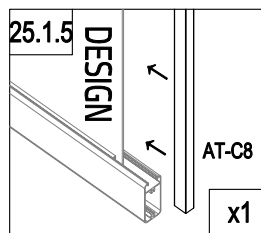
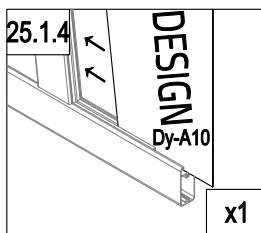

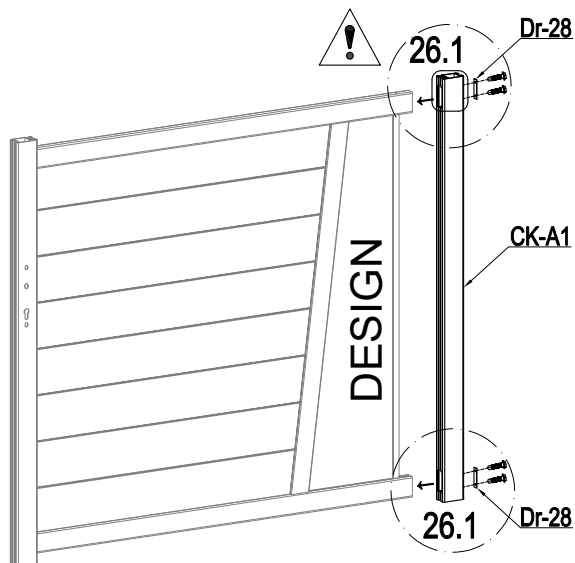

D

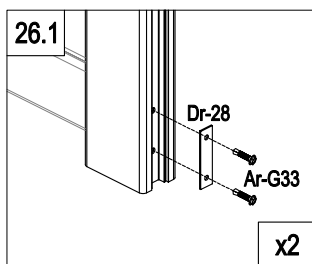
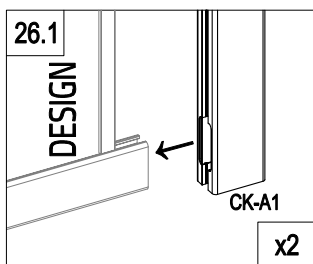

DESIGN



	CK-A1	1
	Dr-28	2
	Ar-G33	4

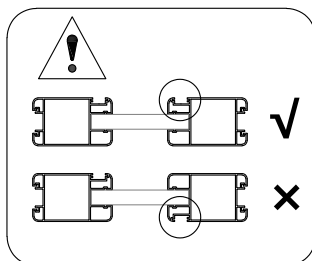

D

DESIGN

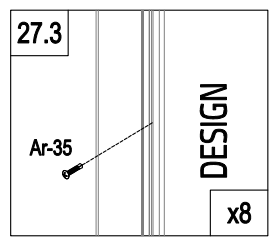
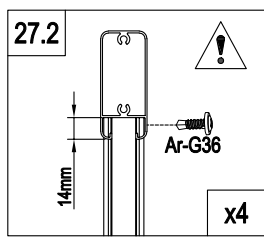
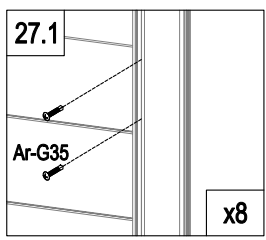
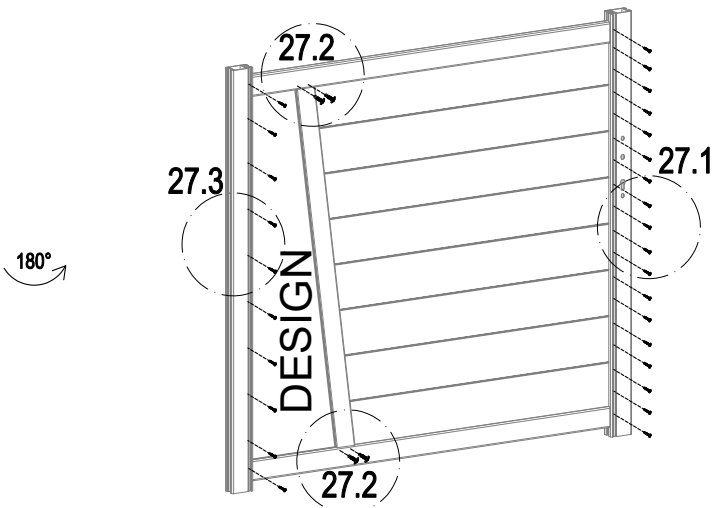

	Ar-G35	20
	Ar-G36	4
	Ar-35	8

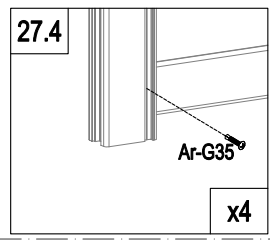

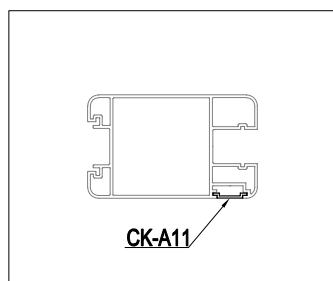
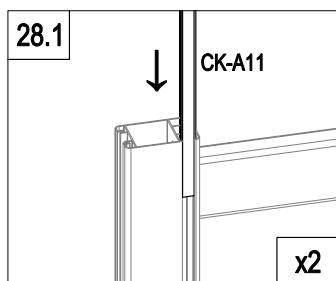
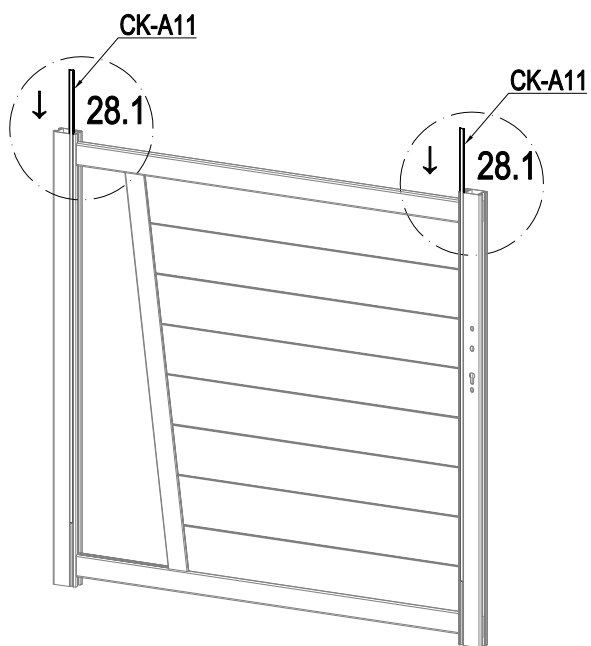

D

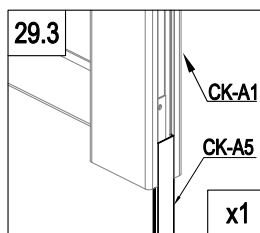
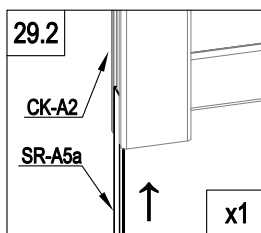
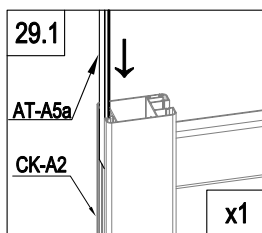
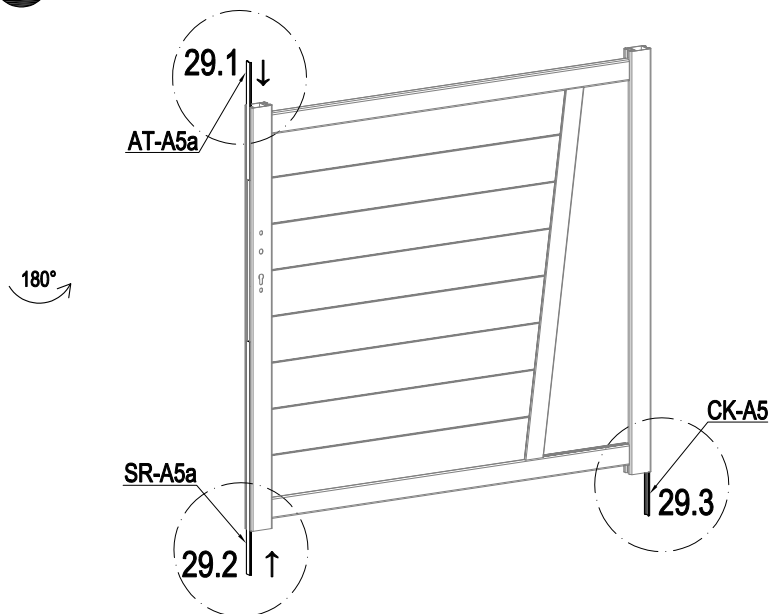

	CK-A11	2
---	--------	---

D



	CK-A5	1
	AT-A5a	1
	SR-A5a	1

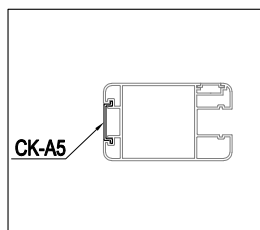

D

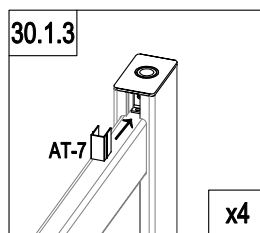
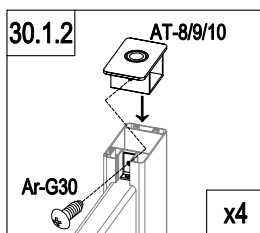
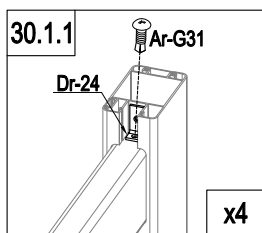
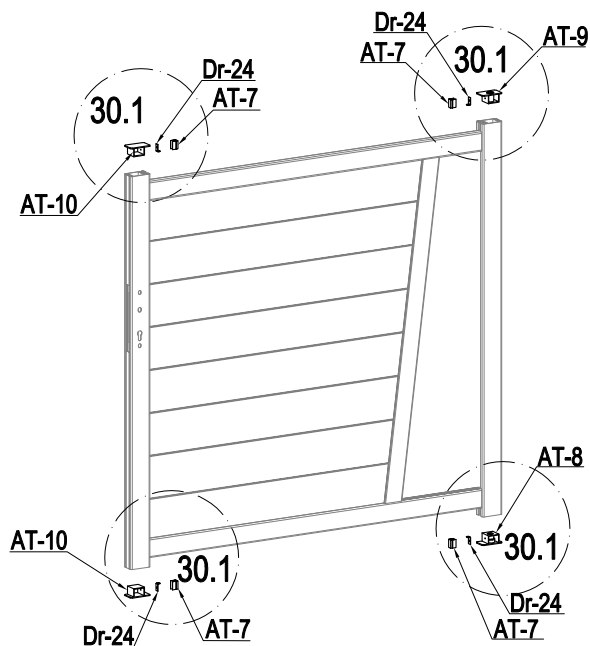

	AT-8	1
	AT-9	1
	AT-10	2
	Dr-24	4

	AT-7	4
	Ar-G30	4
	Ar-G31	4

D

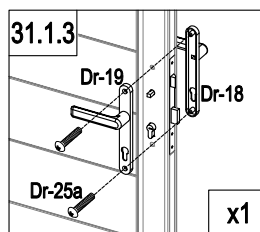
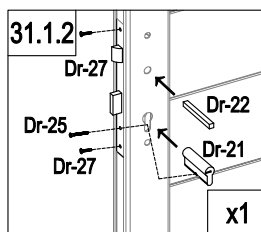
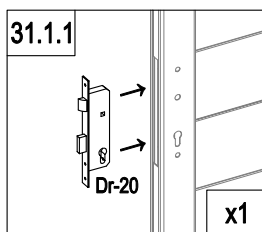
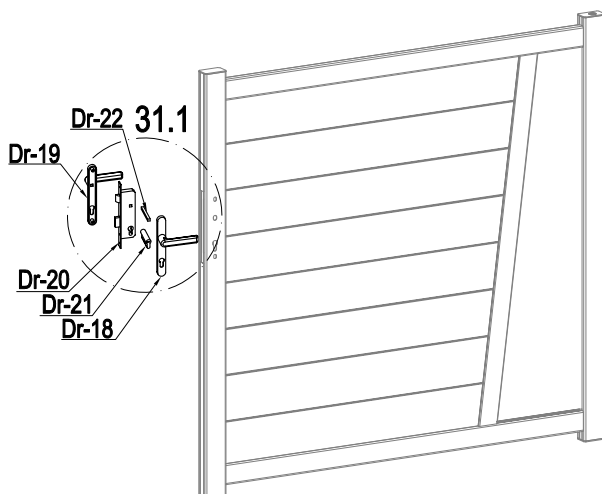

	Dr-20	1
	Dr-21	1
	Dr-22	1
	Dr-25	1

	Dr-18	1
	Dr-19	1
	Dr-25a	2
	Dr-27	2



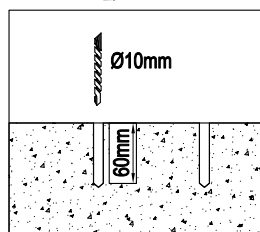
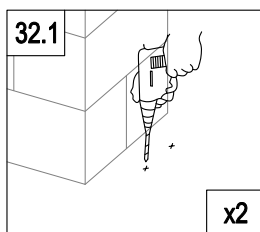
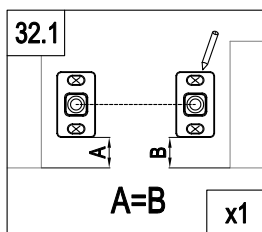
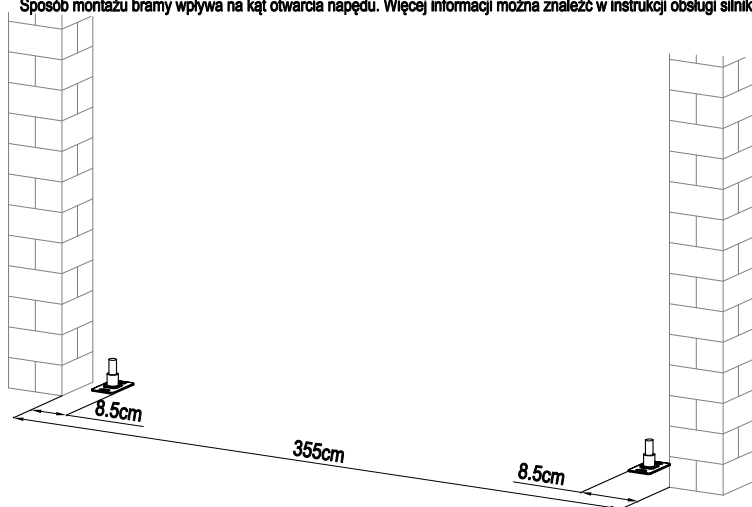

- EN:** The installation of your gate affects the opening angle of the operator. Refer to your motor manual
- FR:** L'installation de votre portail impacte l'angle d'ouverture de la motorisation. Référez vous à la notice de votre moteur
- DE:** Der Einbau Ihres Tores beeinflusst den Öffnungswinkel des Antriebs. Siehe Ihr Motorhandbuch
- ES:** La instalación de su puerta influye en el ángulo de apertura del automatismo. Consulte el manual de su motor
- PT:** A instalação do seu portão afecta o ângulo de abertura do acionamento. Consultar o manual do motor
- IT:** L'installazione del cancello influisce sull'angolo di apertura dell'operatore. Consultare il manuale del motore
- NL:** De installatie van je poort beïnvloedt de openingshoek van de aandrijving. Raadpleeg de handleiding van uw motor
- PL:** Sposób montażu bramy wpływa na kąt otwarcia napędu. Więcej informacji można znaleźć w instrukcji obsługi silnika



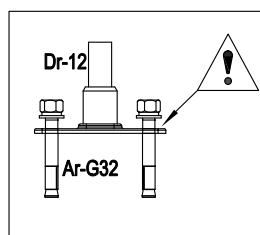
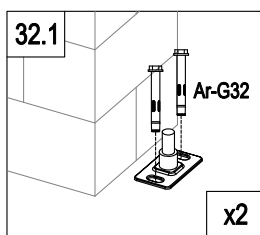

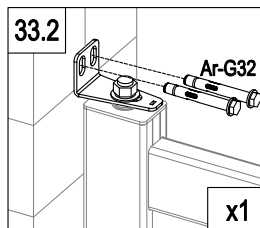
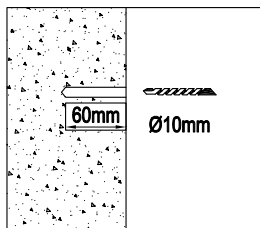
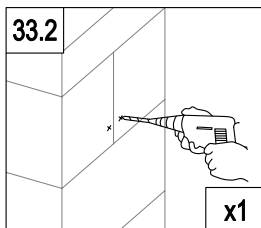
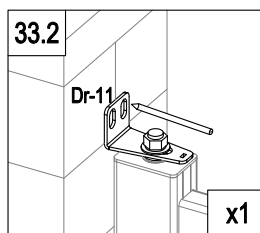
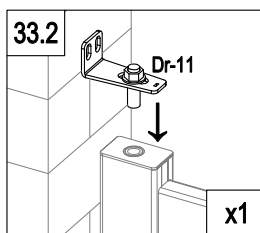
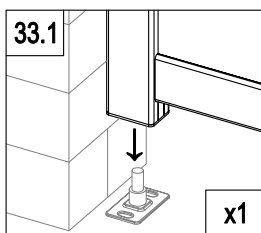
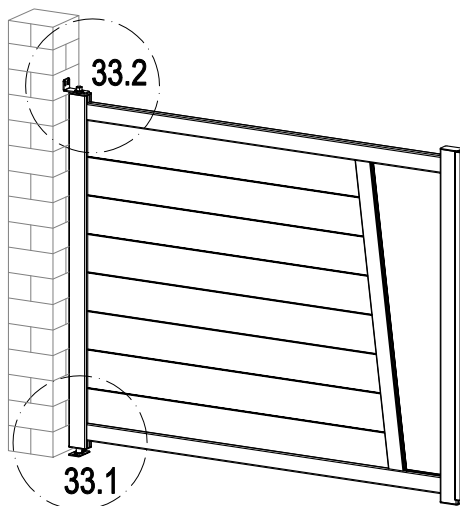
	Dr-12	2
	Ar-G32	4





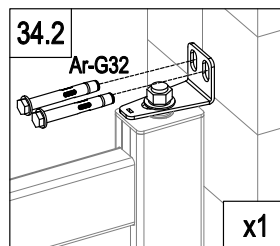
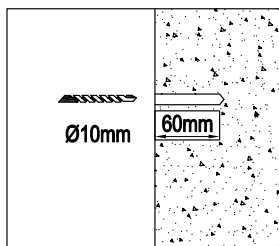
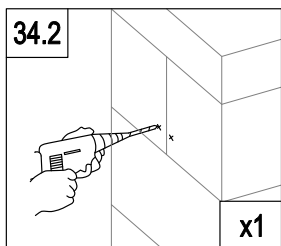
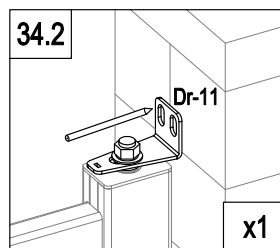
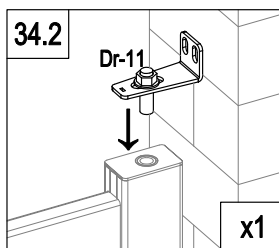
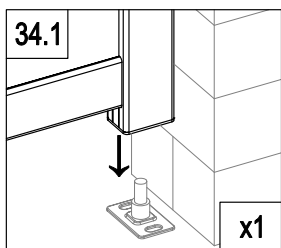
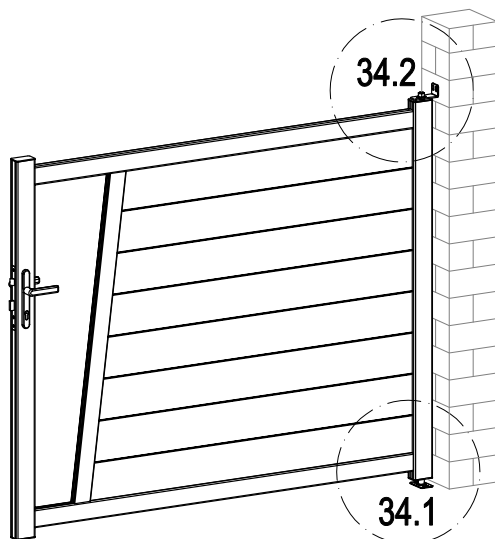

	Dr-11	1		Ar-G32	2
---	--------------	----------	---	---------------	----------



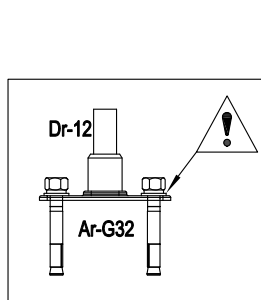
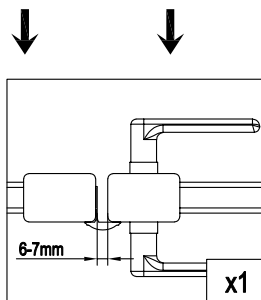
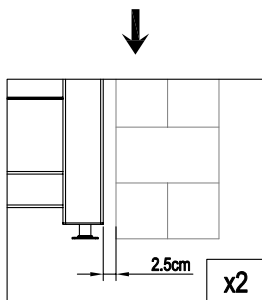
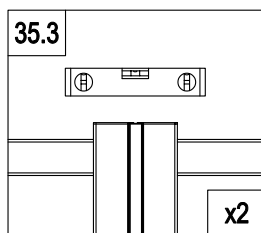
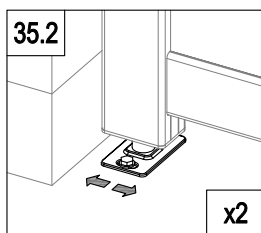
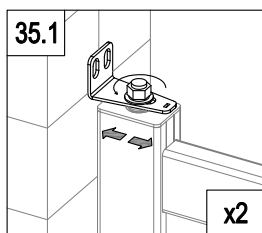
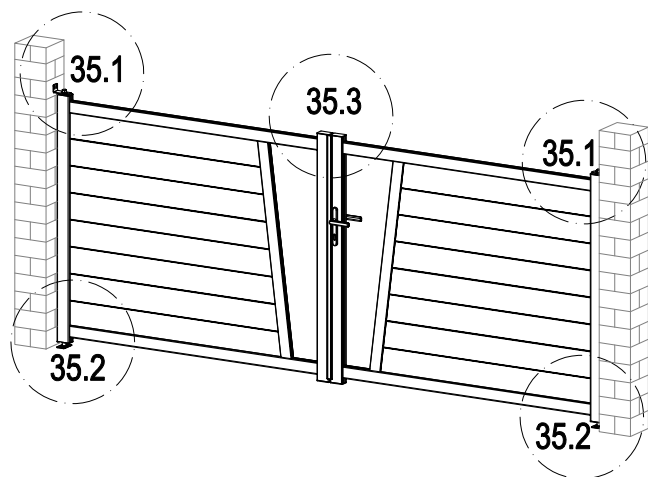

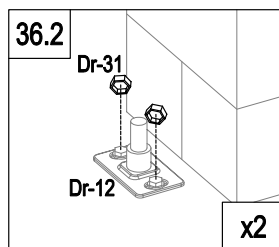
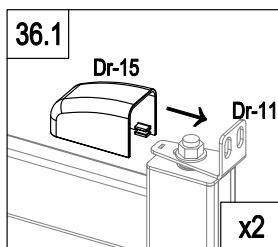
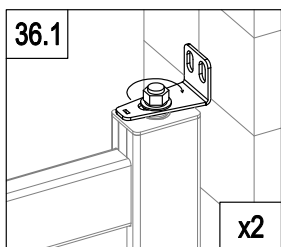
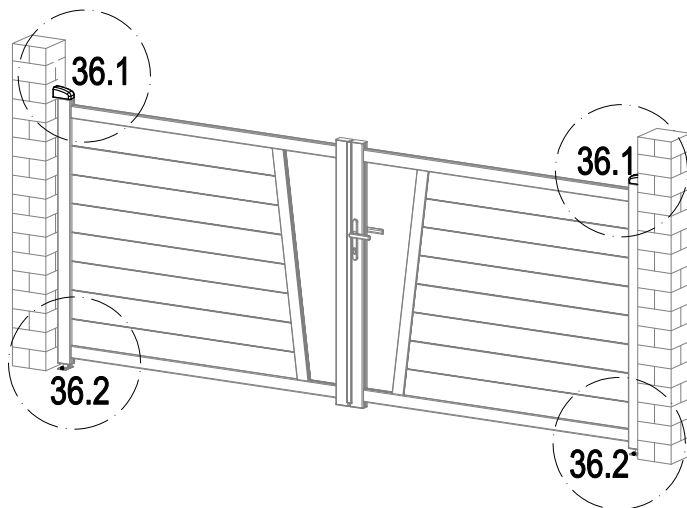

	Dr-11	1		Ar-G32	2
---	-------	---	---	--------	---



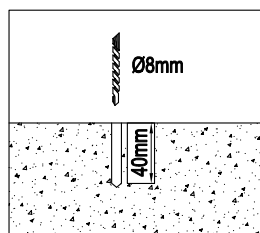
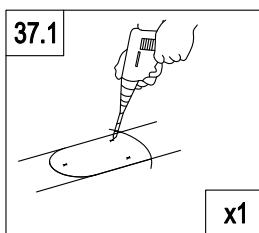
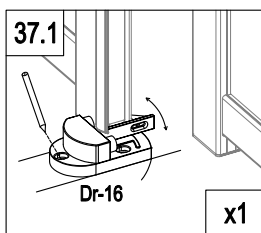
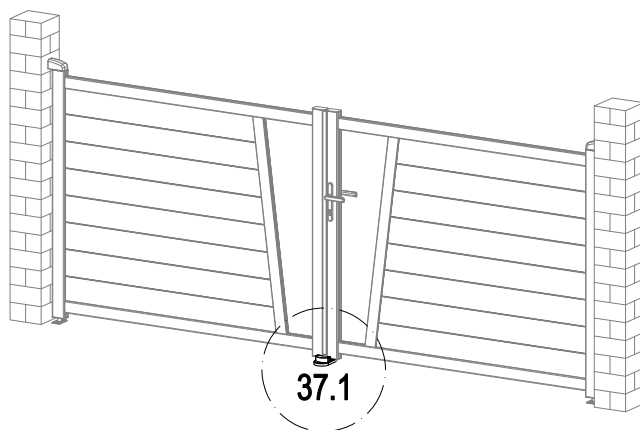



	Dr-15	2
	Dr-31	4

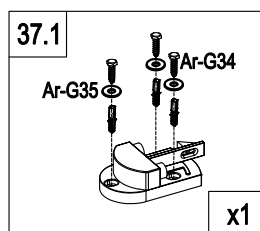

	Dr-16	1
	Ar-G34	3
	Ar-G35	3

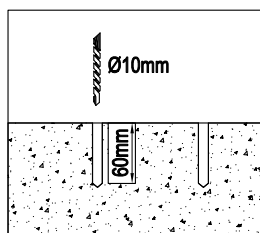
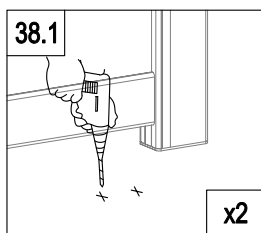
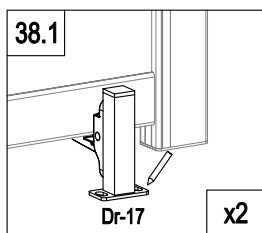
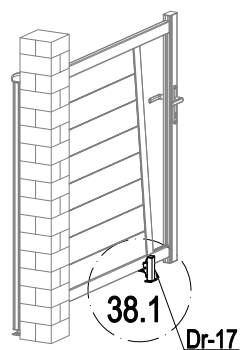
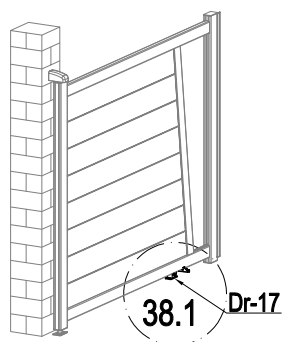



	Ar-G32	4
	Dr-17	2

