

CASANOVO

EIGER 500C160

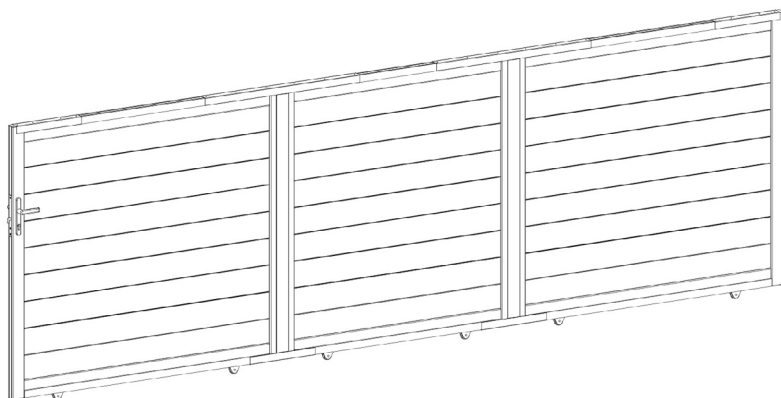

COM-000303 [x1]

COM-000304 [x1]

COM-000305 [x1]

COM-000306 [x1]

COM-000784 [x1]



INSTRUCTION MANUAL / NOTICE DE MONTAGE / MONTAGEANLEITUNG / MANUAL DE MONTAJE / MANUAL DE MONTAGEM / MANUALE DI MONTAGGIO /
MONTAGEHANDLEIDING / INSTRUKCJA MONTAŻU / KÄYTTÖOHJEET / BRUKSANVISNING / BRUGSANVISNING / INSTRUCȚIUNI DE ASAMBLARE /
NAVODILA ZA SESTAVLJANJE / NÁVOD NA MONTÁŽ / ÖSSZESZERELÉSI ÚTMUTATÓ / NÁVOD K MONTÁŽI / UPUTE ZA INSTALACIJU /
ΟΔΗΓΙΕΣ ΣΥΝΑΡΜΟΛΟΓΗΣΗΣ / SURINKIMO INSTRUKCIJOS / MONTĀŽAS INSTRUKCIJAS

Ext.

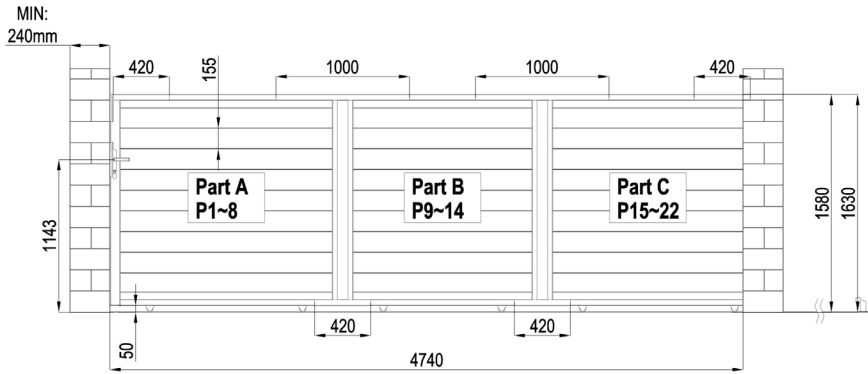

Int.

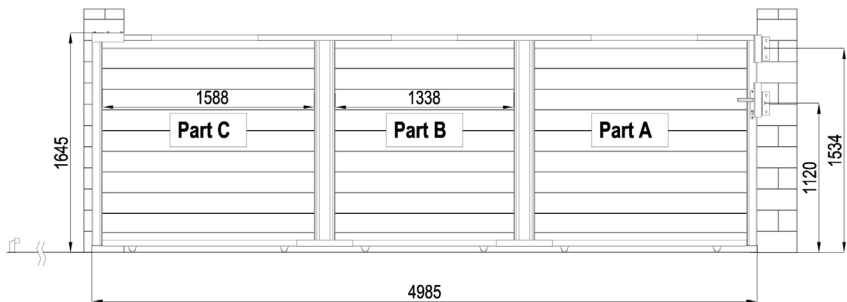

Part A.

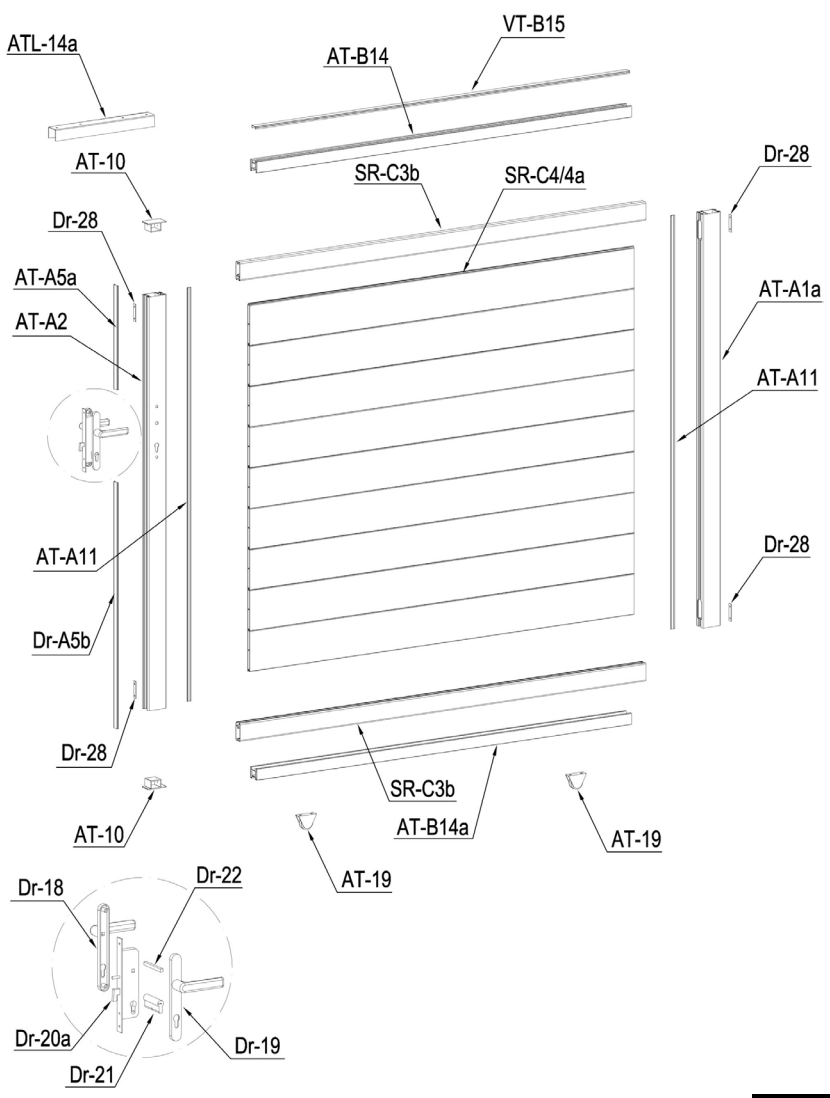

Part B.

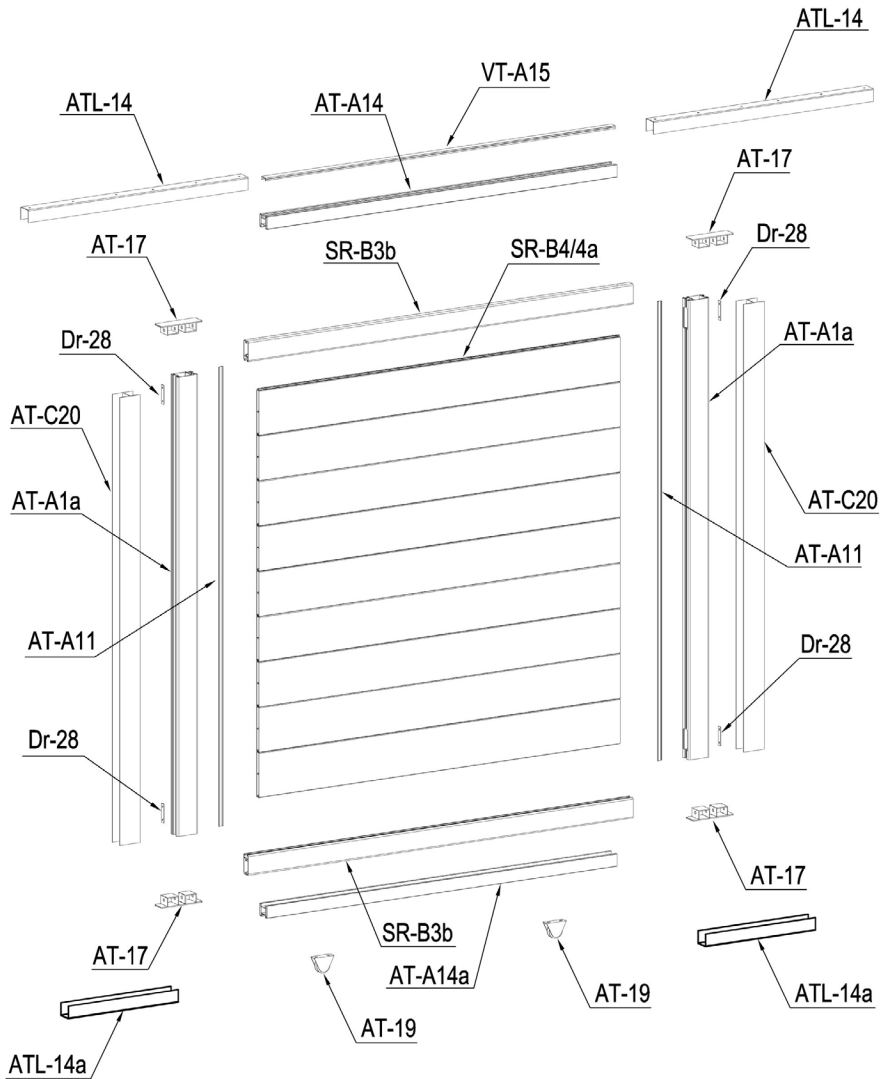



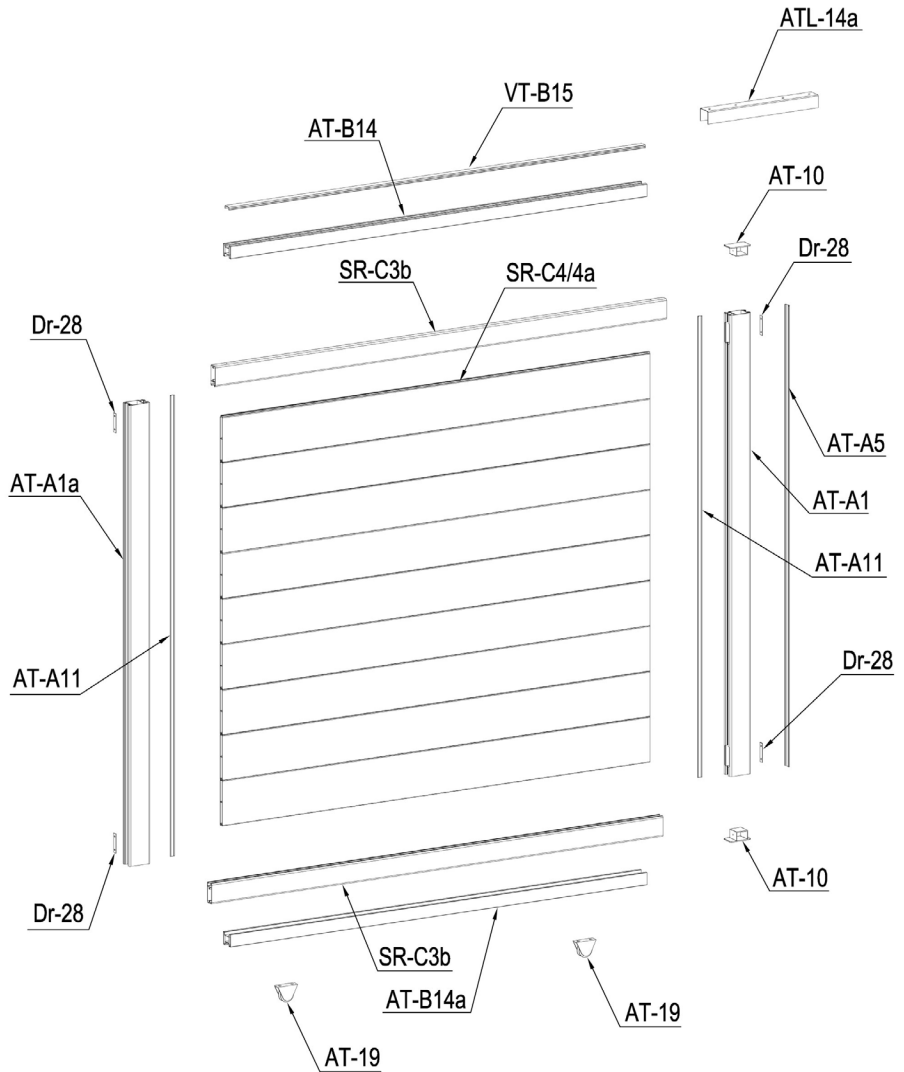

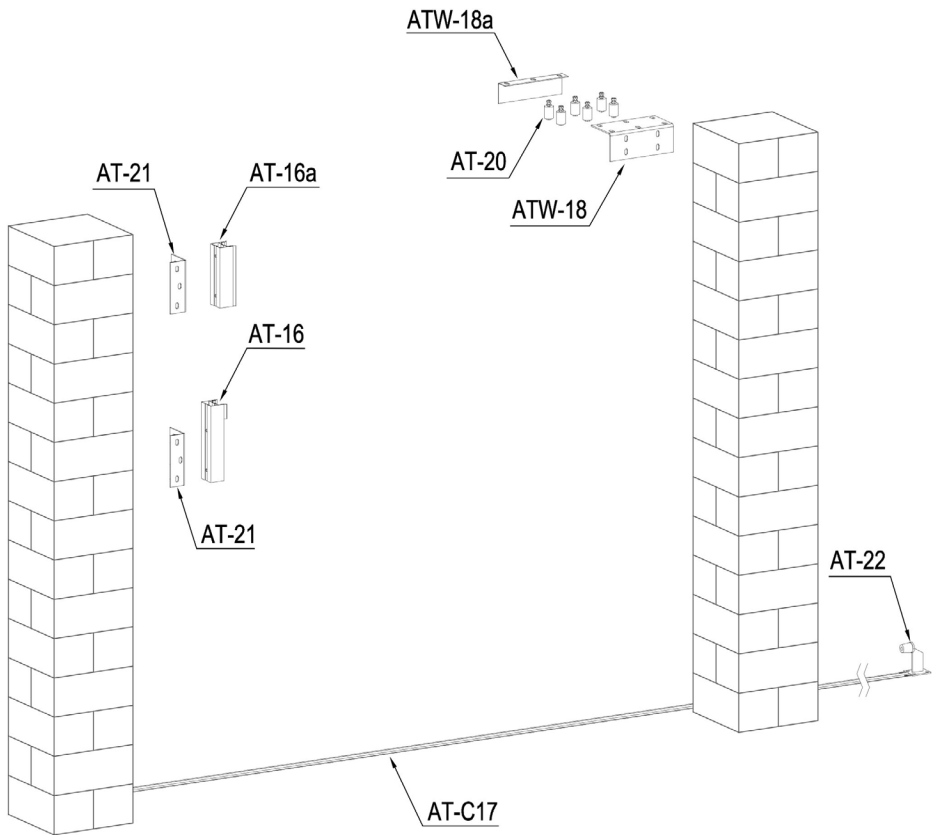

































Part C.







PART LIST

IMAGE	NO.	L.(mm)	QTY	IMAGE	NO.	L.(mm)	QTY
	AT-A1a	1573	4		AT-10		4
	AT-A1	1573	1		ATW-18		1
	AT-A2	1573	1		ATW-18a		1
	SR-B3b	1471	2		AT-19		6
	SR-C3b	1721	4		AT-20		6
	SR-B4	1380	8		AT-21		2
	SR-C4	1630	16		AT-22		1
	SR-B4a	1380	1		Dr-18		1
	SR-C4a	1630	2		Dr-19		1
	AT-A5	1573	1		Dr-20a		1
	AT-A5a	395.5	1		Dr-21		1
	Dr-A5b	937	1		Dr-22		1
	AT-A11	1573	6		Dr-25		1
	AT-C20	1493	2		Dr-25a		2
	AT-A14	1338	1		Dr-27		2
	AT-A14a	1338	1		Dr-28		12
	AT-B14	1588	2		ATW-22J		10
	AT-B14a	1588	2		CKW-E30		4
	VT-A15	1337	1		CKW-E31		14
	VT-B15	1587	2		CKW-E32		46
	AT-16	260	1		CKW-E33		4
	AT-16a	205	1		CKW-E34		138
	AT-C17	1580	6		CKW-E36		4
	ATL-14	1000	2		CKW-E37		12
	ATL-14a	420	4		CKW-E38		60
	AT-17		4				

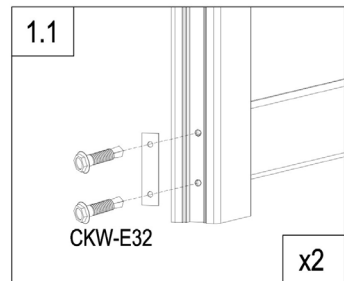
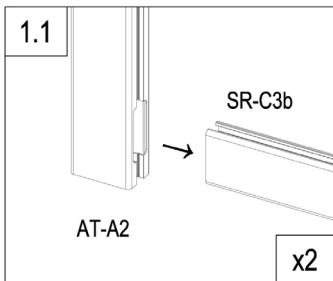
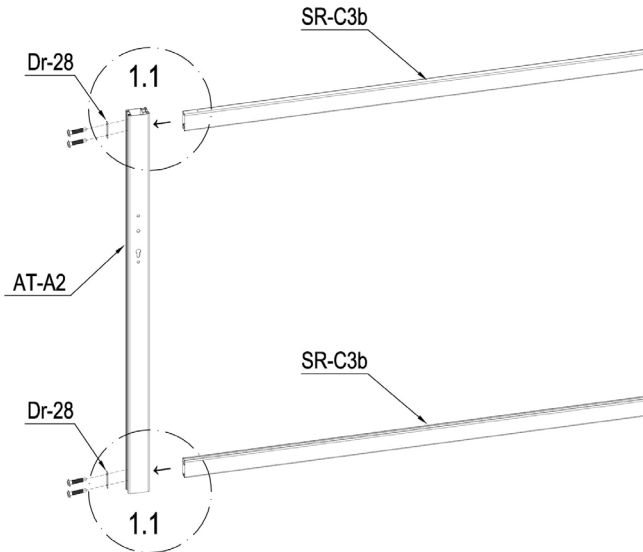
Part A.



	AT-A2	1
	SR-C3b	2
	Dr-28	2
	CKW-E32	4

Part A.

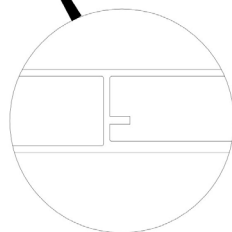
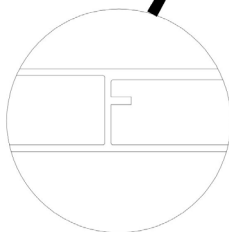
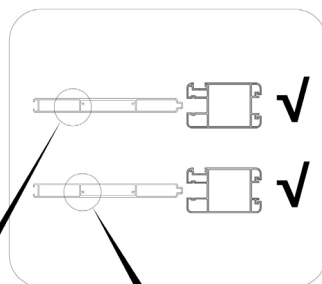
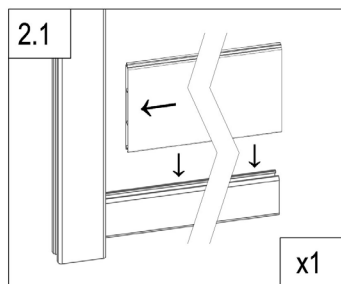
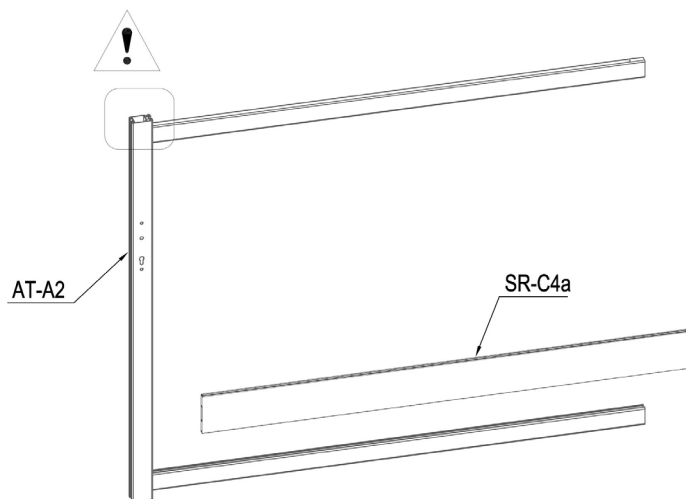

	SR-C4a	1
-------------------------------------------------------------------------------------	--------	---

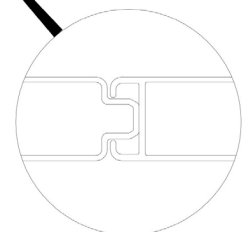
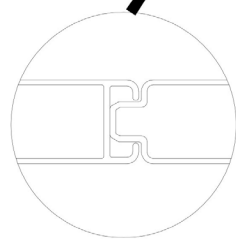
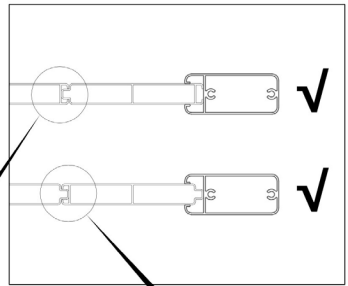
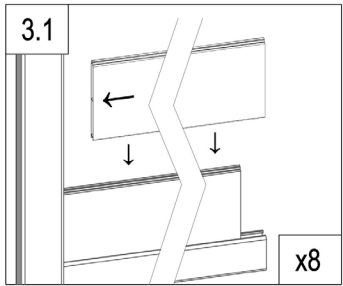
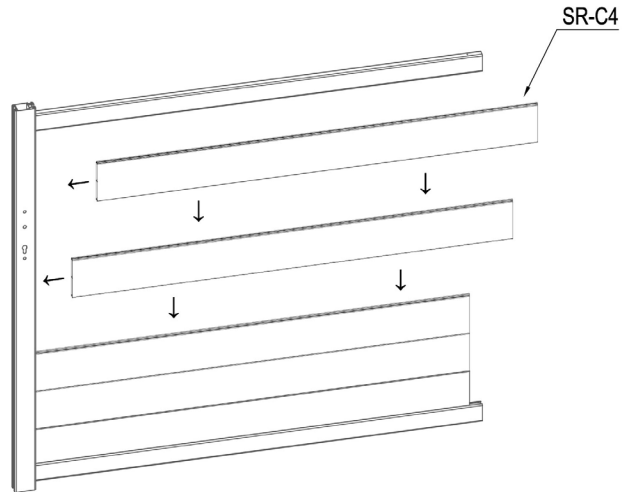

Part A.

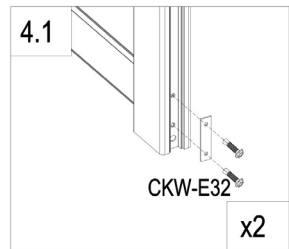
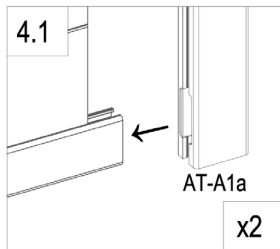
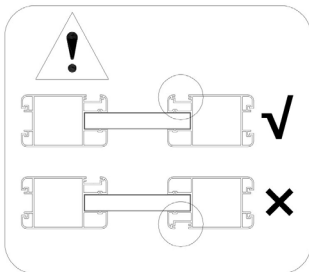
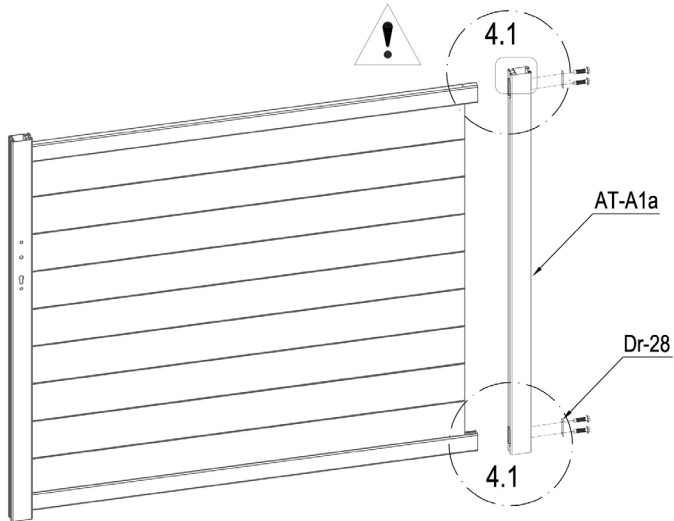

	SR-C4	8
-------------------------------------------------------------------------------------	-------	---

Part A.



	AT-A1a	1
	Dr-28	2
	CKW-E32	4

Part A.

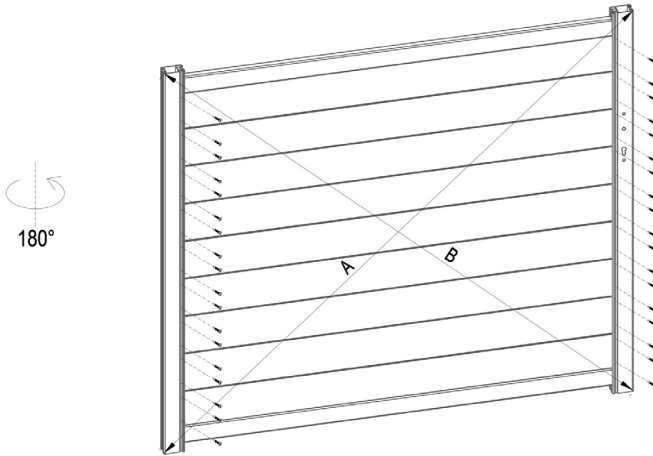

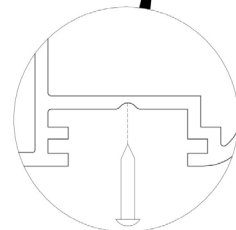
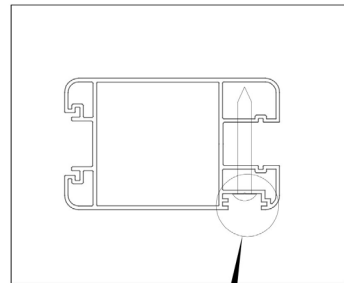
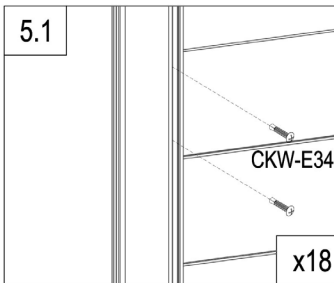

A=B

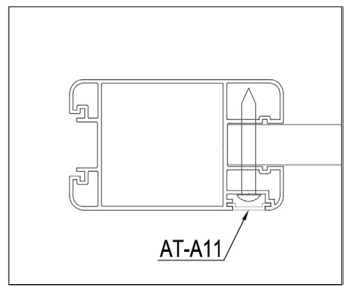
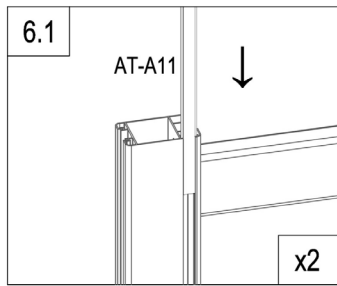
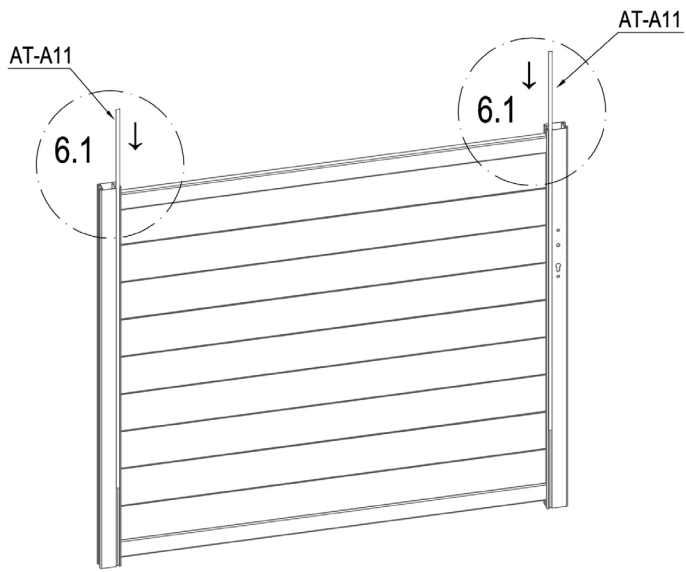

	CKW-E34	36
-------------------------------------------------------------------------------------	---------	----

Part A.



	AT-A11	2
-------------------------------------------------------------------------------------	--------	---

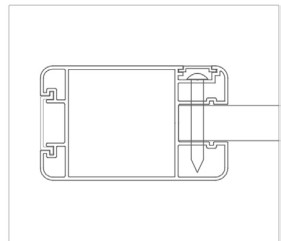
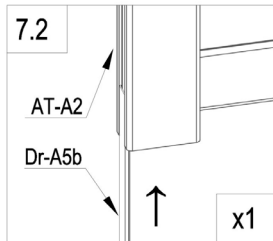
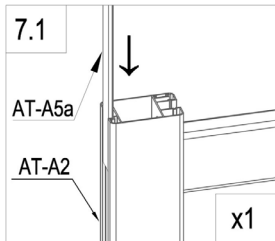
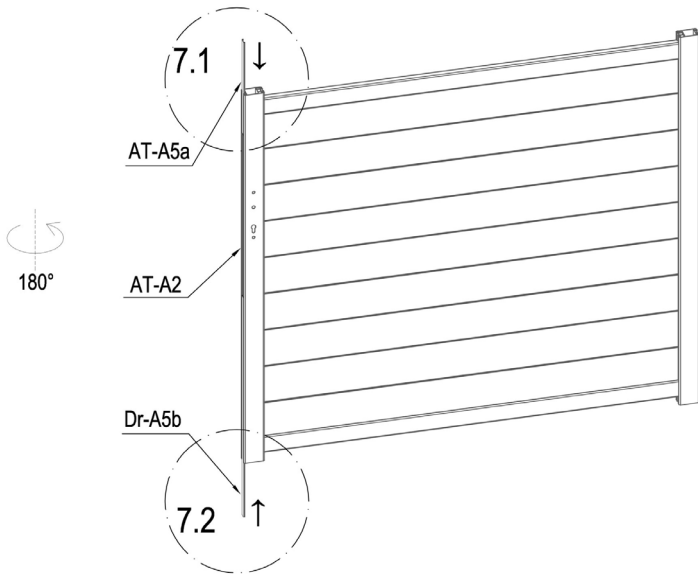

Part A.

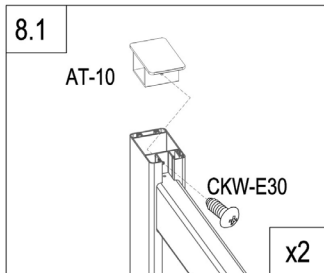
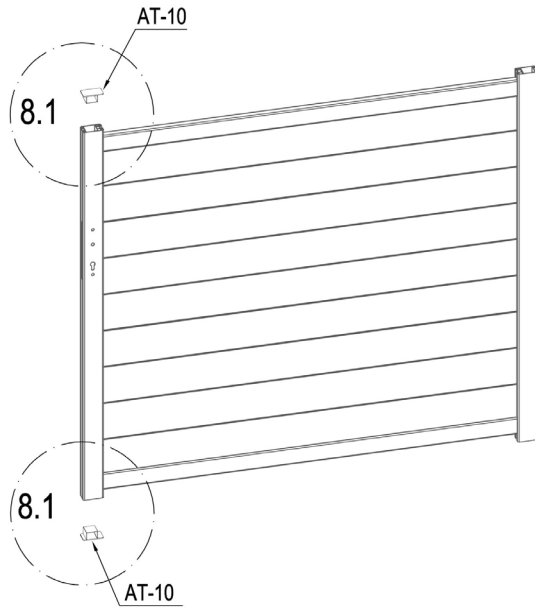

	AT-A5a	1
	Dr-A5b	1

Part A.



	AT-10	2
	CKW-E30	2

Part B.

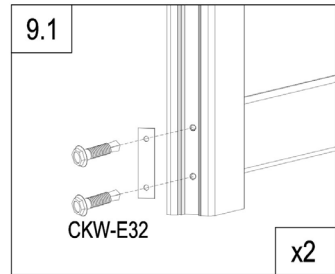
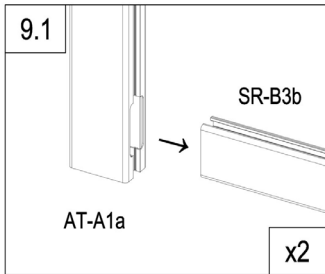
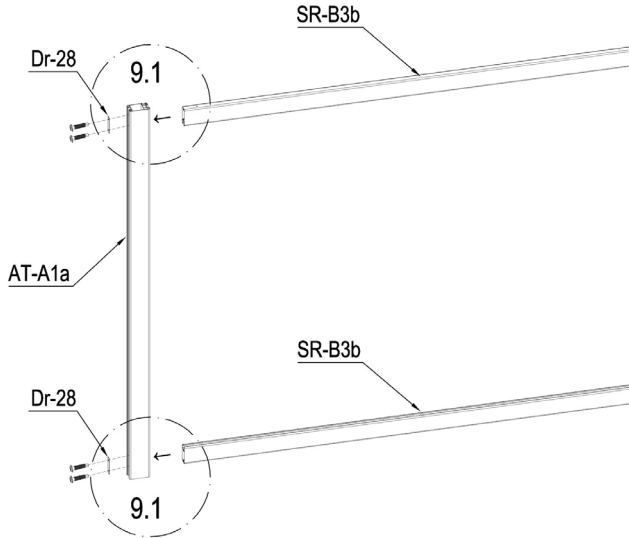

	AT-A1a	1
	SR-B3b	2
	Dr-28	2
	CKW-E32	4

Part B.

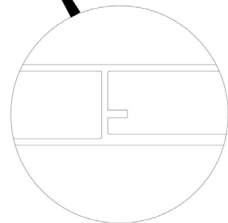
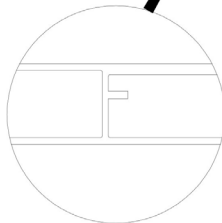
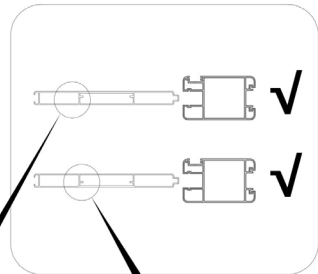
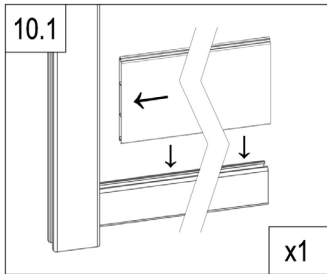
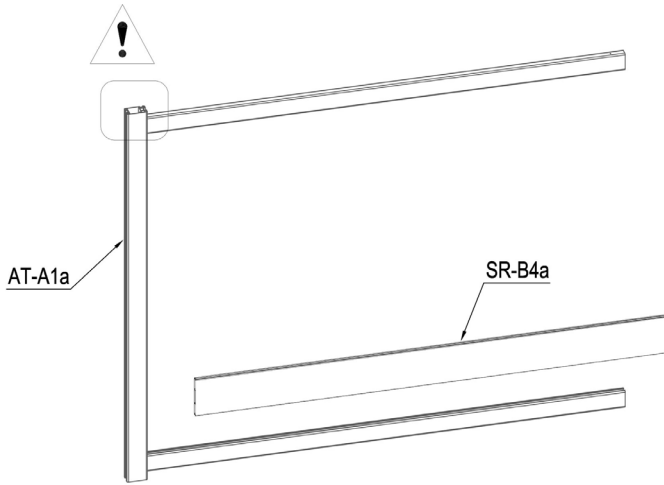

	SR-B4a	1
-------------------------------------------------------------------------------------	--------	---

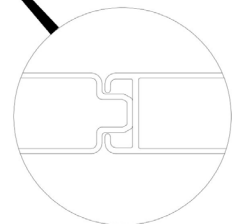
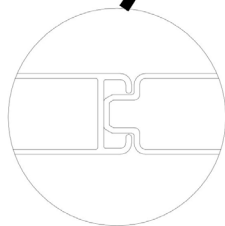
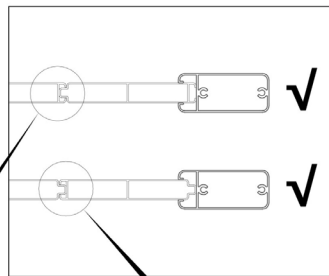
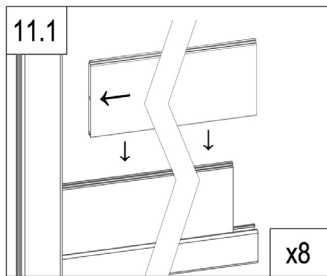
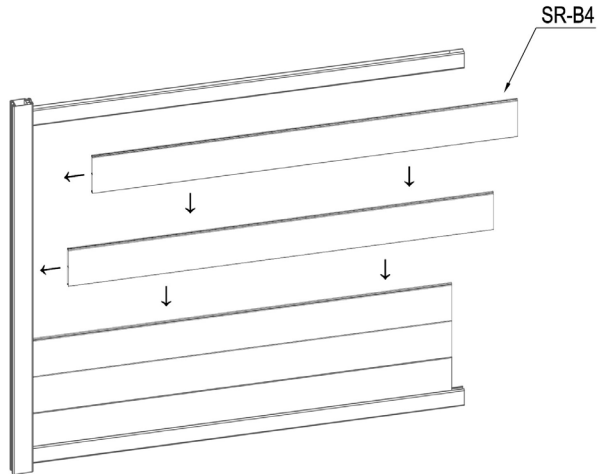

Part B.

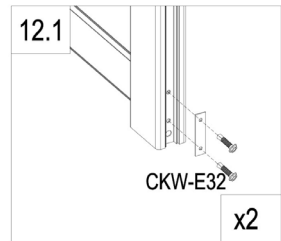
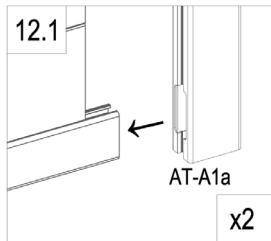
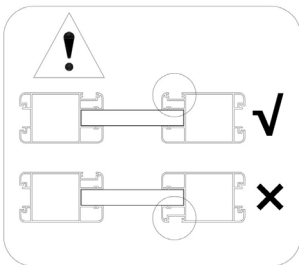
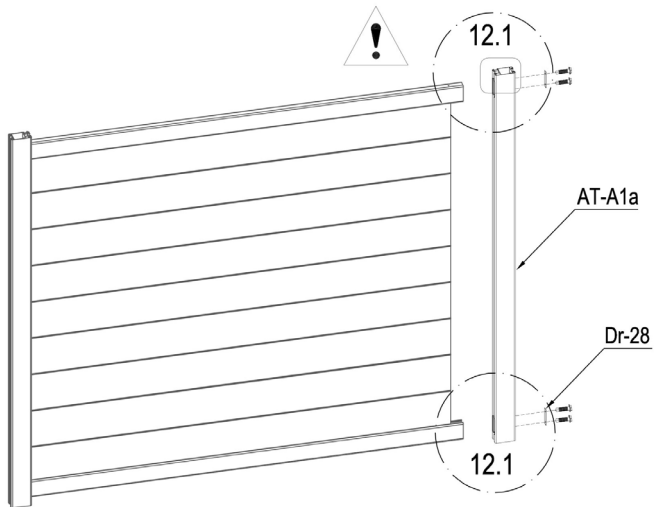

	SR-B4	8
-------------------------------------------------------------------------------------	-------	---

Part B.



	AT-A1a	1
	Dr-28	2
	CKW-E32	4

Part B.

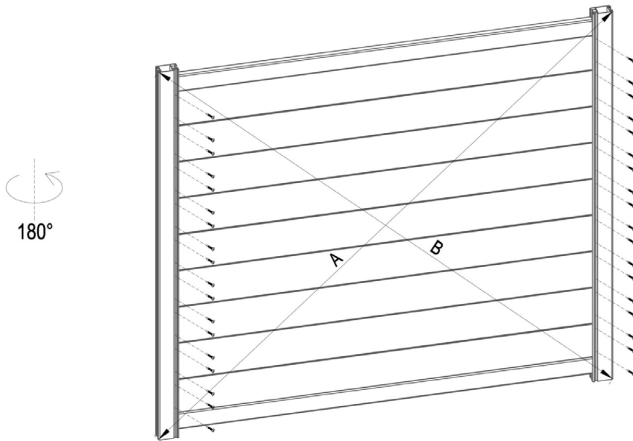

A=B

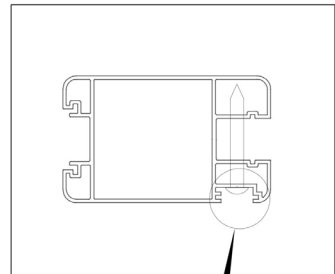
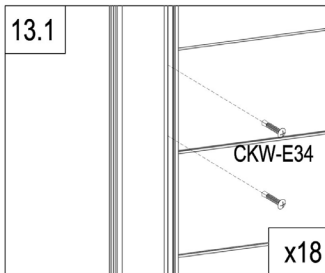



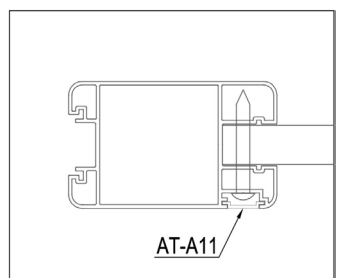
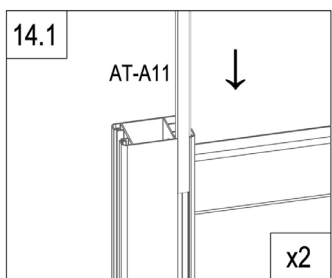
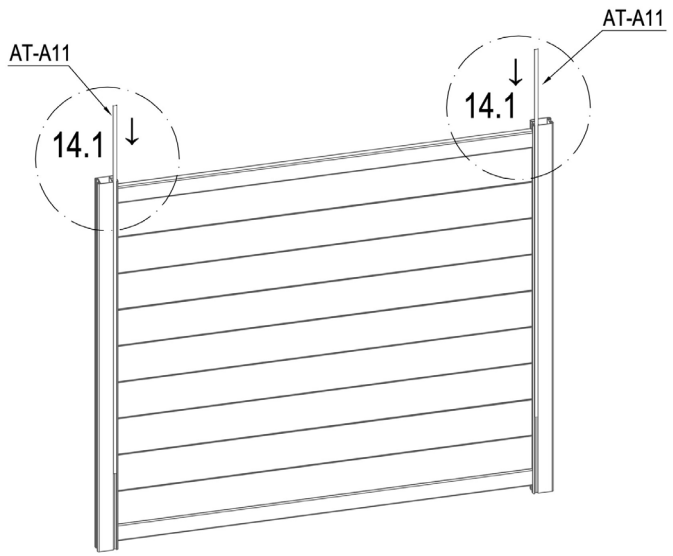

Part B.

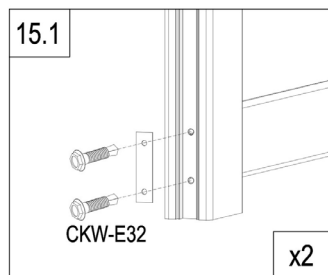
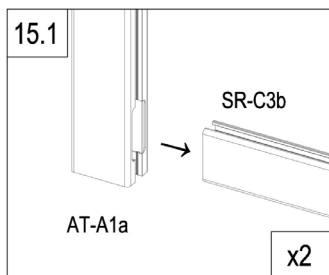
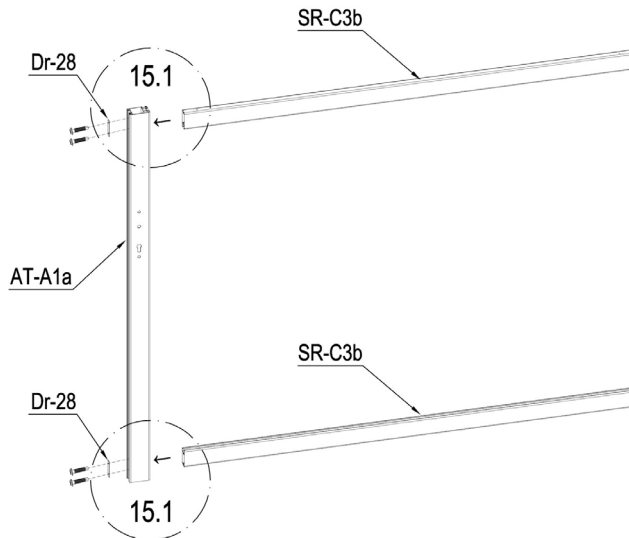

	AT-A11	2
-------------------------------------------------------------------------------------	--------	---

Part C.



	AT-A1a	1
	SR-C3b	2
	Dr-28	2
	CKW-E32	4

Part C.

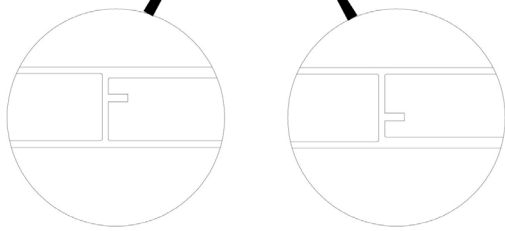
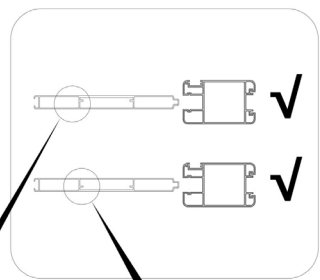
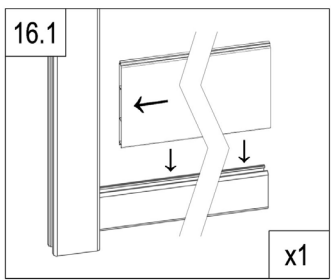
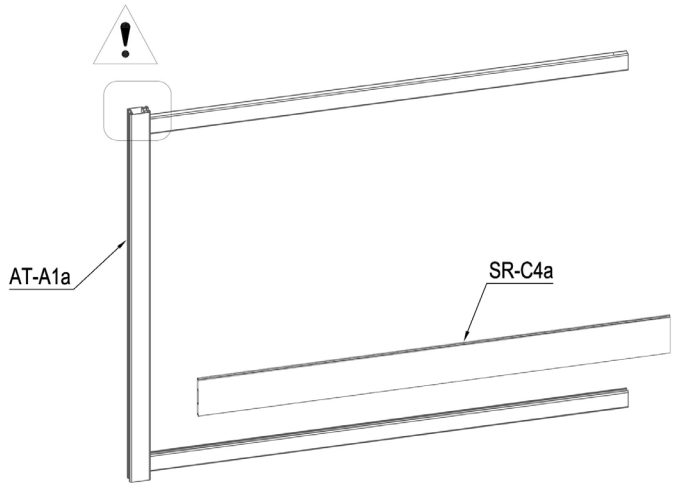

	SR-C4a	1
--	--------	---

Part C.

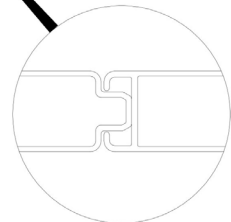
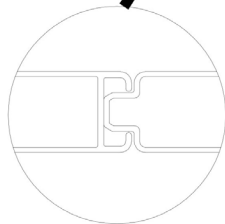
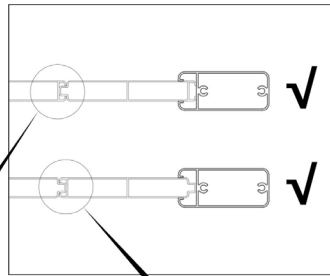
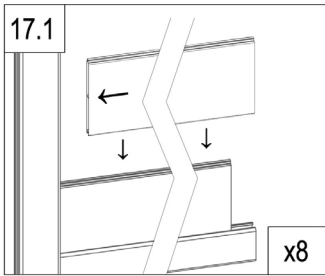
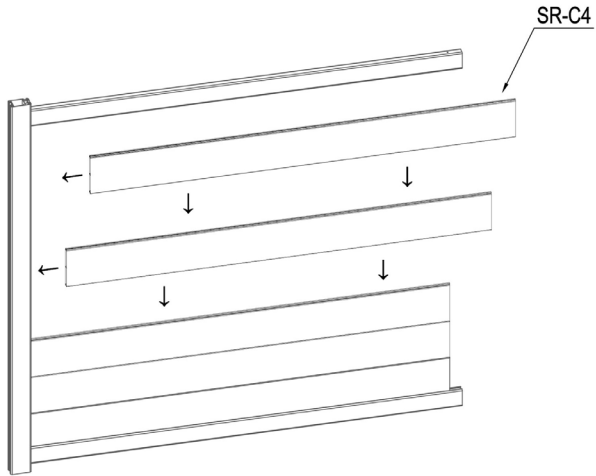

	SR-C4	8
-------------------------------------------------------------------------------------	-------	---

Part C.

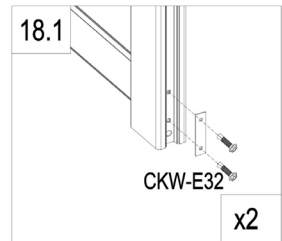
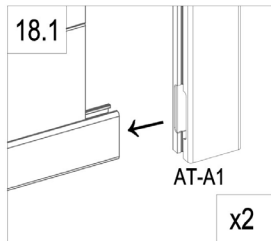
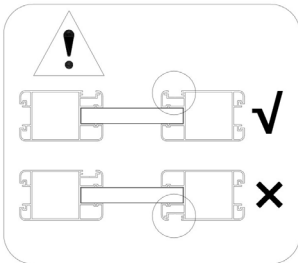
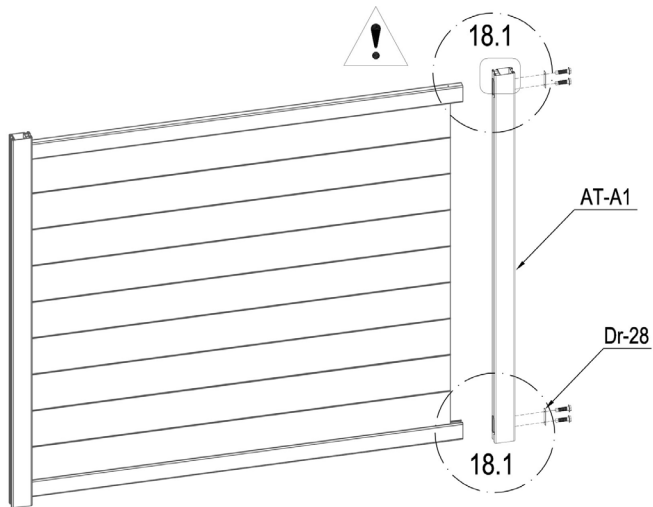

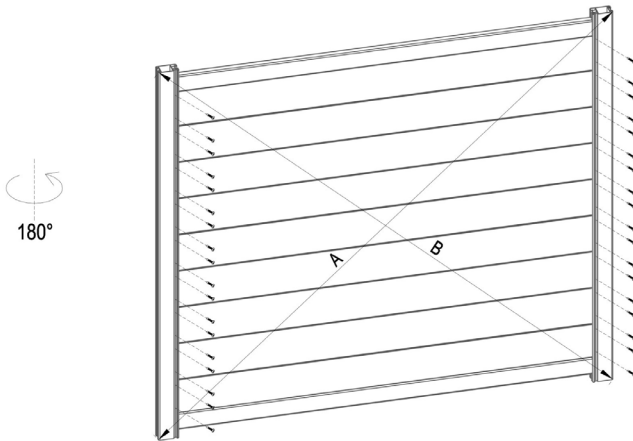

	AT-A1	1
	Dr-28	2
	CKW-E32	4

Part C.



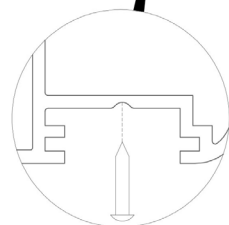
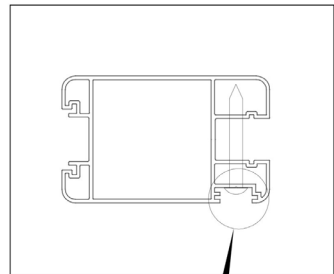
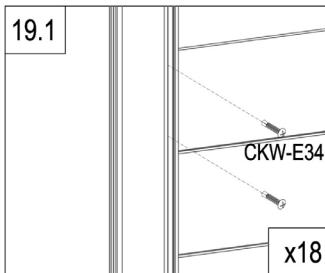

A=B

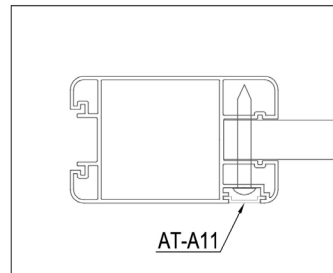
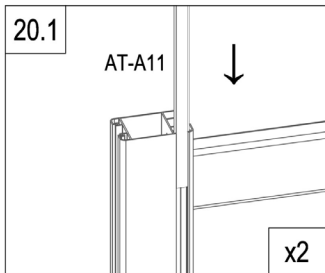
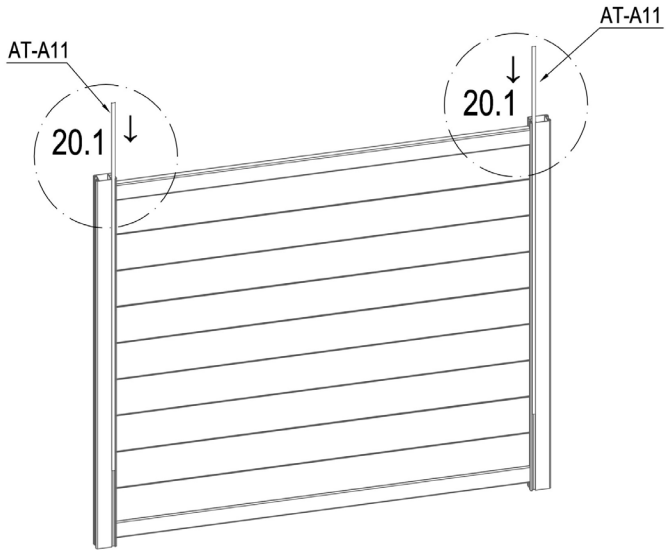

	CKW-E34	36
-------------------------------------------------------------------------------------	---------	----

Part C.



	AT-A11	2
-------------------------------------------------------------------------------------	--------	---

Part C.

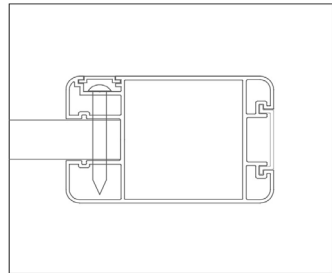
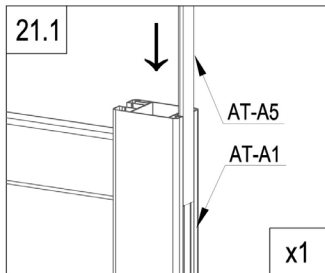
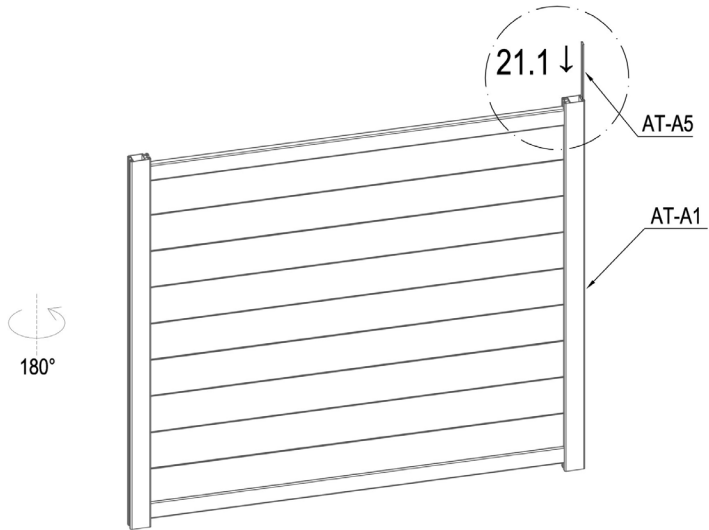



Part C.

]	AT-A5	1
---	-------	---

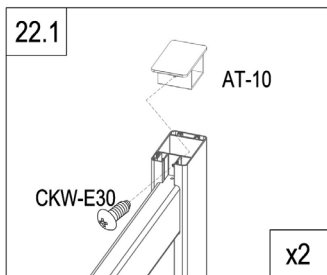
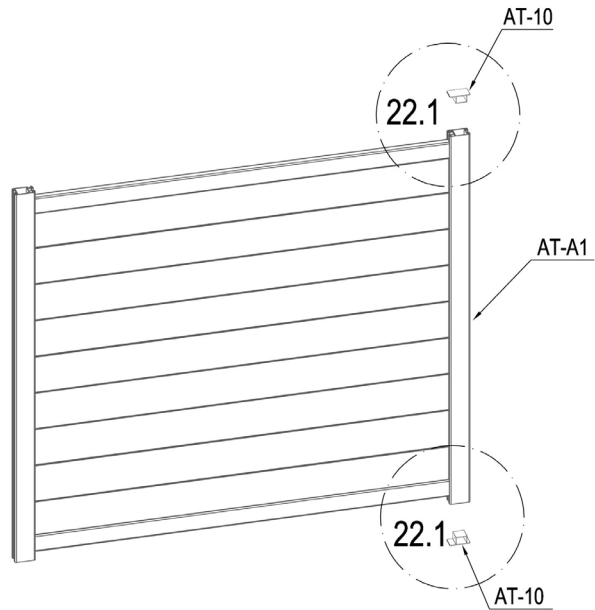
Part C.



Part C.

	AT-10	2
	CKW-E30	2

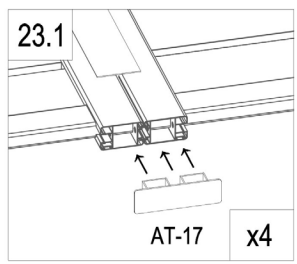
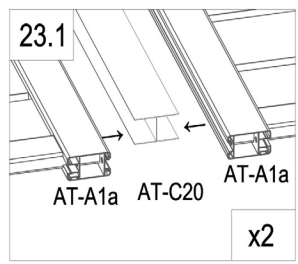
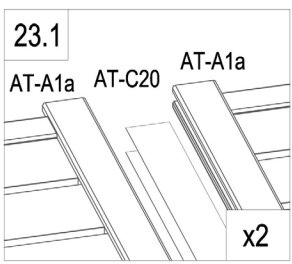
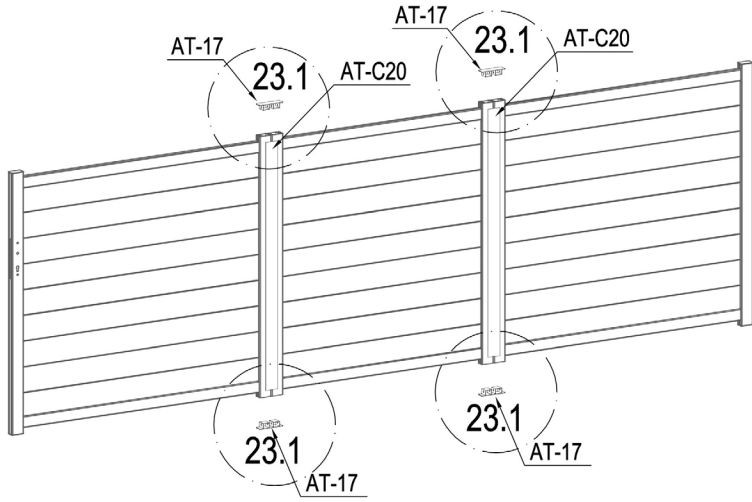

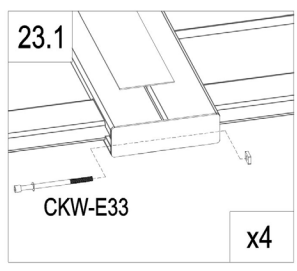

	AT-C20	2
	AT-17	4
	CKW-E33	4

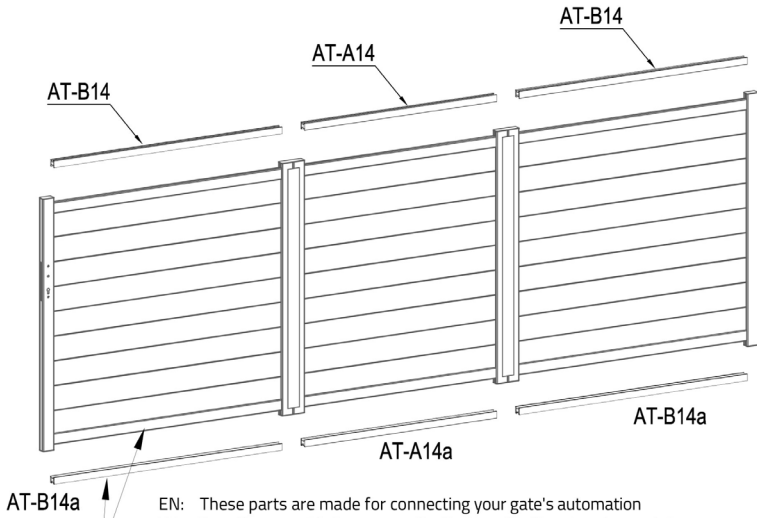



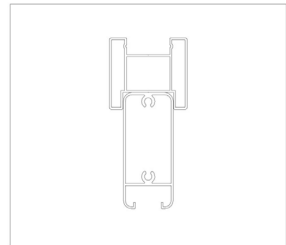
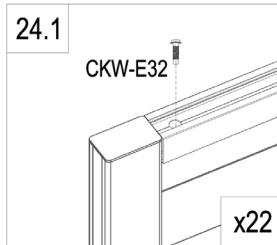
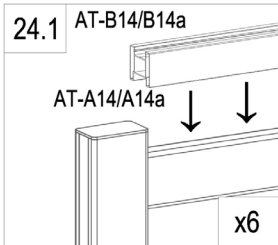



EN: These parts are made for connecting your gate's automation
 FR: Ces pièces sont faites pour relier l'automatisation de votre portail
 DE: Diese Teile sind für den Anschluss der Automatisierung Ihres Tores vorgesehen
 ES: Estas piezas están hechas para conectar la automatización de su puerta
 PT: Estas peças são feitas para ligar a automatização do seu portão
 IT: Queste parti sono realizzate per collegare l'automazione del vostro cancello
 NL: Deze onderdelen zijn gemaakt voor het aansluiten van de automatisering van uw poort.
 PL: Te części są wykonane do podłączenia automatyki bramy.



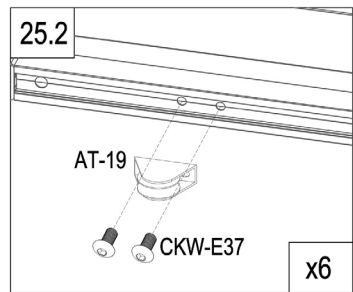
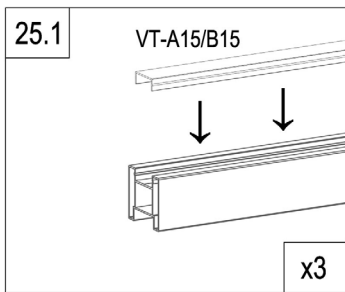
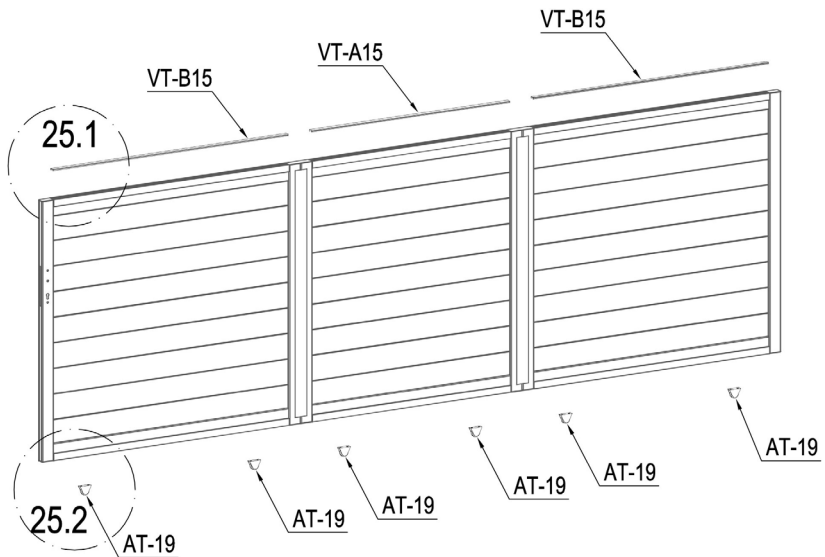



	AT-A14	1
	AT-A14a	1
	CKW-E32	22

	AT-B14	2
	AT-B14a	2

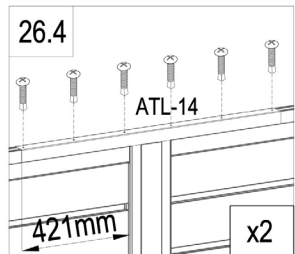
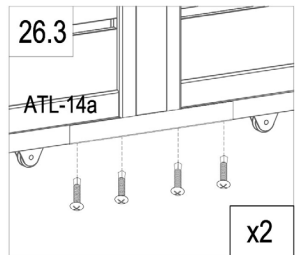
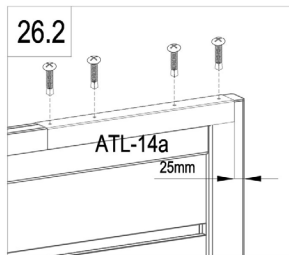
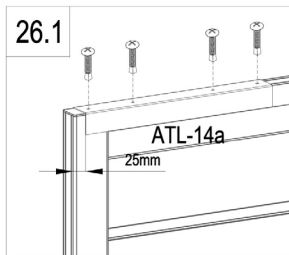
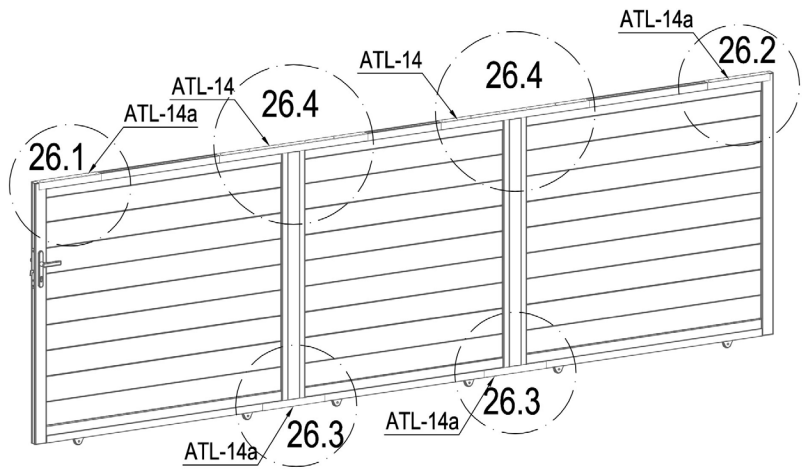

	VT-A15	1
	VT-B15	2
	AT-19	6
	CKW-E37	24



	ATL-14	2
	ATL-14a	4
	CKW-E34	28

Ext.

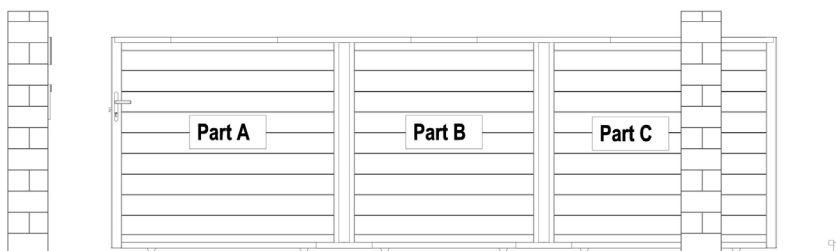

Int.

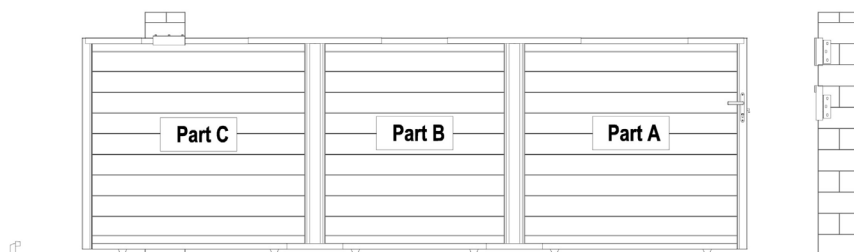

L : P27~33

Ext.

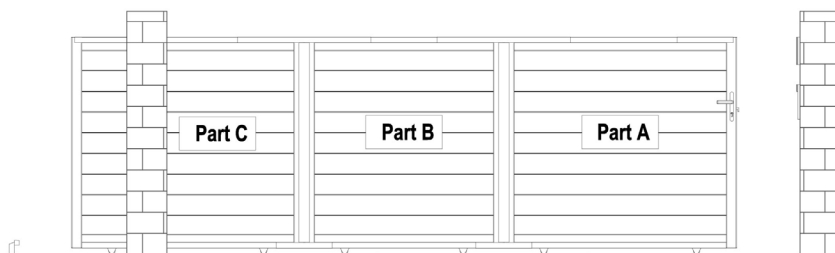

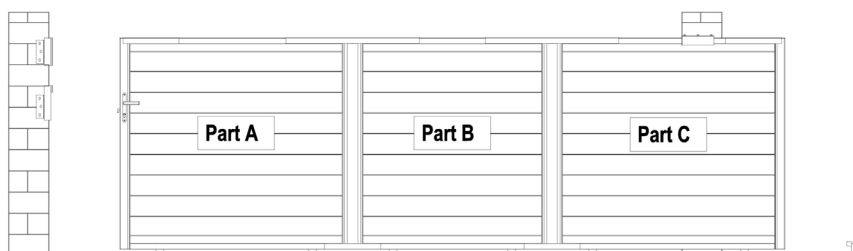

Int.

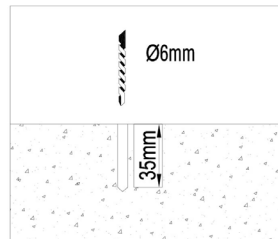
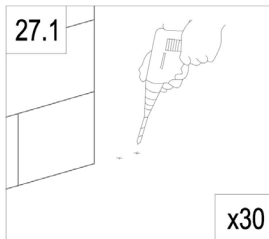
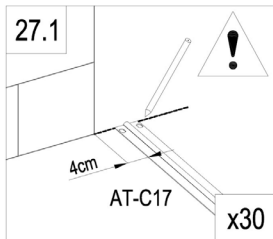
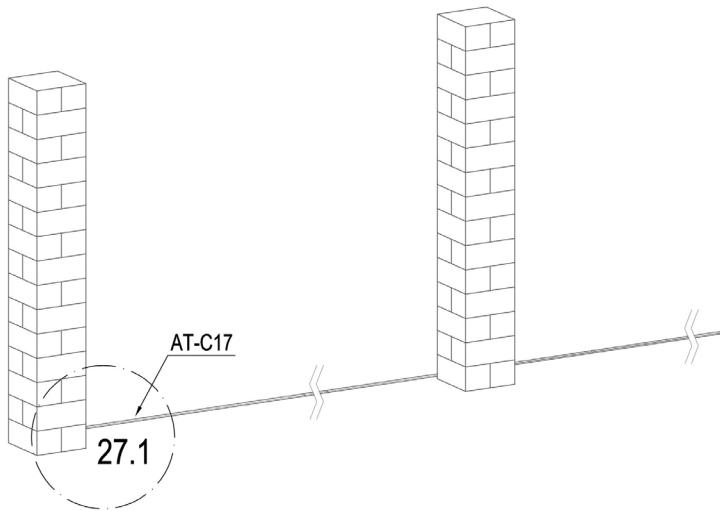

R : P34~40

L



	AT-C17	6
	CKW-E38	60

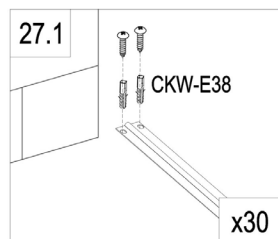

L

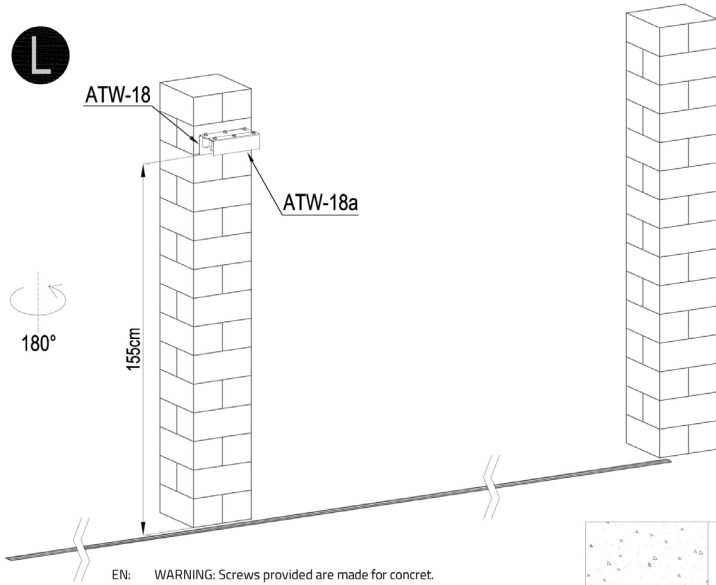

EN: WARNING: Screws provided are made for concrete.
 FR: AVERTISSEMENT : Les vis fournies sont faites pour le béton.
 DE: WARNUNG: Die mitgelieferten Schrauben sind für Beton ausgelegt.
 ES: ADVERTENCIA: Los tornillos suministrados están hechos para el hormigón.
 IT: ATTENZIONE: Le viti fornite sono fatte per il calcestruzzo.
 NL: WAARSCHUWING: De bijgeleverde schroeven zijn gemaakt voor beton.
 PL: OSTRZEŻENIE: Dostarczone śruby są przeznaczone do betonu.
 PT: AVISO: Os parafusos fornecidos são feitos para betão.

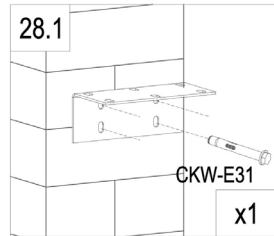
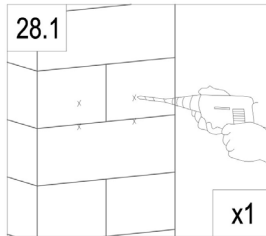
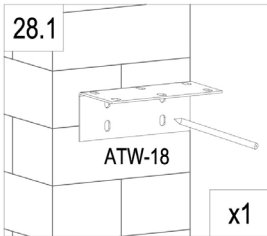
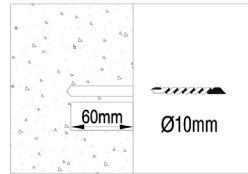

	ATW-18	1
	ATW-18a	1
	AT-20	6
	CKW-E31	4

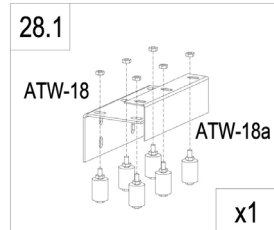
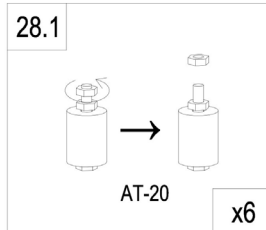

L

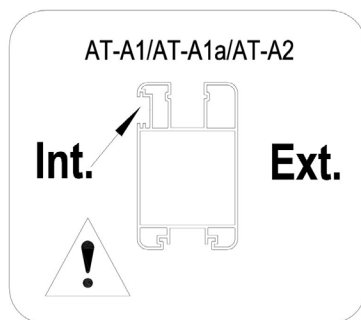
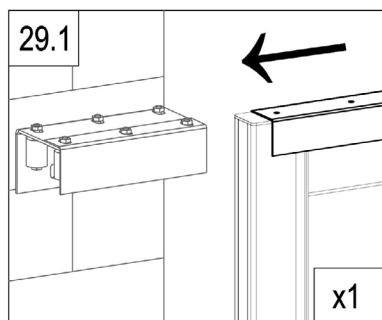
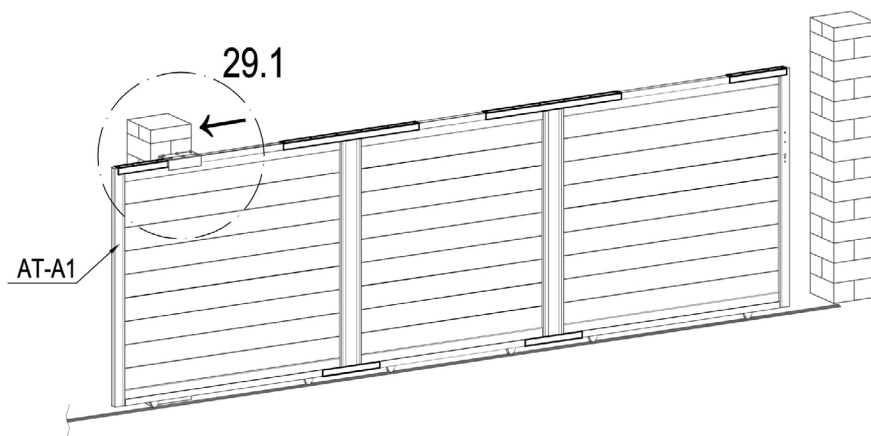

L

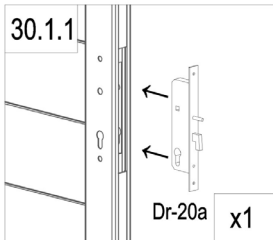
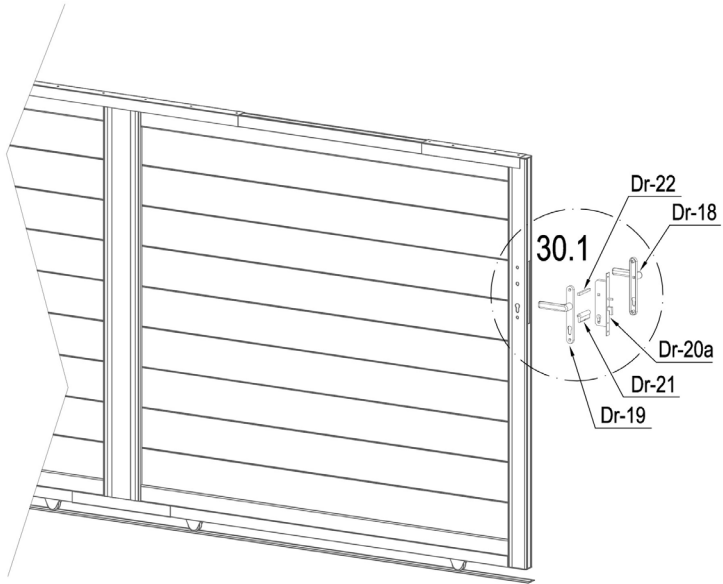

	Dr-20a	1
	Dr-21	1
	Dr-22	1
	Dr-25	1

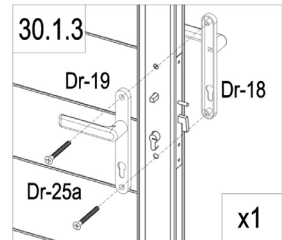
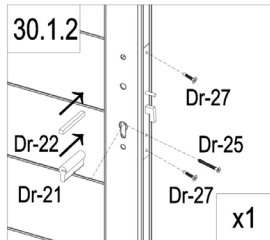

	Dr-18	1
	Dr-19	1
	Dr-25a	2
	Dr-27	2

L

EN: WARNING: Screws provided are made for concret.
 FR: AVERTISSEMENT : Les vis fournies sont faites pour le béton.
 DE: WARNUNG: Die mitgelieferten Schrauben sind für Beton ausgelegt.
 ES: ADVERTENCIA: Los tornillos suministrados están hechos para el hormigón.
 IT: ATTENZIONE: Le viti fornite sono fatte per il calcestruzzo.
 NL: WAARSCHUWING: De bijgeleverde schroeven zijn gemaakt voor beton.
 PL: OSTRZEŻENIE: Dostarczone śruby są przeznaczone do betonu.
 PT: AVISO: Os parafusos fornecidos são feitos para betão.

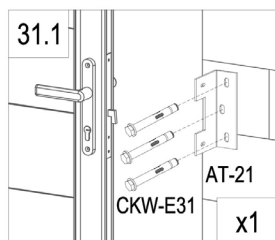
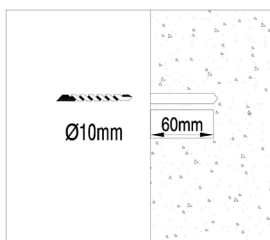
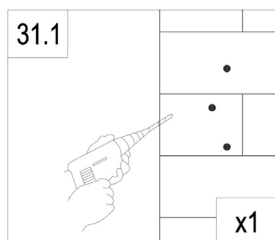
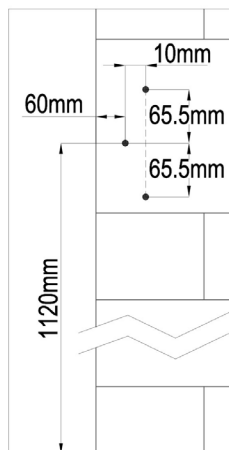
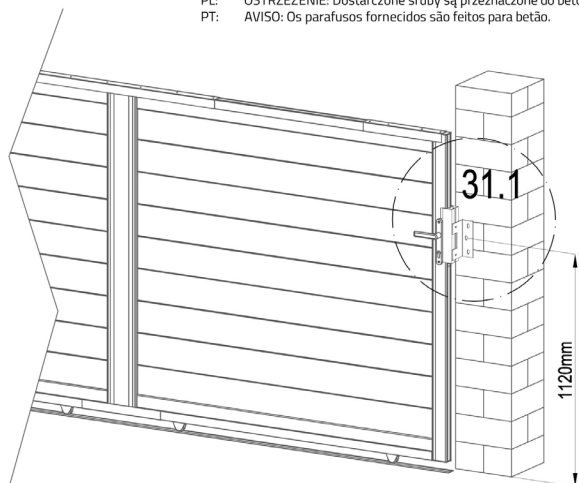

	AT-16	1
	AT-21	1
	CKW-E36	2
	CKW-E31	3
	ATW-22J	3

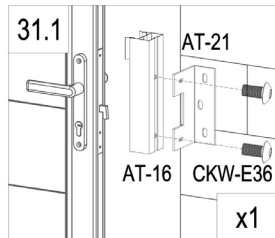
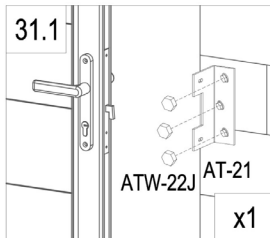

L

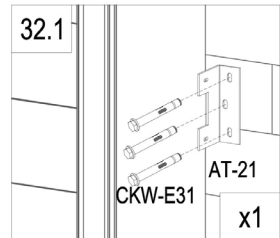
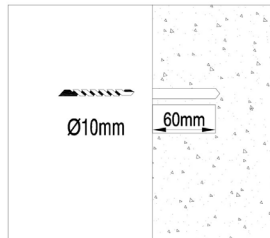
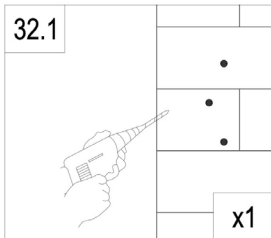
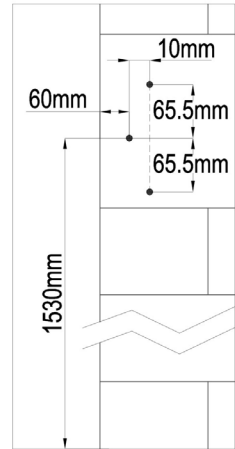
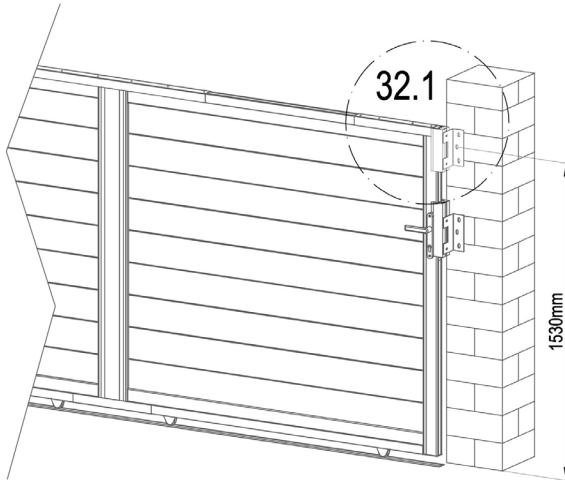

	AT-16a	1
	AT-21	1
	CKW-E36	2
	CKW-E31	3
	ATW-22J	3

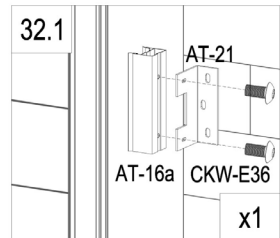
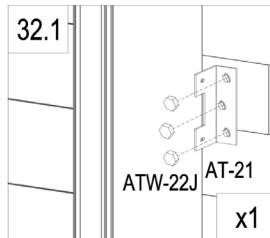

L

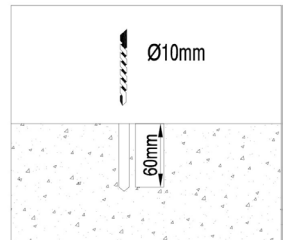
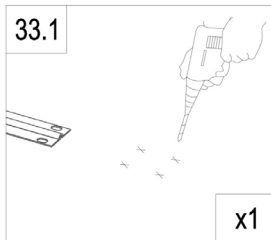
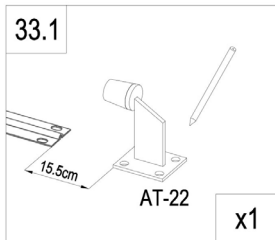
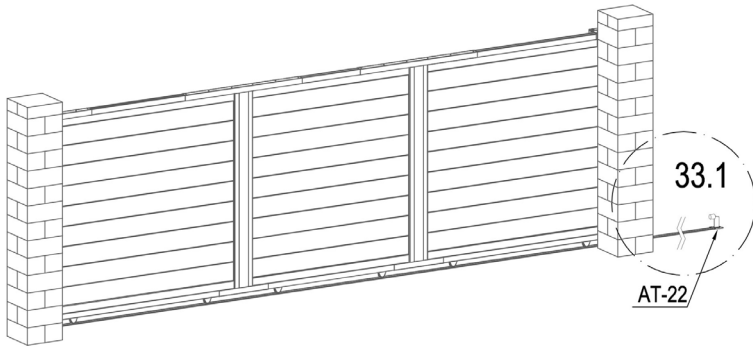

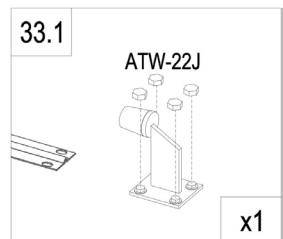
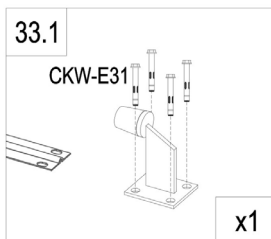

	AT-22	1
	CKW-E31	4
	ATW-22J	4

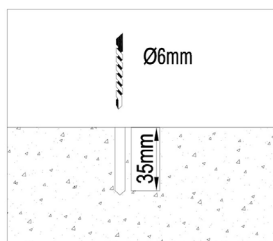
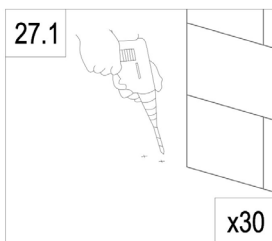
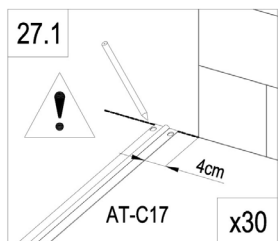
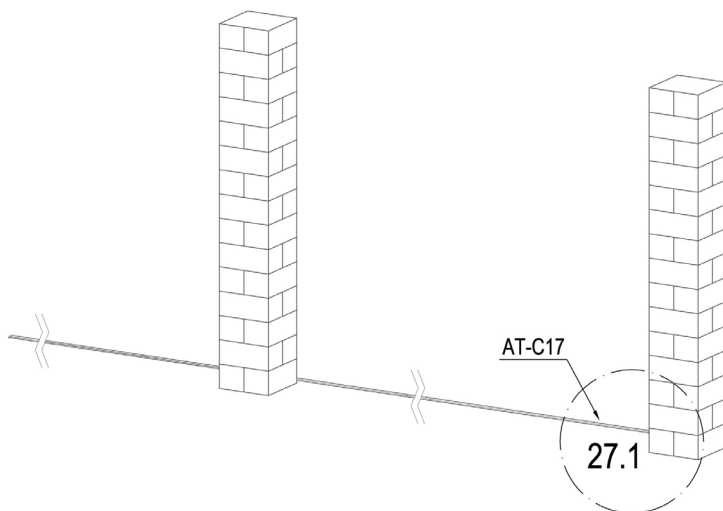

R



	AT-C17	6
	CKW-E38	60

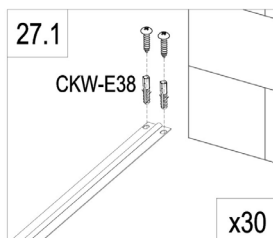

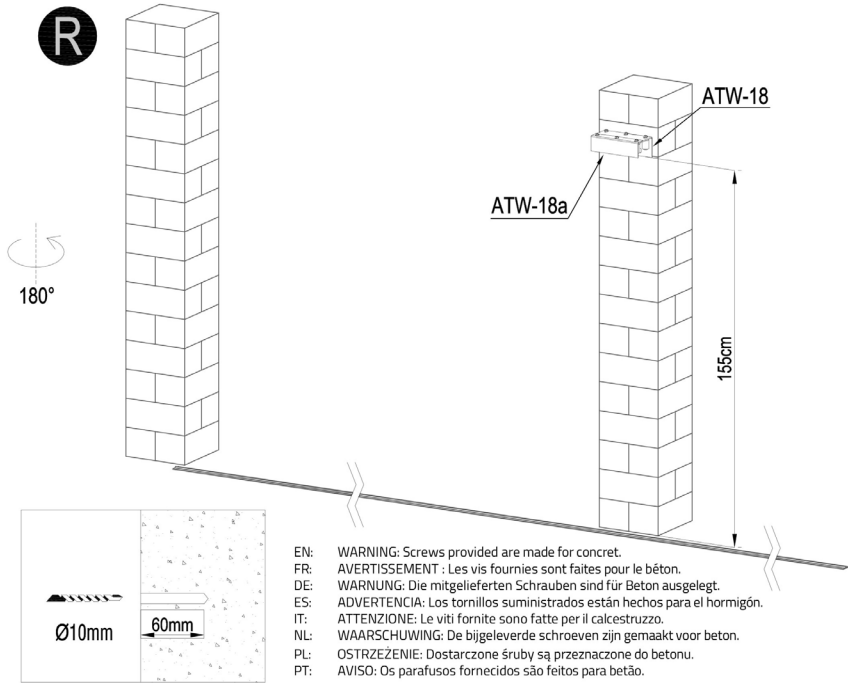

EN: WARNING: Screws provided are made for concrete.
 FR: AVERTISSEMENT - Les vis fournies sont faites pour le béton.
 DE: WARNUNG: Die mitgelieferten Schrauben sind für Beton ausgelegt.
 ES: ADVERTENCIA: Los tornillos suministrados están hechos para el hormigón.
 IT: ATTENZIONE: Le viti fornite sono fatte per il calcestruzzo.
 NL: WAARSCHUWING: De bijgeleverde schroeven zijn gemaakt voor beton.
 PL: OSTRZEŻENIE: Dostarczone śruby są przeznaczone do betonu.
 PT: AVISO: Os parafusos fornecidos são feitos para betão.

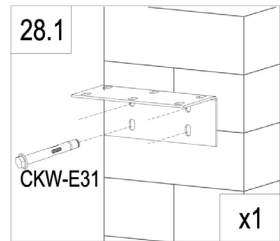
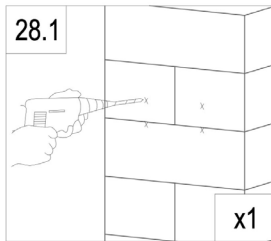
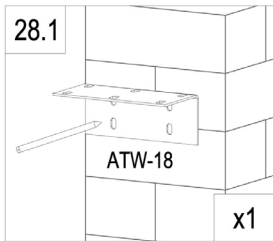

	ATW-18	1
	ATW-18a	1
	AT-20	6
	CKW-E31	4

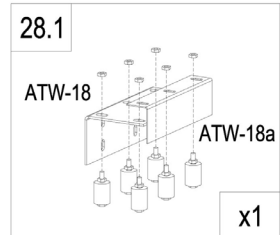
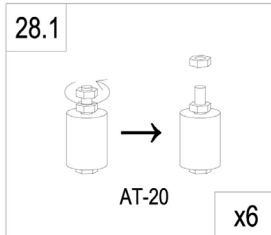



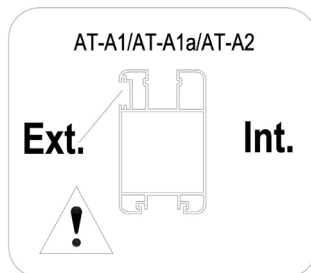
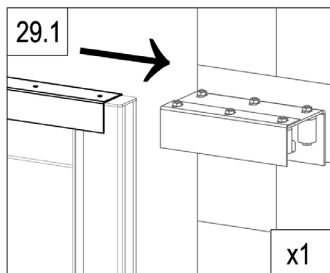
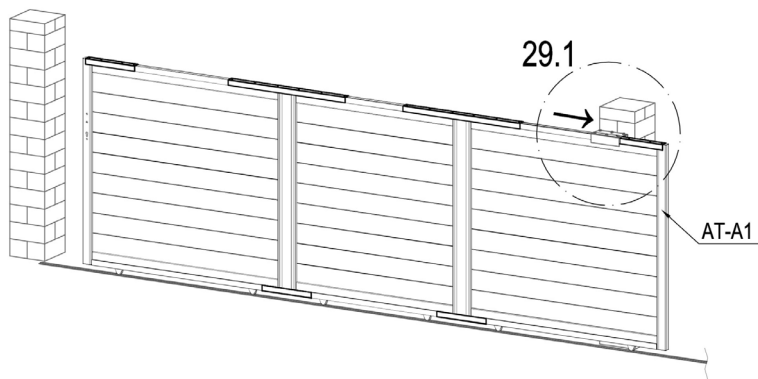

R

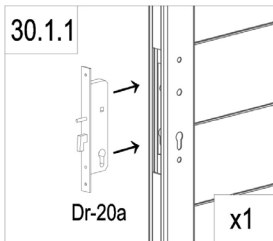
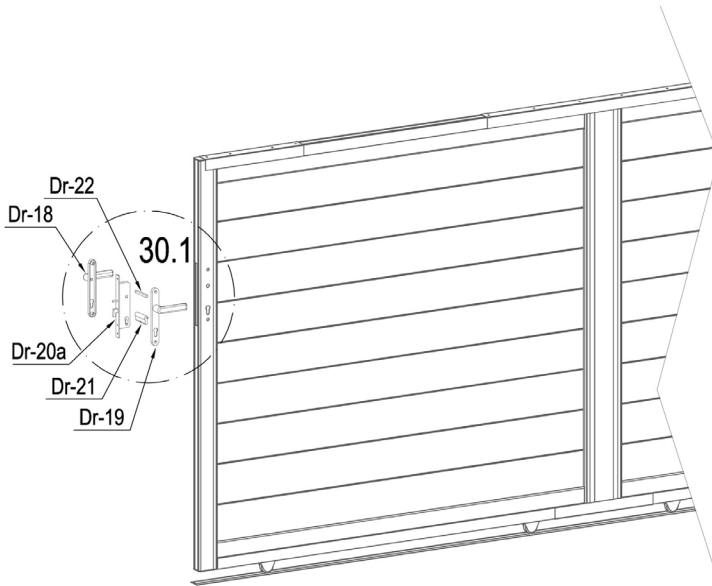





R

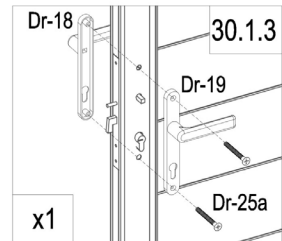
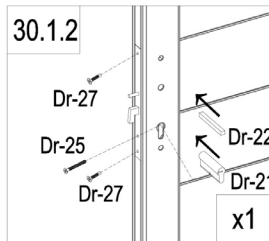

	Dr-20a	1
	Dr-21	1
	Dr-22	1
	Dr-25	1



	Dr-18	1
	Dr-19	1
	Dr-25a	2
	Dr-27	2



EN: WARNING: Screws provided are made for concrete.
 FR: AVERTISSEMENT : Les vis fournies sont faites pour le béton.
 DE: WARNUNG: Die mitgelieferten Schrauben sind für Beton ausgelegt.
 ES: ADVERTENCIA: Los tornillos suministrados están hechos para el hormigón.
 IT: ATTENZIONE: Le viti fornite sono fatte per il calcestruzzo.
 NL: WAARSCHUWING: De bijgeleverde schroeven zijn gemaakt voor beton.
 PL: OSTRZEŻENIE: Dostarczone śruby są przeznaczone do betonu.
 PT: AVISO: Os parafusos fornecidos são feitos para betão.

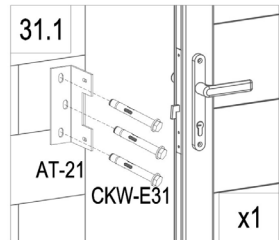
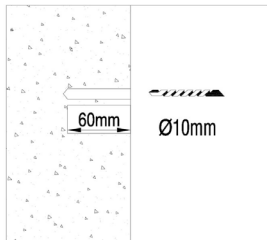
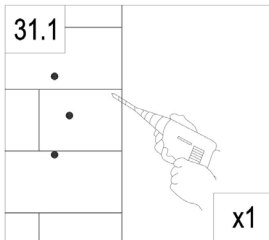
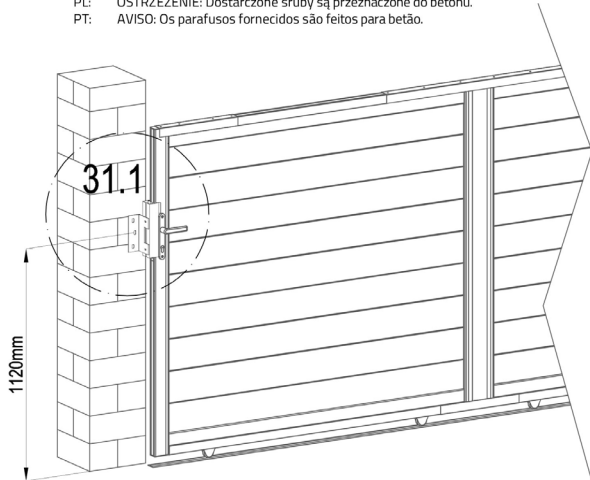
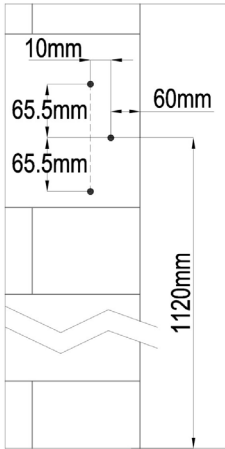

	AT-16	1
	AT-21	1
	CKW-E36	2
	CKW-E31	3
	ATW-22J	3

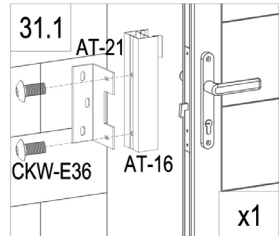
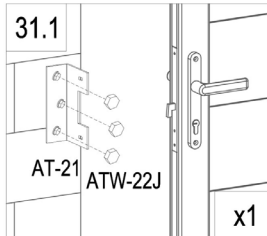

R

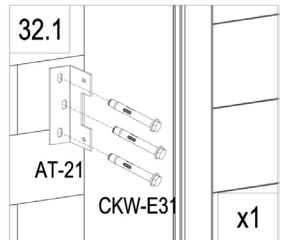
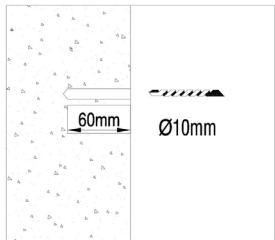
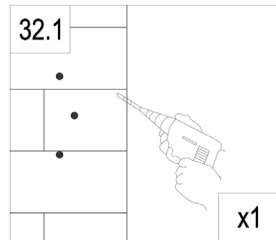
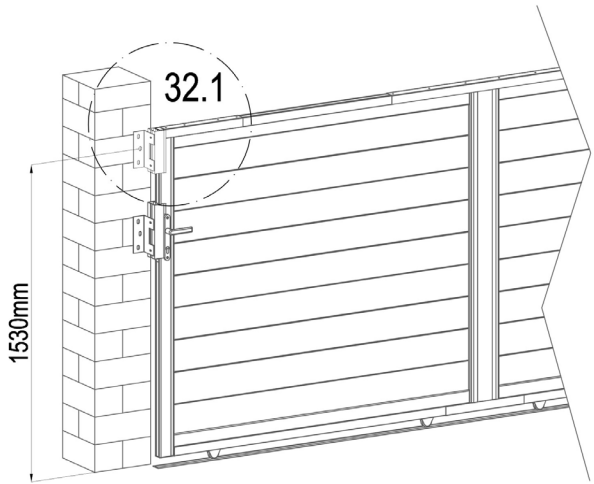
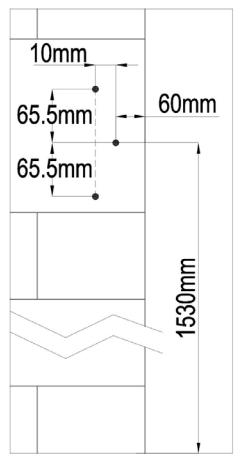

	AT-16a	1
	AT-21	1
	CKW-E36	2
	CKW-E31	3
	ATW-22J	3

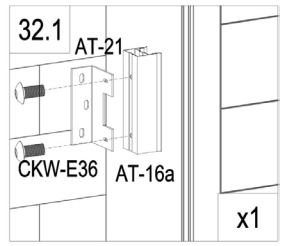
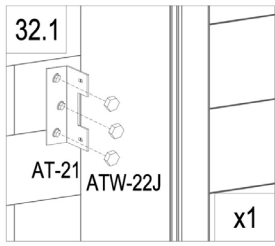

R

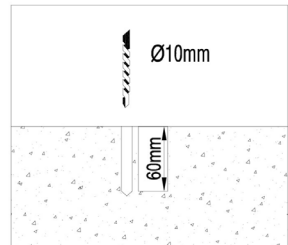
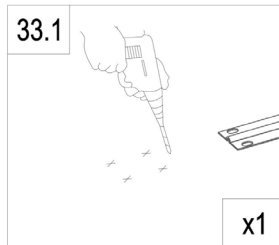
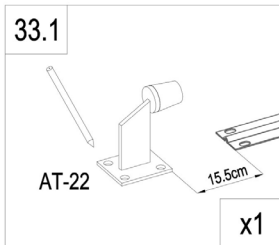
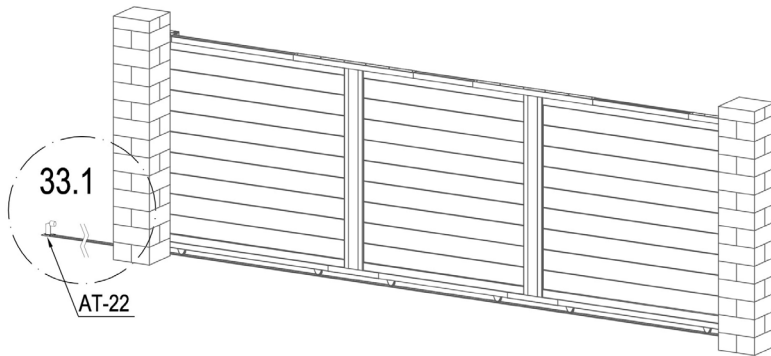

	AT-22	1
	CKW-E31	4
	ATW-22J	4

