

CASANOVO

GIONA 600C160

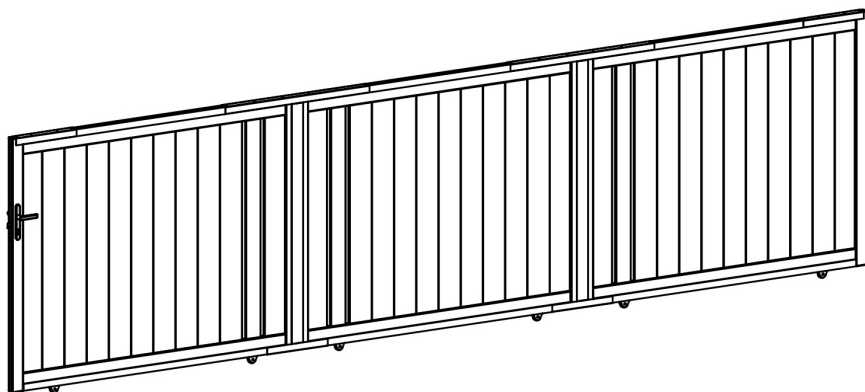

COM-001171 [x1]

COM-001173 [x1]

COM-001175 [x1]

COM-001172 [x1]

COM-001174 [x1]

COM-001176 [x1]



7-8H



X 2



INSTRUCTION MANUAL / NOTICE DE MONTAGE / MONTAGEANLEITUNG / MANUAL DE MONTAJE / MANUAL DE MONTAGEM / MANUALE DI MONTAGGIO /
MONTAGEHANDLEIDING / INSTRUKCJA MONTAŻU / KÄYTTÖOHJEET / BRUKSANVISNING / BRUGSANVISNING / INSTRUCȚIUNI DE ASAMBLARE /
NAVODILA ZA SESTAVLJANJE / NÁVOD NA MONTÁŽ / ÖSSZESZERELÉSI ÚTMUTATÓ / NÁVOD K MONTÁŽI / UPUTE ZA INSTALACIJU /
ΟΔΗΓΙΕΣ ΣΥΝΑΡΜΟΛΟΓΗΣΗΣ / SURINKIMO INSTRUKCIJOS / MONTĀŽAS INSTRUKCIJAS

Ext.

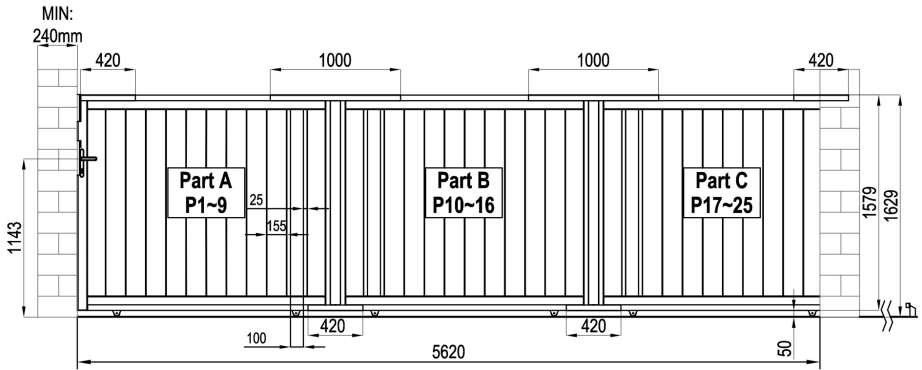

Int.

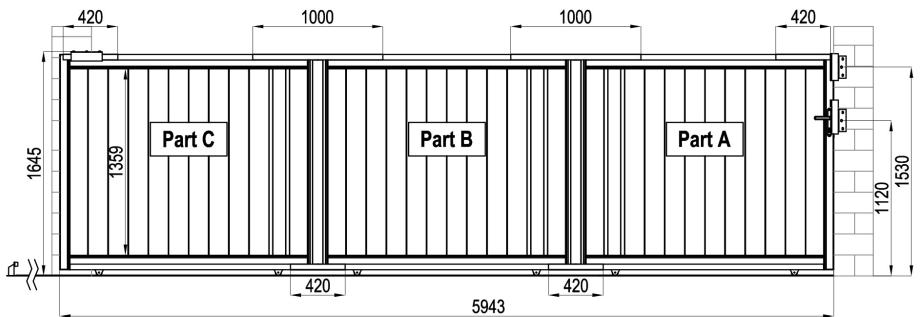

Part A.

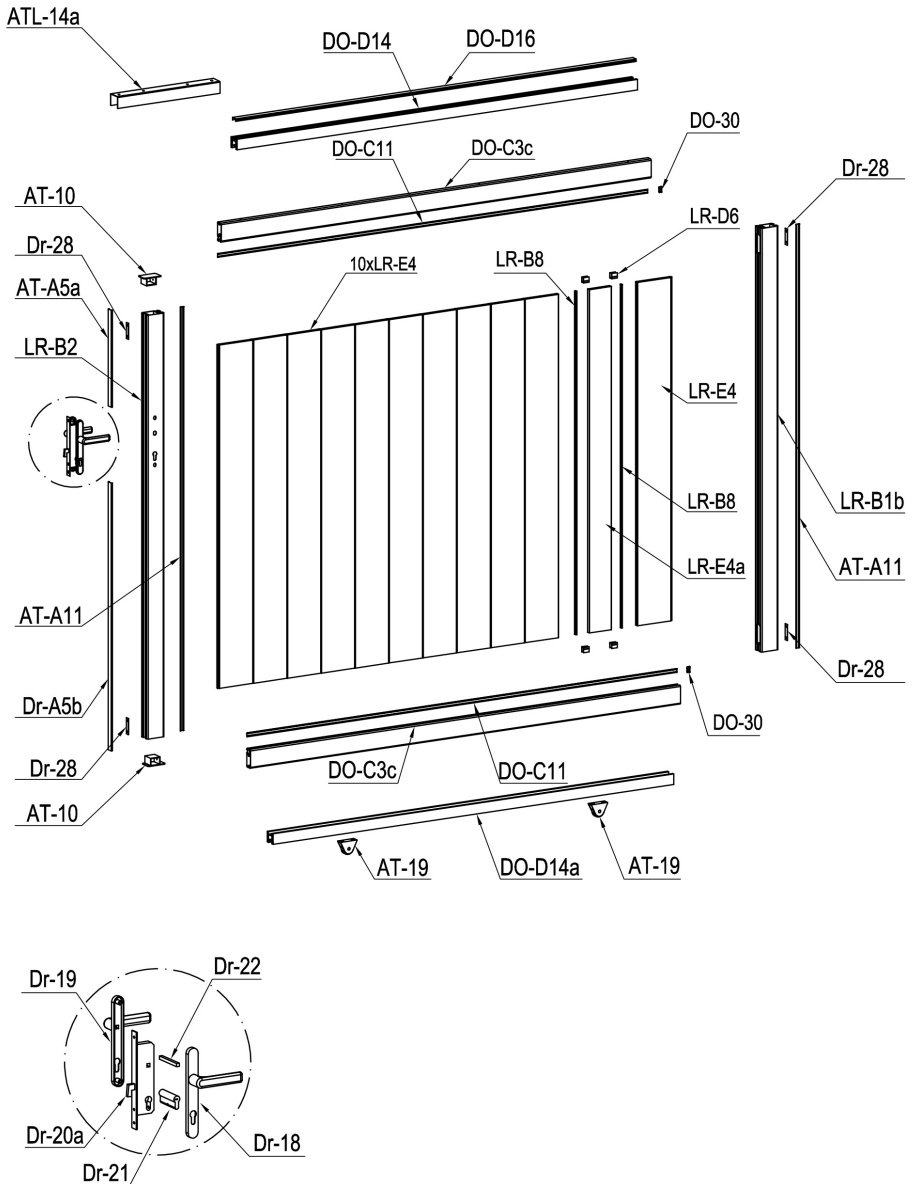

Part B.

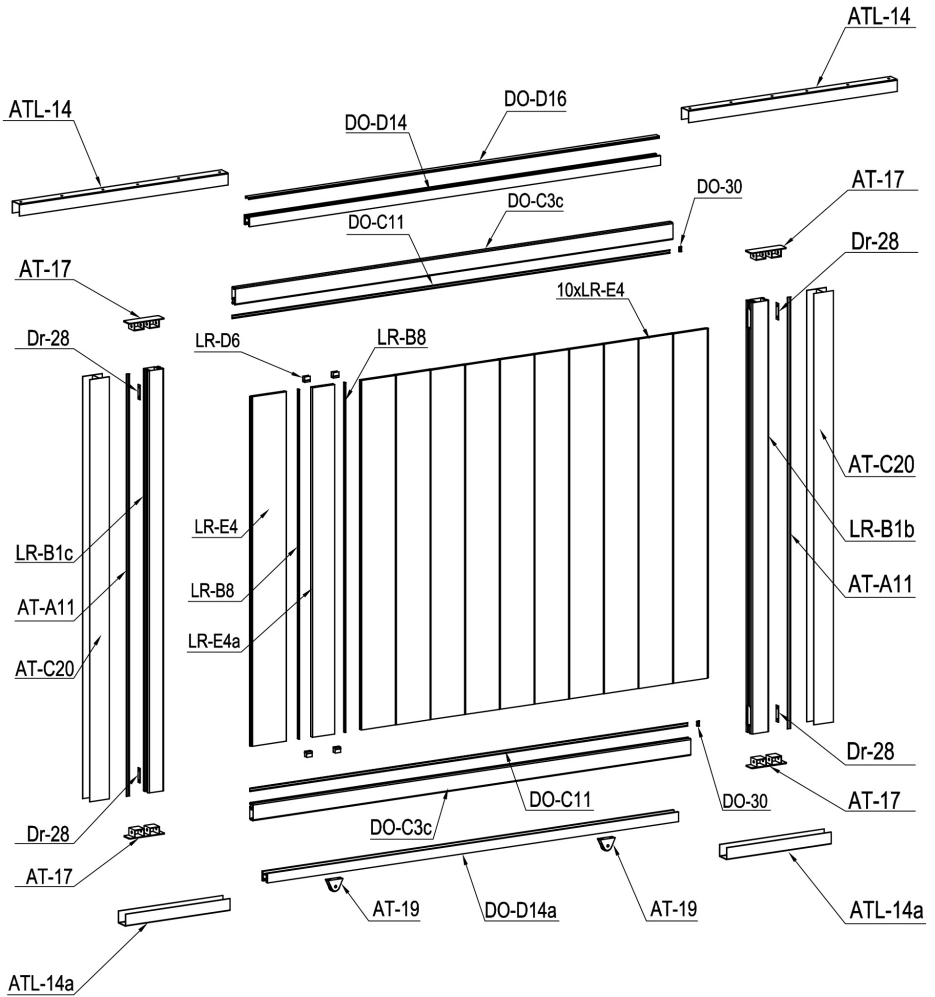



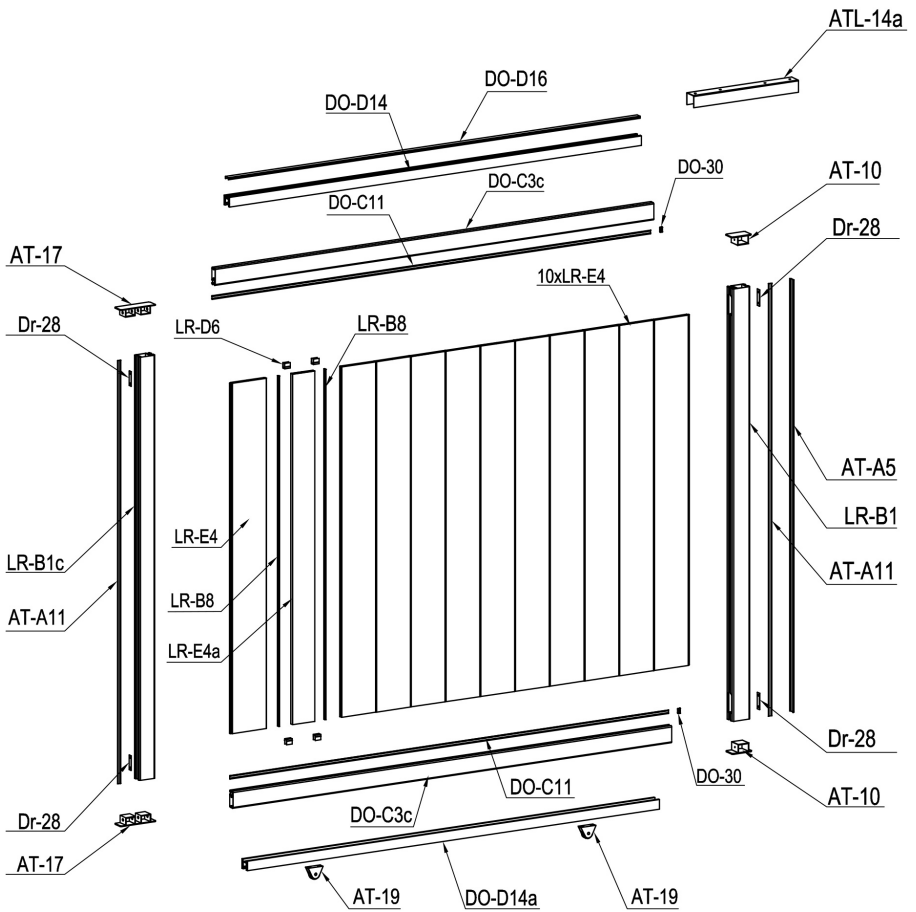

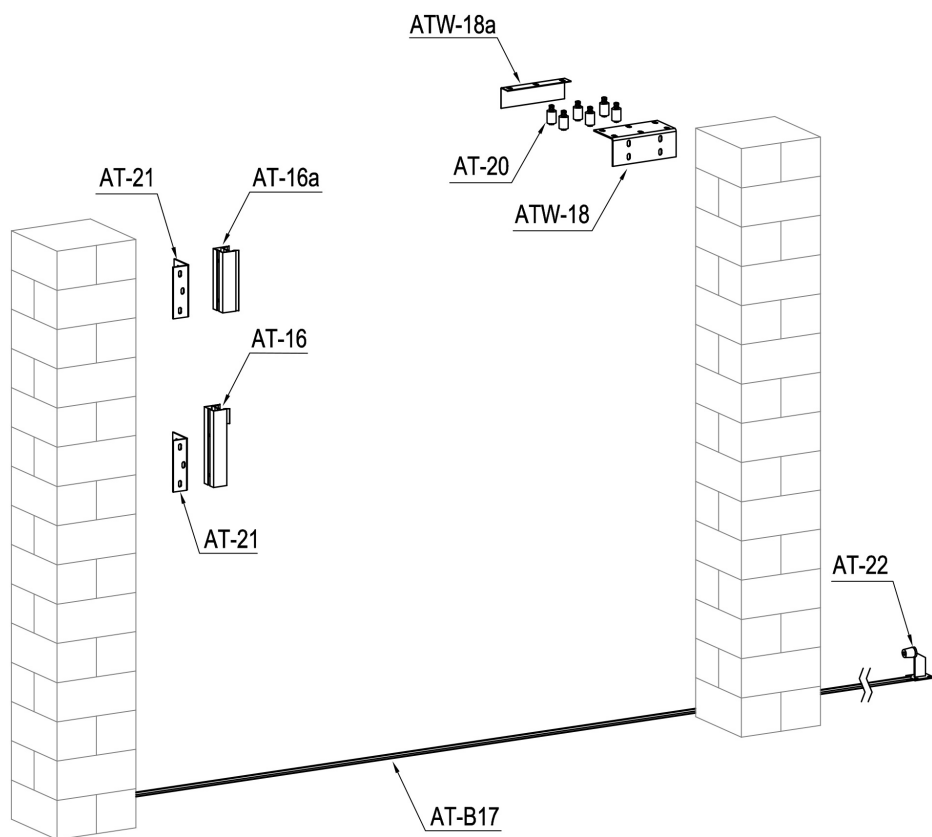





































Part C.







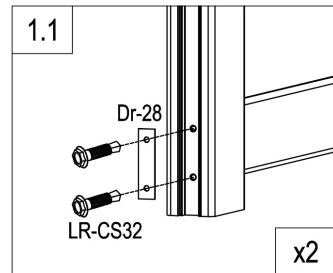
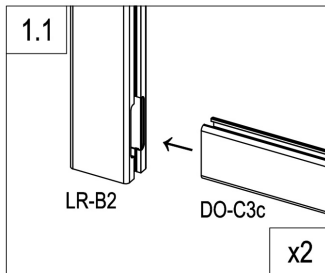
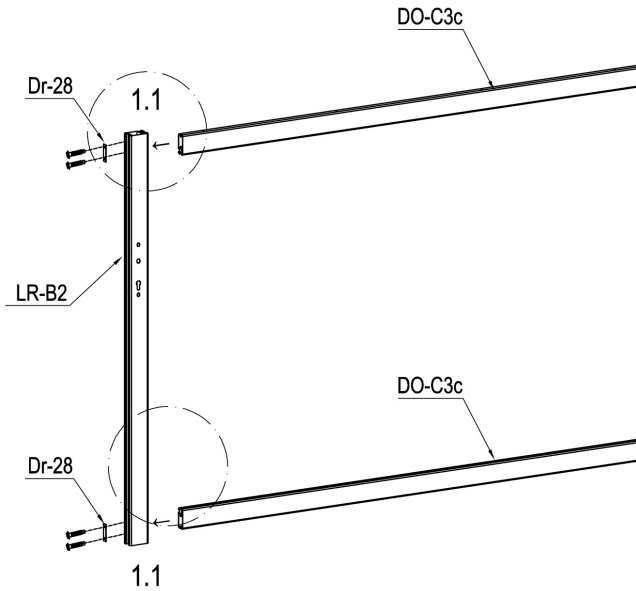

PART LIST

IMAGE	NO.	L.(mm)	QTY	IMAGE	NO.	L.(mm)	QTY
	LR-B1	1573	1		AT-19		6
	LR-B1b	1573	2		AT-20		6
	LR-B1c	1573	2		AT-21		2
	LR-B2	1573	1		AT-22		1
	DO-C3c	1957	6		Dr-18		1
	LR-E4	1400	33		Dr-19		1
	LR-E4a	1400	3		Dr-20a		1
	AT-A5	1573	1		Dr-21		1
	AT-A5a	395.5	1		Dr-22		1
	Dr-A5b	937	1		Dr-25		1
	AT-A11	1573	6		Dr-25a		2
	DO-C11	1957	6		Dr-27		2
	LR-D6	25	12		Dr-28		12
	LR-B8	1400	6		AT-22J		10
	AT-C20	1493	2		LR-CS30	ST4x10	4
	DO-D14	1823	3		LR-CS31	M8x60	14
	DO-D14a	1823	3		LR-CS32	ST5.5x38	48
	DO-D16	1822	3		LR-CS33	M8x130	4
	AT-16	260	1		LR-CS34	ST4.8x38	40
	AT-16a	205	1		LR-CS35	ST4.2x19	72
	AT-B17	1412	8		LR-CS36	M6x20	4
	AT-17		4		LR-CS37	M8x20	12
	AT-10		4		LR-CS38	ST4x25	80
	DO-30		6				
	ATW-18		1				
	ATW-18a		1				
	ATL-14	1000	2				
	ATL-14a	420	4				

Part A.



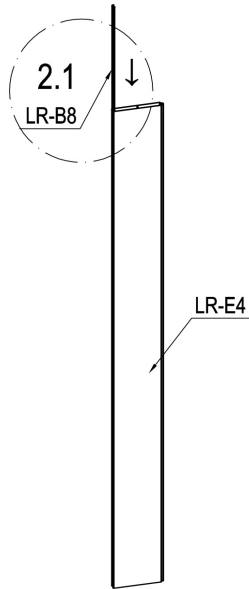

	LR-B2	1
	DO-C3c	2
	Dr-28	2
	LR-CS32	4

Part A.



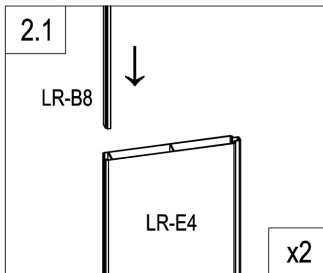

x2



	LR-B8	2
	LR-E4	2

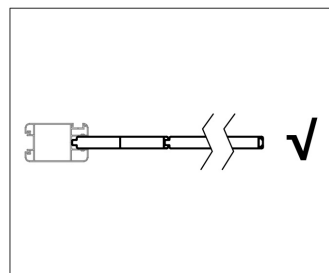
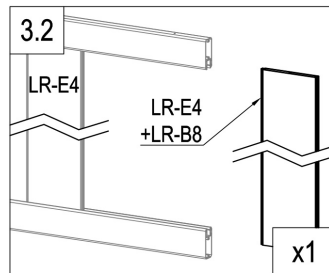
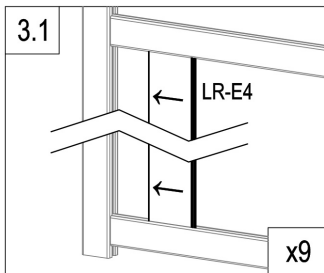
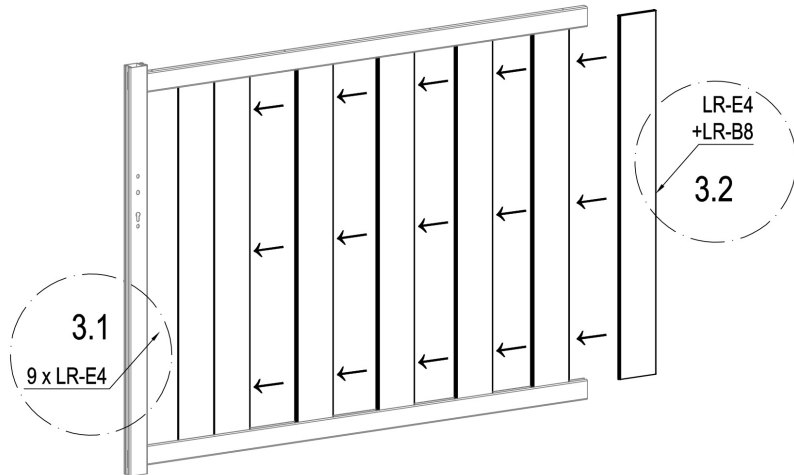

Part A.



	LR-E4	9
---	-------	---

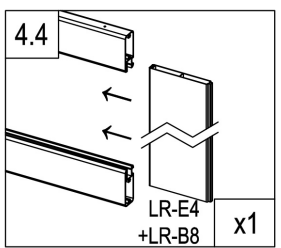
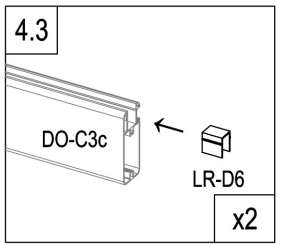
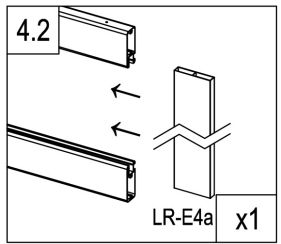
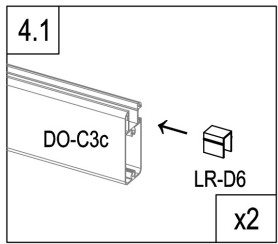
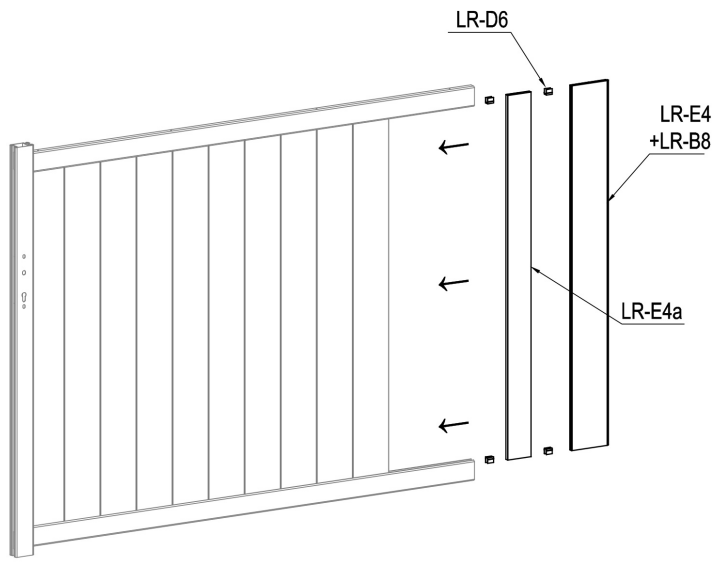

Part A.



	LR-E4a	1
	LR-D6	4

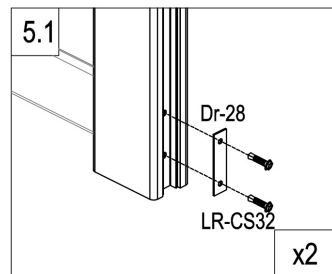
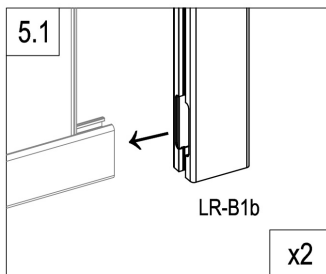
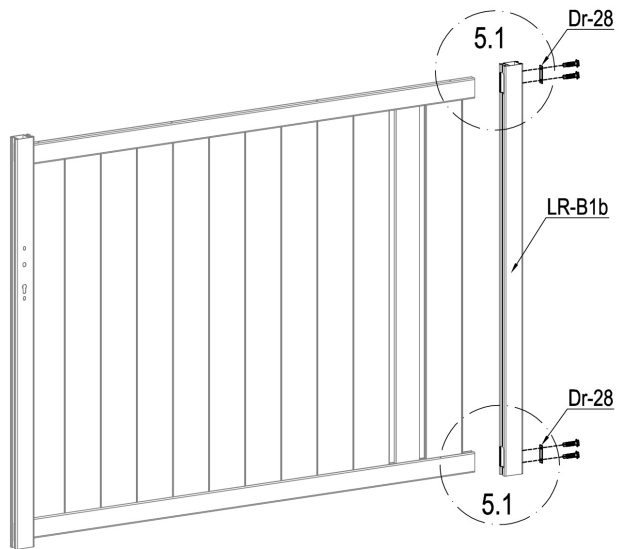

Part A.

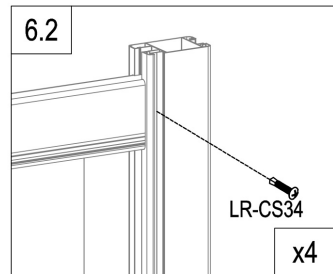
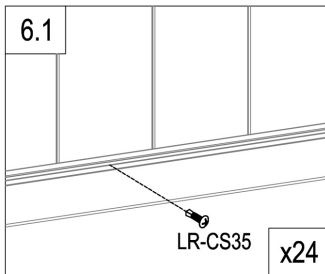
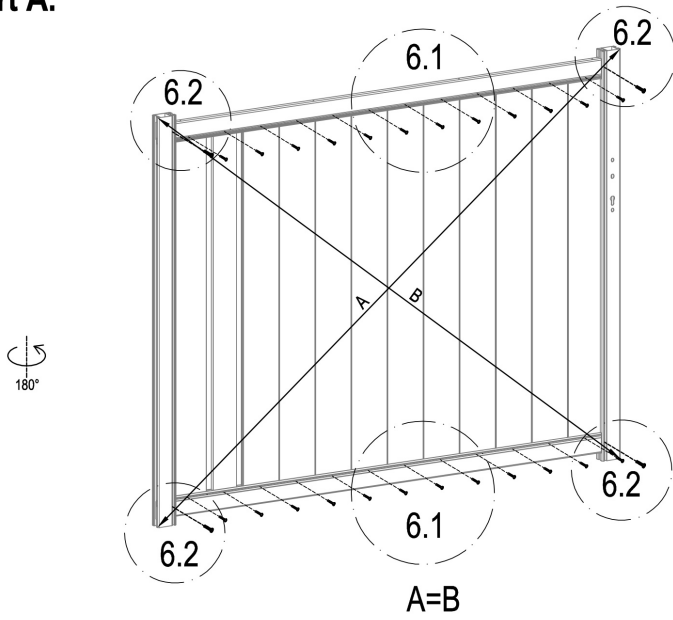

	LR-B1b	1
	Dr-28	2
	LR-CS32	4

Part A.



	LR-CS35	24
	LR-CS34	4

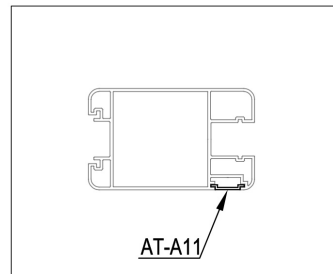
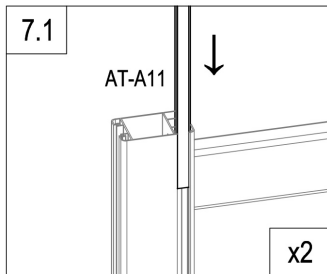
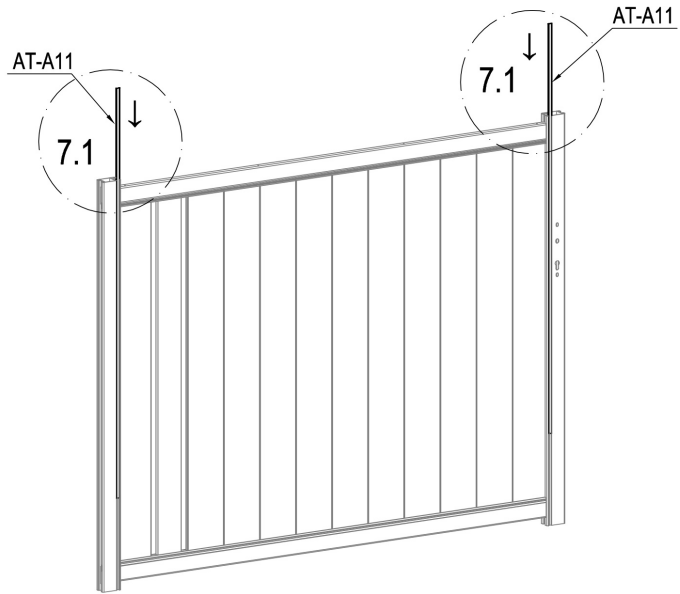

Part A.

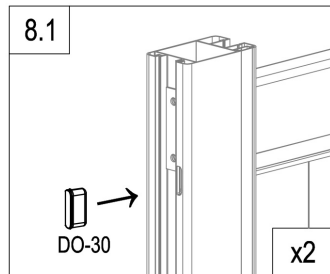
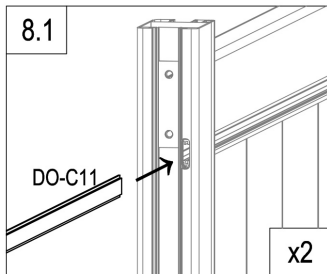
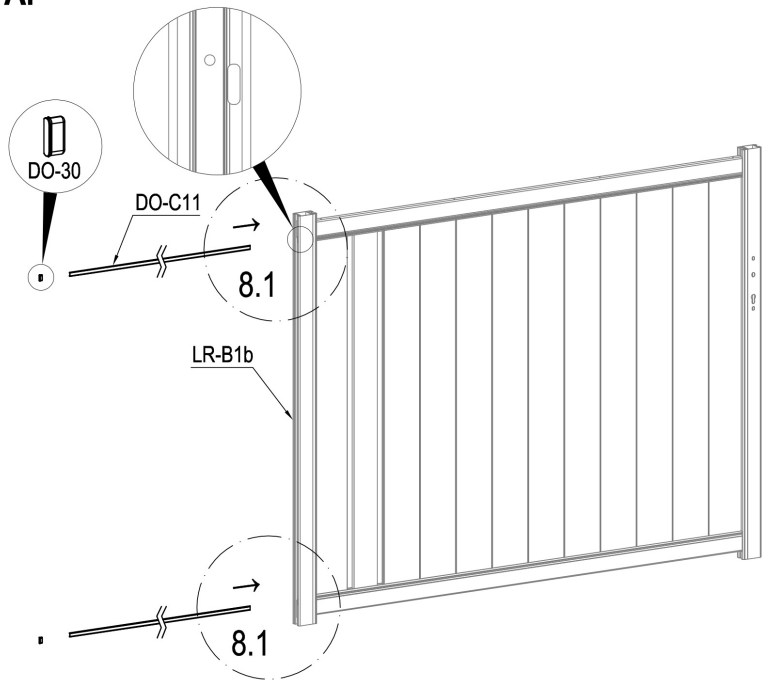

	AT-A11	2
---	--------	---

Part A.



	DO-C11	2
	DO-30	2

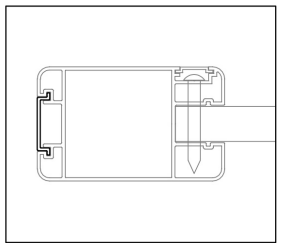
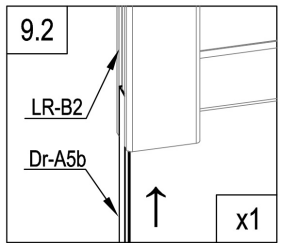
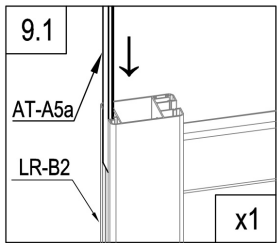
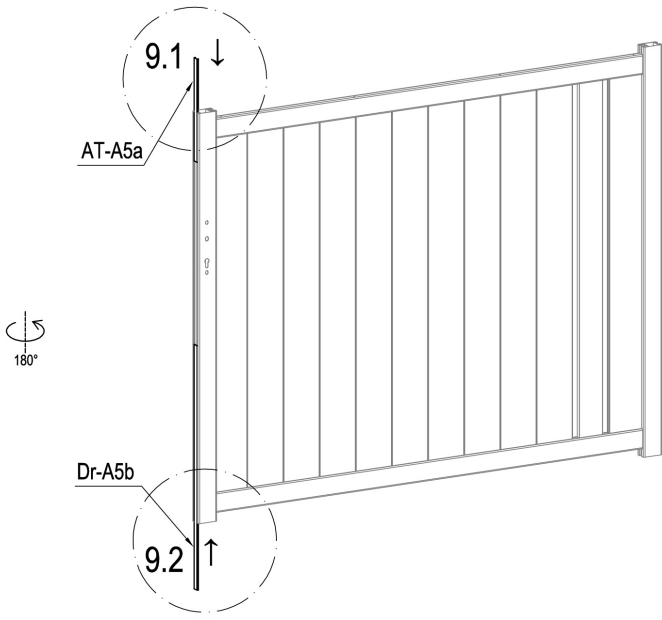

Part A.



	AT-A5a	1
	Dr-A5b	1

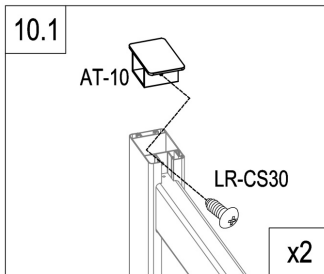
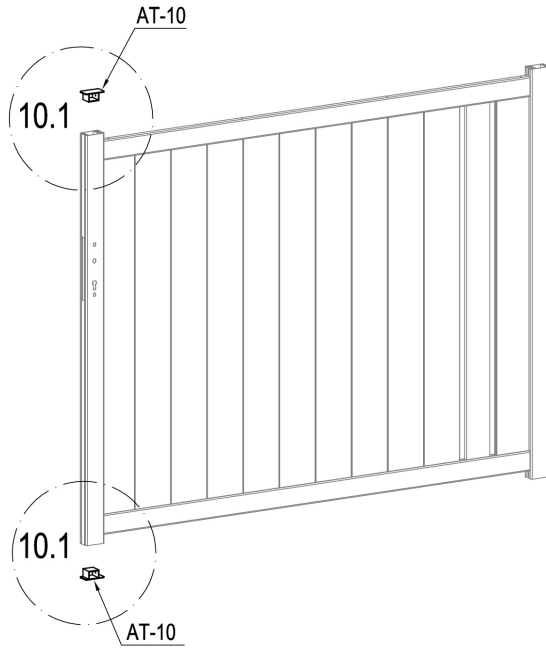



Part A.

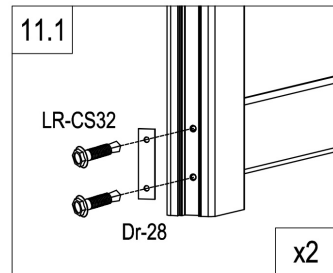
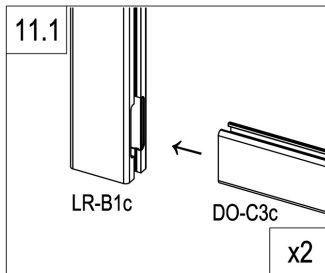
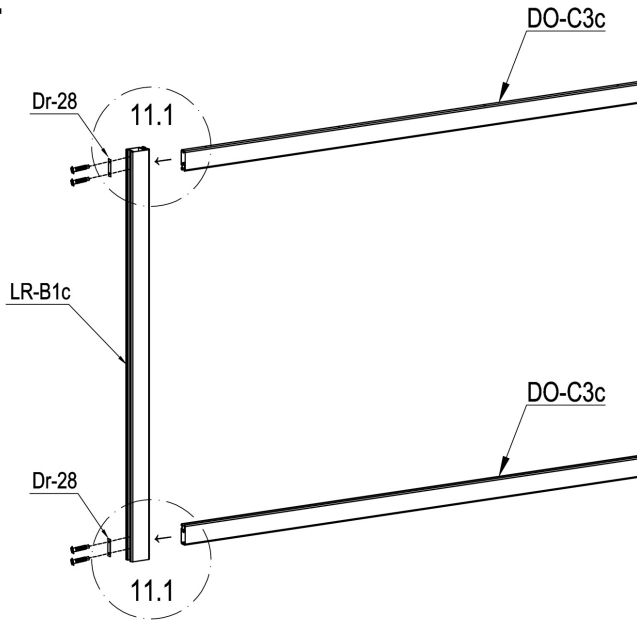

	AT-10	2
	LR-CS30	2



Part B.



	LR-B1c	1
	DO-C3c	2
	Dr-28	2
	LR-CS32	4

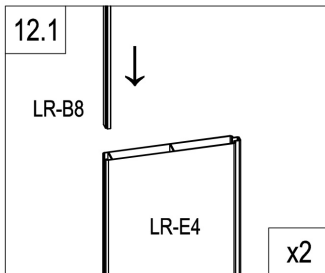
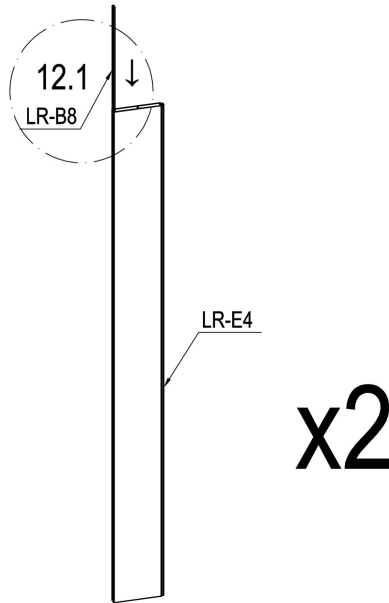

Part B.

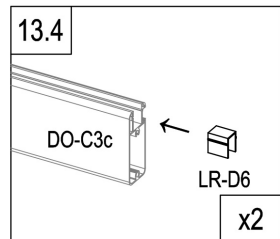
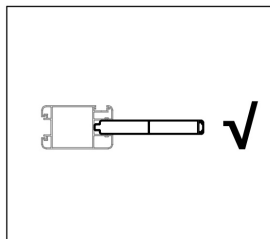
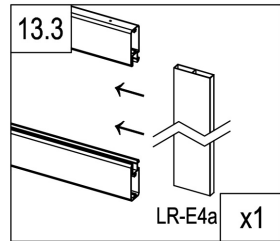
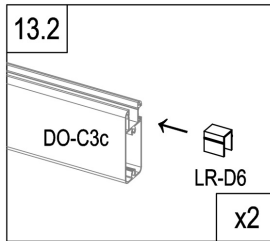
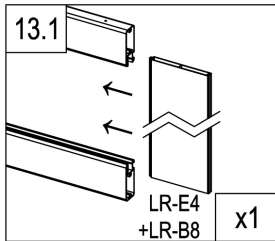
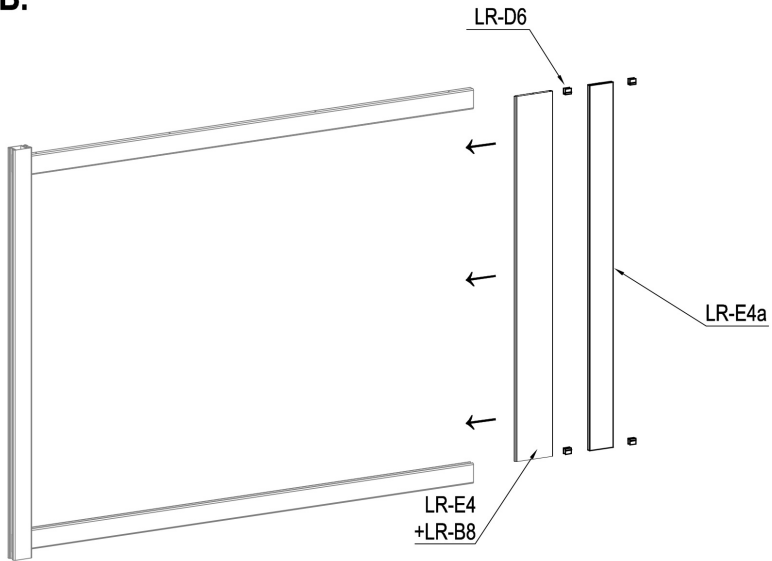

	LR-B8	2
	LR-E4	2

Part B.



	LR-E4a	1
	LR-D6	4

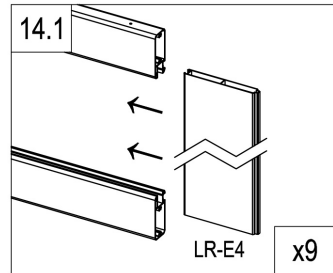
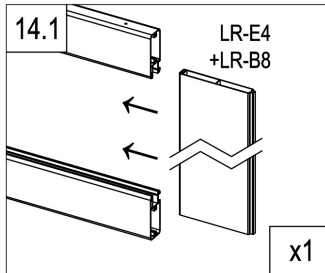
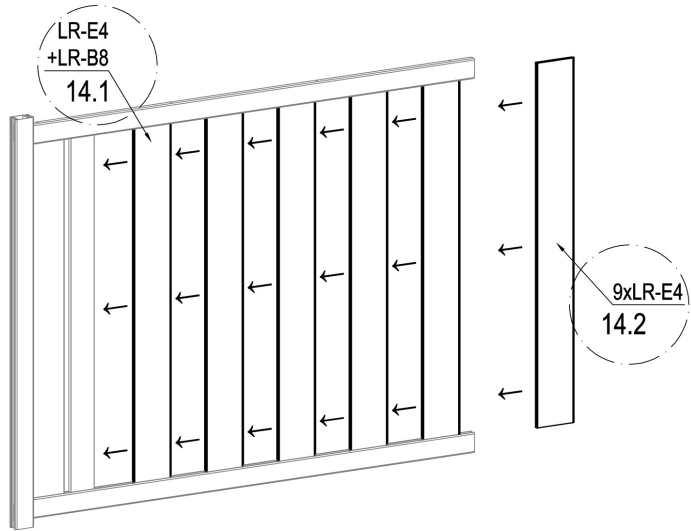

Part B.



	LR-E4	9
---	-------	---

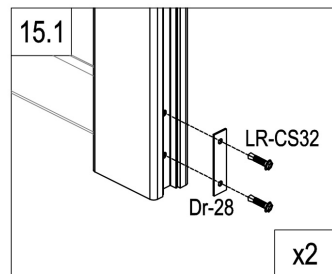
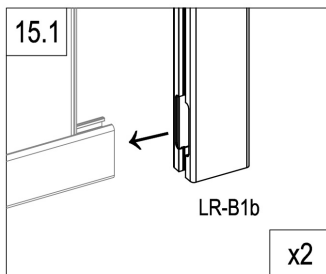
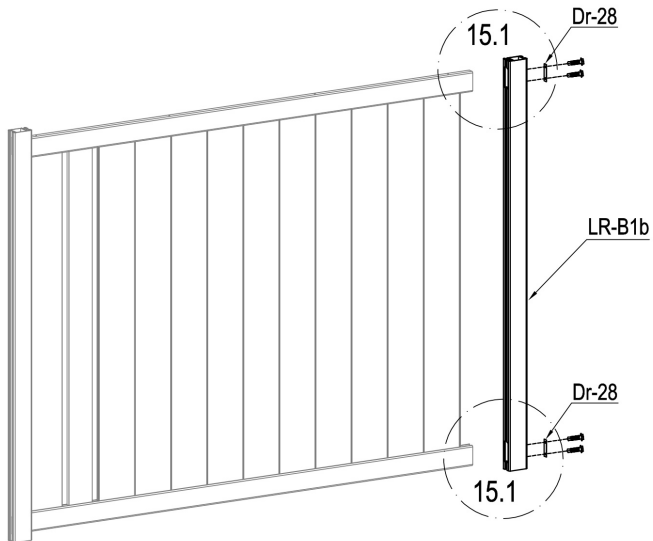

Part B.

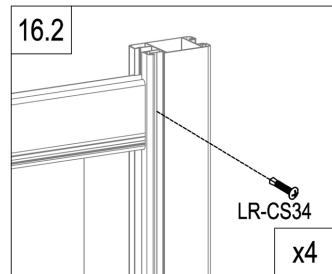
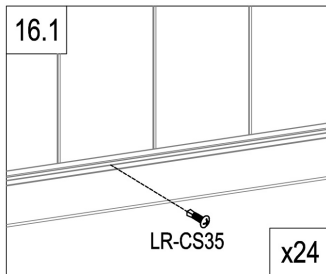
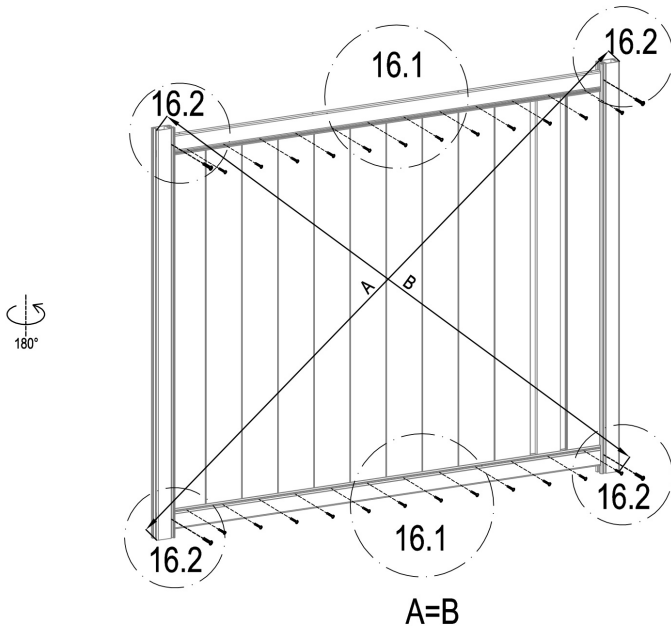

	LR-B1b	1
	Dr-28	2
	LR-CS32	4

Part B.



	LR-CS35	24
	LR-CS34	4

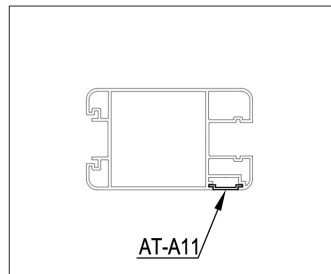
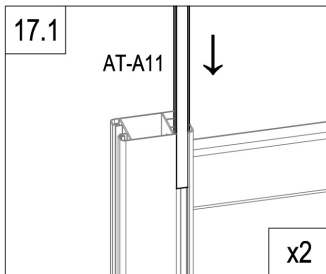
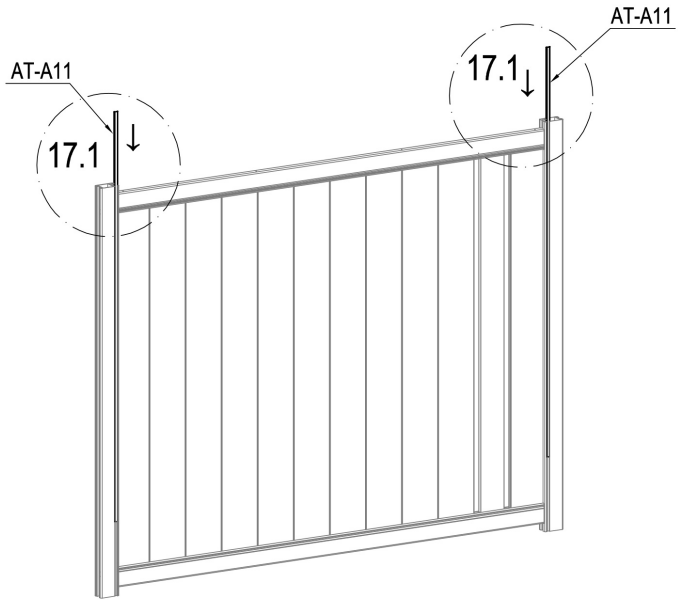

Part B.



	AT-A11	2
---	--------	---

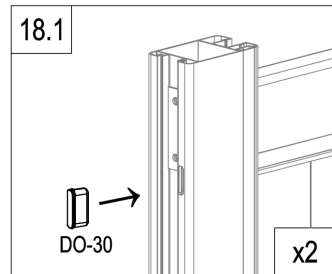
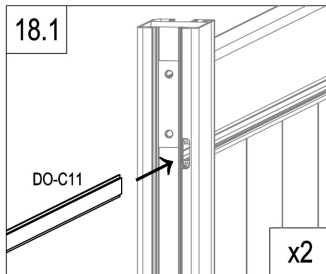
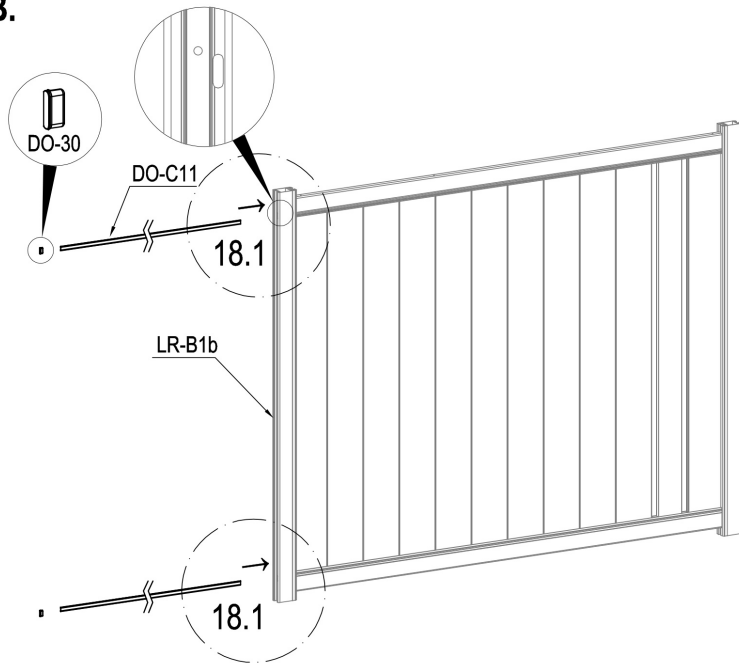



Part B.

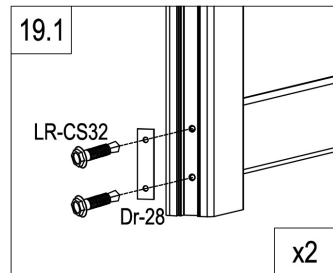
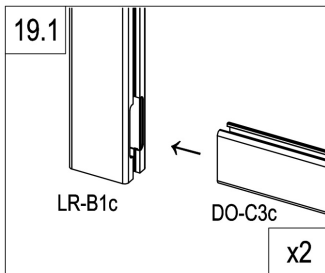
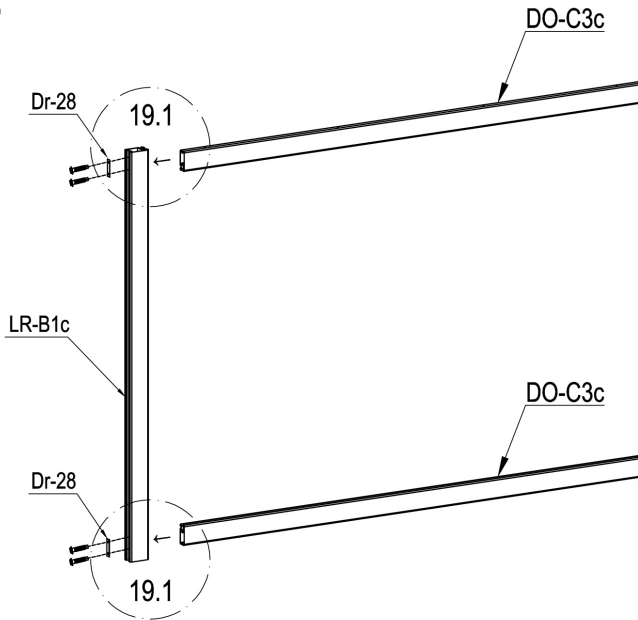

	DO-C11	2
	DO-30	2



Part C.



	LR-B1c	1
	DO-C3c	2
	Dr-28	2
	LR-CS32	4

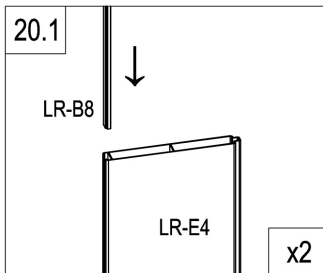
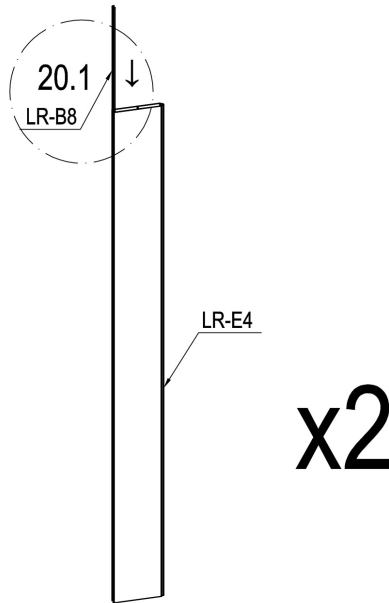

Part C.

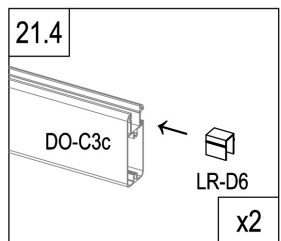
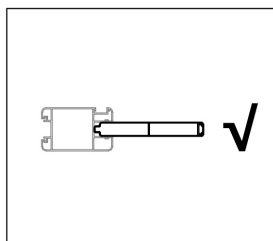
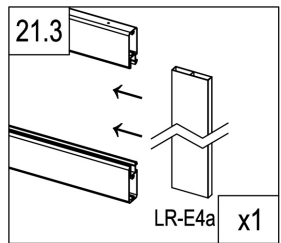
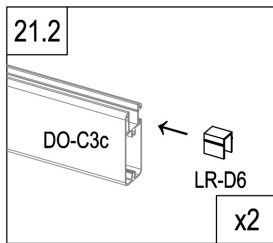
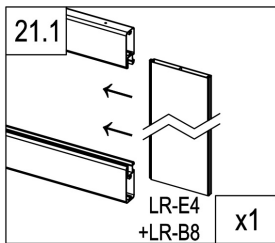
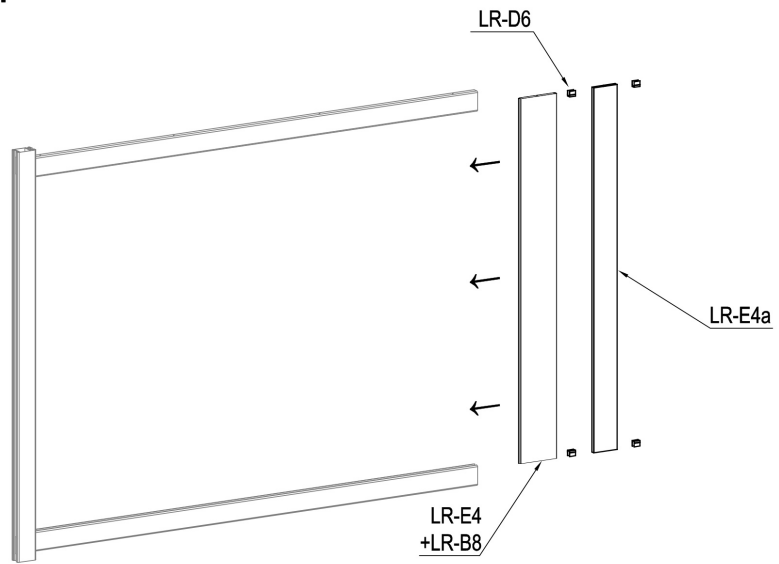

	LR-B8	2
	LR-E4	2

Part C.



	LR-E4a	1
	LR-D6	4

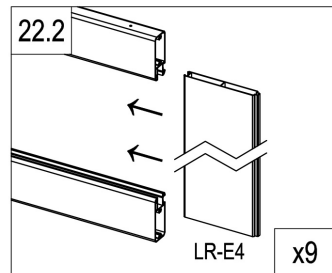
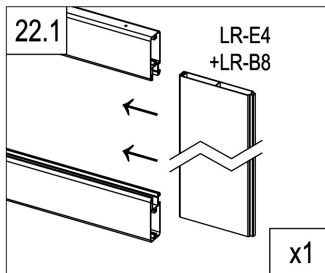
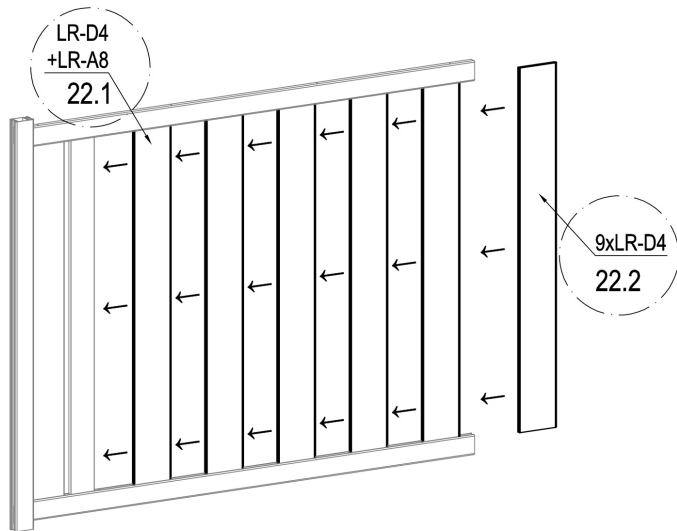

Part C.



	LR-E4	9
---	-------	---

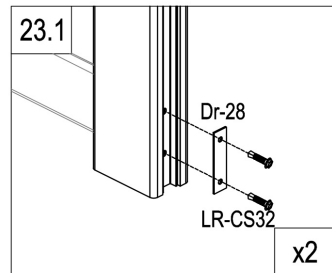
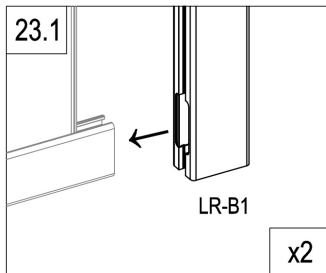
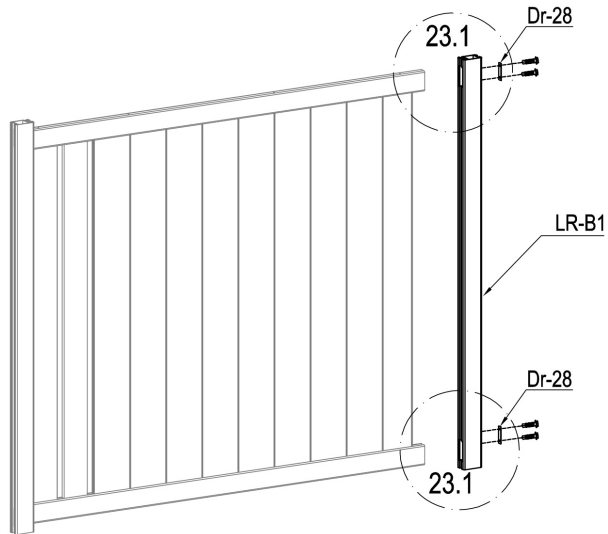

Part C.

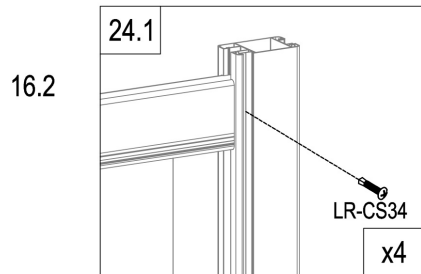
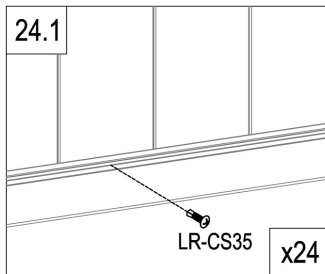
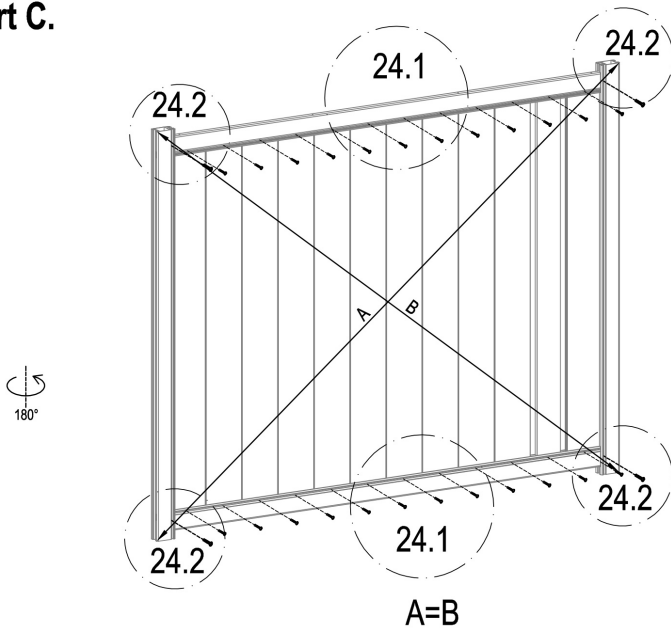

	LR-B1	1
	Dr-28	2
	LR-CS32	4

Part C.



	LR-CS35	24
	LR-CS34	4

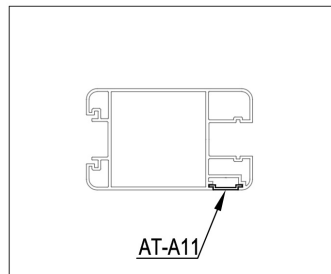
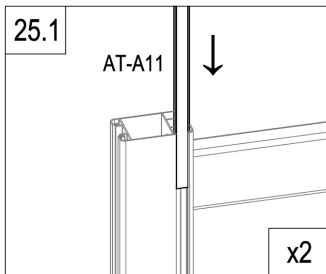
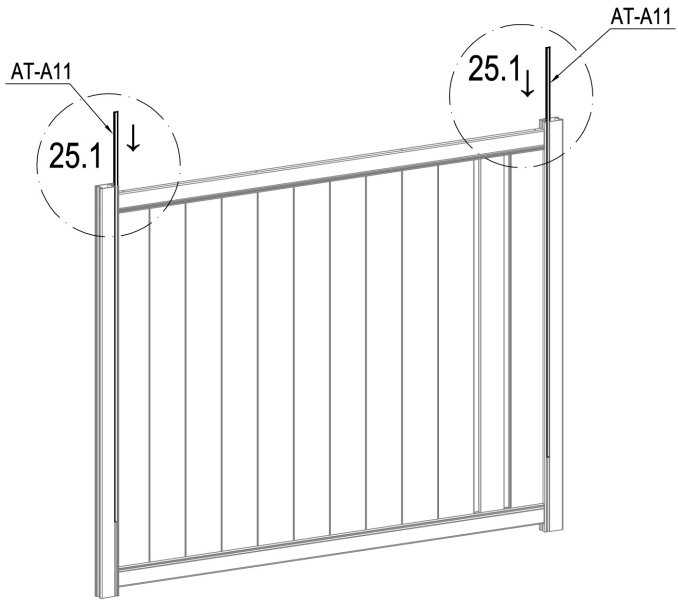

Part C.

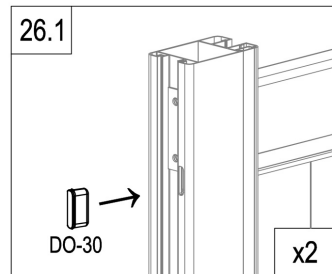
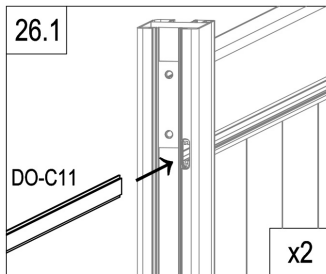
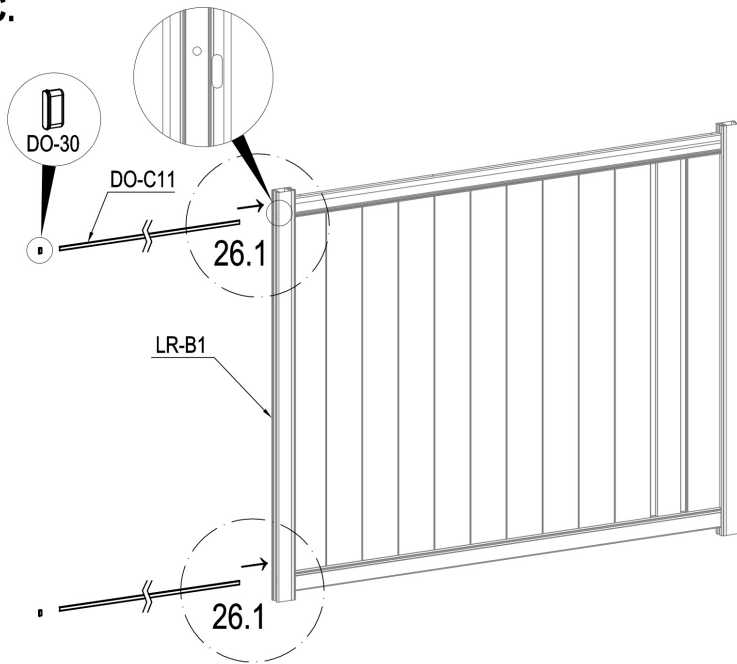

	AT-A11	2
---	--------	---

Part C.



	DO-C11	2
	DO-30	2

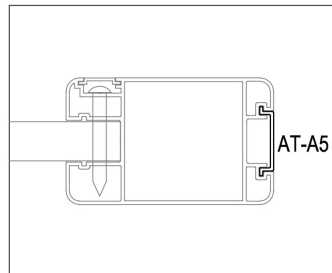
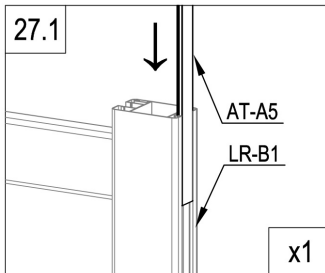
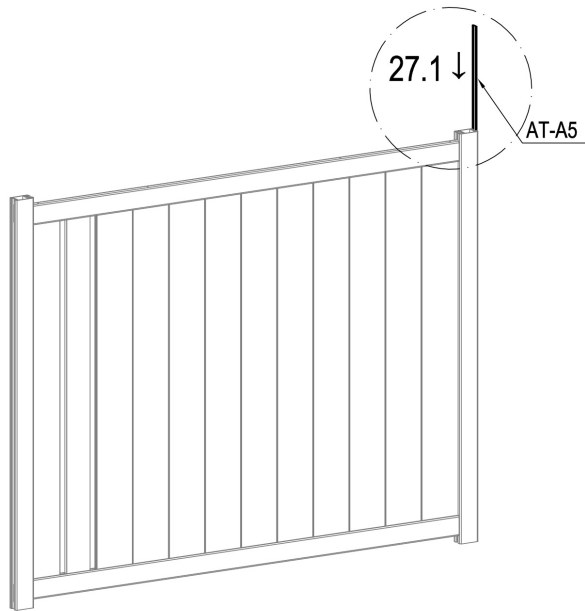

Part C.





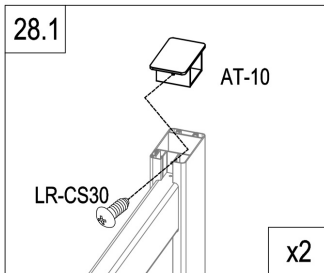
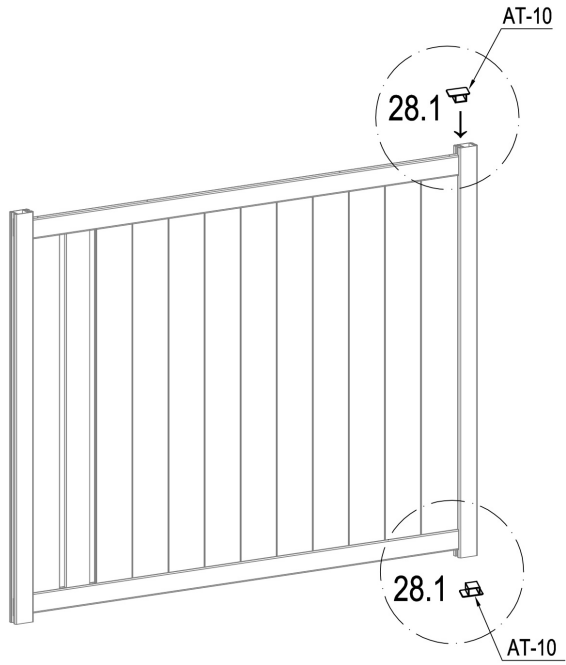

]	AT-A5	1
---	-------	---

Part C.

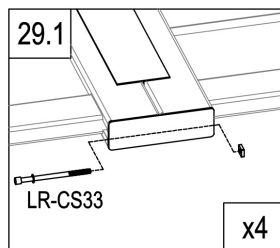
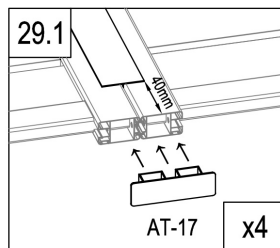
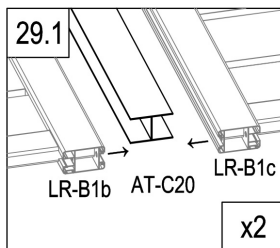
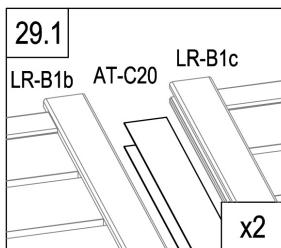
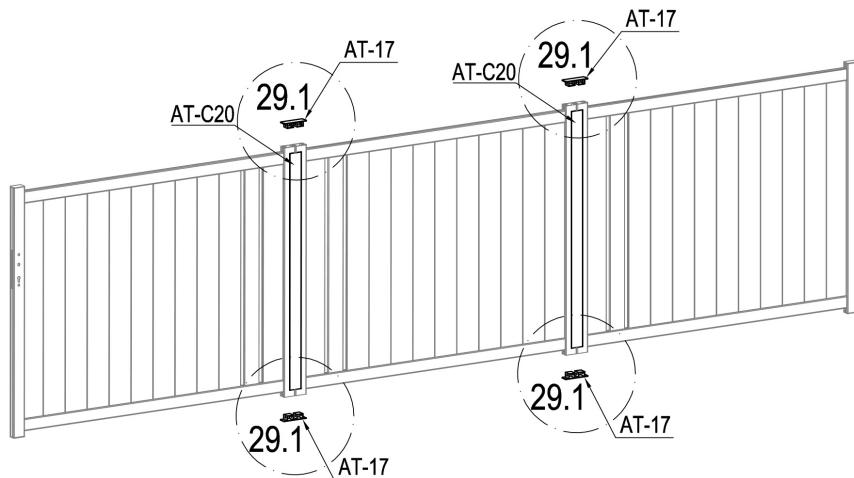



	AT-10	2
	LR-CS30	2

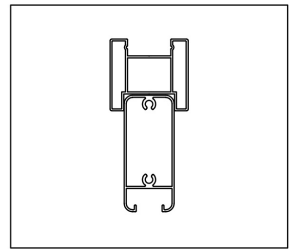
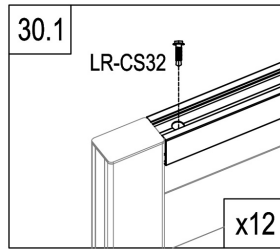
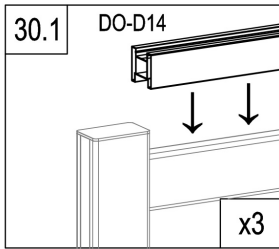
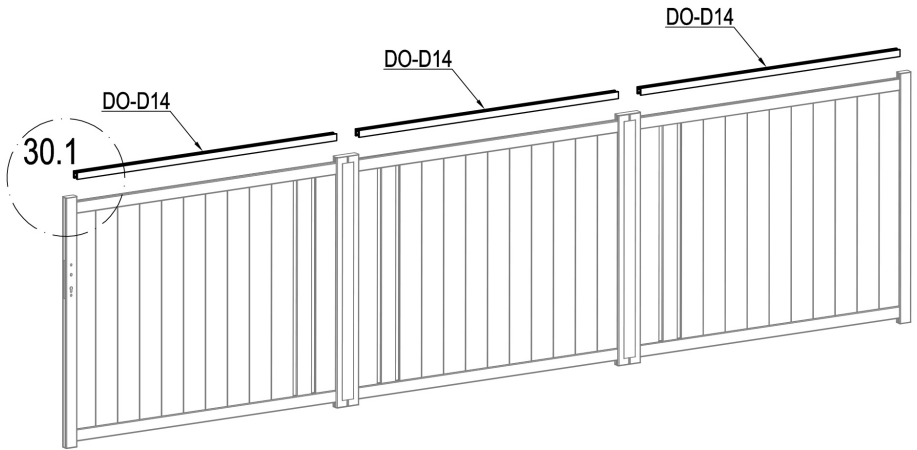

	AT-C20	2
	AT-17	4
	LR-CS33	4



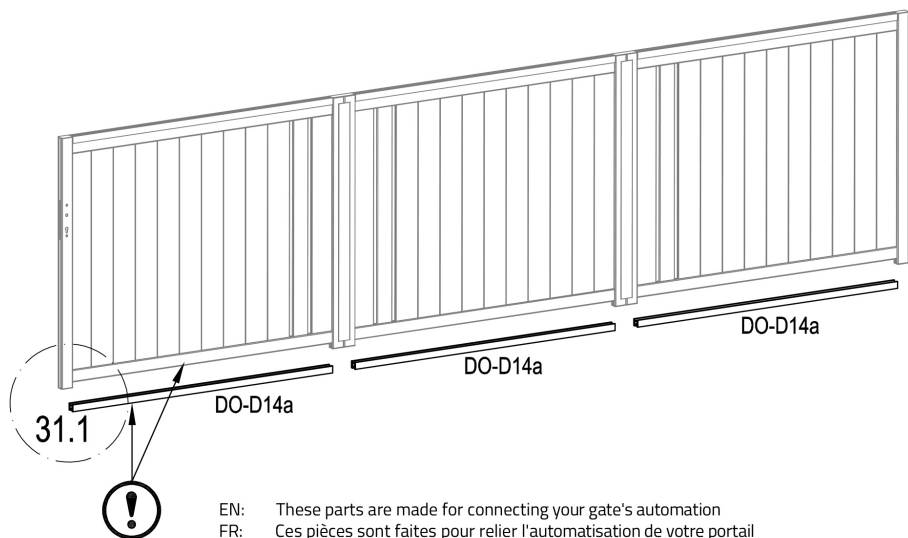

	DO-D14	3
	LR-CS32	12



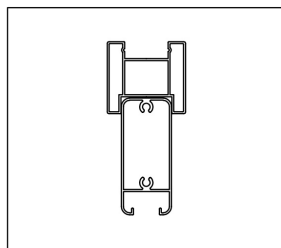
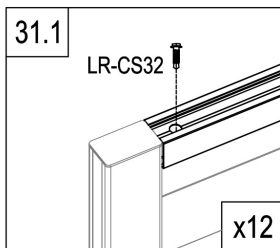
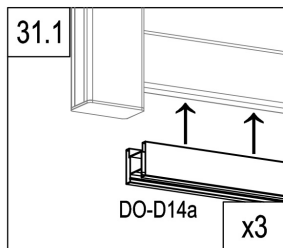

EN: These parts are made for connecting your gate's automation
 FR: Ces pièces sont faites pour relier l'automatisation de votre portail
 DE: Diese Teile sind für den Anschluss der Automatisierung Ihres Tores vorgesehen
 ES: Estas piezas están hechas para conectar la automatización de su puerta
 PT: Estas peças são feitas para ligar a automatização do seu portão
 IT: Queste parti sono realizzate per collegare l'automazione del vostro cancello
 NL: Deze onderdelen zijn gemaakt voor het aansluiten van de automatisering van uw poort.
 PL: Te części są wykonane do podłączenia automatyki bramy.



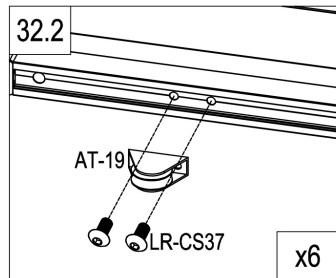
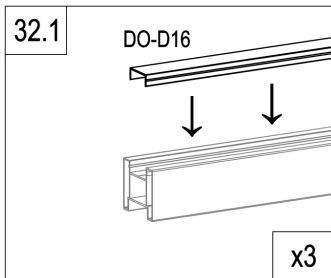
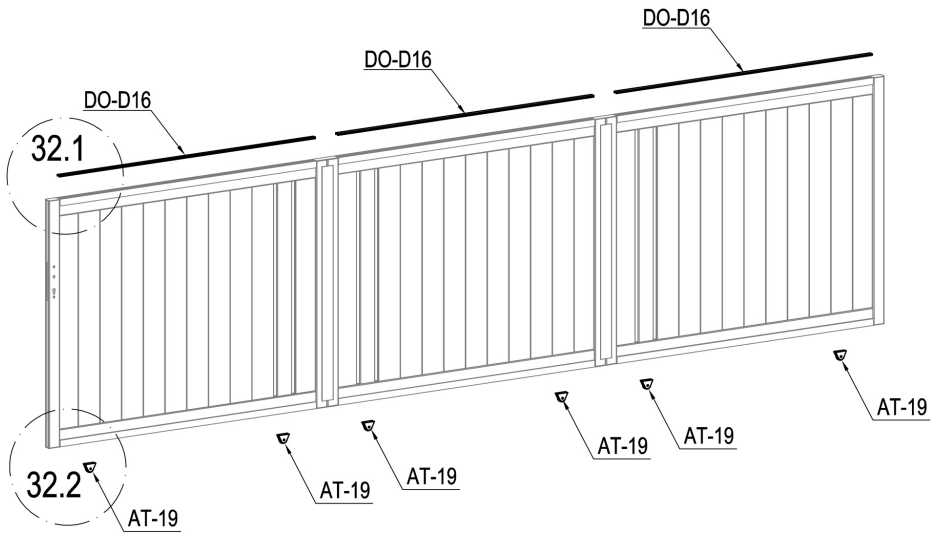

	DO-D14a	3
	LR-CS32	12

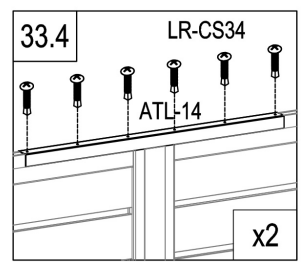
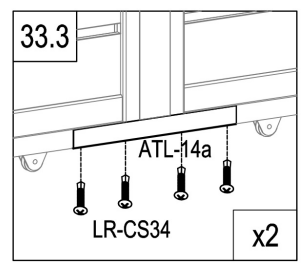
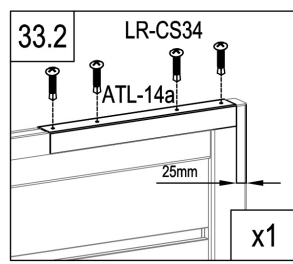
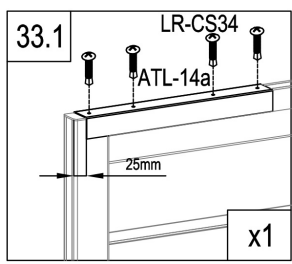
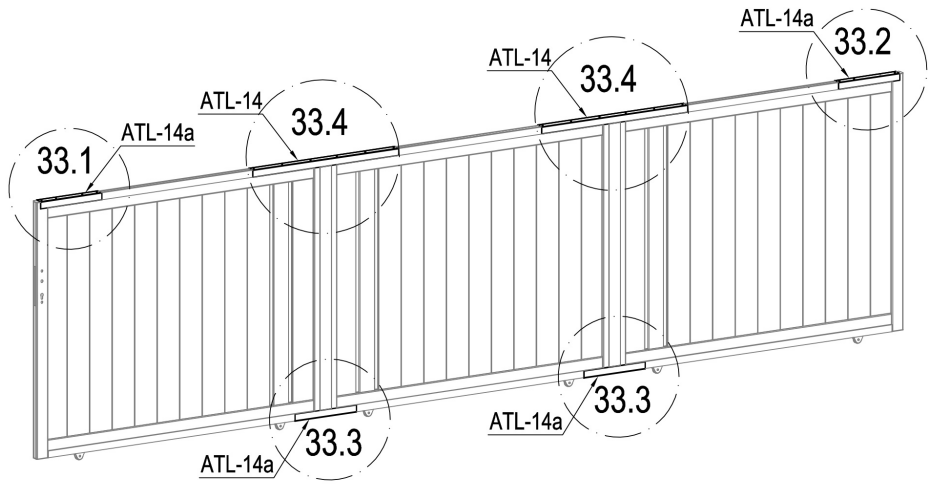

	DO-D16	3
	AT-19	6
	LR-CS37	12



	ATL-14	2
	ATL-14a	4
	LR-CS34	28

Ext.

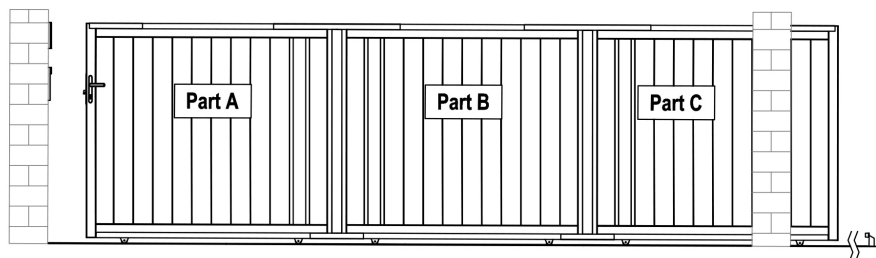

Int.

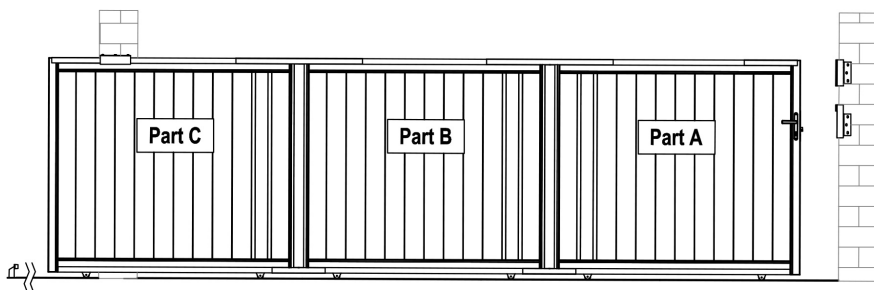

Ext.

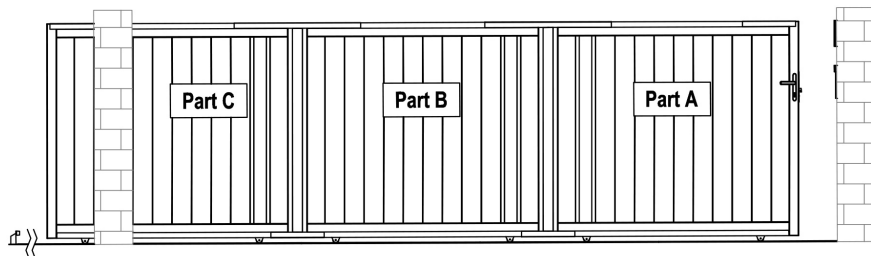

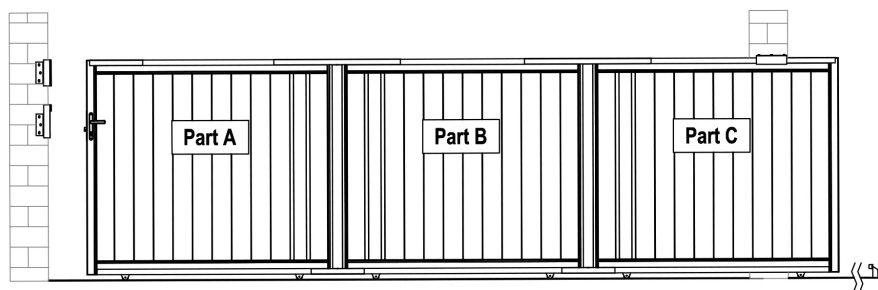

Int.

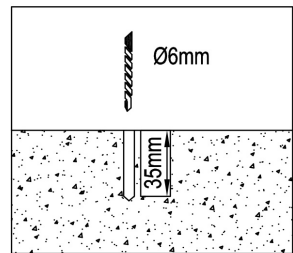
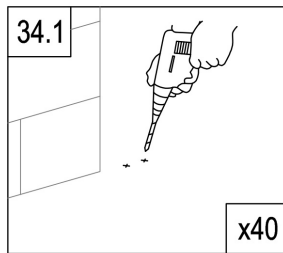
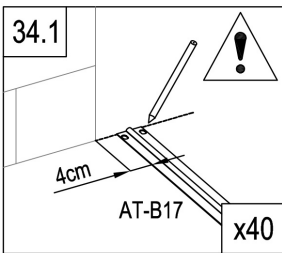
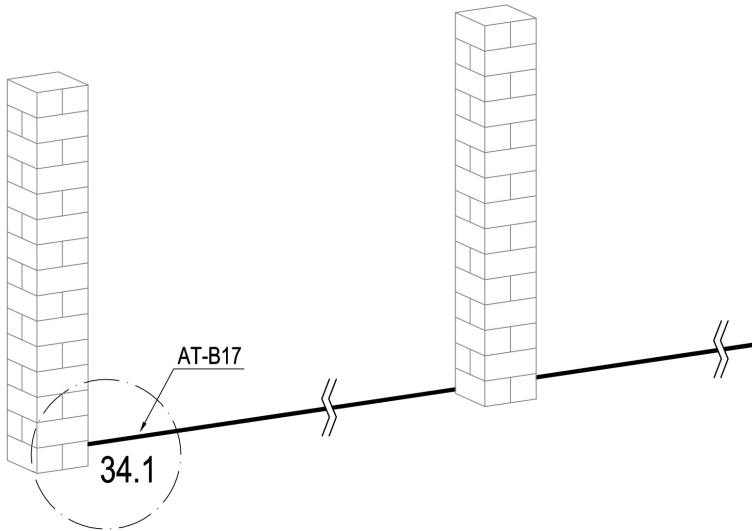

R

L



	AT-B17	8
	LR-CS38	80

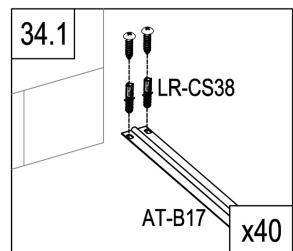

L

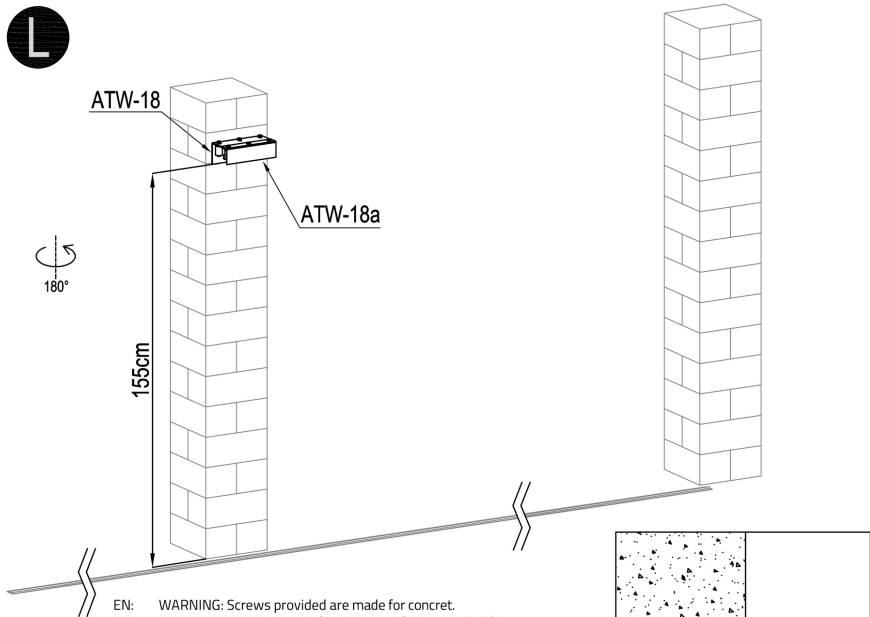

EN: WARNING: Screws provided are made for concrete.
 FR: AVERTISSEMENT : Les vis fournies sont faites pour le béton.
 DE: WARNUNG: Die mitgelieferten Schrauben sind für Beton ausgelegt.
 ES: ADVERTENCIA: Los tornillos suministrados están hechos para el hormigón.
 IT: ATTENZIONE: Le viti fornite sono fatte per il calcestruzzo.
 NL: WAARSCHUWING: De bijgeleverde schroeven zijn gemaakt voor beton.
 PL: OSTRZEŻENIE: Dostarczone śruby są przeznaczone do betonu.
 PT: AVISO: Os parafusos fornecidos são feitos para betão.

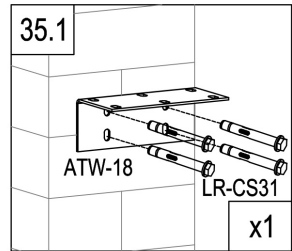
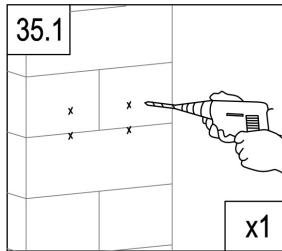
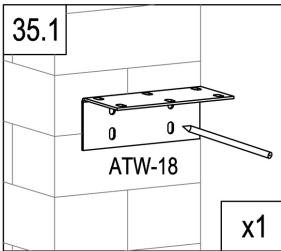
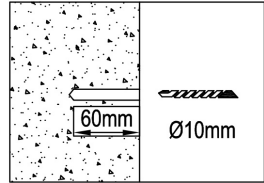

	ATW-18	1
	ATW-18a	1
	AT-20	6
	LR-CS31	4

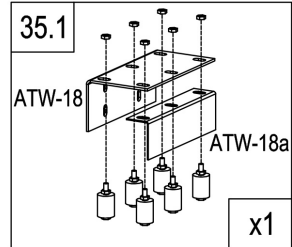
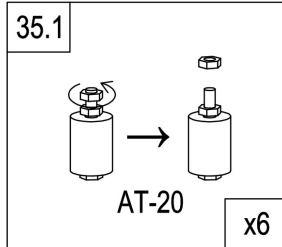

L

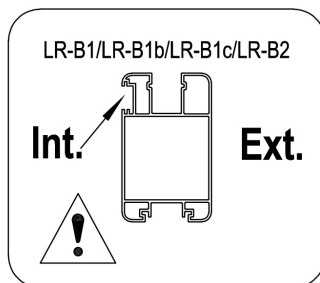
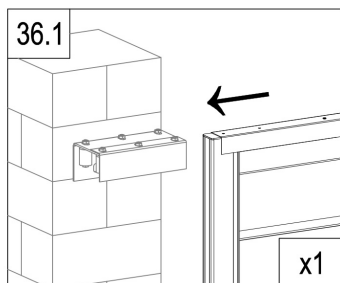
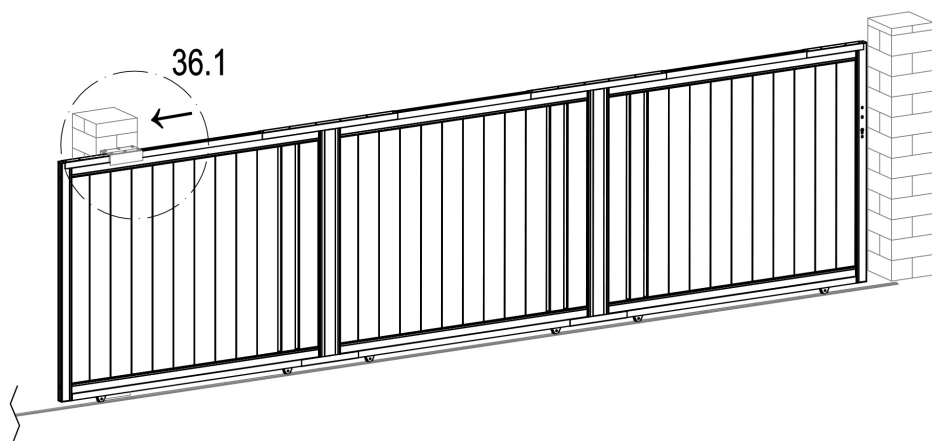

L

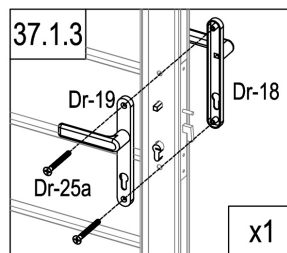
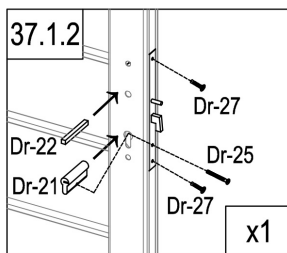
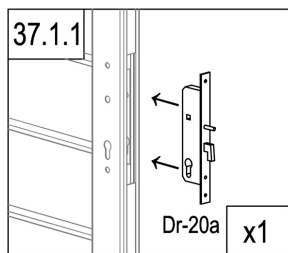
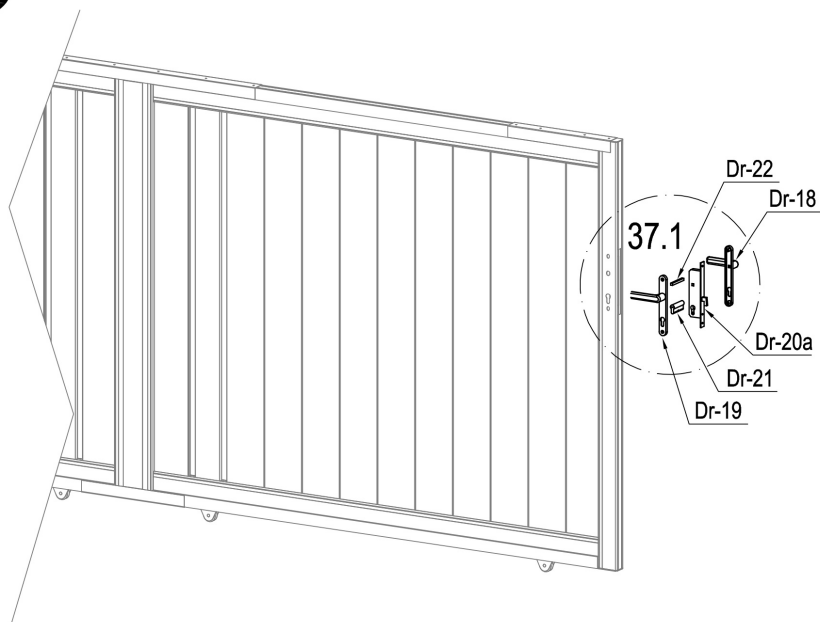

	Dr-20a	1
	Dr-21	1
	Dr-22	1
	Dr-25	1

	Dr-18	1
	Dr-19	1
	Dr-25a	2
	Dr-27	2



EN: WARNING: Screws provided are made for concrete.
 FR: AVERTISSEMENT : Les vis fournies sont faites pour le béton.
 DE: WARNUNG: Die mitgelieferten Schrauben sind für Beton ausgelegt.
 ES: ADVERTENCIA: Los tornillos suministrados están hechos para el hormigón.
 IT: ATTENZIONE: Le viti fornite sono fatte per il calcestruzzo.
 NL: WAARSCHUWING: De bijgeleverde schroeven zijn gemaakt voor beton.
 PL: OSTRZEZENIE: Dostarczone śruby są przeznaczone do betonu.
 PT: AVISO: Os parafusos fornecidos são feitos para betão.

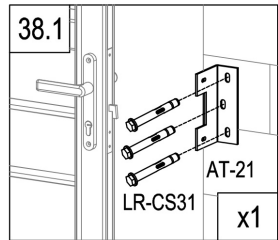
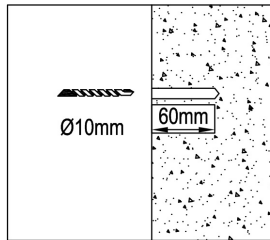
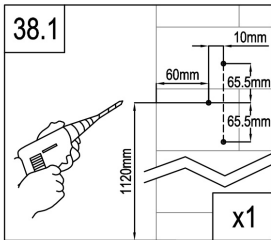
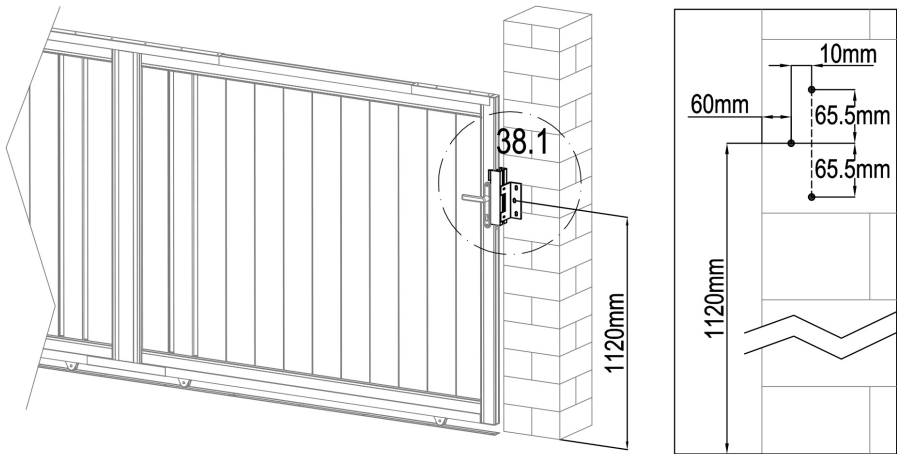

	AT-16	1
	AT-21	1
	LR-CS36	2
	LR-CS31	3
	AT-22J	3

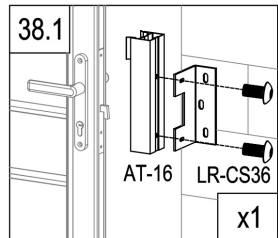
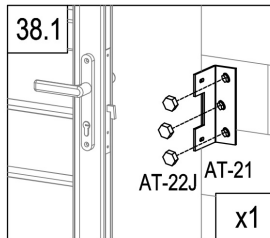

L

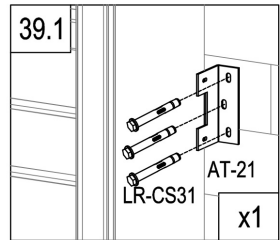
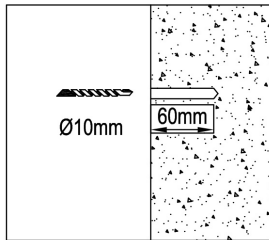
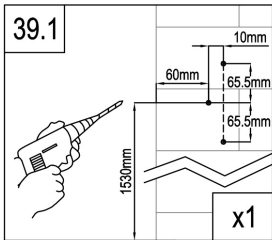
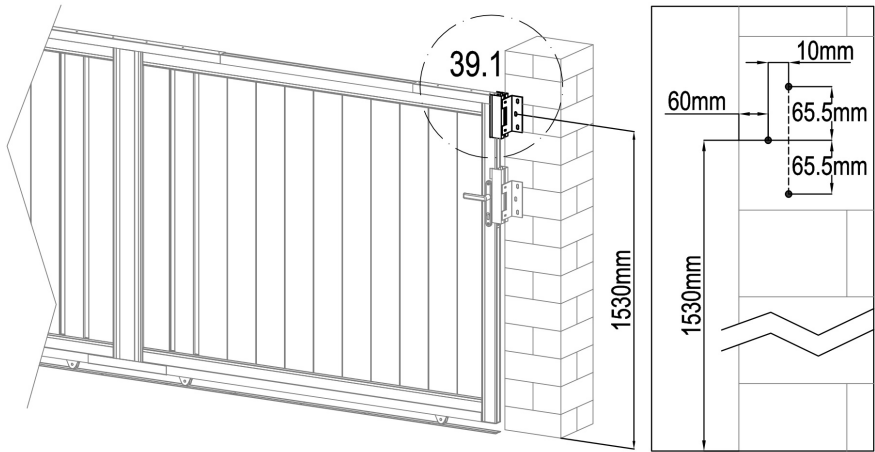

	AT-16a	1
	AT-21	1
	LR-CS36	2
	LR-CS31	3
	AT-22J	3

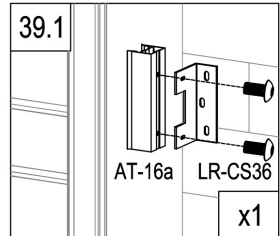
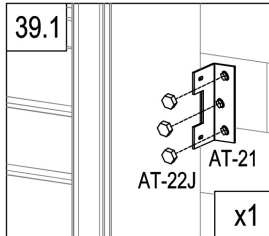

L

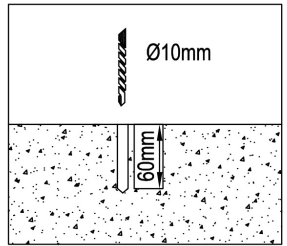
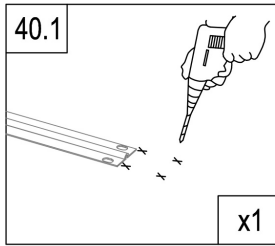
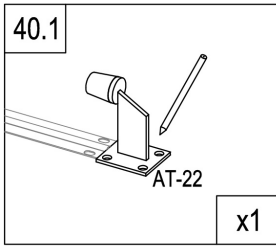
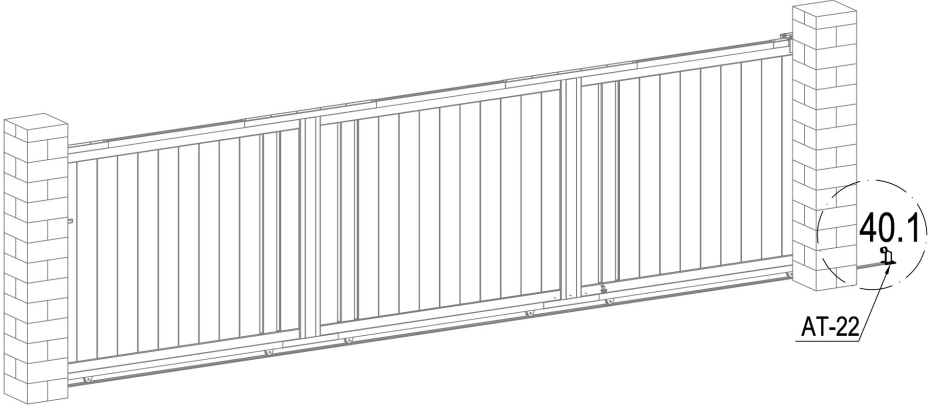

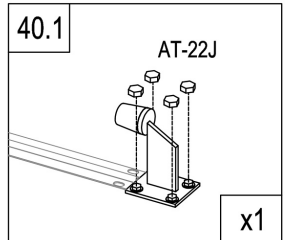
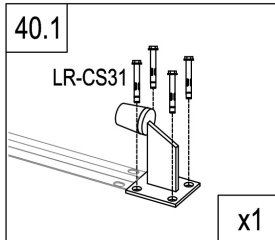

	AT-22	1
	LR-CS31	4
	AT-22J	4

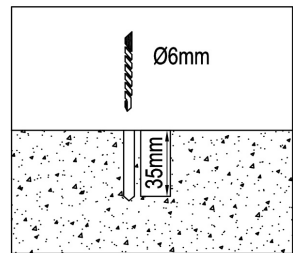
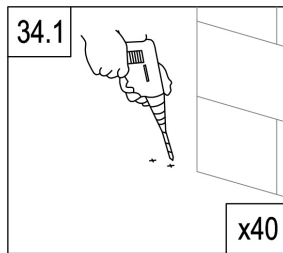
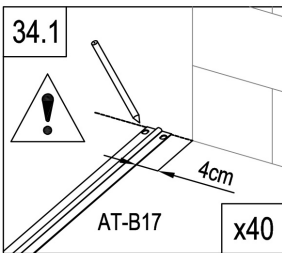
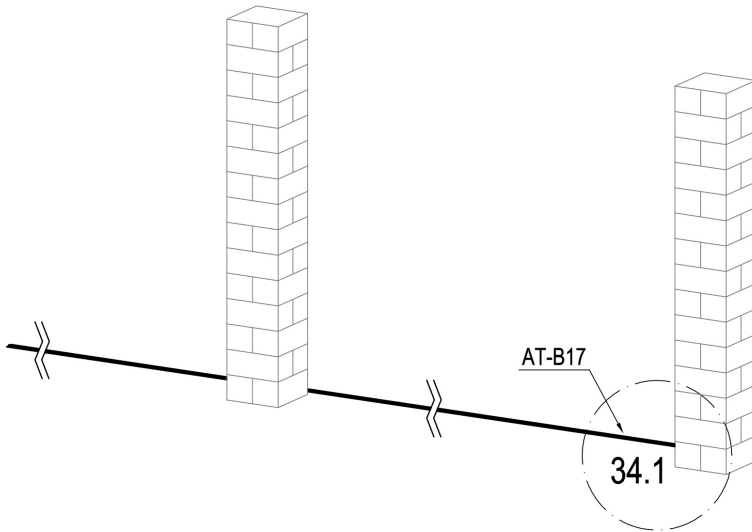

R



	AT-B17	8
	LR-CS38	80

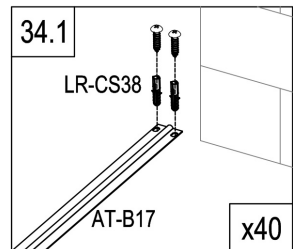

R

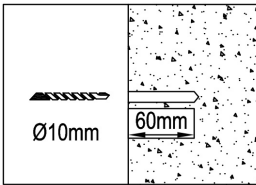
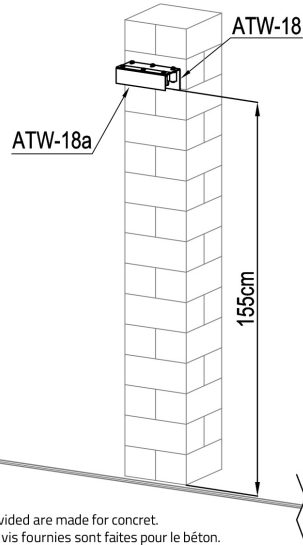

EN: WARNING: Screws provided are made for concrete.
 FR: AVERTISSEMENT : Les vis fournies sont faites pour le béton.
 DE: WARNUNG: Die mitgelieferten Schrauben sind für Beton ausgelegt.
 ES: ADVERTENCIA: Los tornillos suministrados están hechos para el hormigón.
 IT: ATTENZIONE: Le viti fornite sono fatte per il calcestruzzo.
 NL: WAARSCHUWING: De bijgeleverde schroeven zijn gemaakt voor beton.
 PL: OSTRZEŻENIE: Dostarczone śruby są przeznaczone do betonu.
 PT: AVISO: Os parafusos fornecidos são feitos para betão.

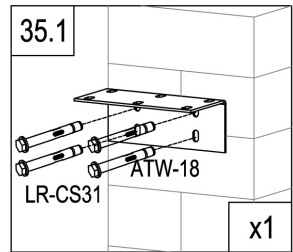
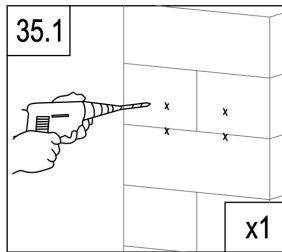
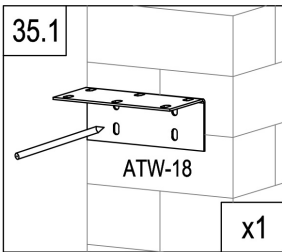

	ATW-18	1
	ATW-18a	1
	AT-20	6
	LR-CS31	4

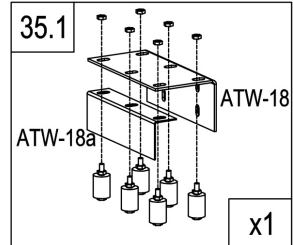
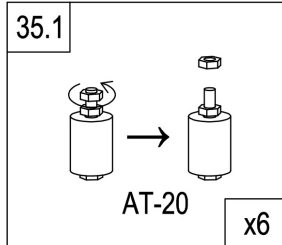

R

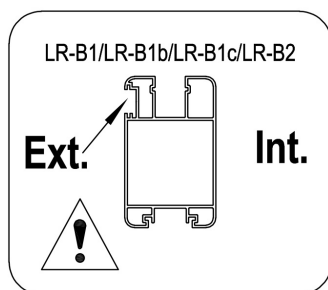
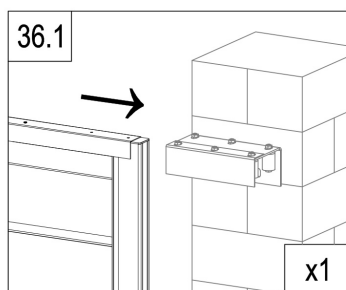
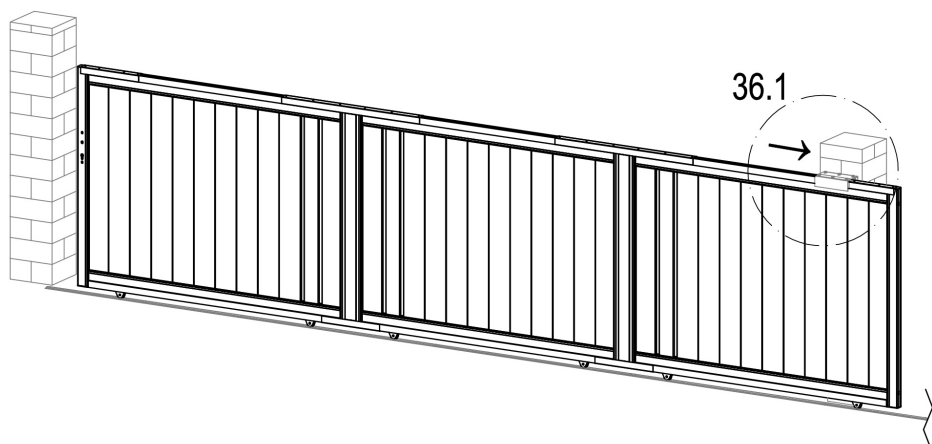

R

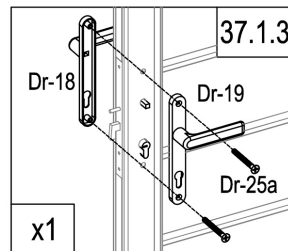
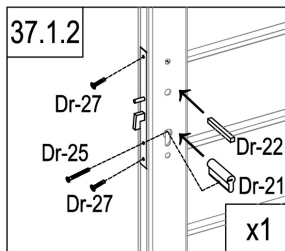
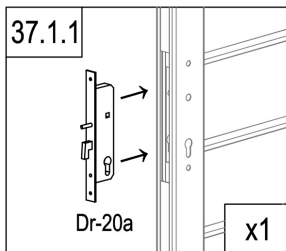
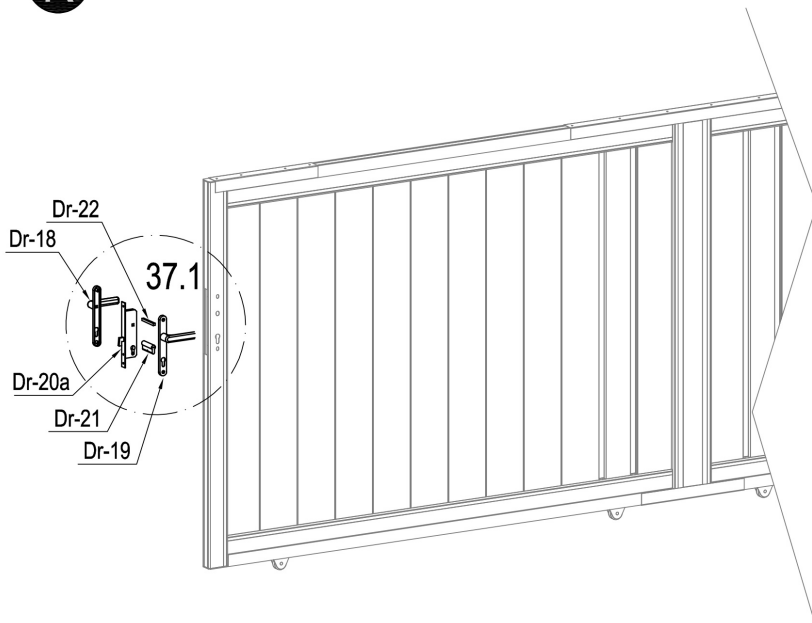

	Dr-20a	1
	Dr-21	1
	Dr-22	1
	Dr-25	1

	Dr-18	1
	Dr-19	1
	Dr-25a	2
	Dr-27	2



EN: WARNING: Screws provided are made for concret.
 FR: AVERTISSEMENT : Les vis fournies sont faites pour le béton.
 DE: WARNUNG: Die mitgelieferten Schrauben sind für Beton ausgelegt.
 ES: ADVERTENCIA: Los tornillos suministrados están hechos para el hormigón.
 IT: ATTENZIONE: Le viti fornite sono fatte per il calcestruzzo.
 NL: WAARSCHUWING: De bijgeleverde schroeven zijn gemaakt voor beton.
 PL: OSTRZEŻENIE: Dostarczone śruby są przeznaczone do betonu.
 PT: AVISO: Os parafusos fornecidos são feitos para betão.

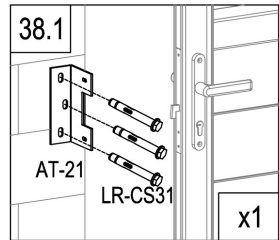
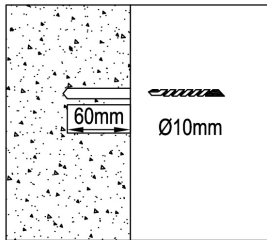
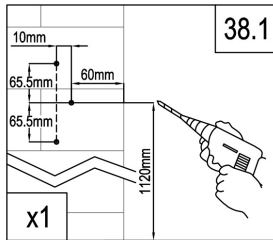
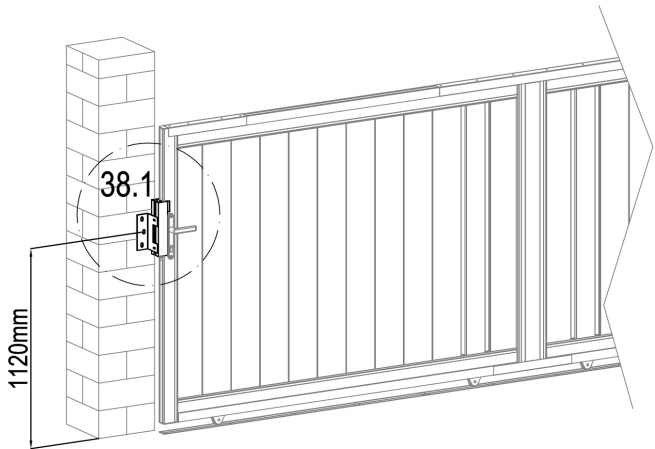
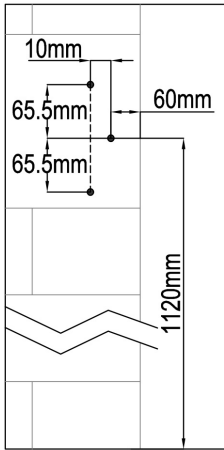

	AT-16	1
	AT-21	1
	LR-CS36	2
	LR-CS31	3
	AT-22J	3

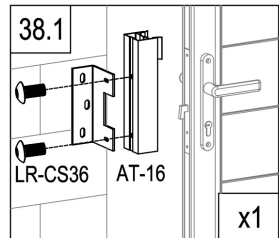
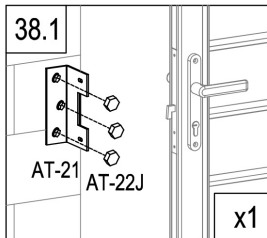

R

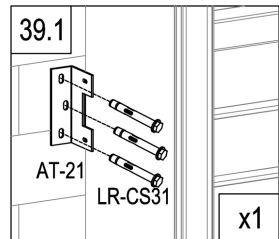
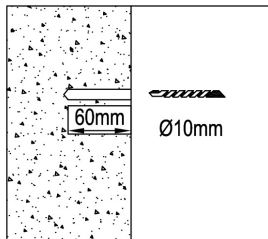
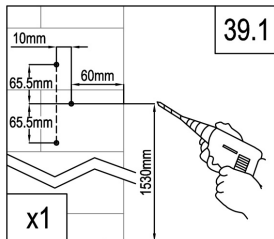
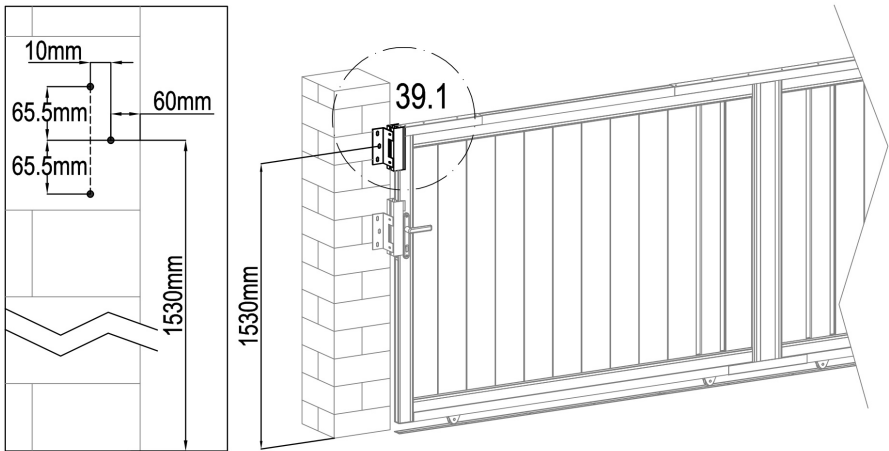

	AT-16a	1
	AT-21	1
	LR-CS36	2
	LR-CS31	3
	AT-22J	3

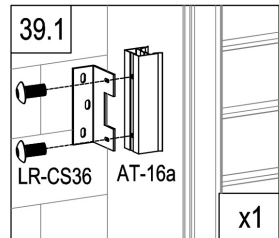
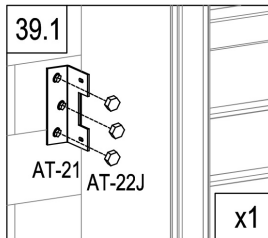

R

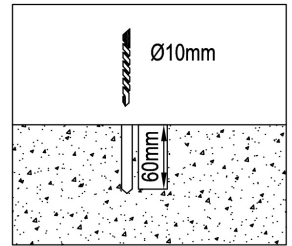
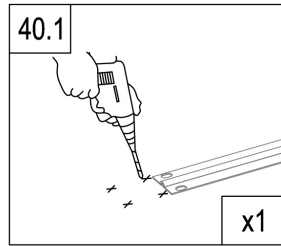
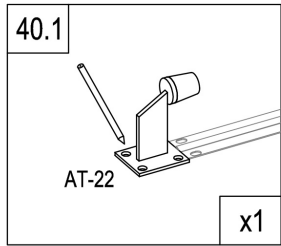
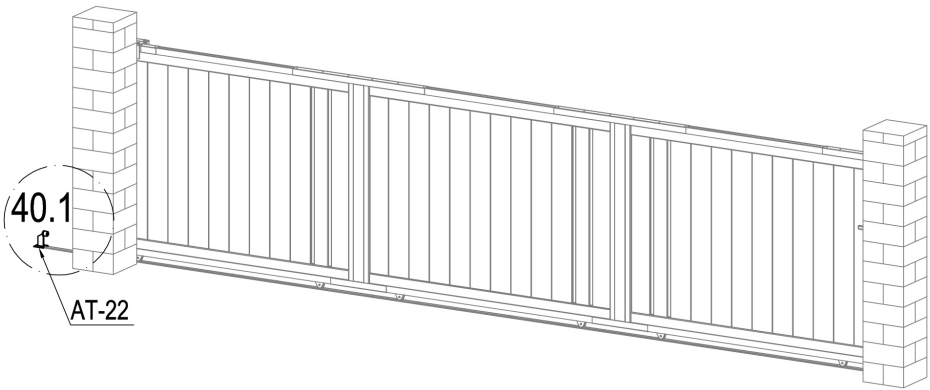

	AT-22	1
	LR-CS31	4
	AT-22J	4

