

CASANOVO

GIONA 400C140

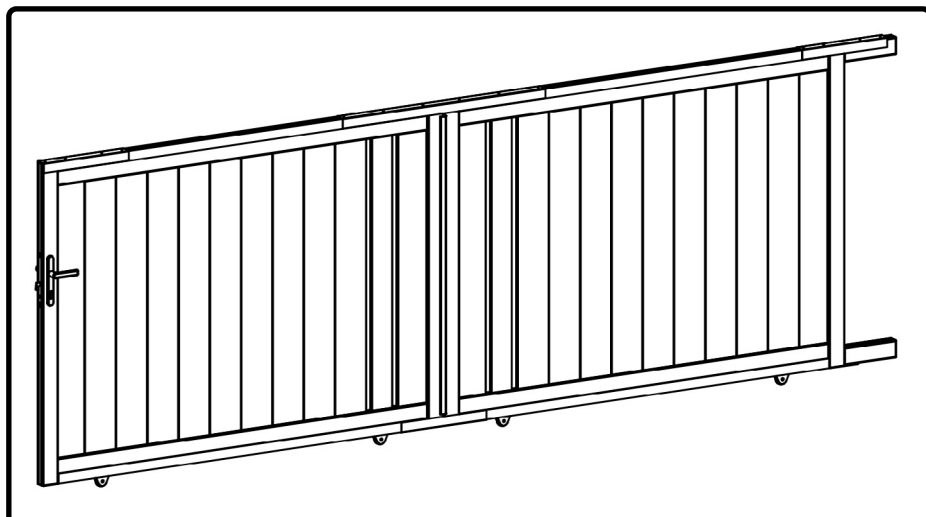

COM-001151 [x1]

COM-001153 [x1]

COM-001152 [x1]



7-8H



X 2



INSTRUCTION MANUAL / NOTICE DE MONTAGE / MONTAGEANLEITUNG / MANUAL DE MONTAJE / MANUAL DE MONTAGEM / MANUALE DI MONTAGGIO /
MONTAGEHANDLEIDING / INSTRUKCJA MONTAŻU / KÄYTTÖOHJEET / BRUKSANVISNING / BRUGSANVISNING / INSTRUCIUNI DE ASAMBLARE /
NAVODILA ZA SESTAVLJANJE / NÁVOD NA MONTÁŽ / ÖSSZESZERELÉSI ÚTMUTATÓ / NÁVOD K MONTÁŽI / UPUTE ZA INSTALACIJU /
ΟΔΗΓΙΕΣ ΣΥΝΑΡΜΟΛΟΓΗΣΗΣ / SURINKIMO INSTRUKCIJOS / MONTĀŽAS INSTRUKCIJAS

Ext.

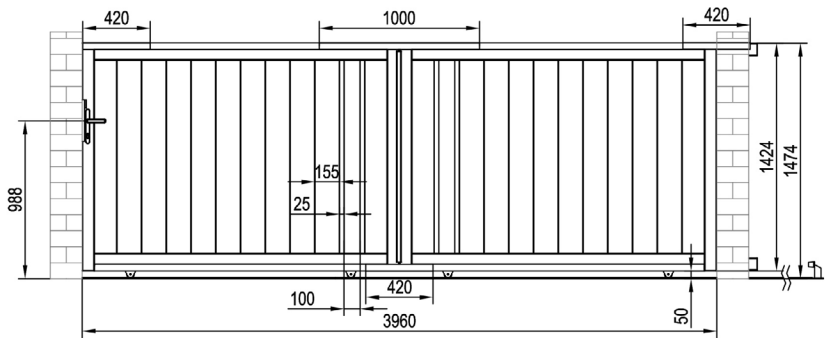

Int.

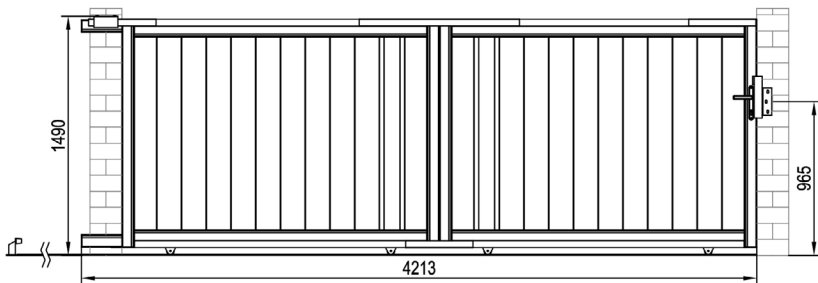

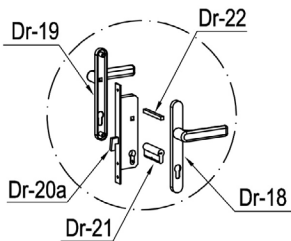
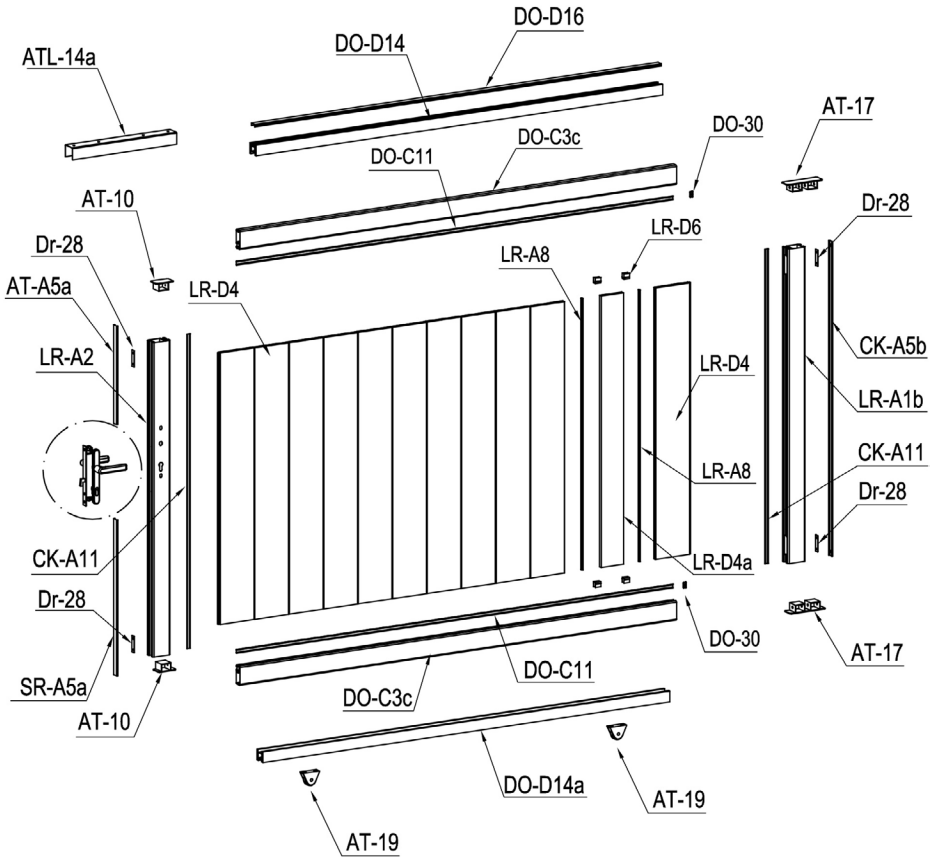

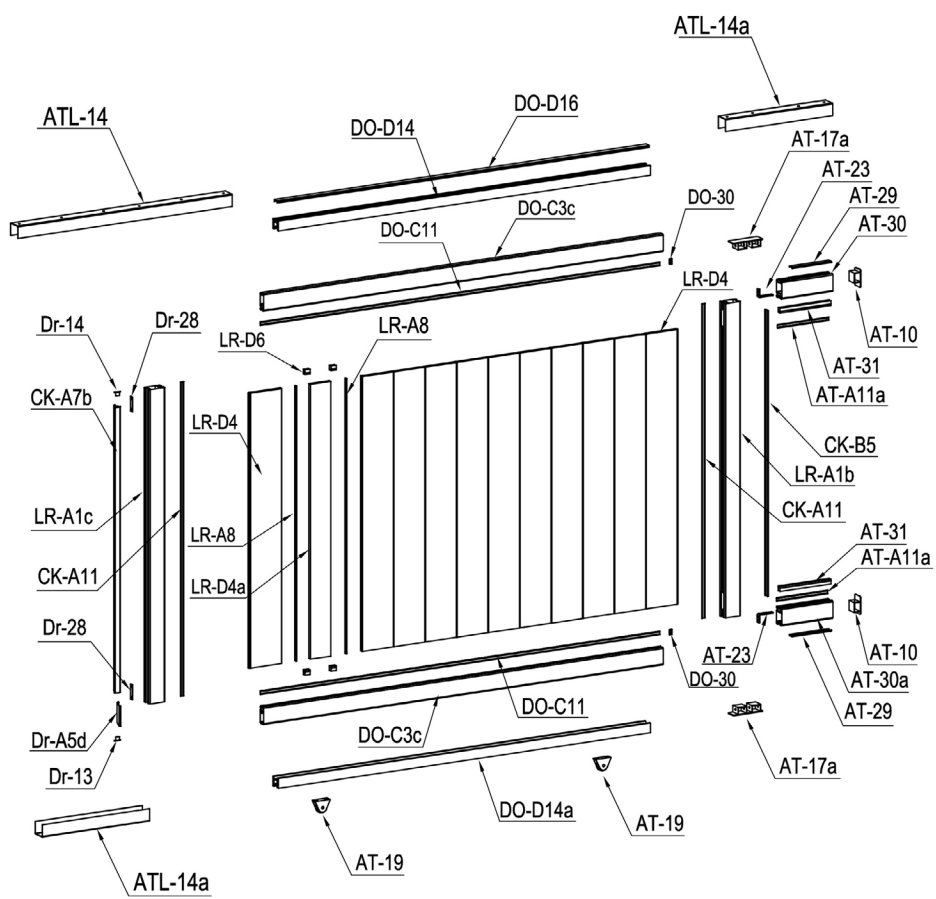

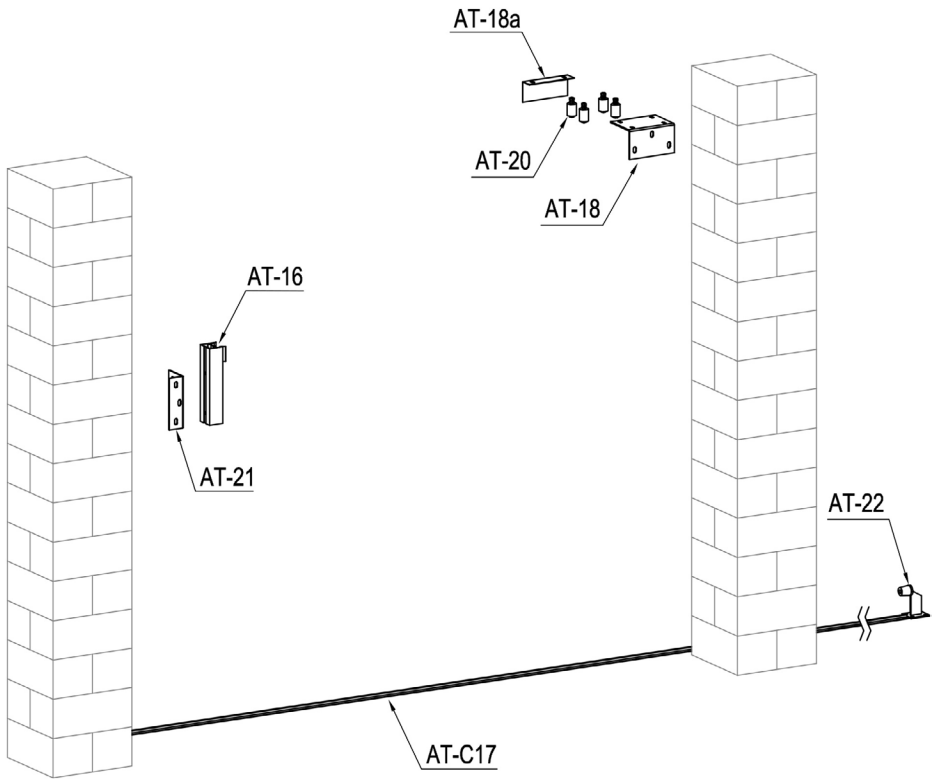



















































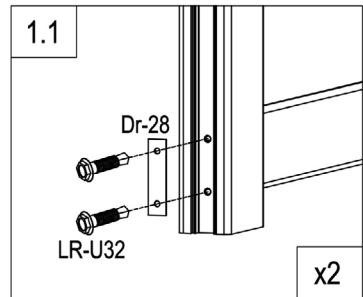
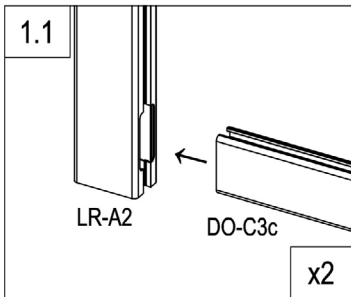
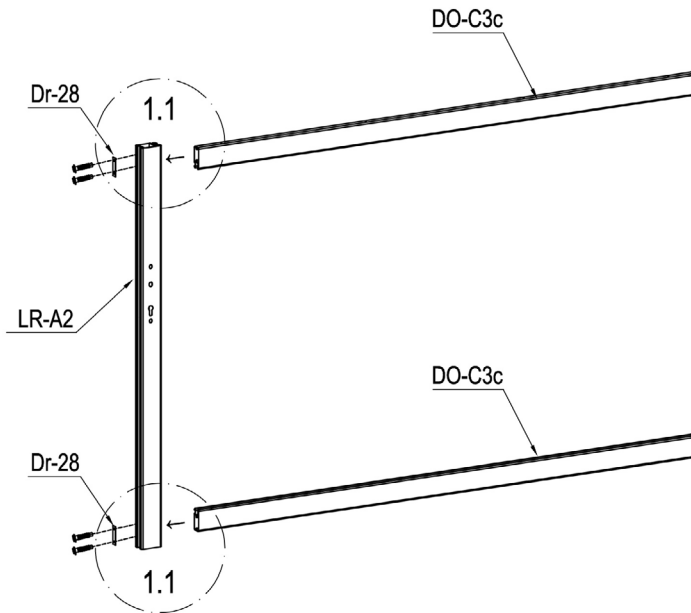

PART LIST

IMAGE	NO.	L.(mm)	QTY	IMAGE	NO.	L.(mm)	QTY
	LR-A1b	1418	2		ATL-14	1000	1
	LR-A1c	1418	1		ATL-14a	420	3
	LR-A2	1418	1		DO-30		4
	AT-30	250	1		AT-18		1
	AT-30a	250	1		AT-18a		1
	DO-C3c	1957	4		AT-19		4
	LR-D4	1245	22		AT-20		4
	LR-D4a	1245	2		AT-21		1
	CK-A5b	1418	1		AT-22		1
	CK-B5	1293	1		AT-23		2
	AT-A5a	395.5	1		Dr-18		1
	SR-A5a	782	1		Dr-19		1
	AT-29	193	2		Dr-20a		1
	Dr-A5d	52	1		Dr-21		1
	CK-A11	1418	4		Dr-22		1
	AT-A11a	250	2		Dr-25		1
	DO-C11	1957	4		Dr-25a		2
	AT-31	250	2		Dr-27		2
	LR-D6	25	8		Dr-28		6
	LR-A8	1245	4		AT-22J		7
	CK-A7b	1313	1		LR-U30	ST4x10	4
	DO-D14	1823	2		LR-U31	M8x60	10
	DO-D14a	1823	2		LR-U32	ST5.5x38	32
	DO-D16	1822	2		LR-U33	M8x130	4
	AT-16		1		LR-U34	ST4.8x38	26
	AT-C17	1580	5		LR-U35	ST4.2x19	54
	AT-17		2		LR-U36	M6x20	2
	AT-17a		2		LR-U37	M8x20	8
	AT-10		4		LR-U38	ST4x25	50
	Dr-13		1				
	Dr-14		1				

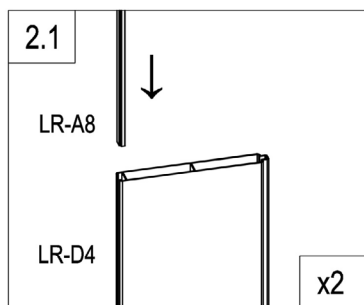
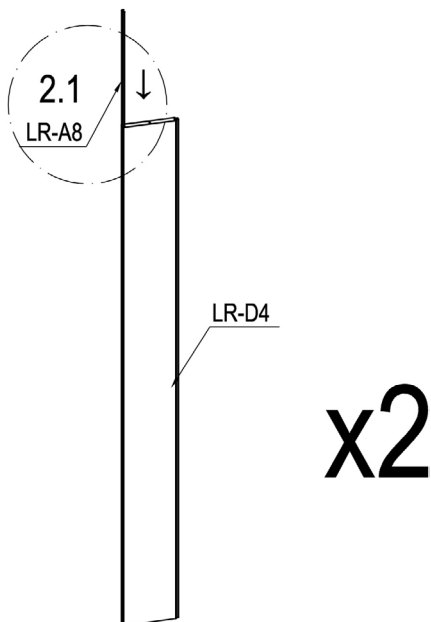

	LR-A2	1
	DO-C3c	2
	Dr-28	2
	LR-U32	4



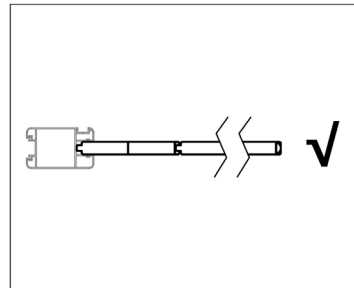
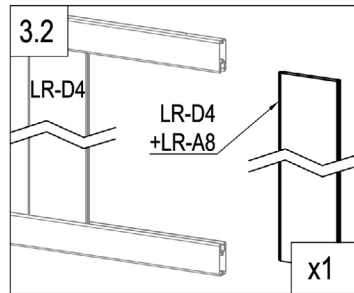
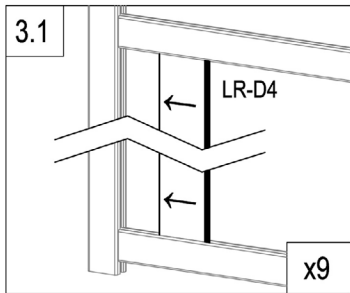
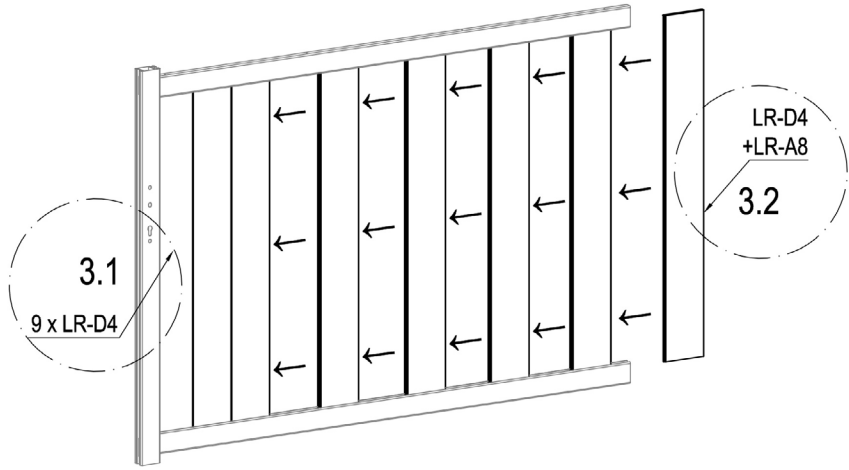

	LR-A8	2
	LR-D4	2



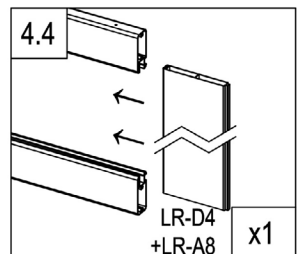
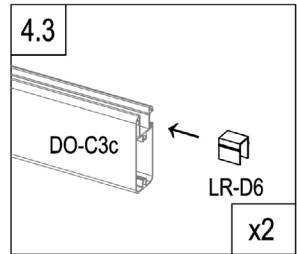
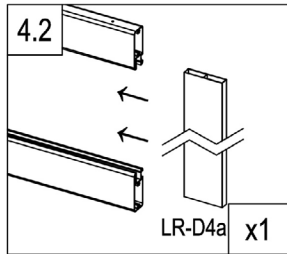
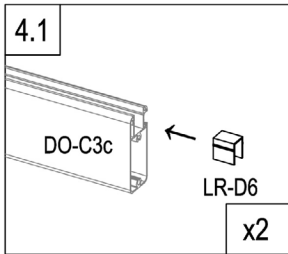
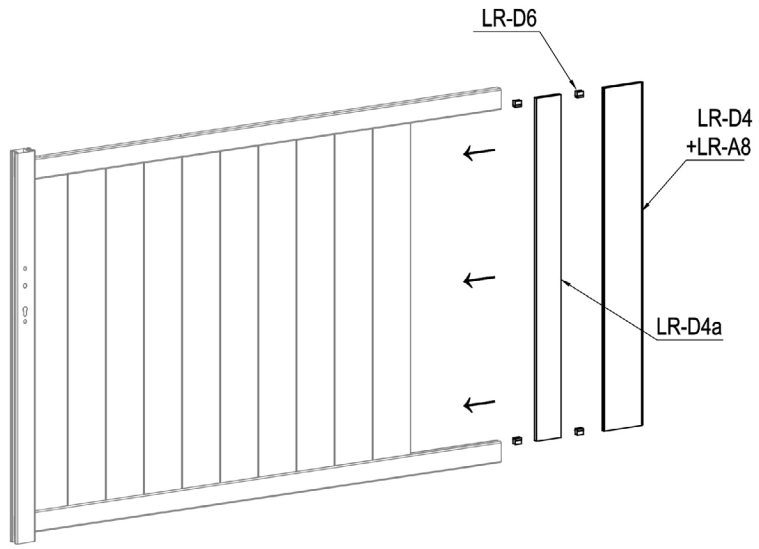

	LR-D4	9
---	-------	---



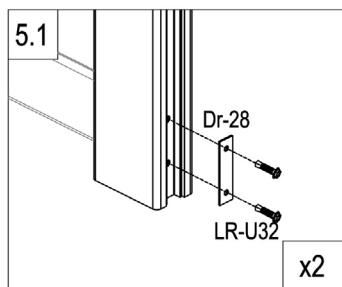
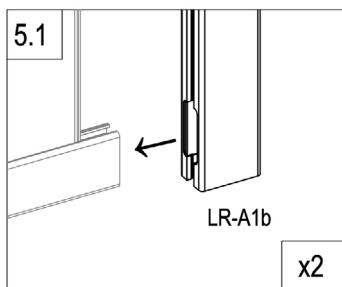
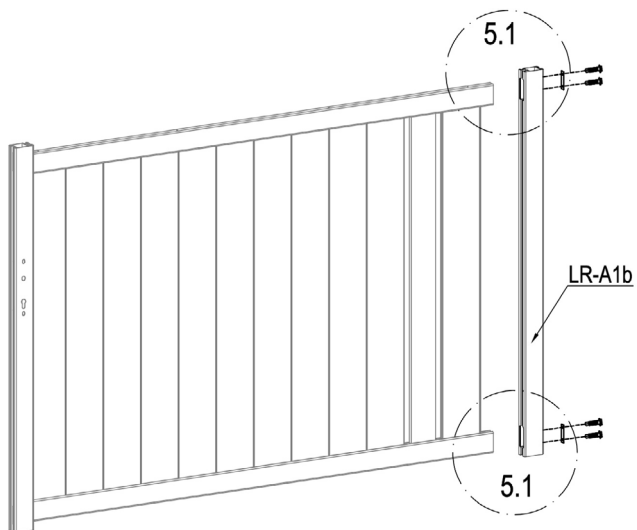

	LR-D4a	1
	LR-D6	4

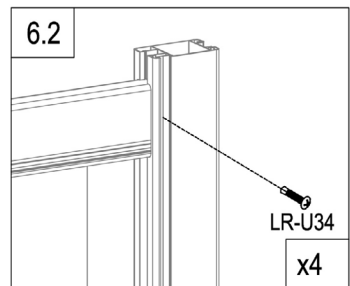
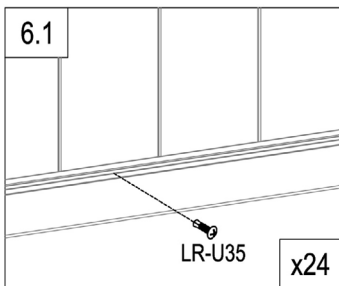
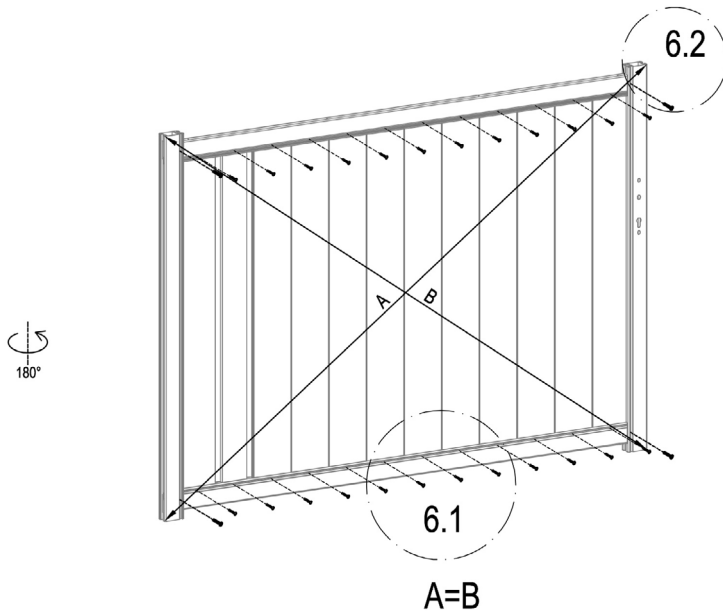

	LR-A1b	1
	Dr-28	2
	LR-U32	4



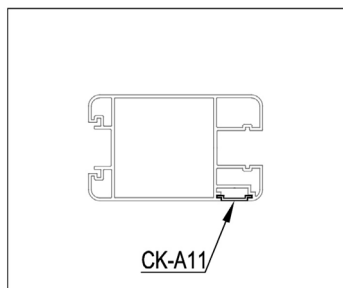
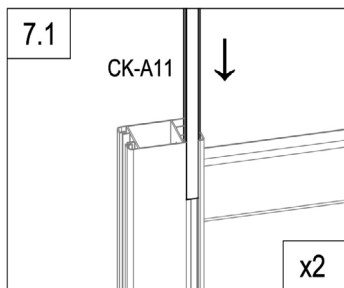
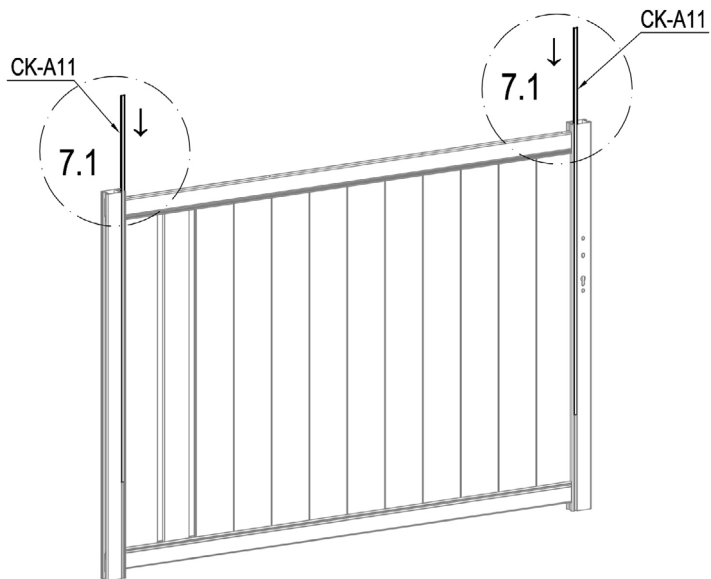

	LR-U35	24
	LR-U34	4

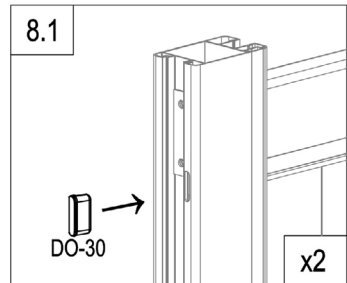
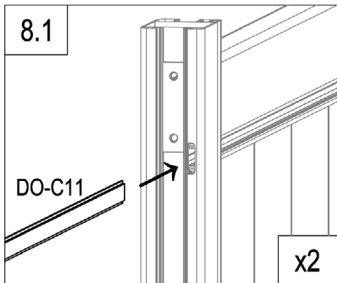
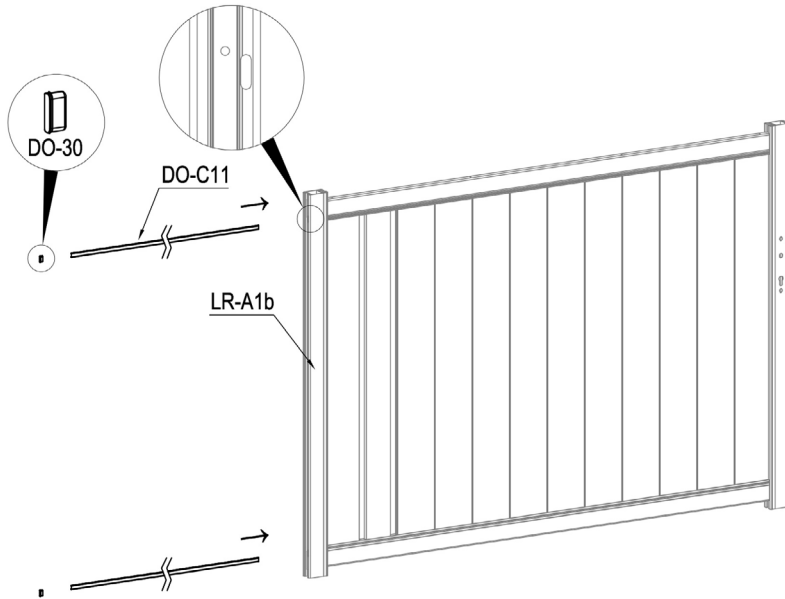

	CK-A11	2
---	--------	---



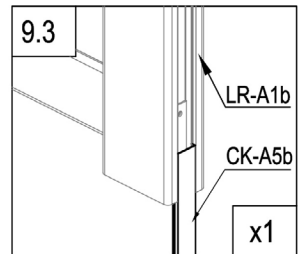
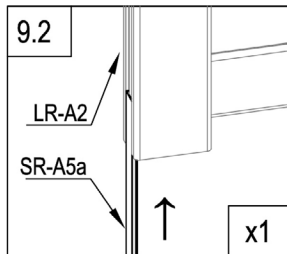
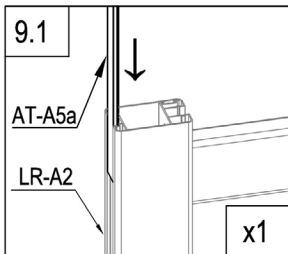
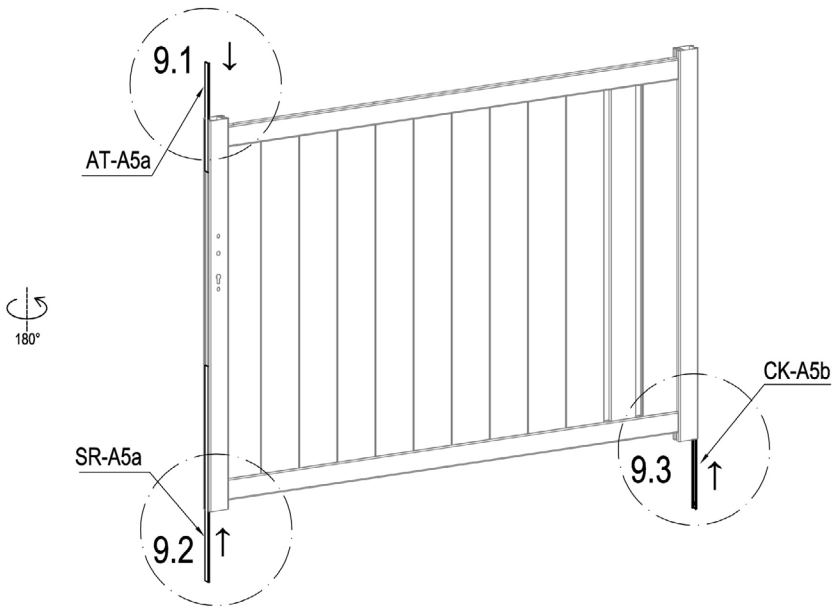

	DO-C11	2
	DO-30	2



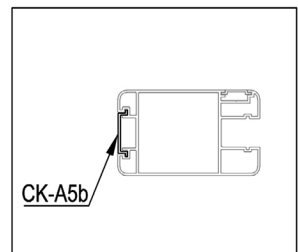

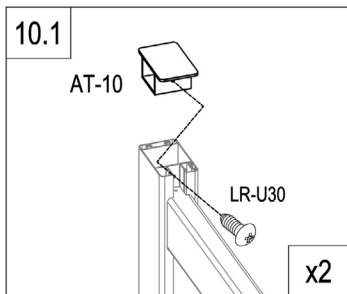
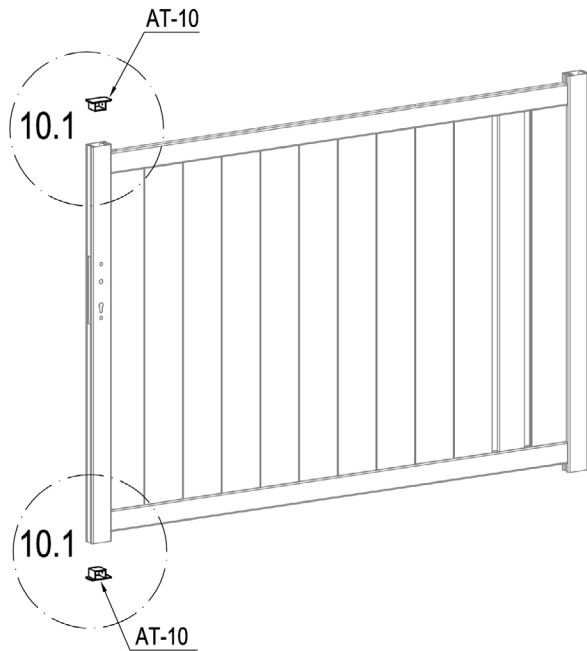

	CK-A5b	1
	AT-A5a	1
	SR-A5a	1



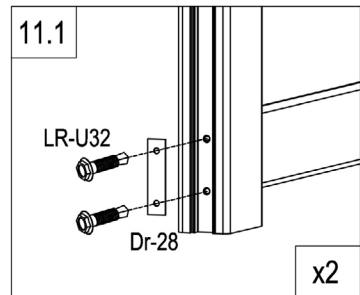
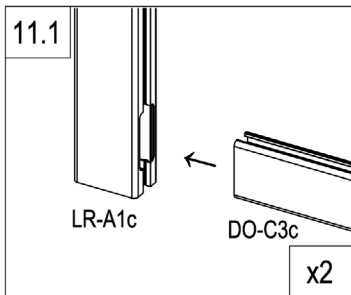
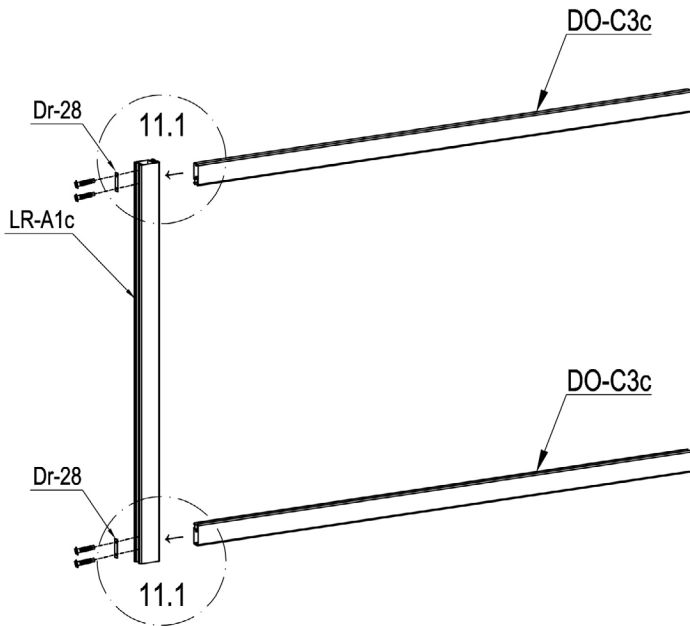



	AT-10	2
	LR-U30	2



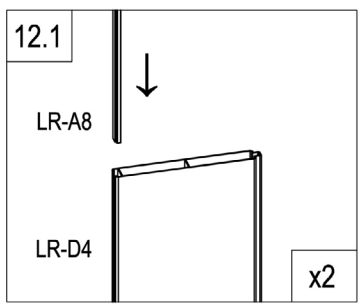
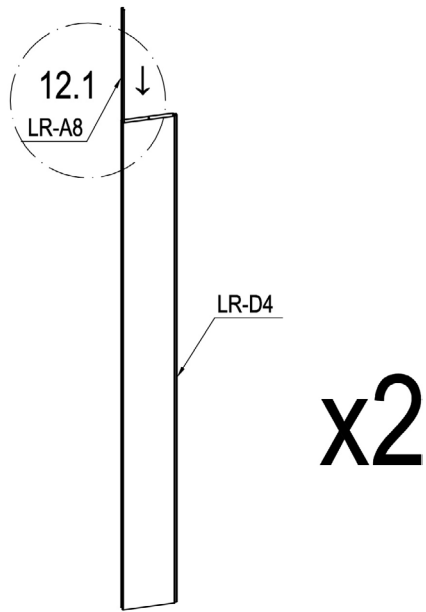

	LR-A1c	1
	DO-C3c	2
	Dr-28	2
	LR-U32	4

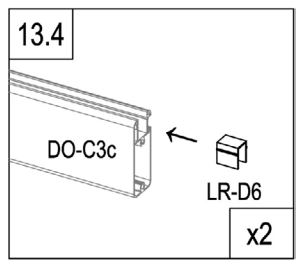
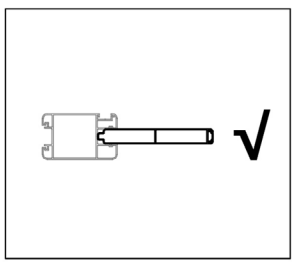
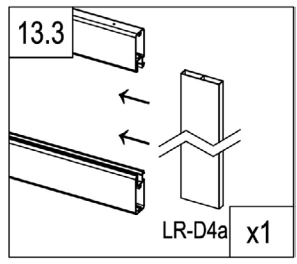
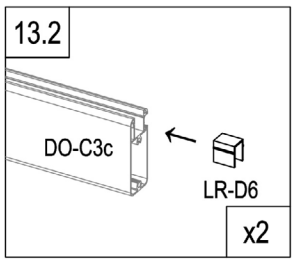
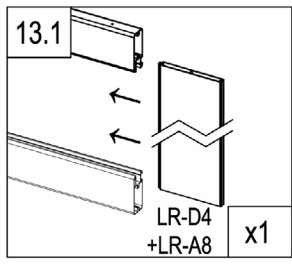
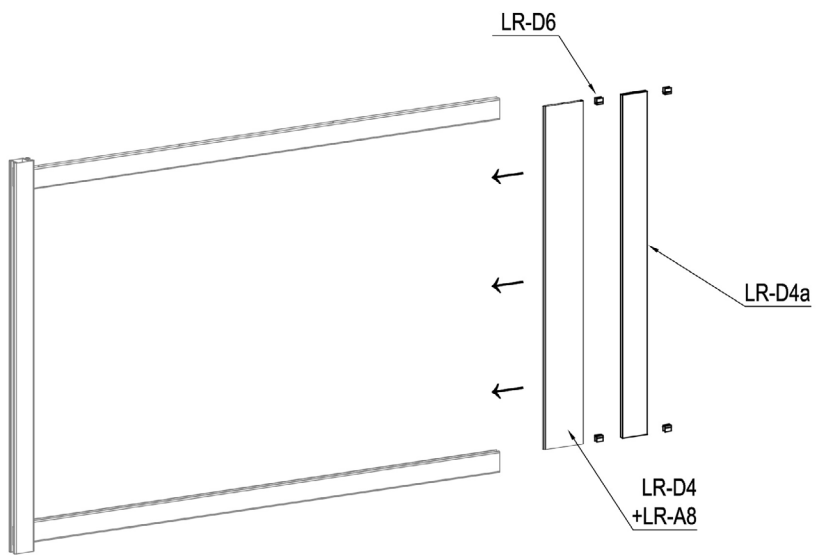

	LR-A8	2
	LR-D4	2



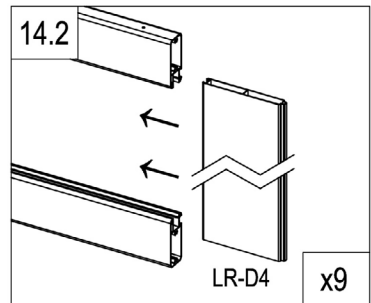
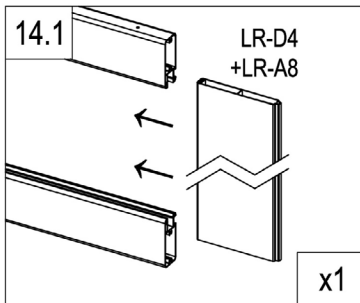
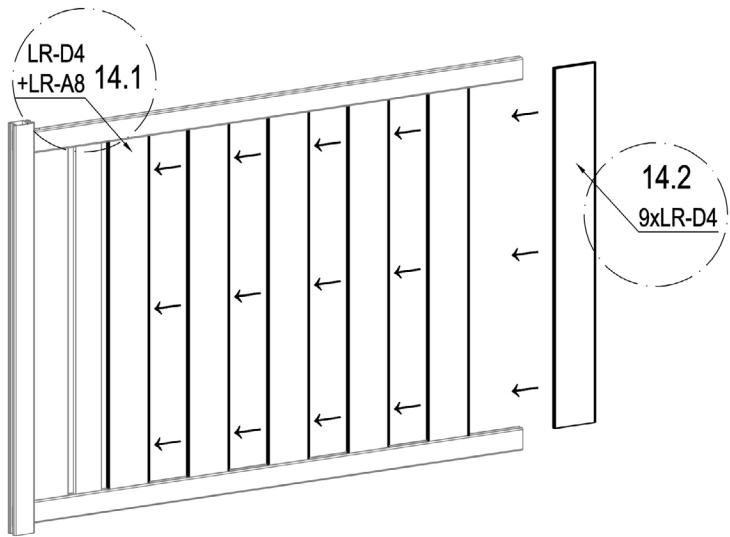

	LR-D4a	1
	LR-D6	4



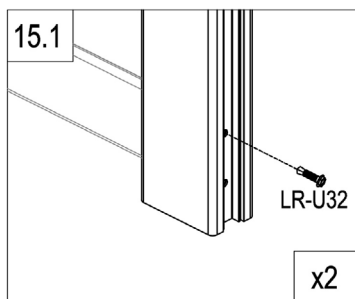
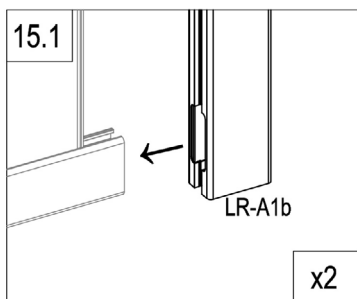
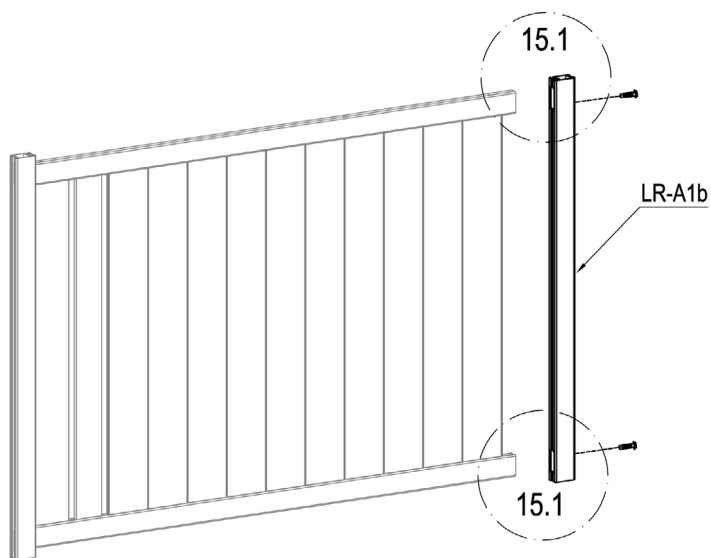

	LR-D4	9
---	-------	---

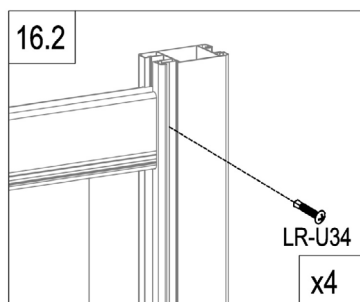
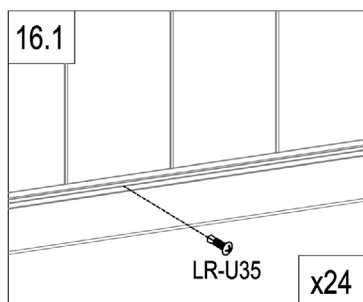
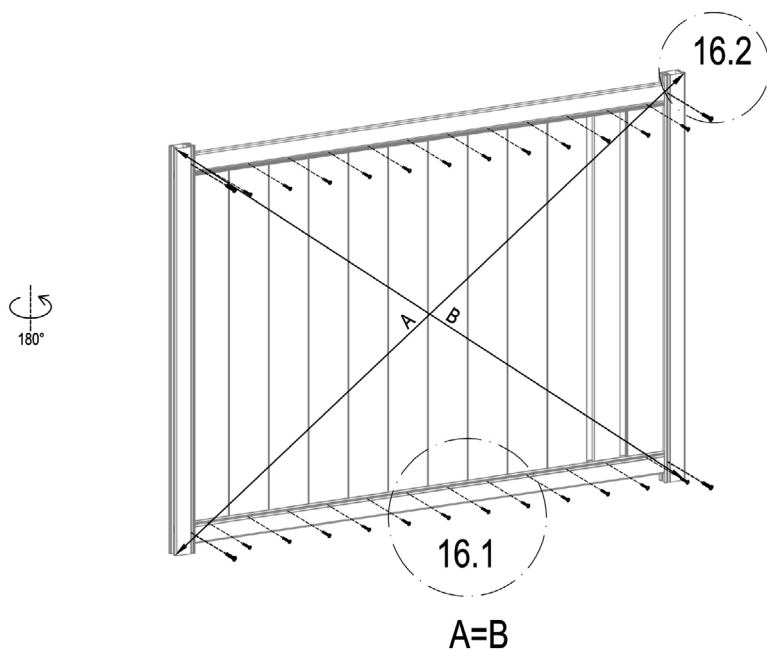

	LR-A1b	1
	LR-U32	2



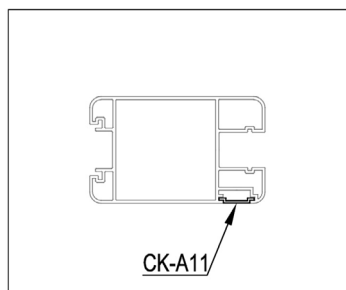
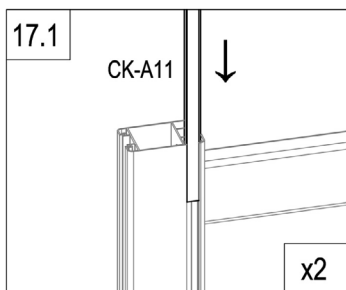
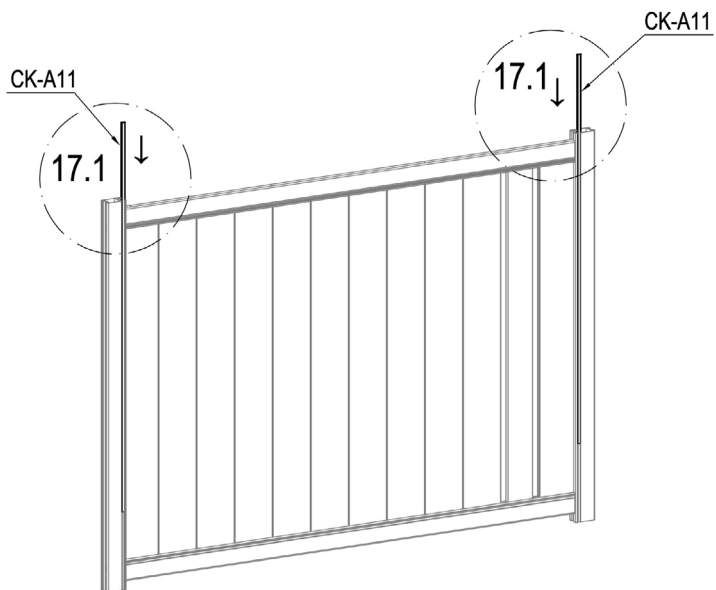

	LR-U35	24
	LR-U34	4

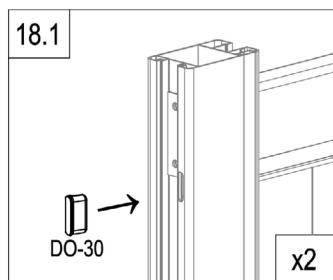
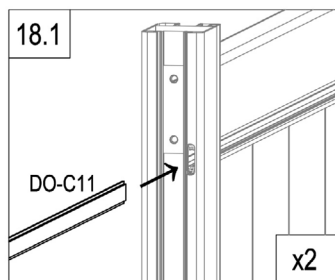
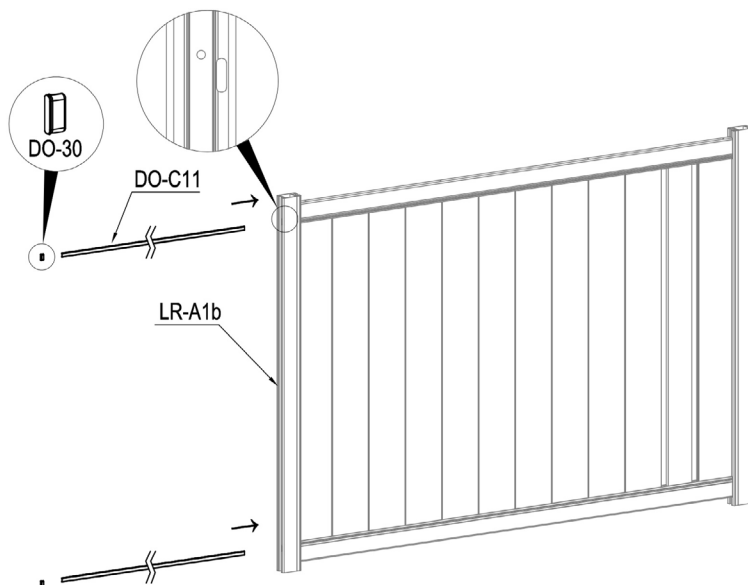

	CK-A11	2
---	--------	---



	DO-C11	2
	DO-30	2

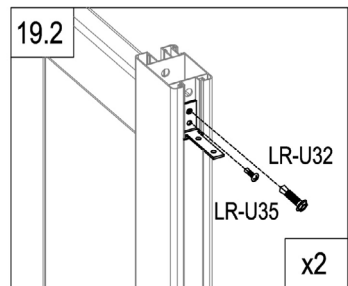
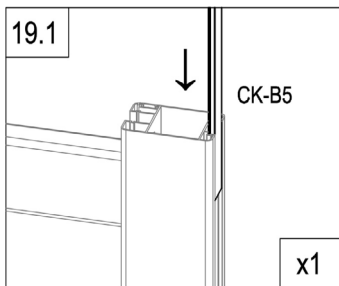
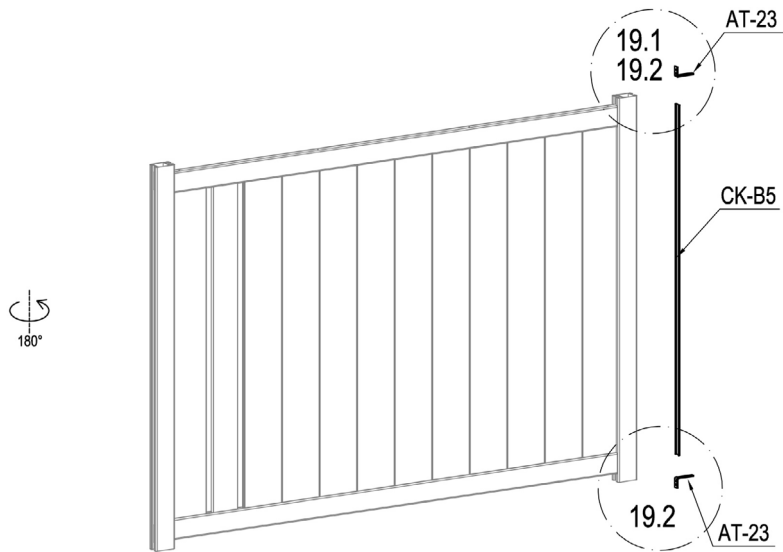



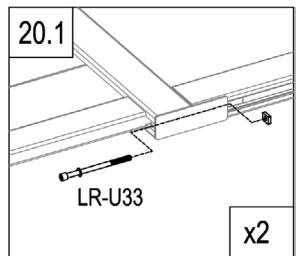
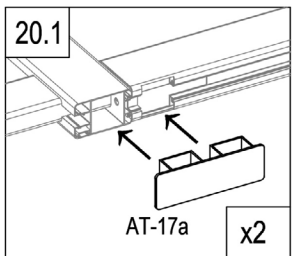
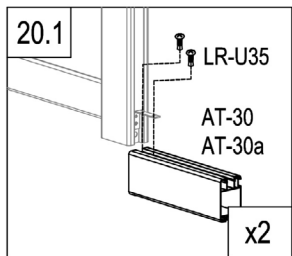
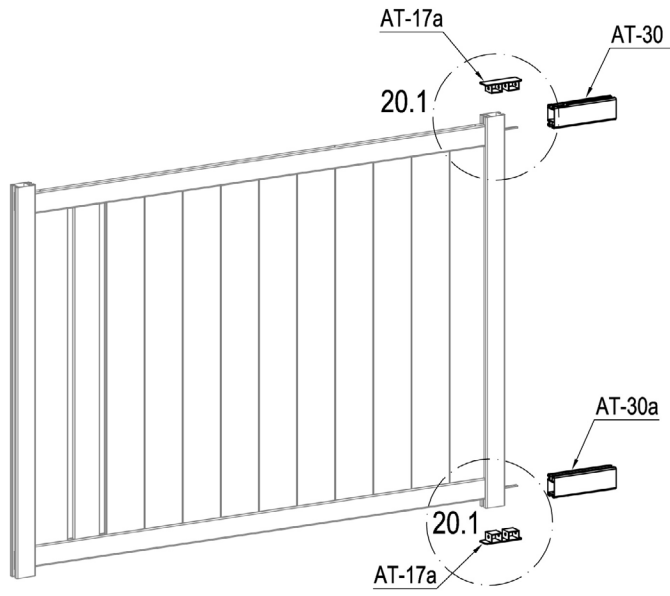

	CK-B5	1
	AT-23	2
	LR-U32	2
	LR-U35	2



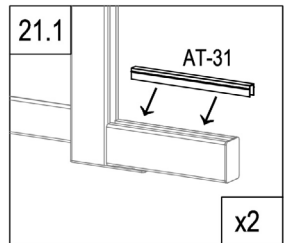
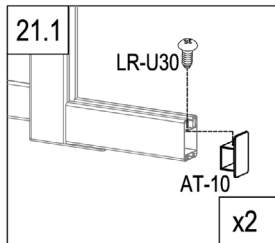
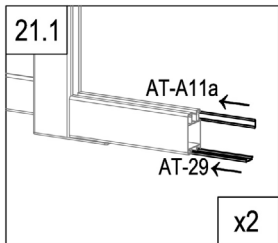
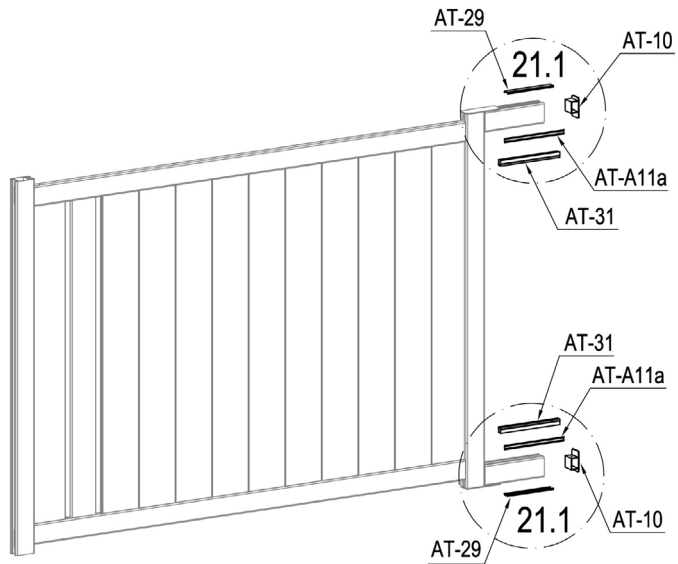

	AT-30	1
	AT-30a	1
	AT-17a	2

	LR-U33	2
	LR-U35	4



	AT-29	2
	AT-A11a	2
	AT-31	2

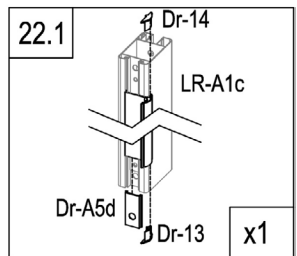
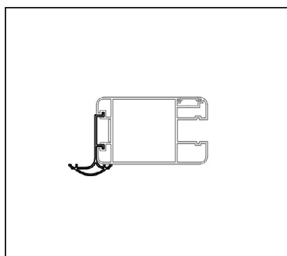
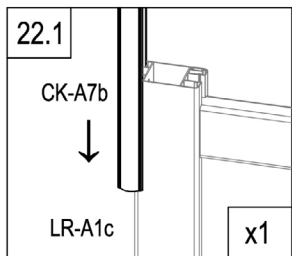
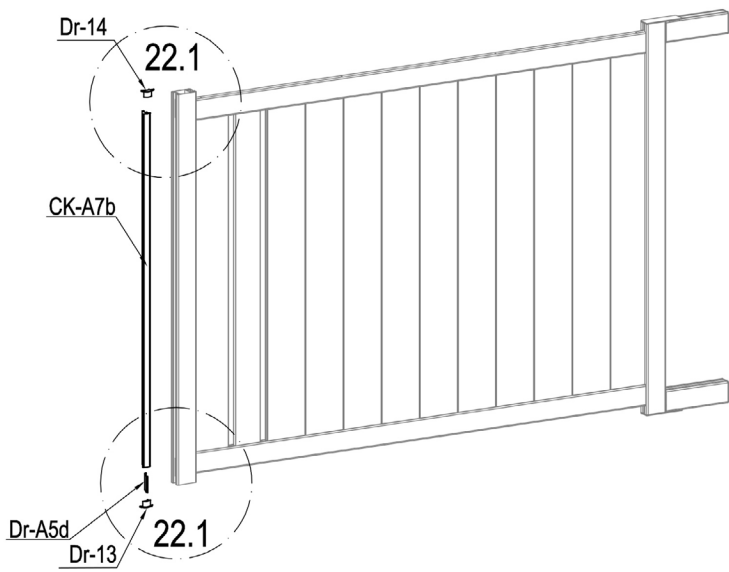

	AT-10	2
	LR-U30	2

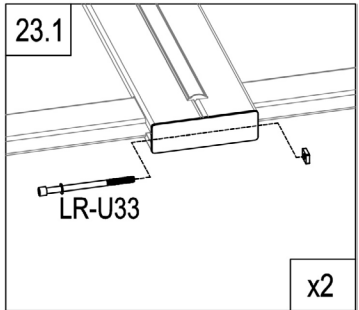
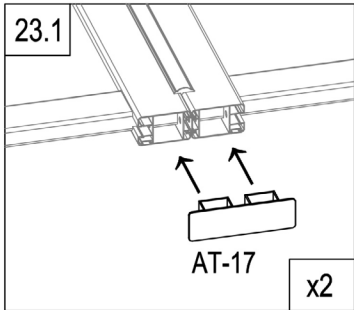
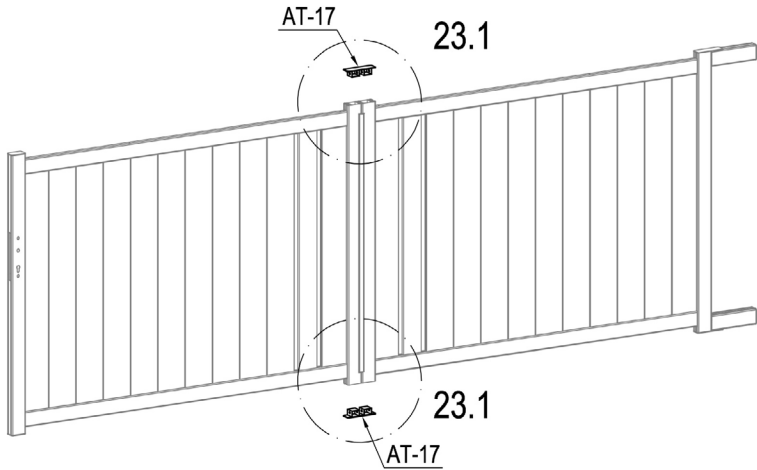

	CK-A7b	1
	Dr-A5d	1
	Dr-13	1
	Dr-14	1

CASANOVO



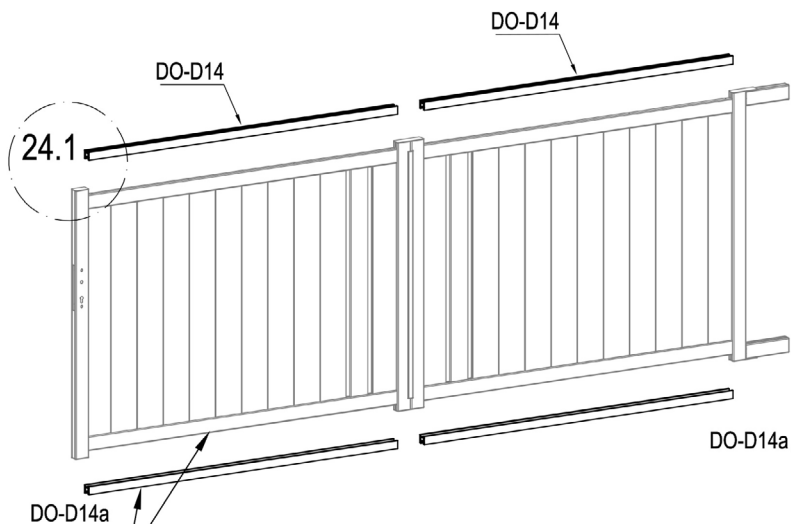

	AT-17	2
	LR-U33	2



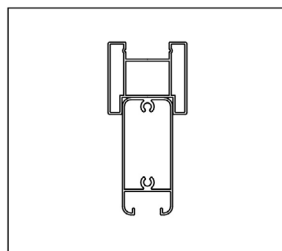
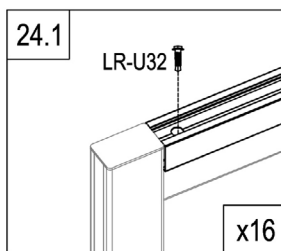
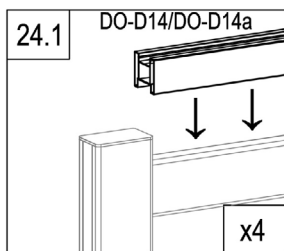

EN: These parts are made for connecting your gate's automation
 FR: Ces pièces sont faites pour relier l'automatisation de votre portail
 DE: Diese Teile sind für den Anschluss der Automatisierung Ihres Tores vorgesehen
 ES: Estas piezas están hechas para conectar la automatización de su puerta
 PT: Estas peças são feitas para ligar a automatização do seu portão
 IT: Queste parti sono realizzate per collegare l'automazione del vostro cancello
 NL: Deze onderdelen zijn gemaakt voor het aansluiten van de automatisering van uw poort.
 PL: Te części są wykonane do podłączenia automatyki bramy.



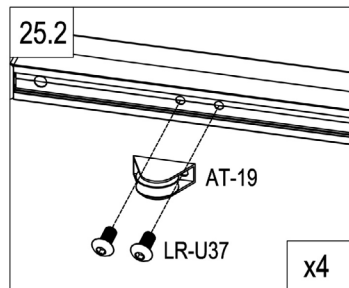
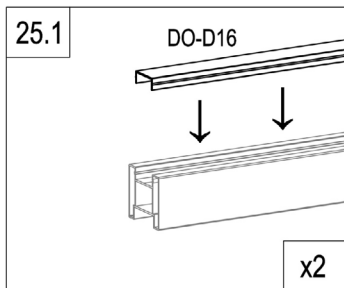
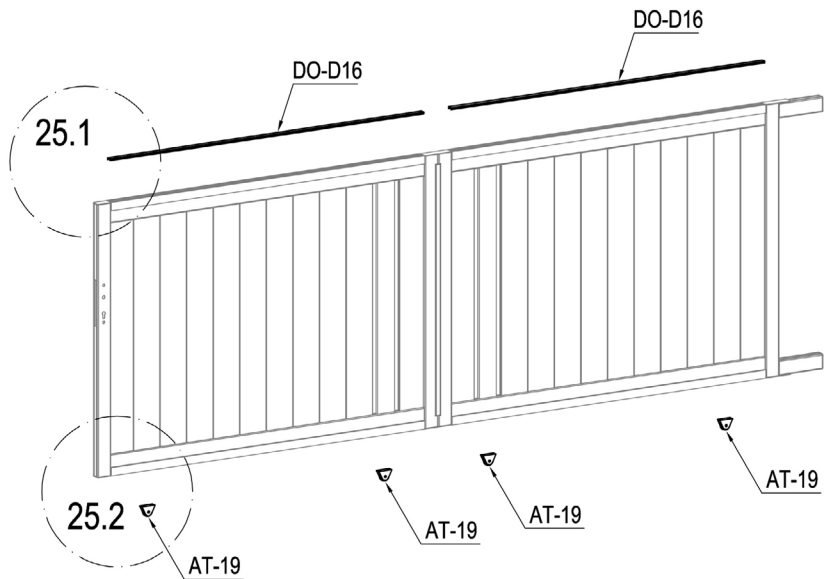

	DO-D14	2
	DO-D14a	2
	LR-U32	16

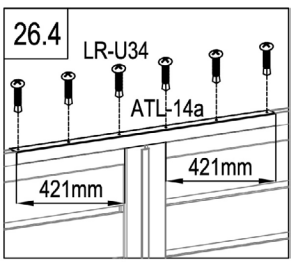
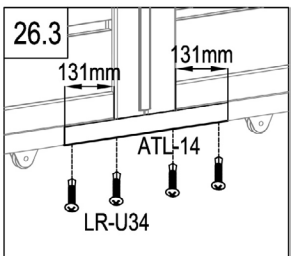
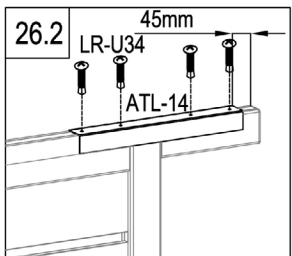
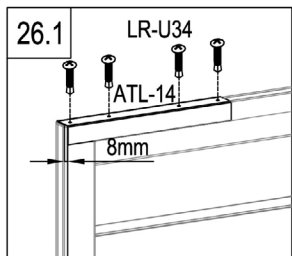
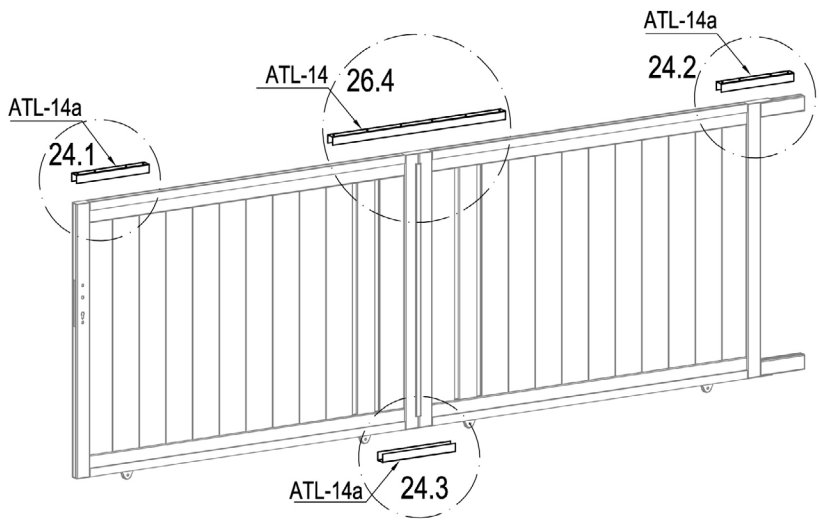

	DO-D16	2
	AT-19	4
	LR-U37	8



	ATL-14	1
	ATL-14a	3
	LR-U34	18

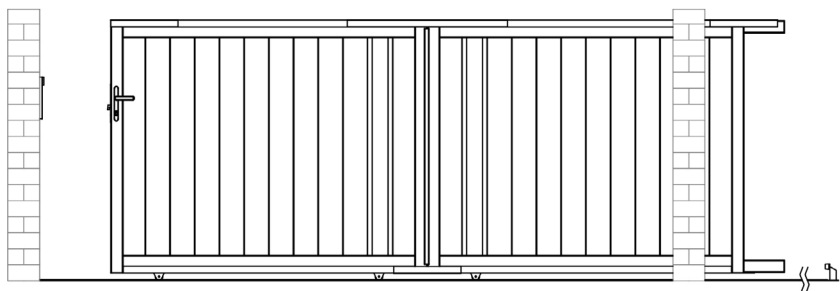

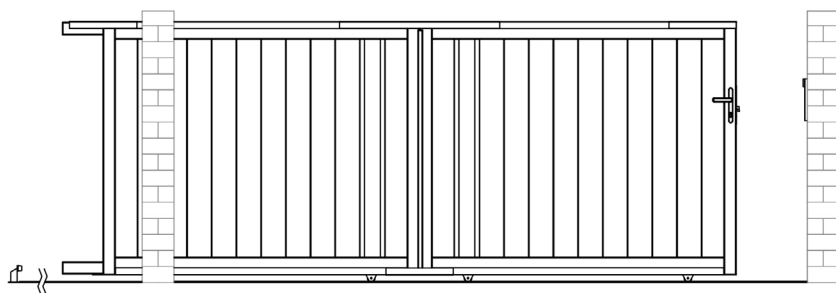

L

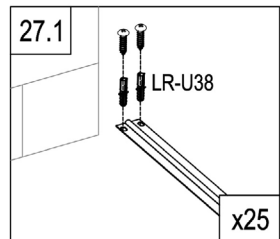
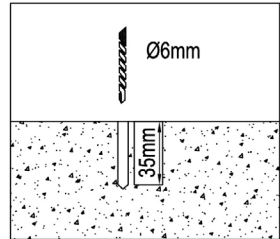
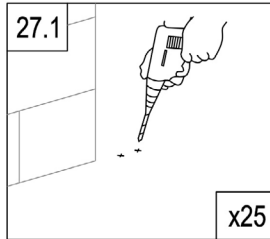
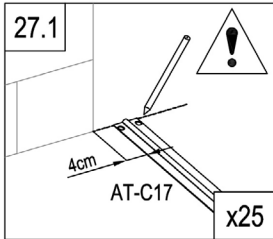
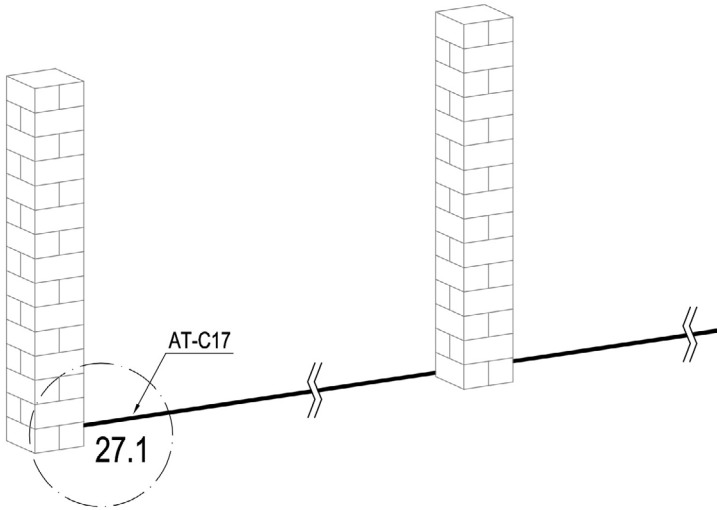

R

L



	AT-C17	5
	LR-U38	50

L

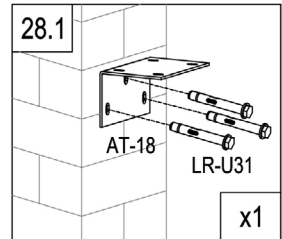
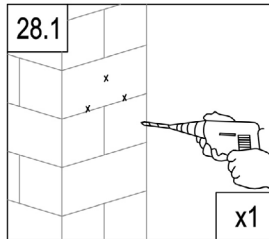
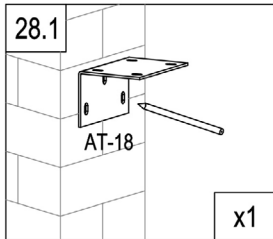
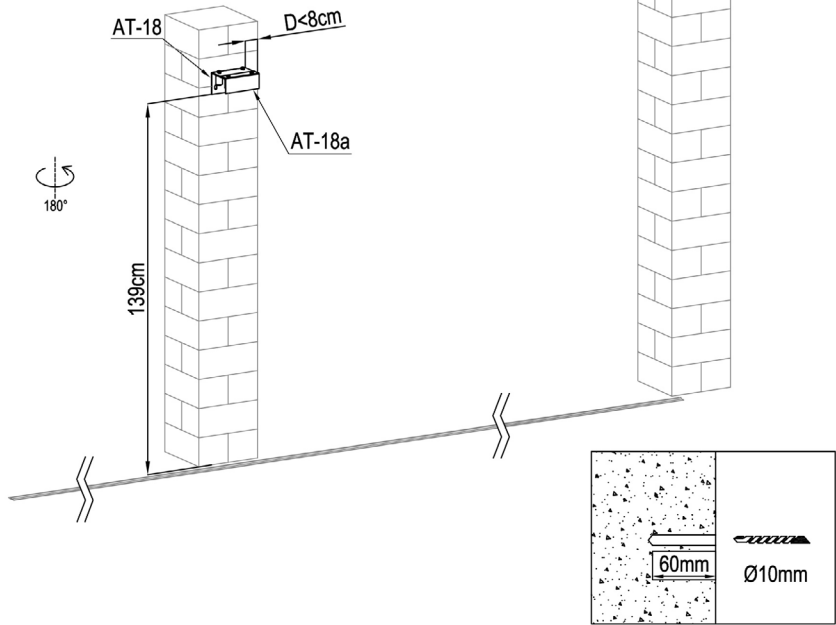

	AT-18	1
	AT-18a	1
	AT-20	4
	LR-U31	3

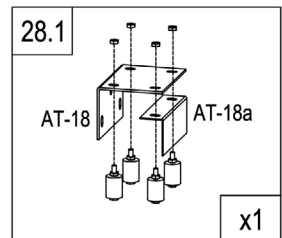
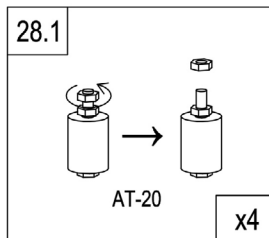

L

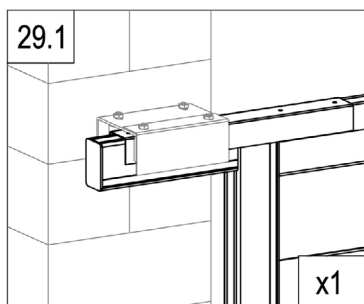
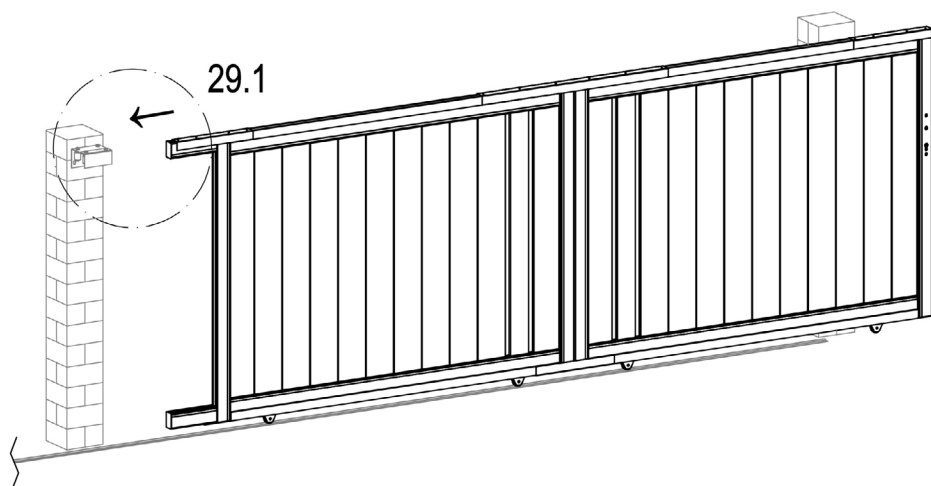

L

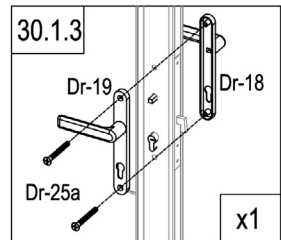
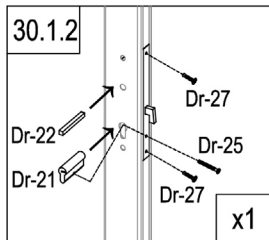
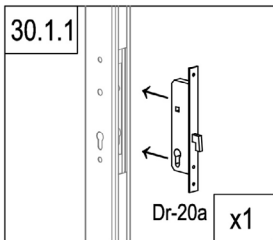
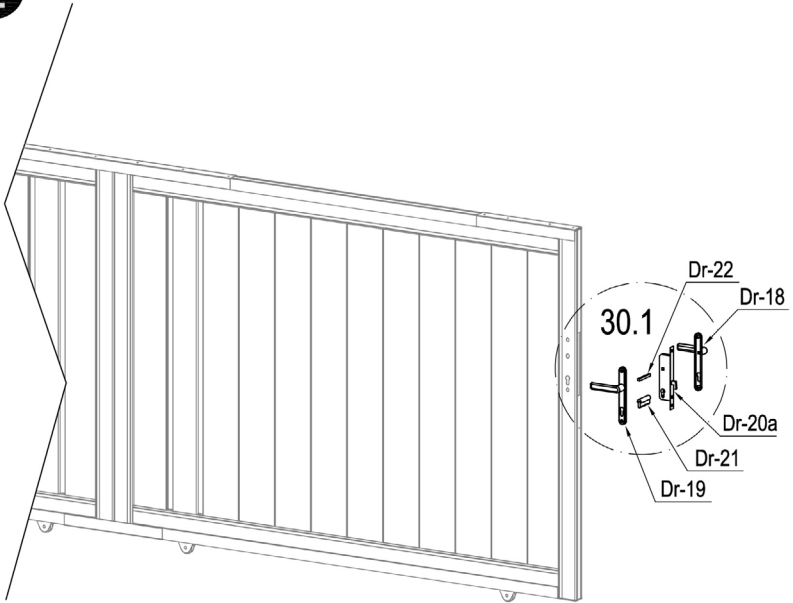

	Dr-20a	1
	Dr-21	1
	Dr-22	1
	Dr-25	1

	Dr-18	1
	Dr-19	1
	Dr-25a	2
	Dr-27	2

L

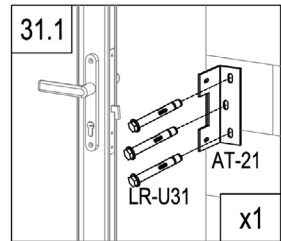
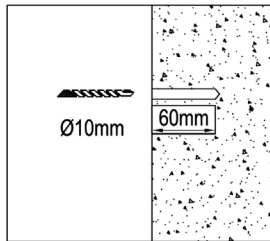
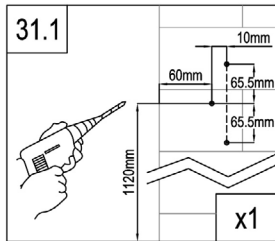
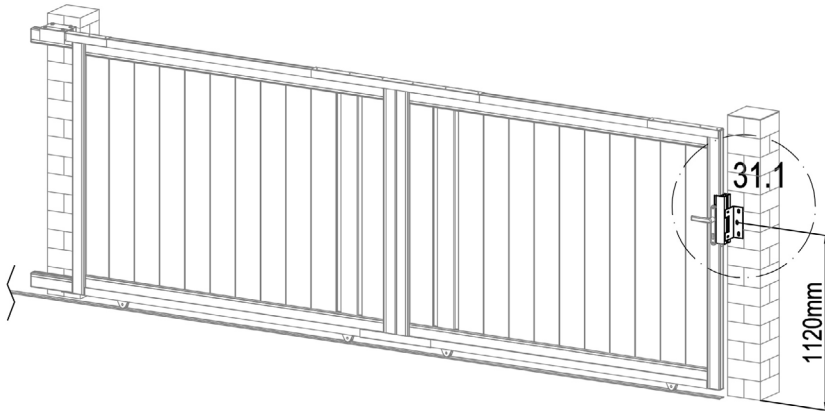

	AT-16	1
	AT-21	1
	LR-U36	2
	LR-U31	3
	AT-22J	3

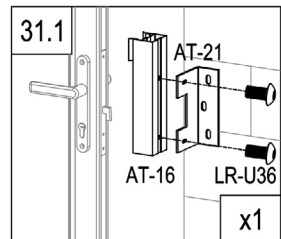
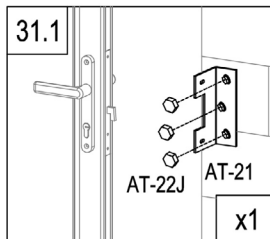

L

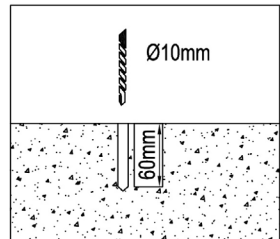
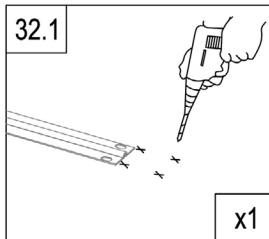
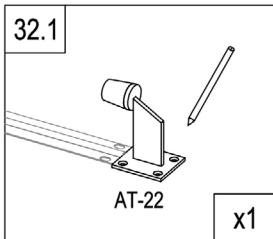
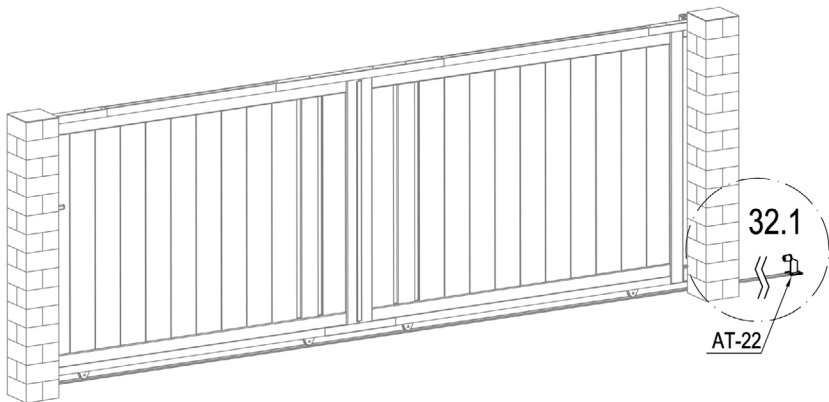

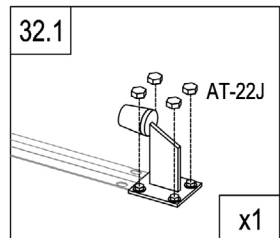
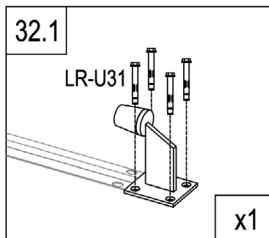

	AT-22	1
	LR-U31	4
	AT-22J	4

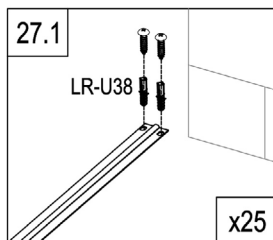
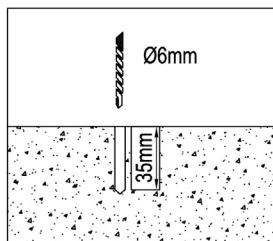
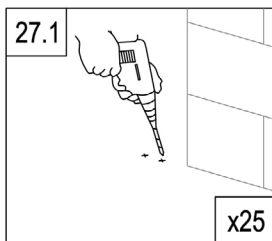
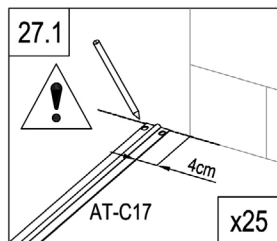
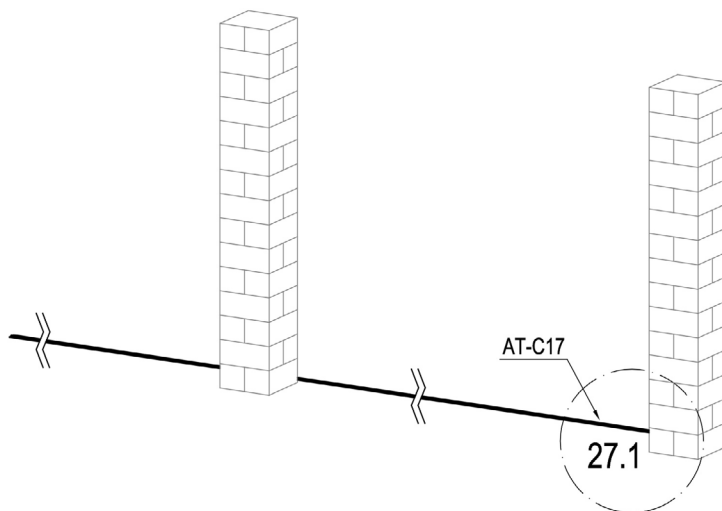

R



	AT-C17	5
	LR-U38	50

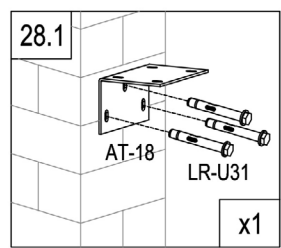
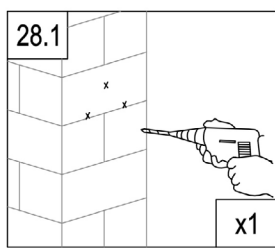
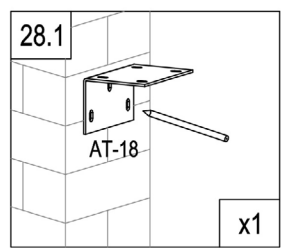
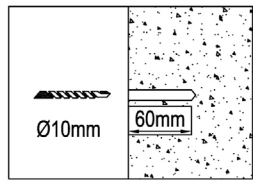
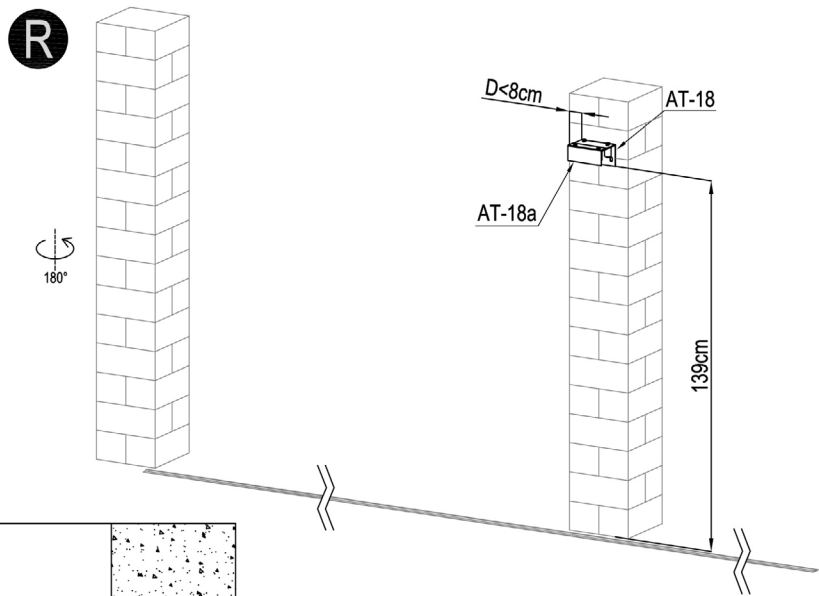

	AT-18	1
	AT-18a	1
	AT-20	4
	LR-U31	3

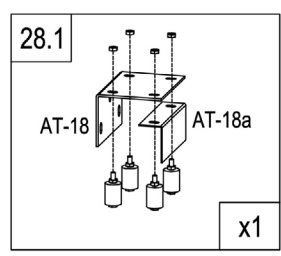
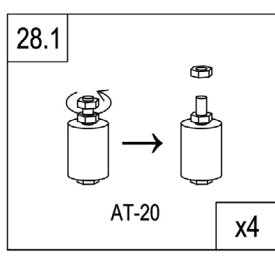

R

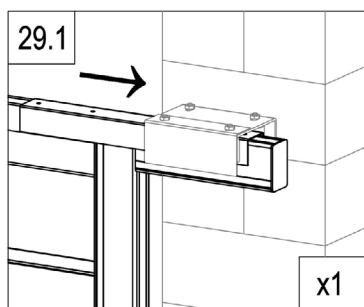
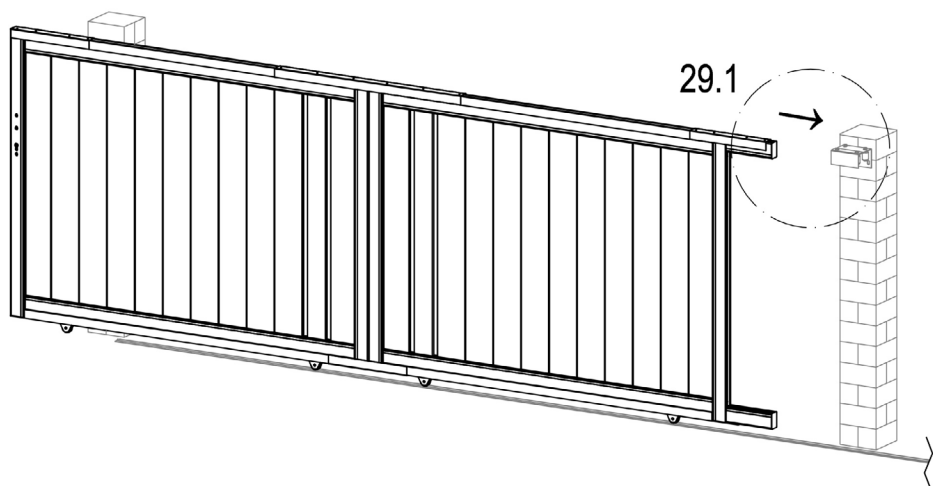

R

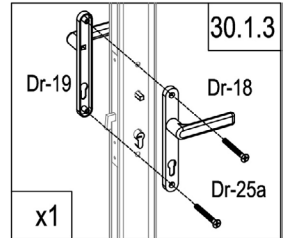
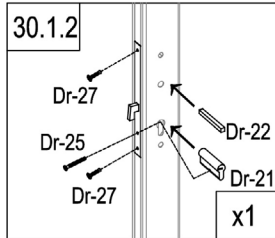
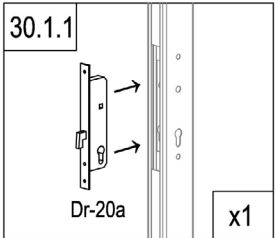
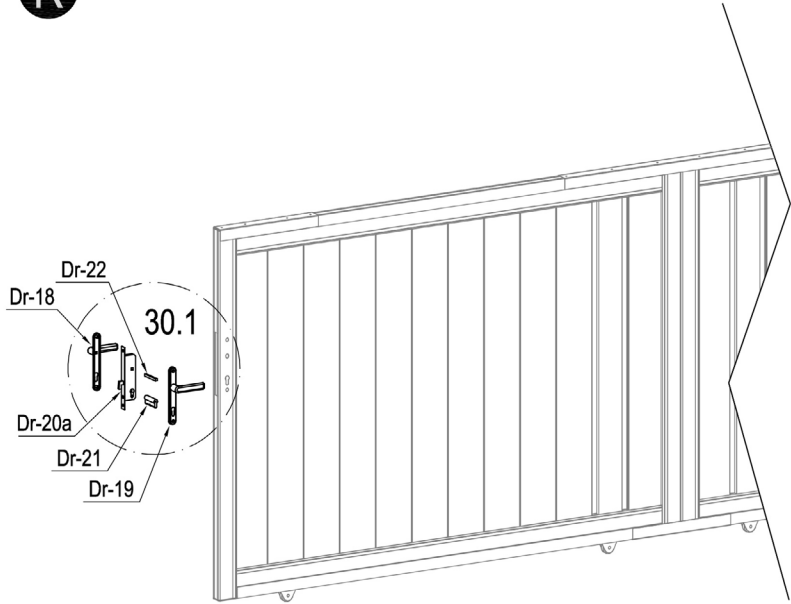

	Dr-20a	1
	Dr-21	1
	Dr-22	1
	Dr-25	1

	Dr-18	1
	Dr-19	1
	Dr-25a	2
	Dr-27	2

R

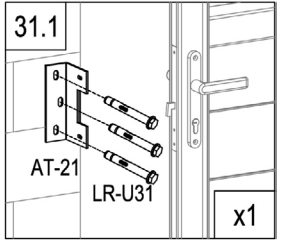
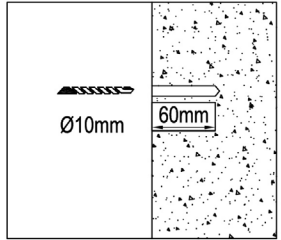
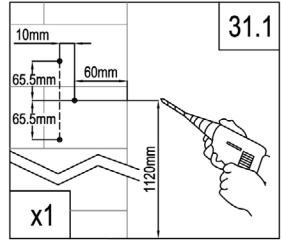
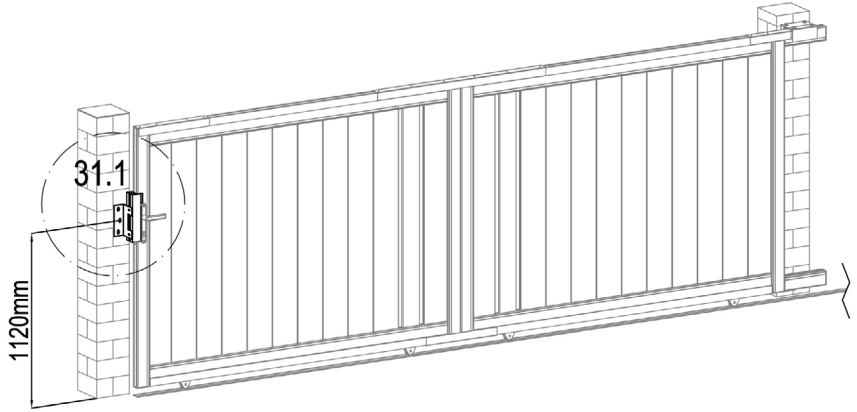

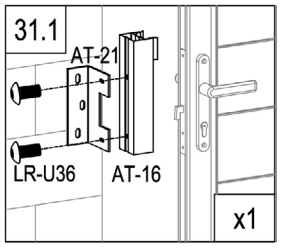
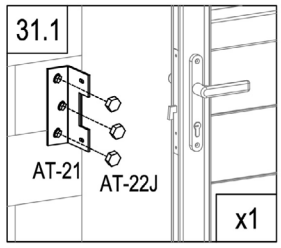

	AT-16	1
	AT-21	1
	LR-U36	2
	LR-U31	3
	AT-22J	3

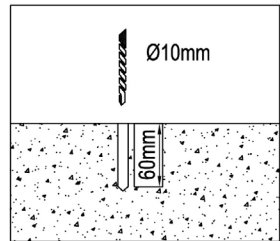
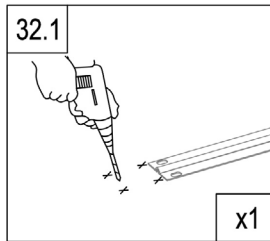
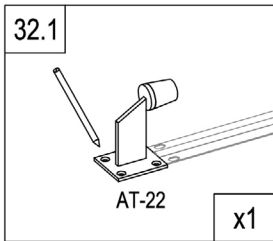
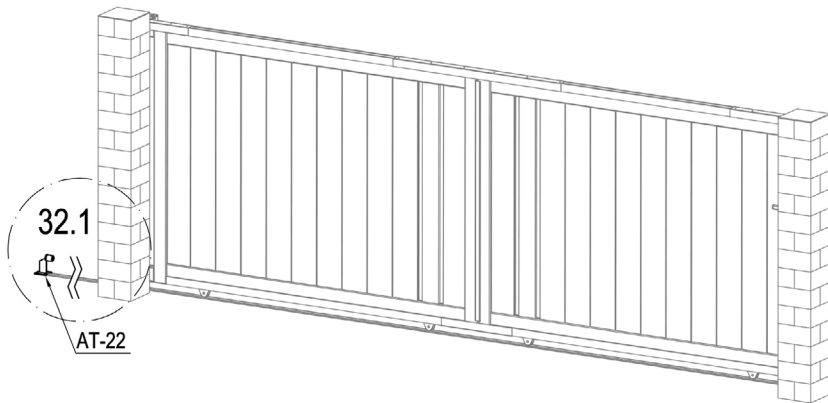

R



	AT-22	1
	LR-U31	4
	AT-22J	4

