

CASANOVO

GIONA 350C180

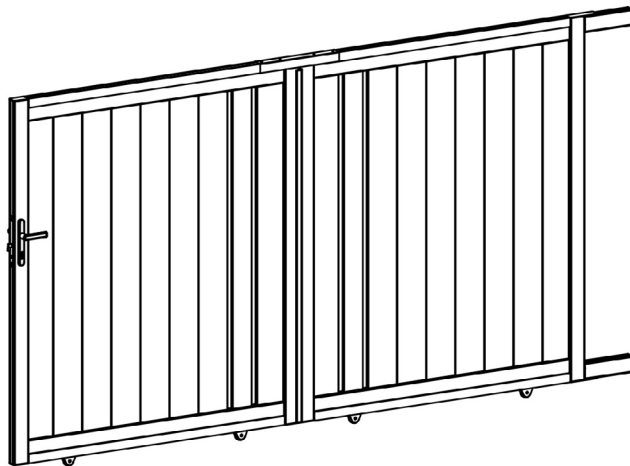

COM-001148 [x1]

COM-001150 [x1]

COM-001149 [x1]



7-8H



X 2



INSTRUCTION MANUAL / NOTICE DE MONTAGE / MONTAGEANLEITUNG / MANUAL DE MONTAJE / MANUAL DE MONTAGEM / MANUALE DI MONTAGGIO /
MONTAGEHANDLEIDING / INSTRUKCJA MONTAŻU / KÄYTTÖOHJEET / BRUKSANVISNING / BRUGSANVISNING / INSTRUCȚIUNI DE ASAMBLARE /
NAVODILA ZA SESTAVLJANJE / NÁVOD NA MONTÁŽ / ÖSSZESZERELÉSI ÚTMUTATÓ / NÁVOD K MONTÁŽI / UPUTE ZA INSTALACIJU /
ΟΔΗΓΙΕΣ ΣΥΝΑΡΜΟΛΟΓΗΣΗΣ / SURINKIMO INSTRUKCIJOS / MONTĀŽAS INSTRUKCIJAS

Ext.

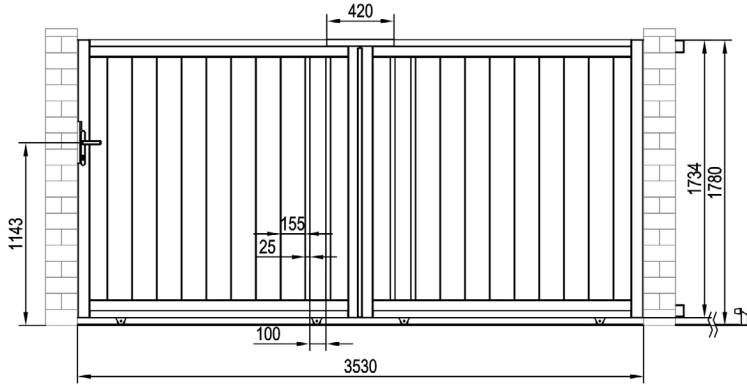

Int.

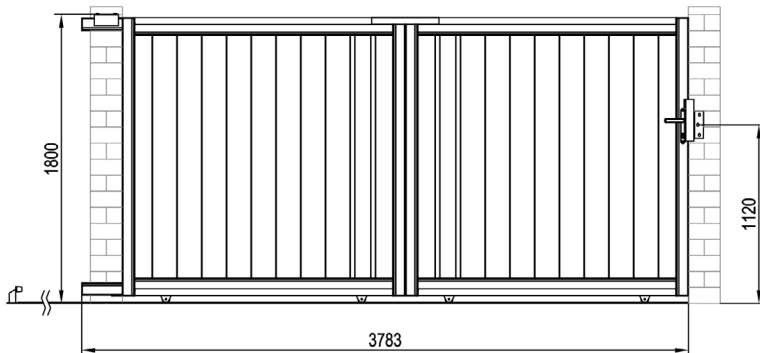



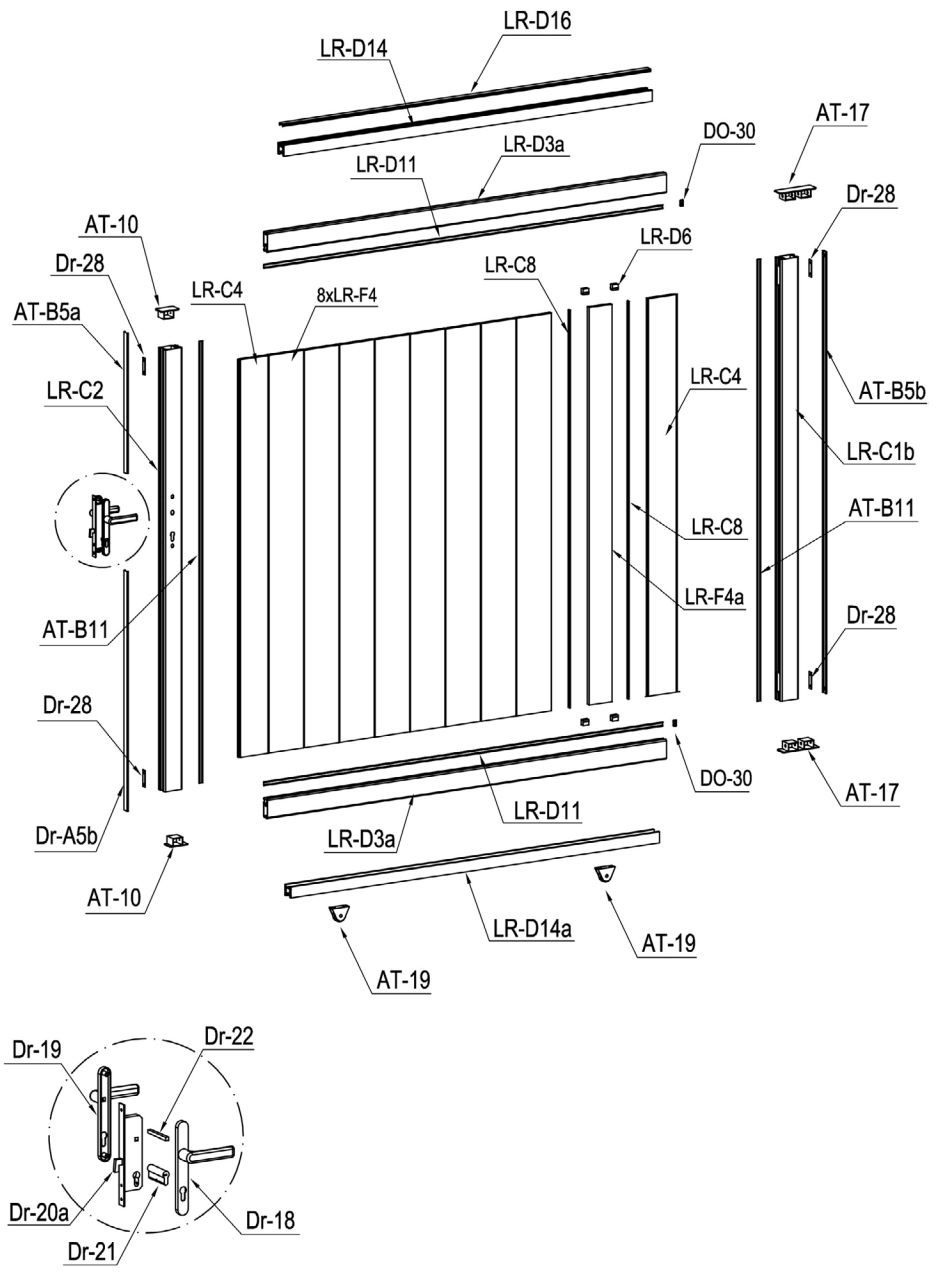

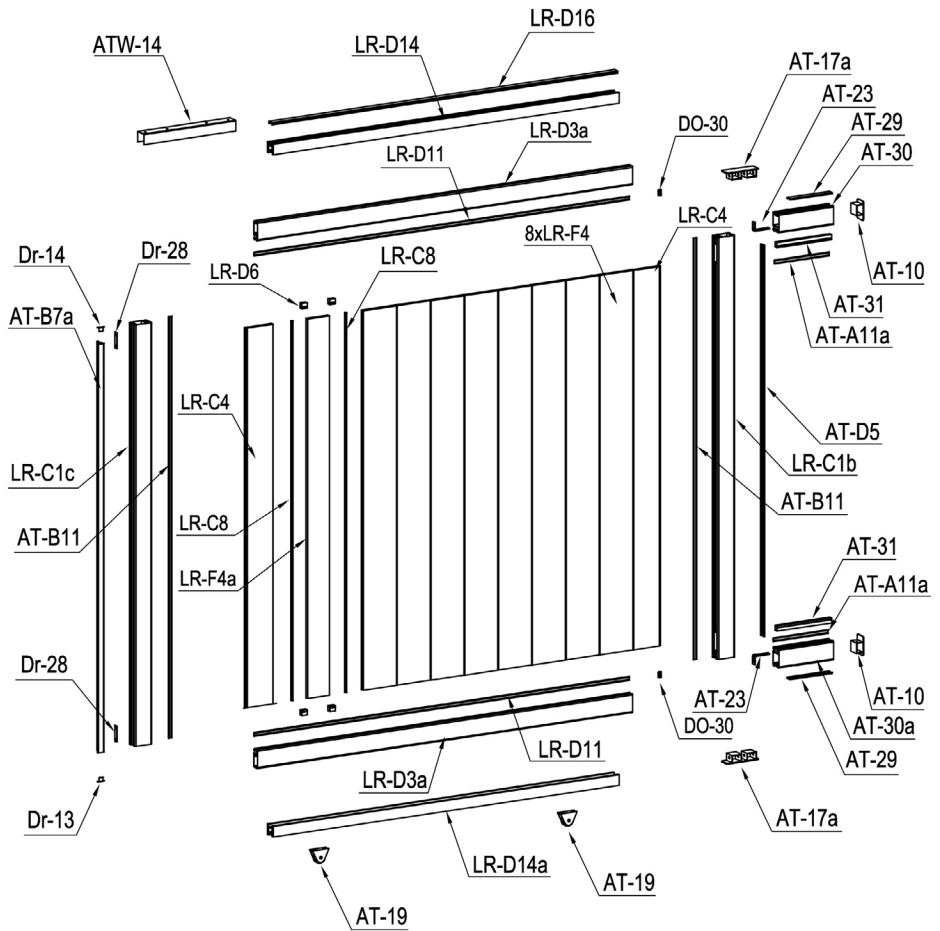

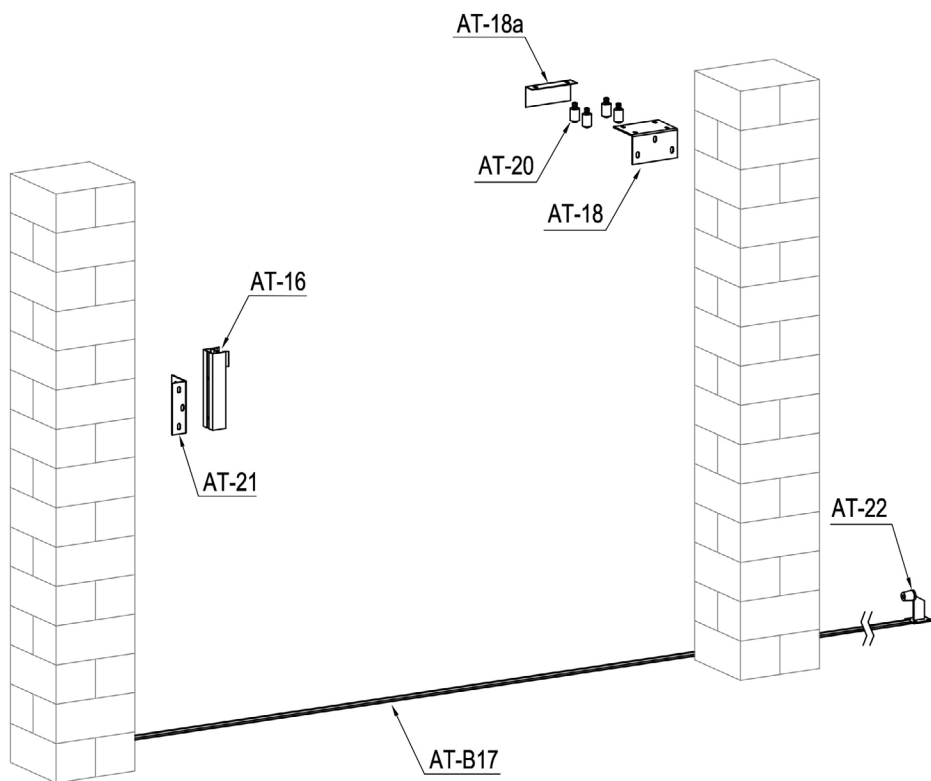







































CASANOVA











PART LIST

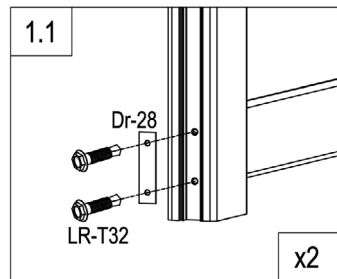
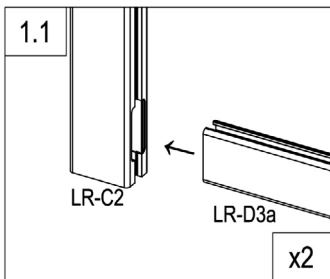
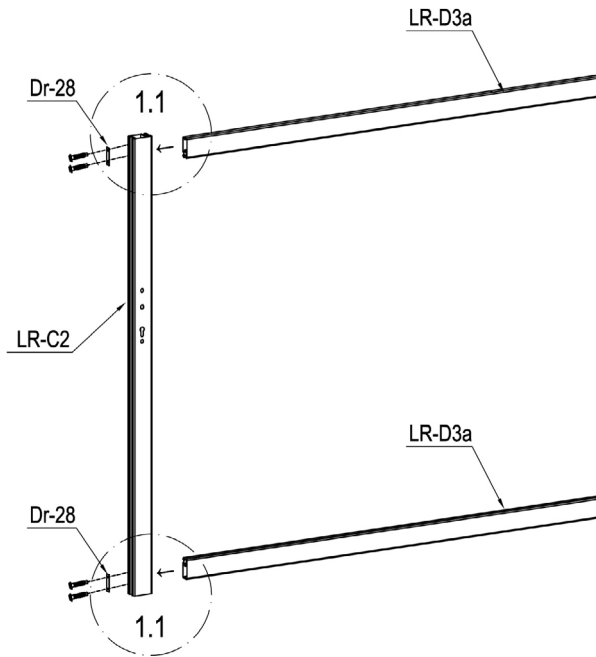

IMAGE	NO.	L.(mm)	QTY	IMAGE	NO.	L.(mm)	QTY
	LR-C1b	1728	2		Dr-14		1
	LR-C1c	1728	1		DO-30		4
	LR-C2	1728	1		AT-18		1
	AT-30	250	1		AT-18a		1
	AT-30a	250	1		ATW-14		1
	LR-D3a	1742	4		AT-19		4
	LR-F4	1555	16		AT-20		4
	LR-C4	1555	4		AT-21		1
	LR-F4a	1555	2		AT-22		1
	AT-B5b	1728	1		AT-23		2
	AT-D5	1603	1		Dr-18		1
	AT-B5a	550.5	1		Dr-19		1
	Dr-A5b	937	1		Dr-20a		1
	AT-29	193	2		Dr-21		1
	AT-B11	1728	4		Dr-22		1
	AT-A11a	250	2		Dr-25		1
	LR-D11	1742	4		Dr-25a		2
	AT-31	250	2		Dr-27		2
	LR-D6	25	8		Dr-28		6
	LR-C8	1555	4		AT-22J		7
	AT-B7a	1675	1		LR-T30	ST4x10	4
	LR-D14	1608	2		LR-T31	M8x60	10
	LR-D14a	1608	2		LR-T32	ST5.5x38	32
	LR-D16	1607	2		LR-T33	M8x130	4
	AT-16		1		LR-T34	ST4.8x38	12
	AT-B17	1412	5		LR-T35	ST4.2x19	50
	AT-17		2		LR-T36	M6x20	2
	AT-17a		2		LR-T37	M8x20	8
	AT-10		4		LR-T38	ST4x25	50
	Dr-13		1				

CASANOVO



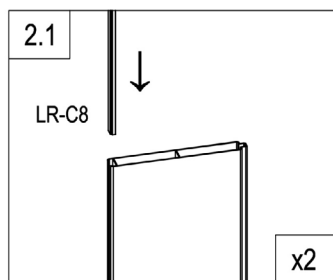
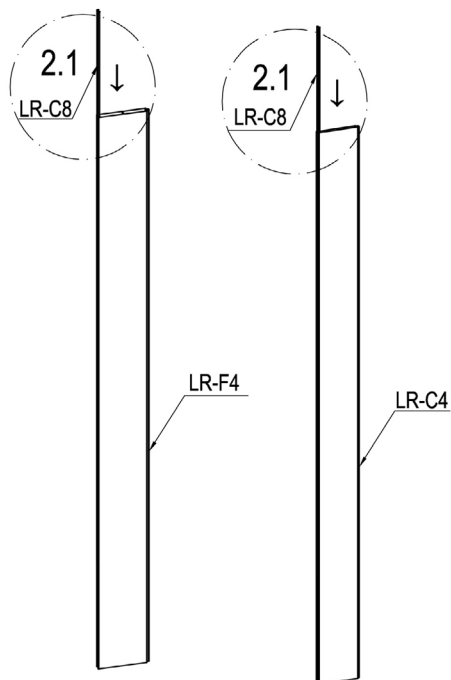

	LR-C2	1
	LR-D3a	2
	Dr-28	2
	LR-T32	4



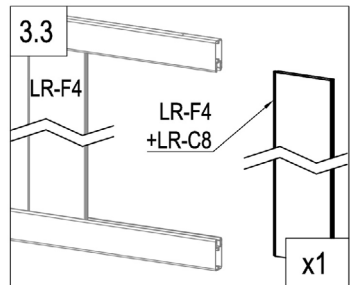
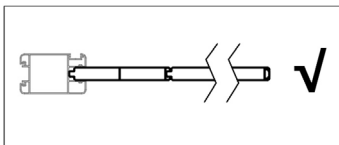
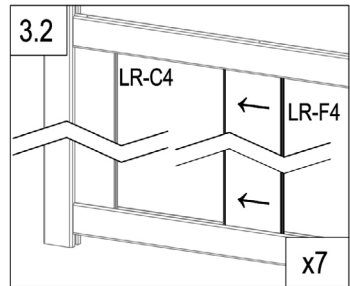
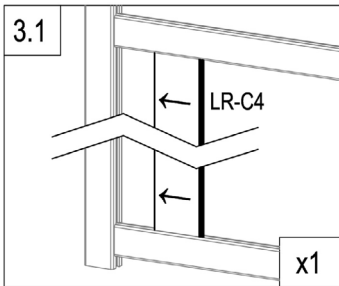
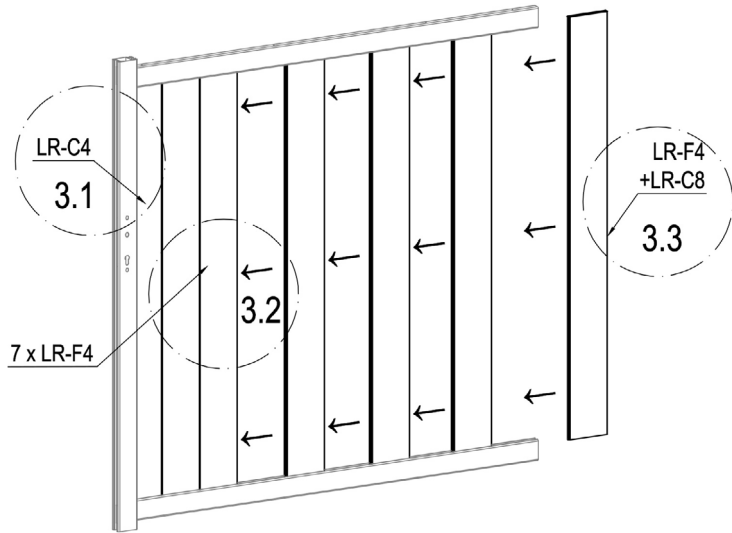

	LR-C8	2
	LR-F4	1
	LR-C4	1



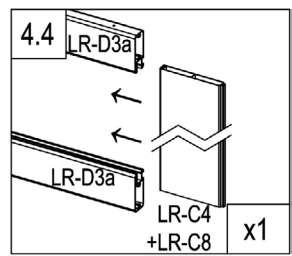
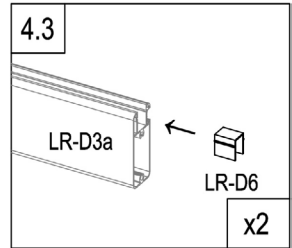
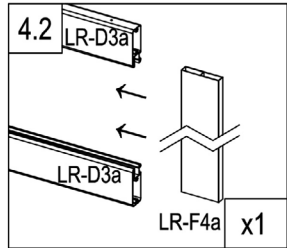
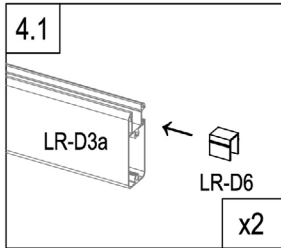
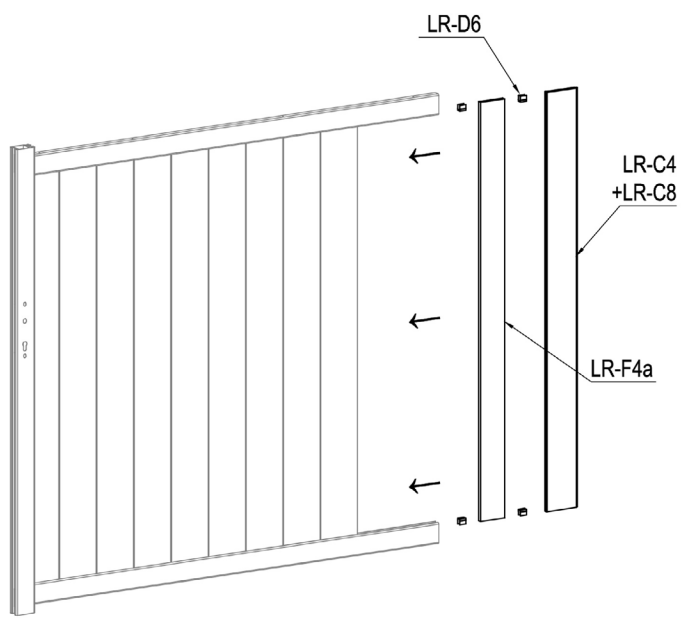

	LR-F4	7
	LR-C4	1



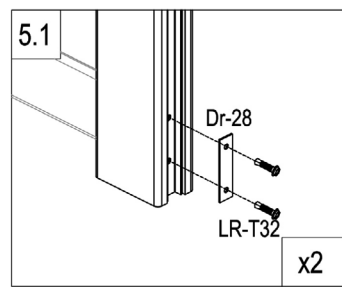
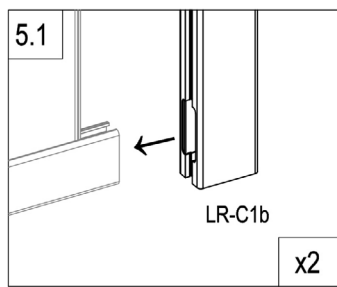
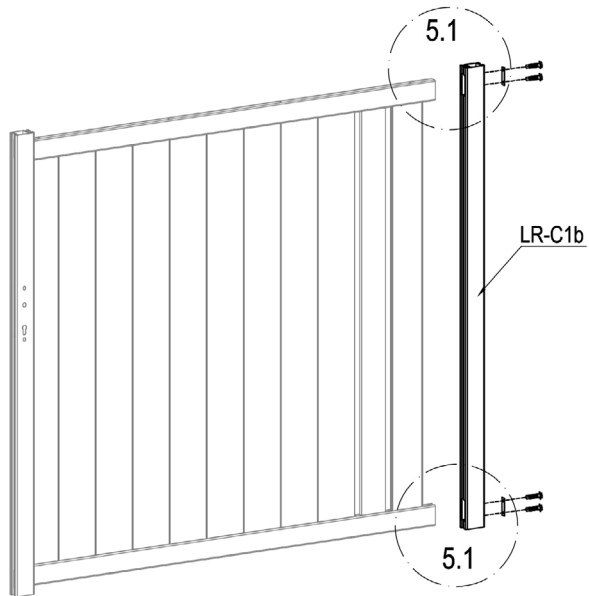

	LR-F4a	1
	LR-D6	4



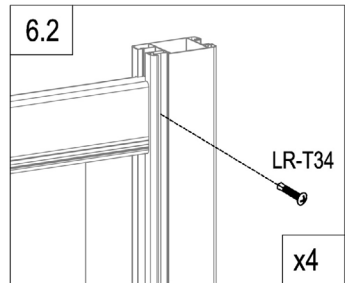
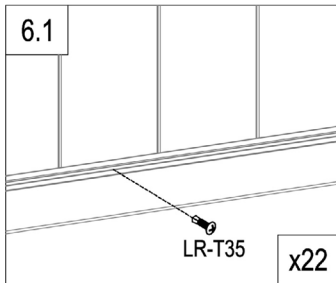
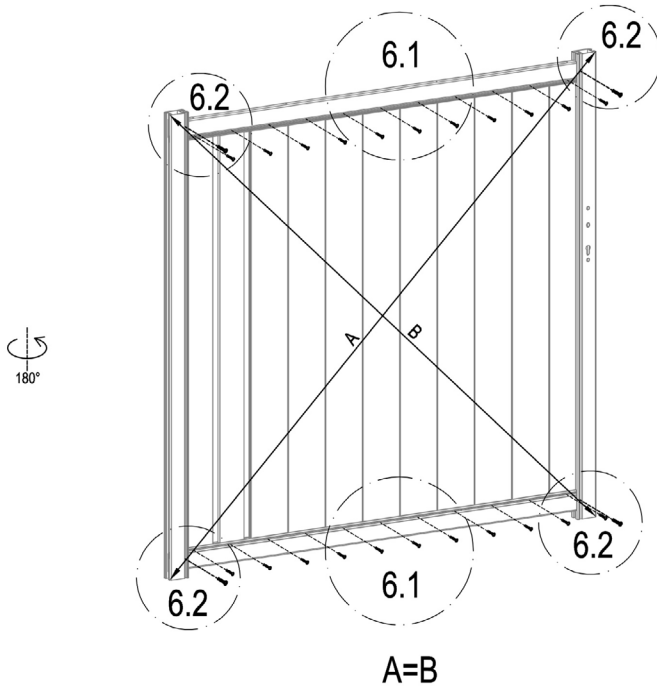

	LR-C1b	1
	Dr-28	2
	LR-T32	4

CASANOVO



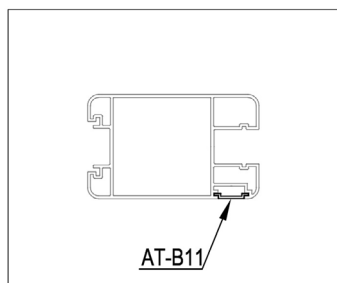
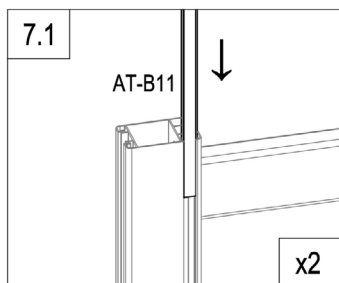
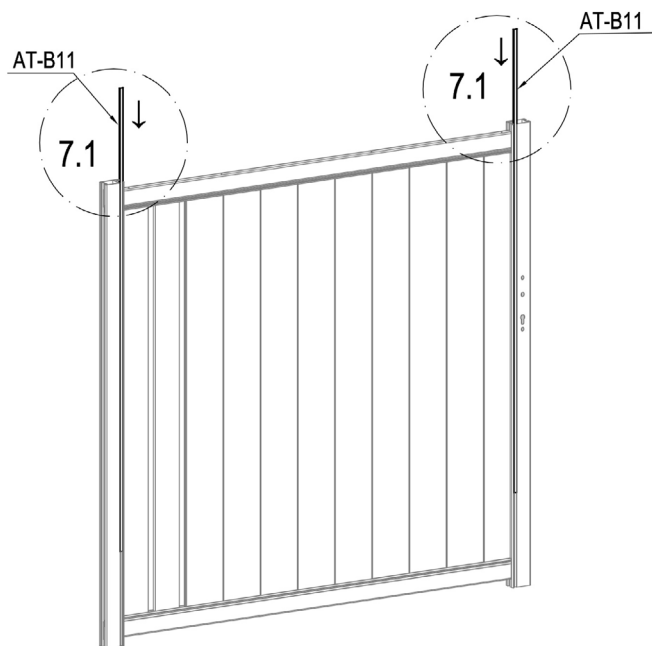

	LR-T35	22
	LR-T34	4

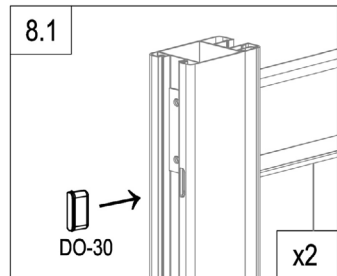
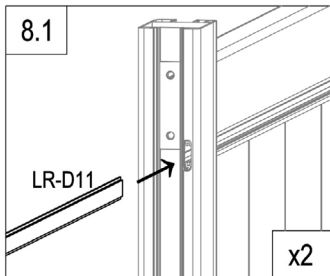
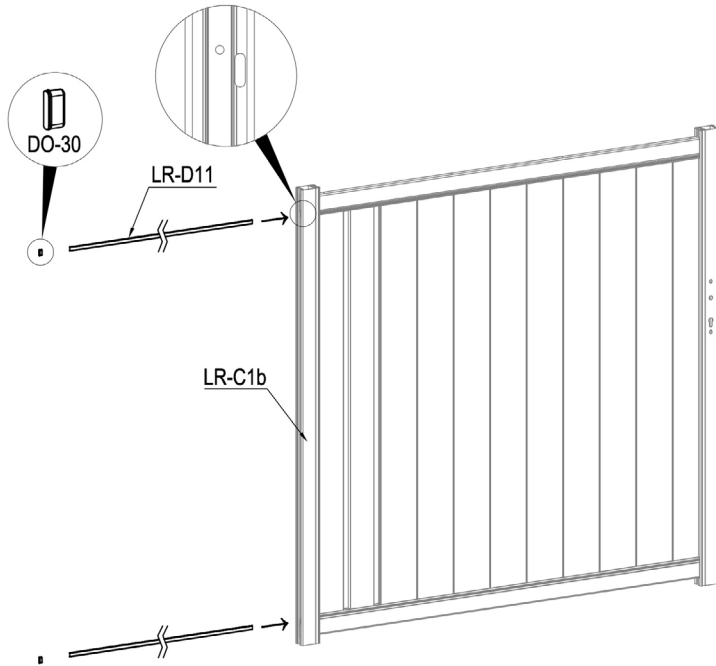

	AT-B11	2
---	--------	---



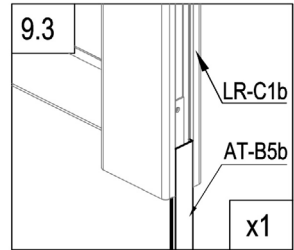
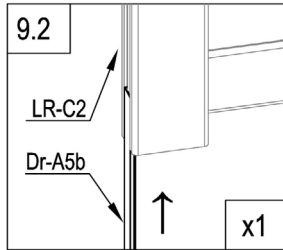
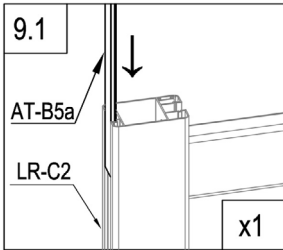
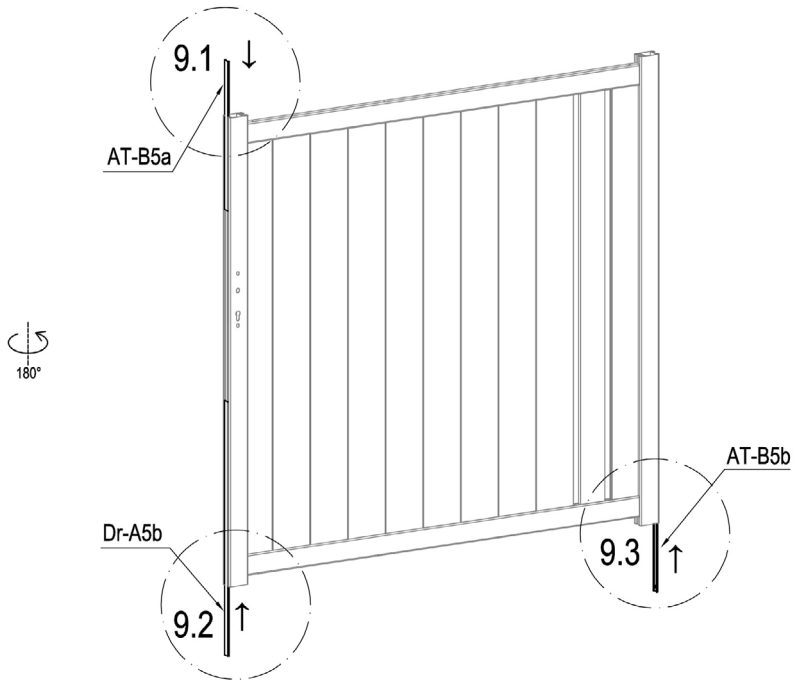

	LR-D11	2
	DO-30	2



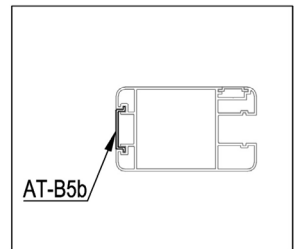

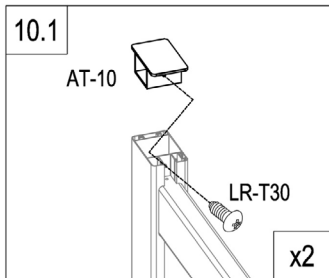
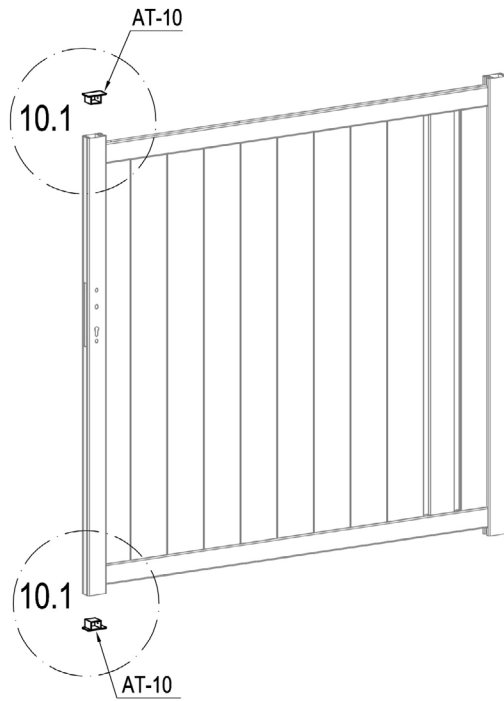

	AT-B5b	1
	AT-B5a	1
	Dr-A5b	1



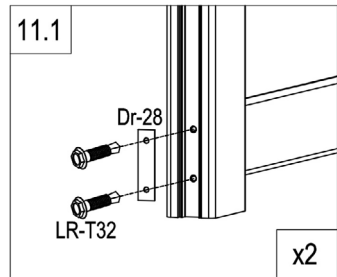
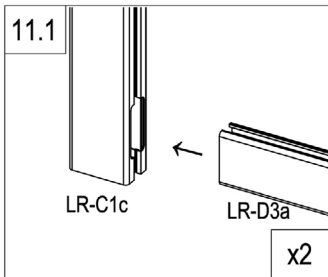
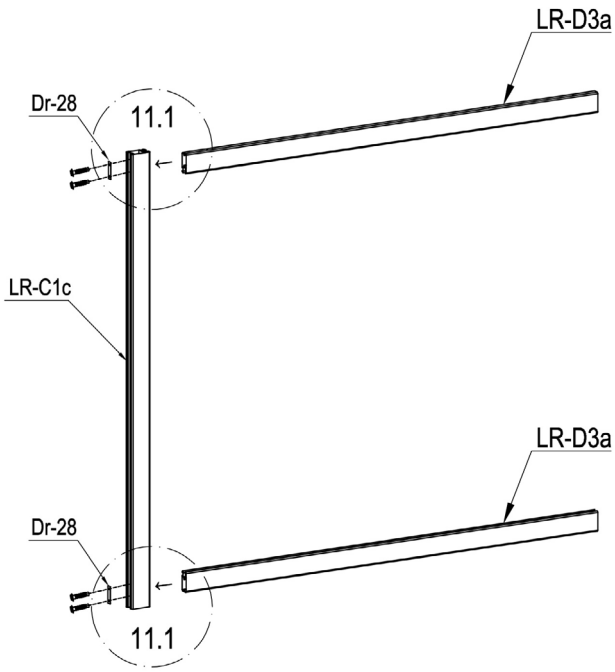





	AT-10	2
	LR-T30	2

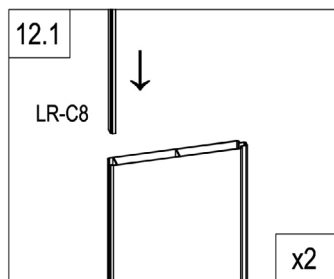
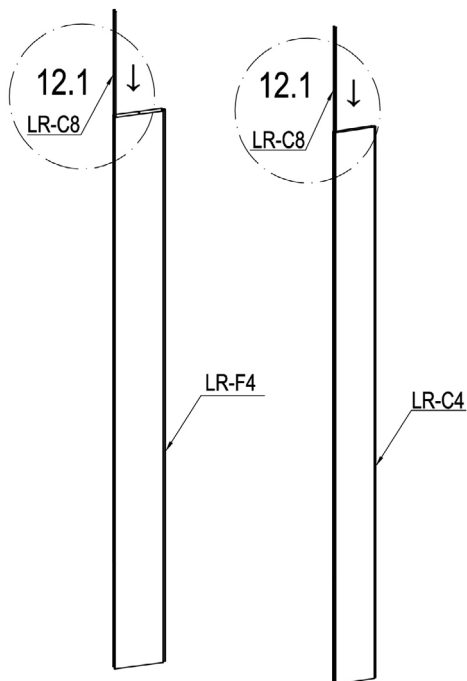



	LR-C1c	1
	LR-D3a	2
	Dr-28	2
	LR-T32	4



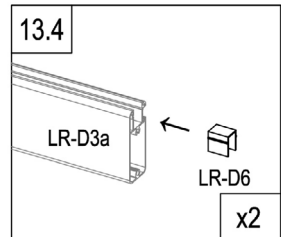
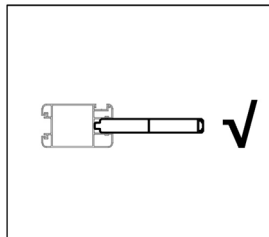
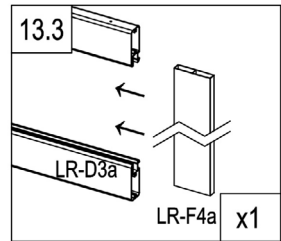
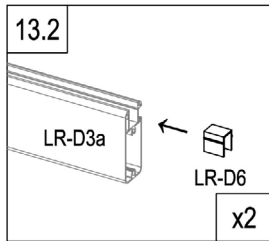
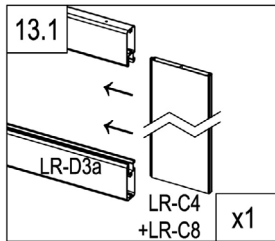
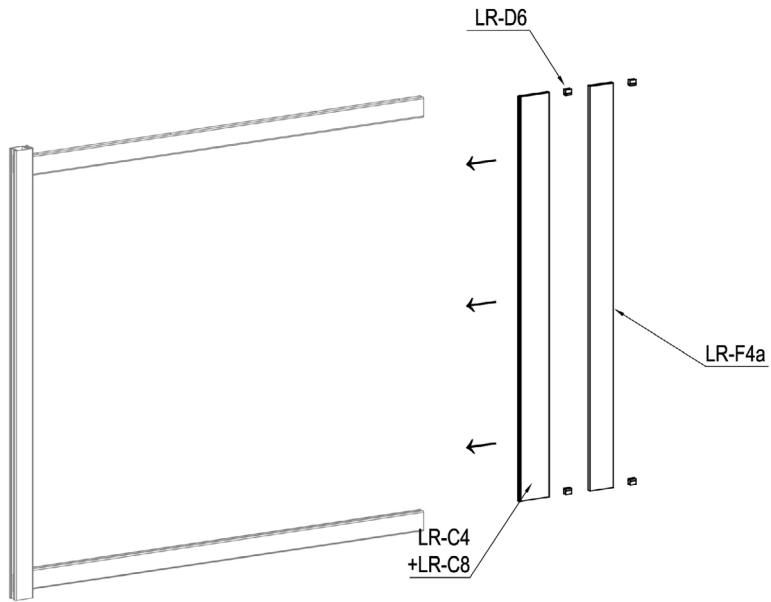

	LR-C8	2
	LR-F4	1
	LR-C4	1



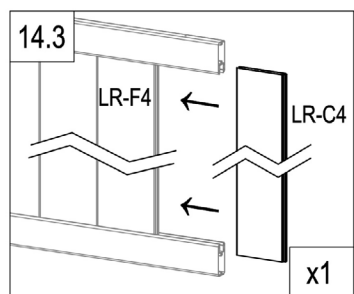
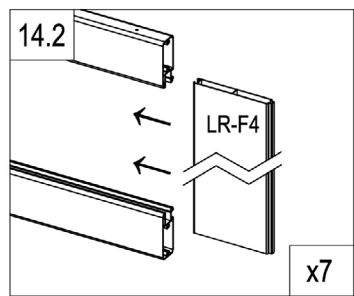
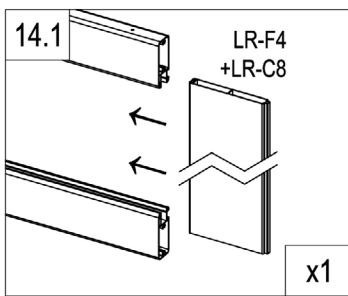
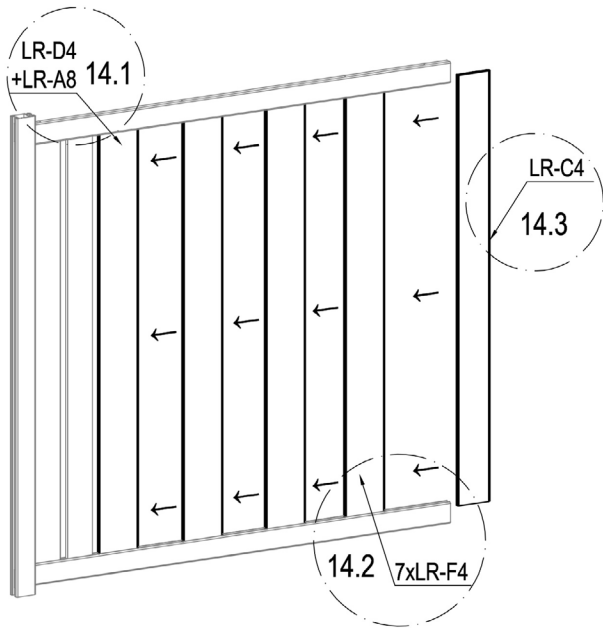

	LR-F4a	1
	LR-D6	4

CASANOVO



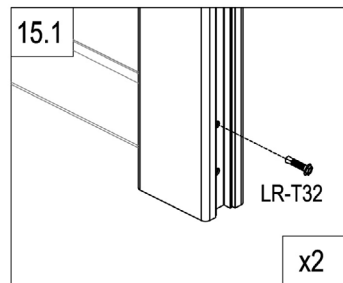
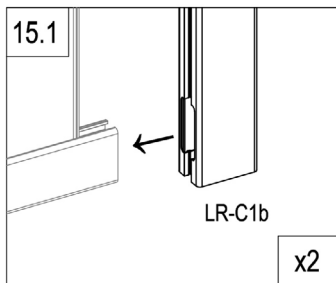
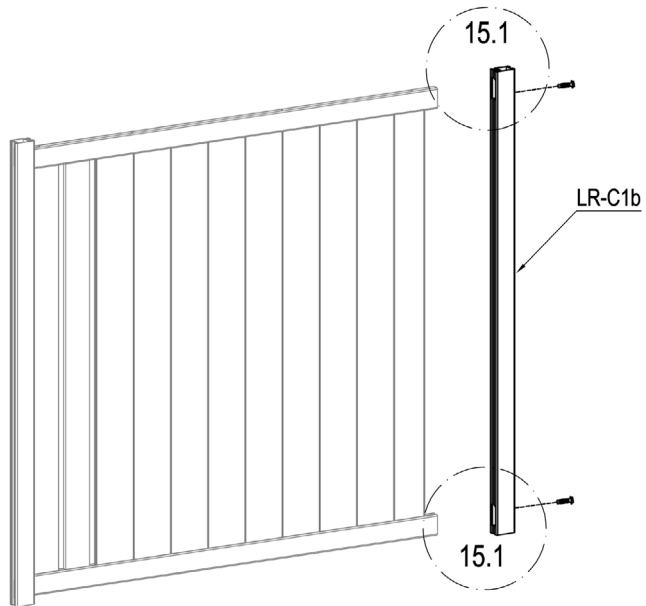

	LR-F4	7
	LR-C4	1

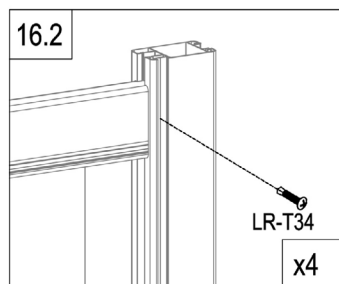
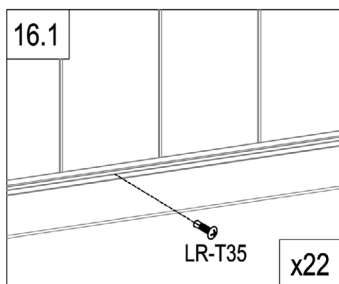
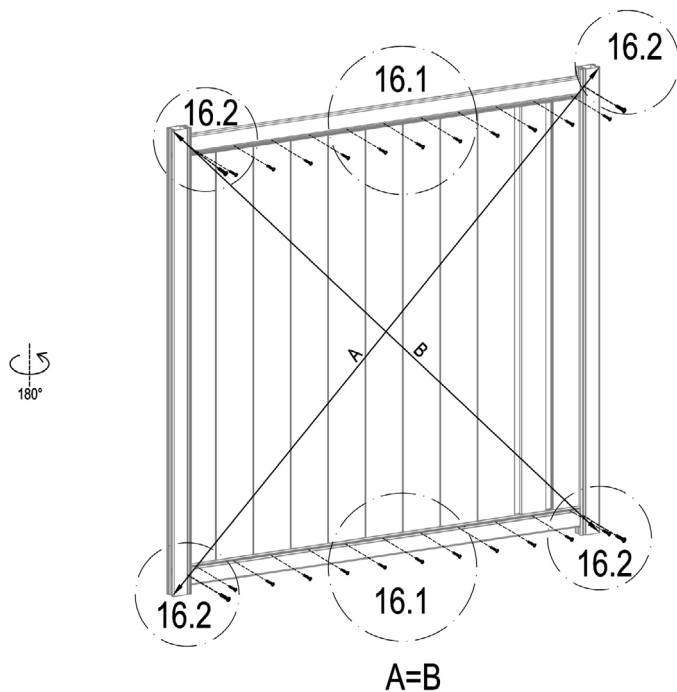

	LR-C1b	1
	LR-T32	2



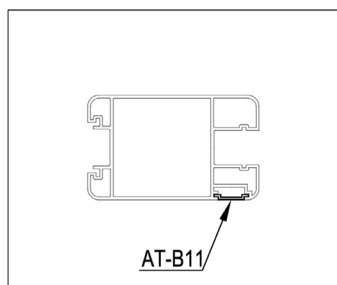
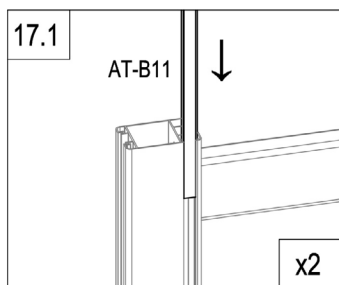
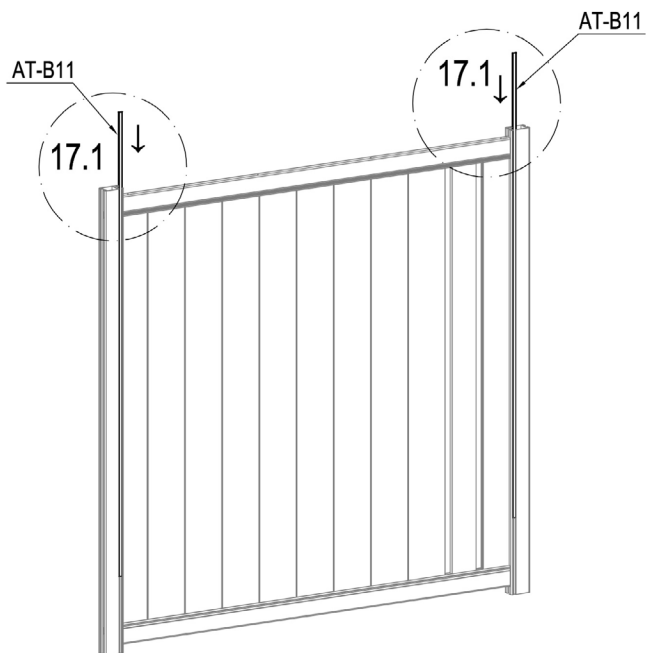

	LR-T35	22
	LR-T34	4

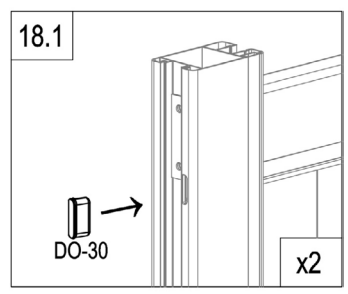
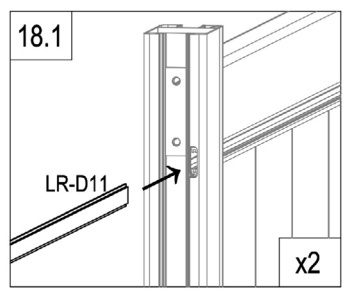
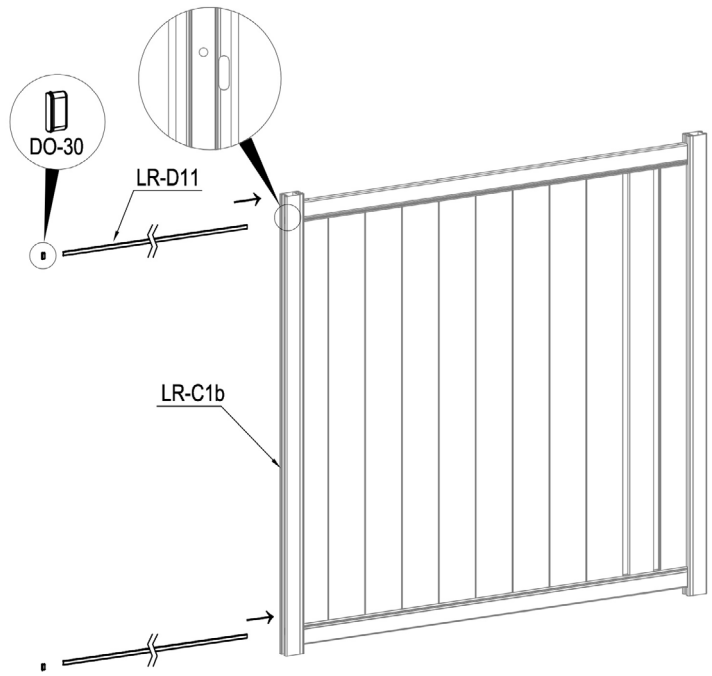

	AT-B11	2
---	--------	---



	LR-D11	2
	DO-30	2

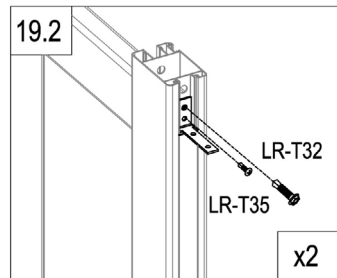
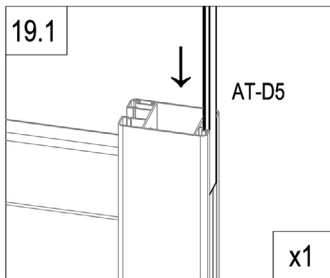
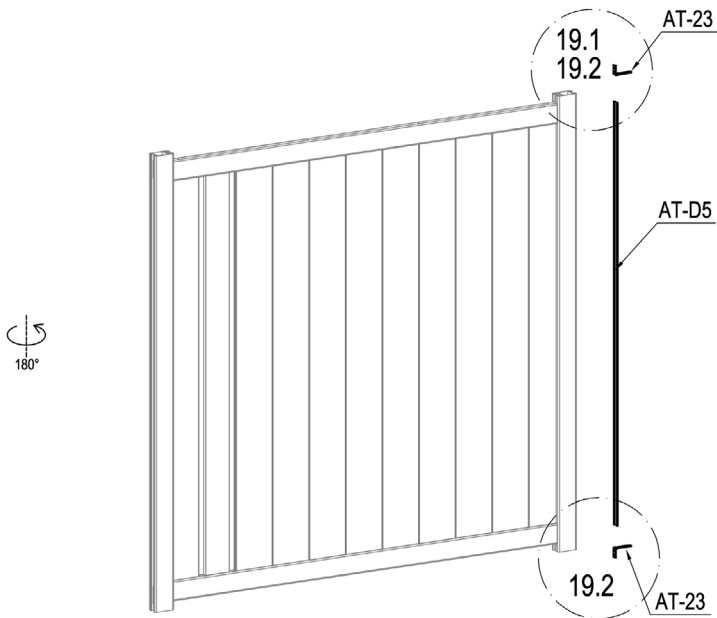



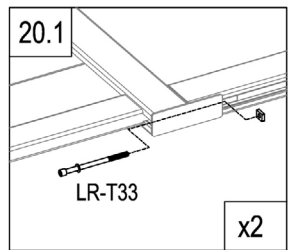
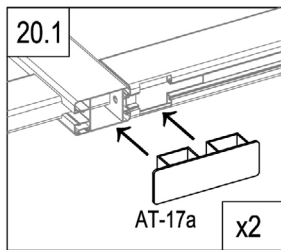
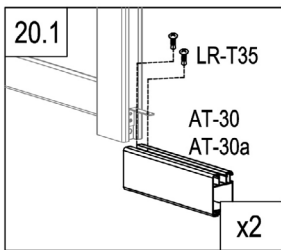
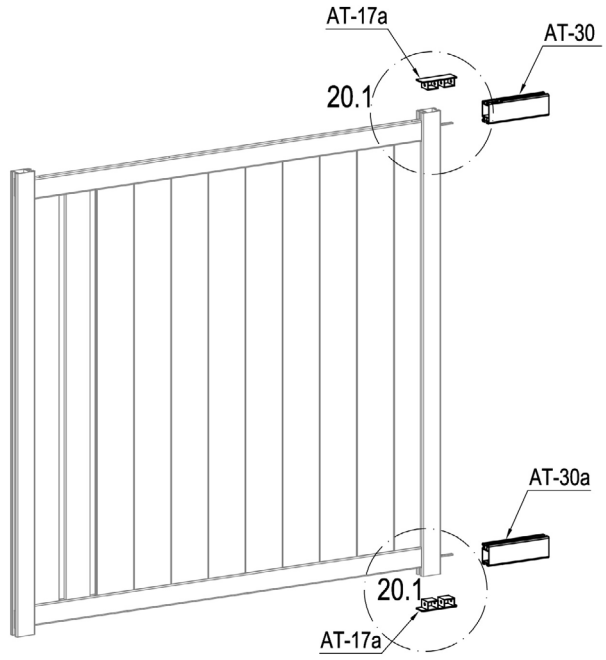

	AT-D5	1
	AT-23	2
	LR-T32	2
	LR-T35	2



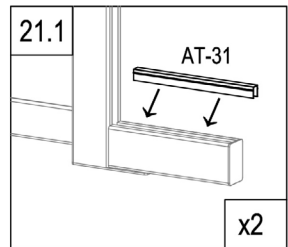
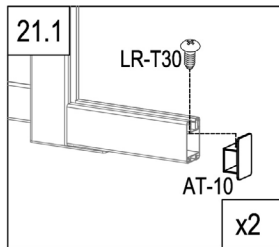
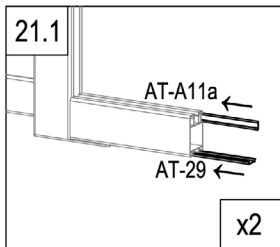
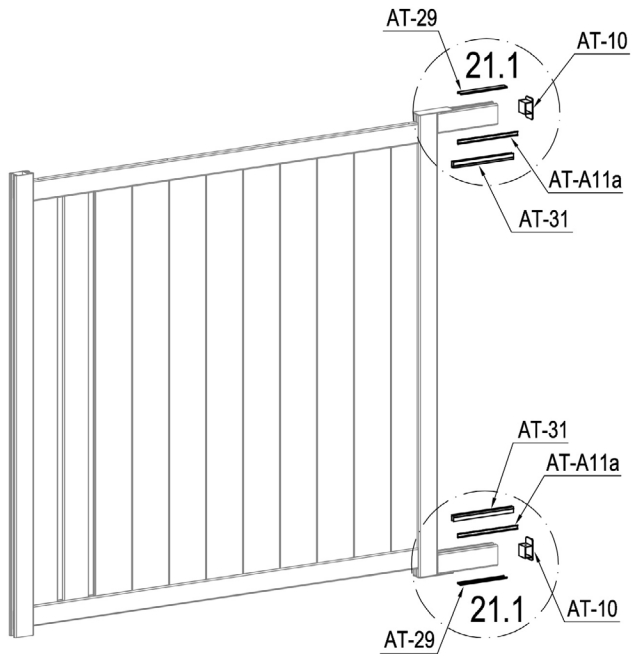

	AT-30	1
	AT-30a	1
	AT-17a	2



	LR-T33	2
	LR-T35	4



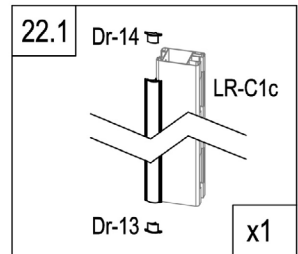
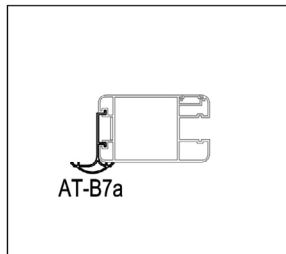
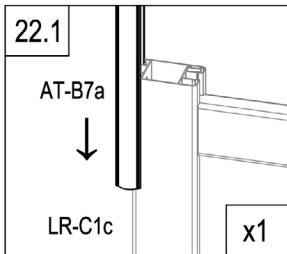
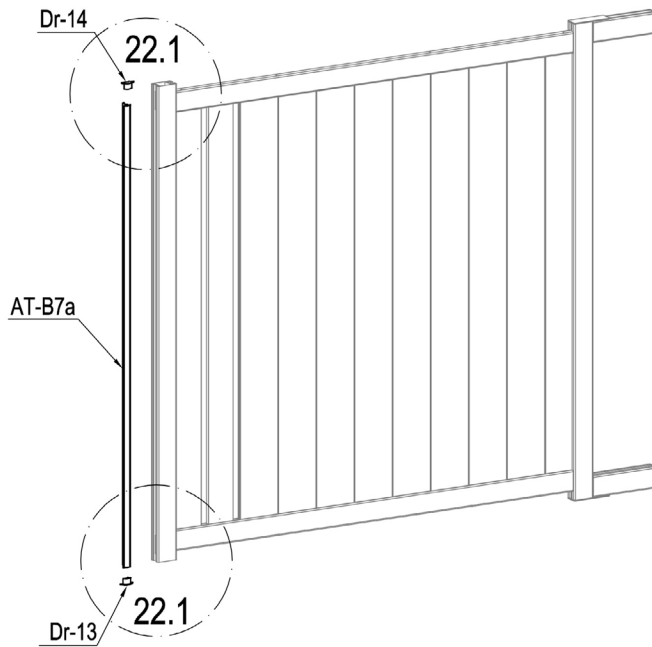

	AT-29	2
	AT-A11a	2
	AT-31	2

	AT-10	2
	LR-T30	2

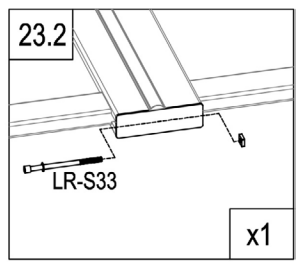
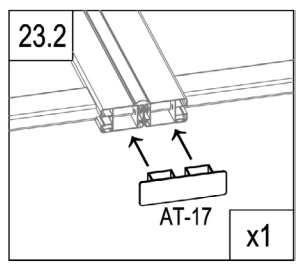
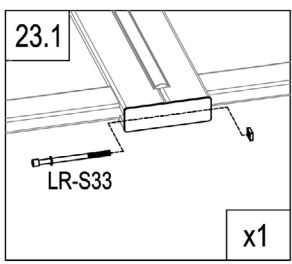
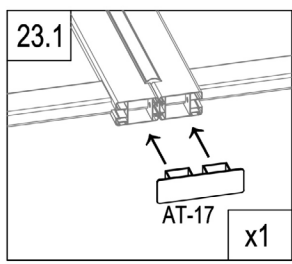
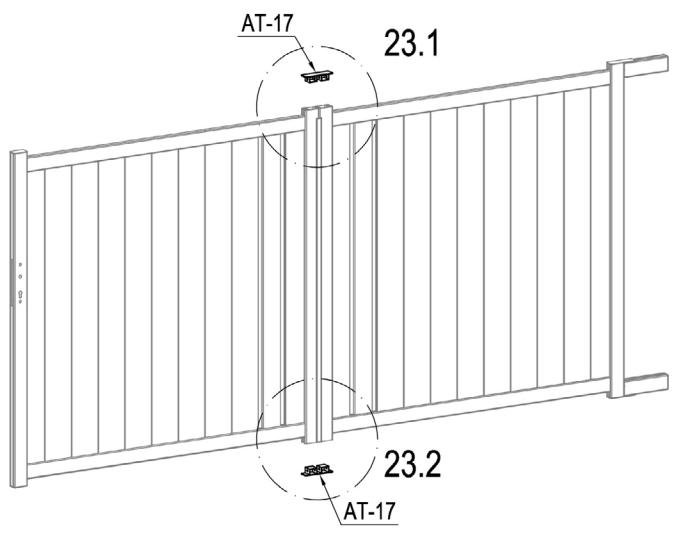

	AT-B7a	1
	Dr-13	1
	Dr-14	1



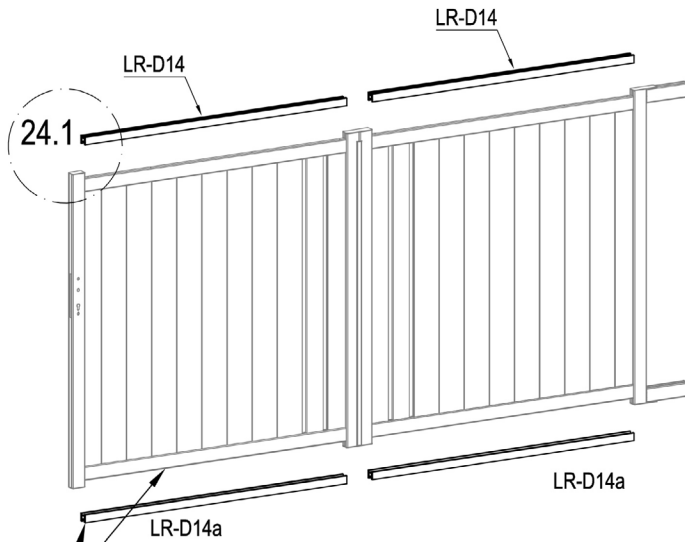

	AT-17	2
	LR-T33	2



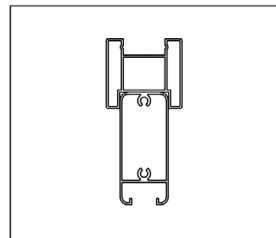
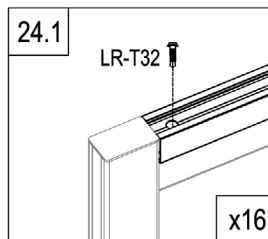
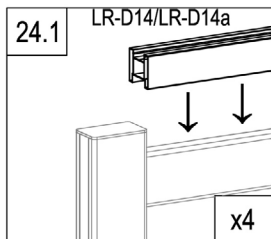

EN: These parts are made for connecting your gate's automation
 FR: Ces pièces sont faites pour relier l'automatisation de votre portail
 DE: Diese Teile sind für den Anschluss der Automatisierung Ihres Tores vorgesehen
 ES: Estas piezas están hechas para conectar la automatización de su puerta
 PT: Estas peças são feitas para ligar a automatização do seu portão
 IT: Queste parti sono realizzate per collegare l'automazione del vostro cancello
 NL: Deze onderdelen zijn gemaakt voor het aansluiten van de automatisering van uw poort.
 PL: Te części są wykonane do podłączenia automatyki bramy.



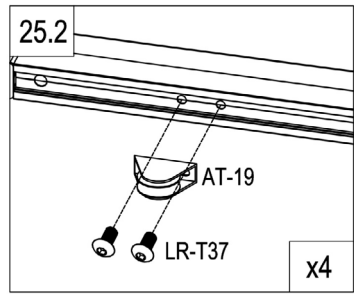
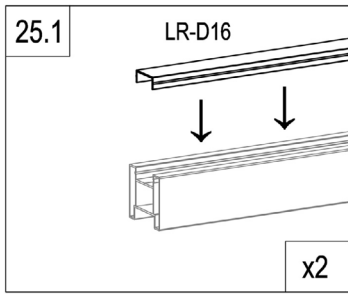
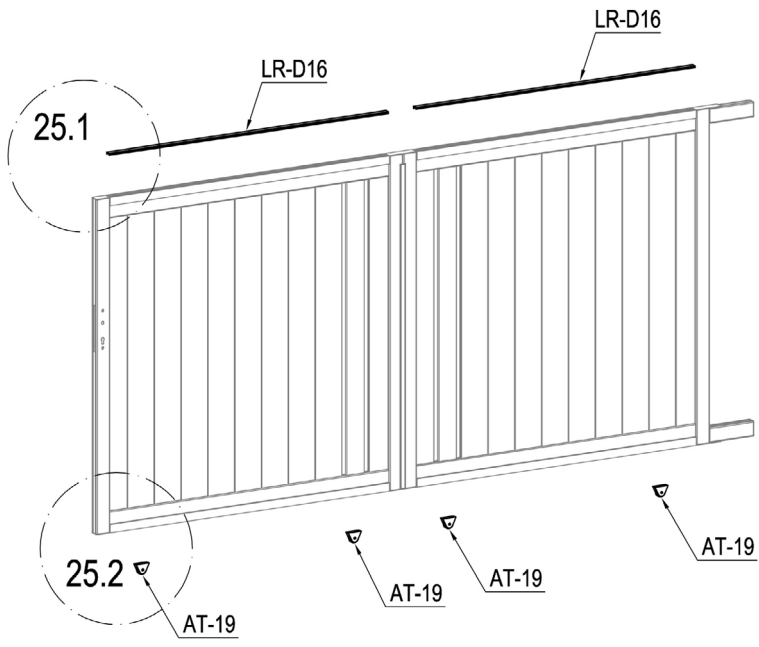

	LR-D14	2
	LR-D14a	2
	LR-T32	16

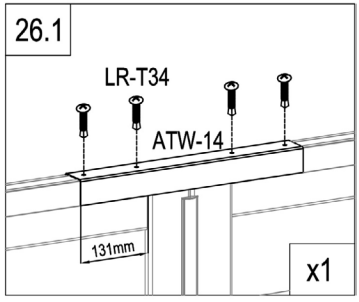
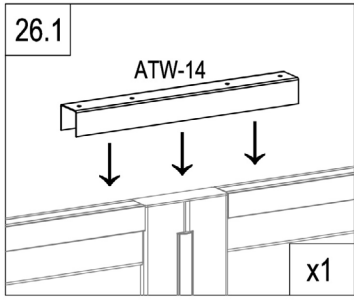
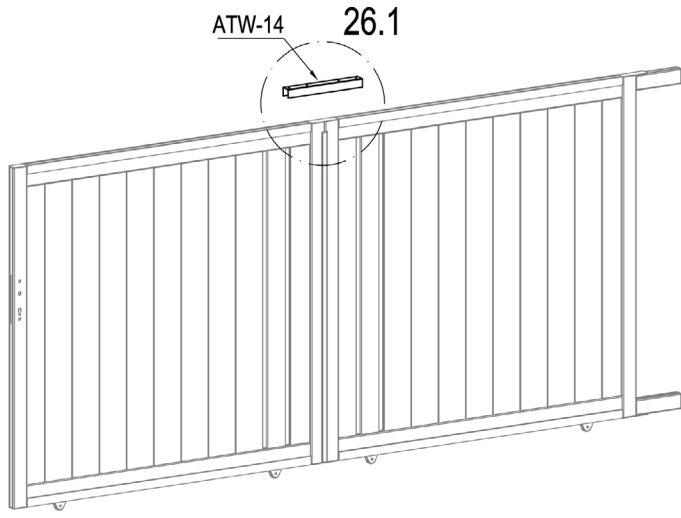

	LR-D16	2
	AT-19	4
	LR-T37	8



	ATW-14	1
	LR-T34	4

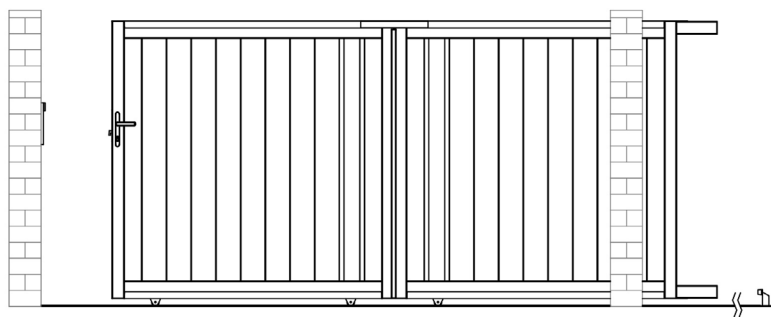

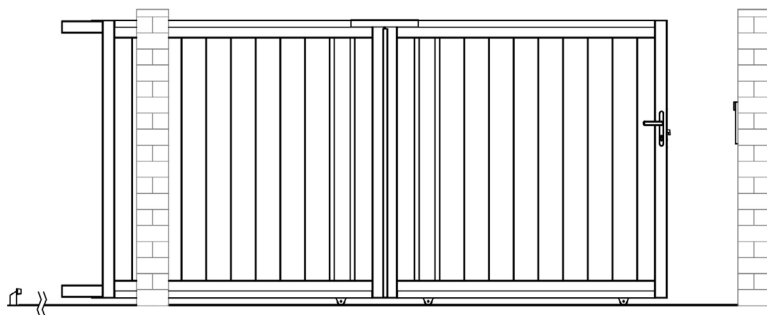

L

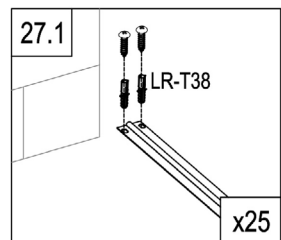
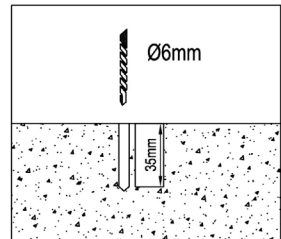
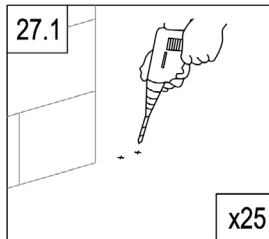
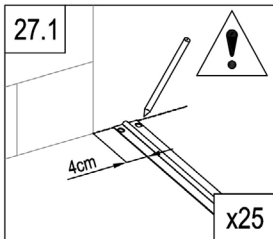
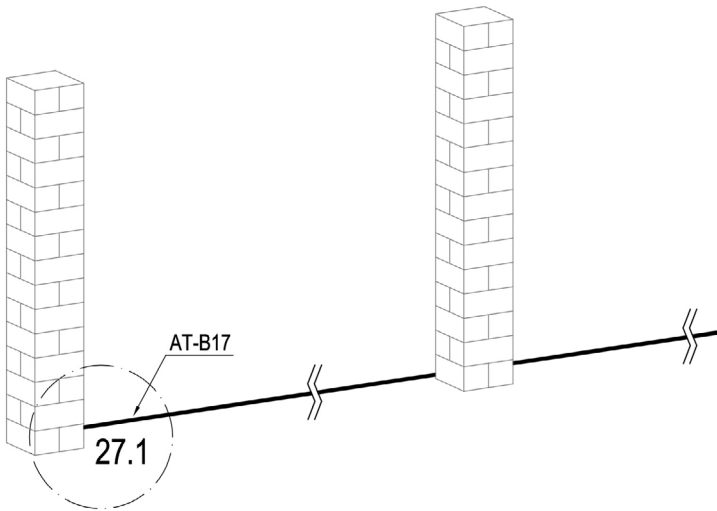

R

L



	AT-B17	5
	LR-T38	50

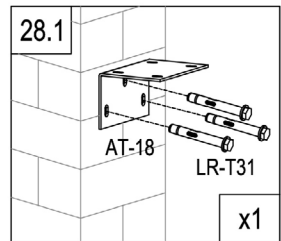
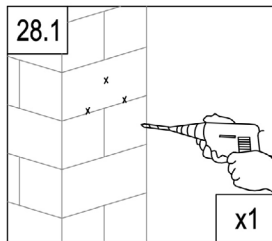
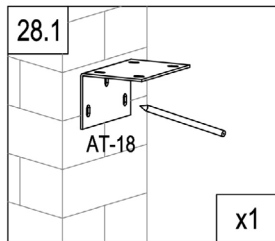
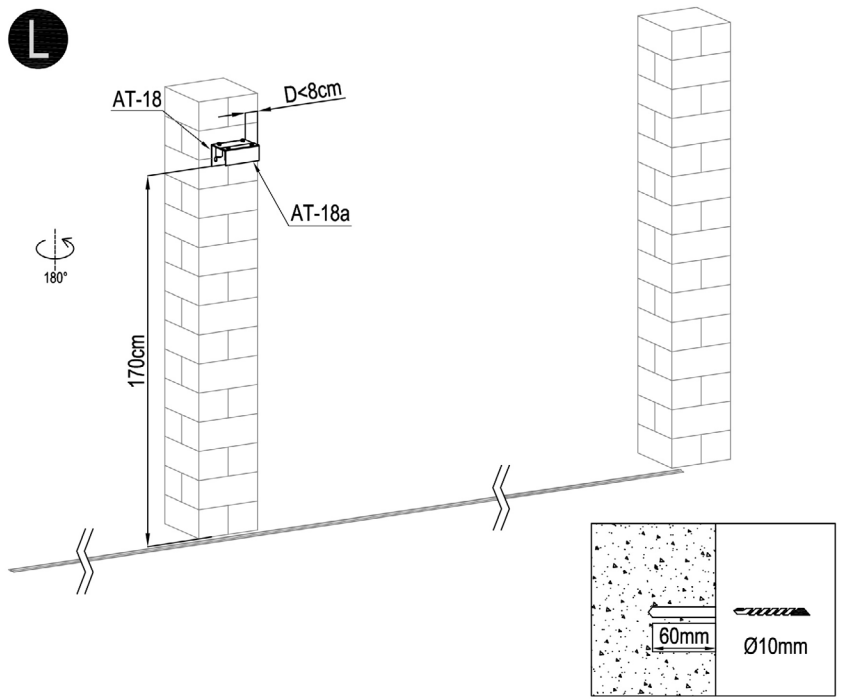

	AT-18	1
	AT-18a	1
	AT-20	4
	LR-T31	3

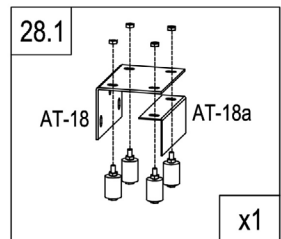
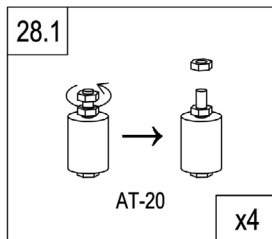

L

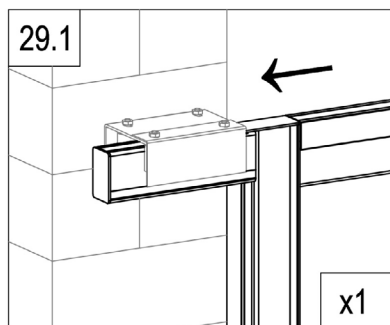
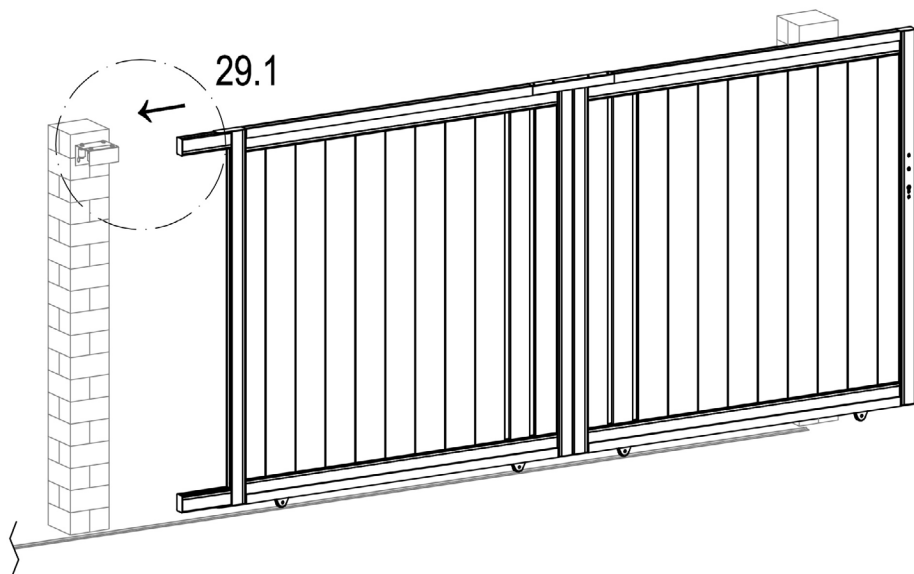

L

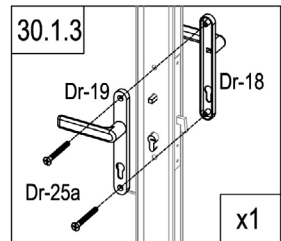
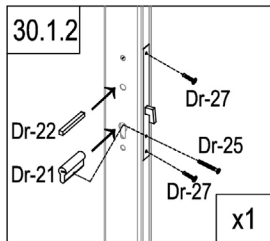
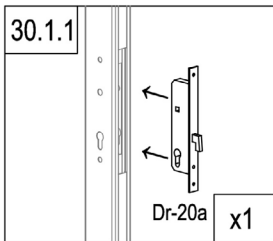
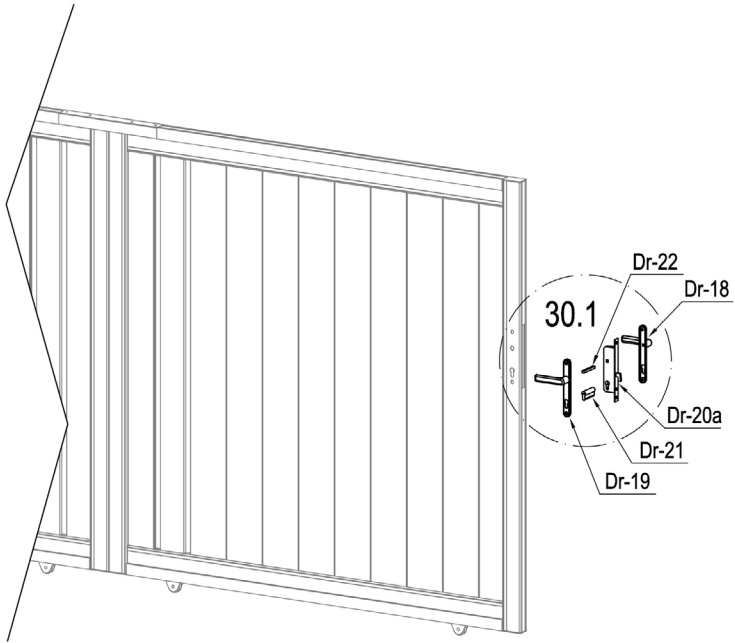

	Dr-20a	1
	Dr-21	1
	Dr-22	1
	Dr-25	1

	Dr-18	1
	Dr-19	1
	Dr-25a	2
	Dr-27	2

L

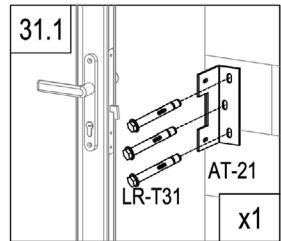
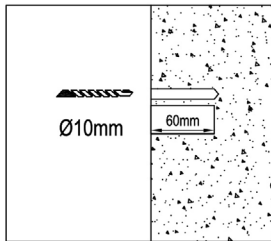
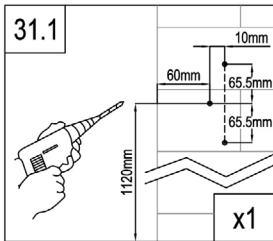
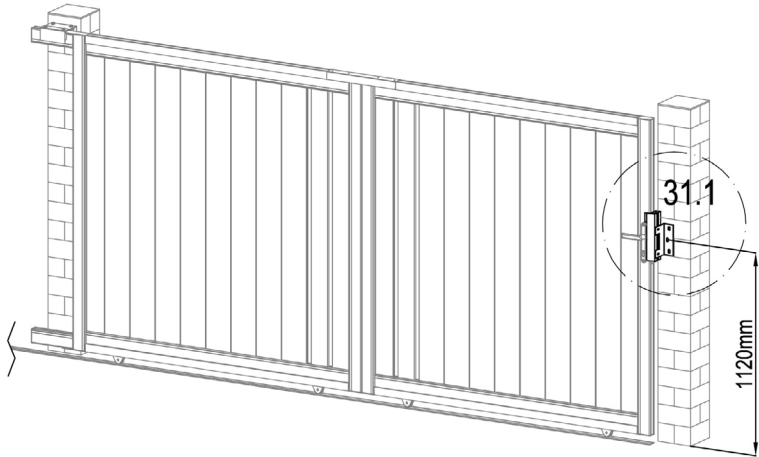

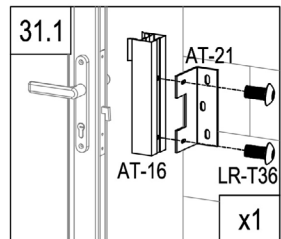
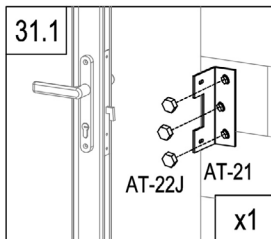

	AT-16	1
	AT-21	1
	LR-T36	2
	LR-T31	3
	AT-22J	3

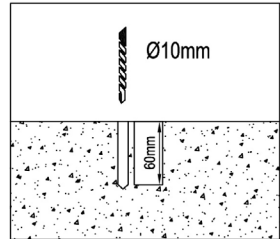
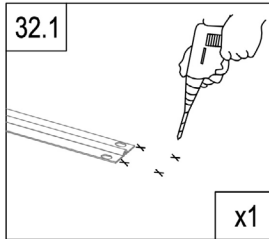
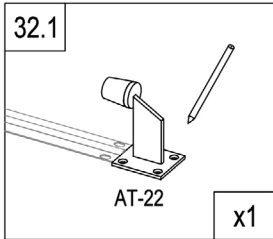
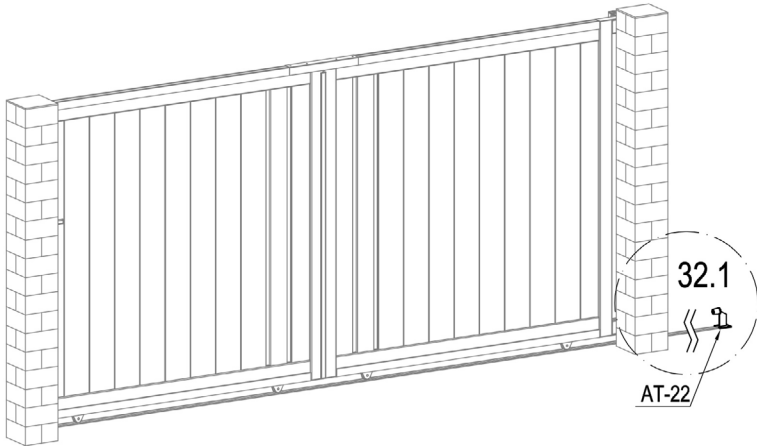

L



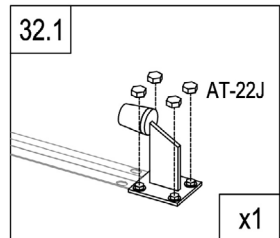
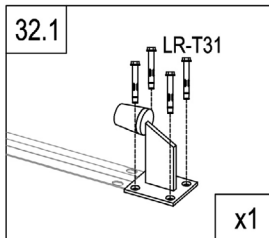

	AT-22	1
	LR-T31	4
	AT-22J	4

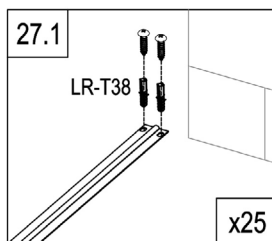
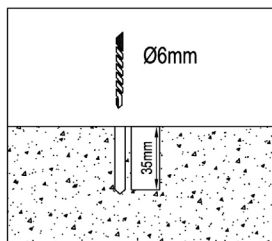
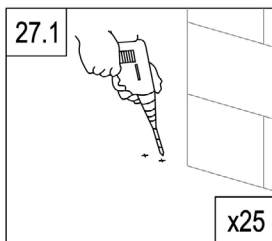
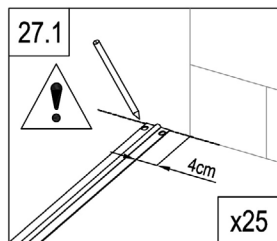
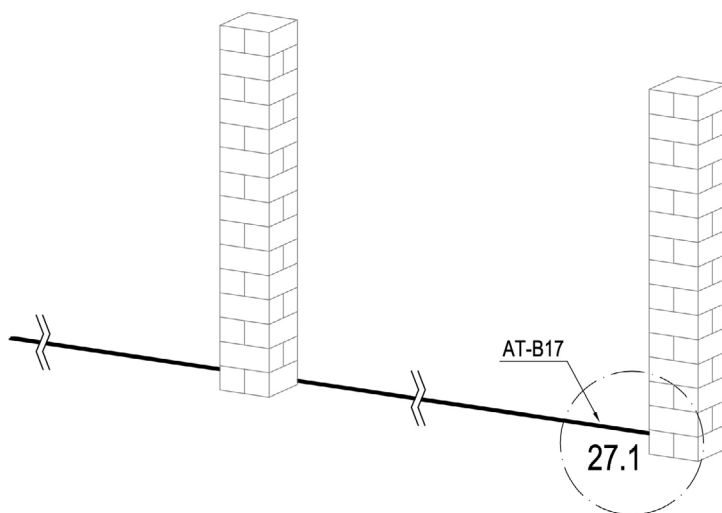

R



	AT-B17	5
	LR-T38	50

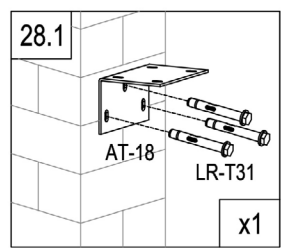
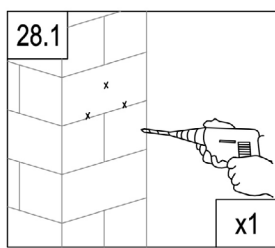
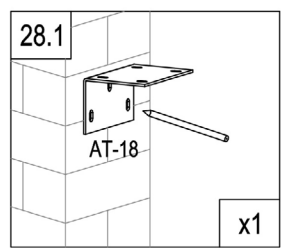
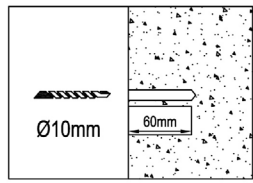
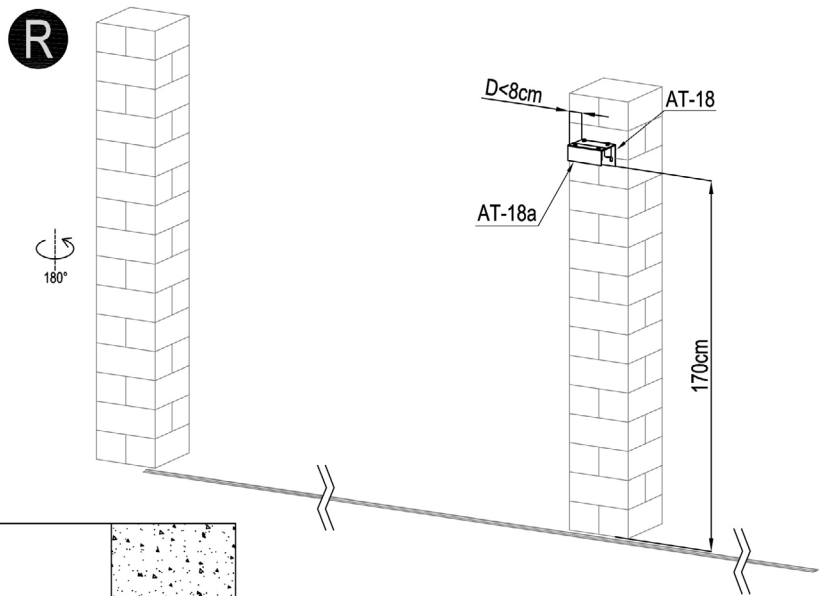

	AT-18	1
	AT-18a	1
	AT-20	4
	LR-T31	3

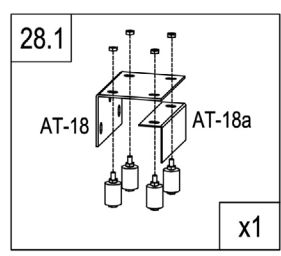
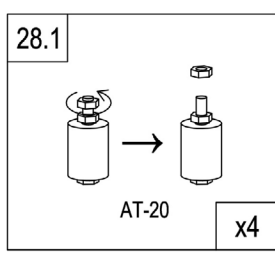

R

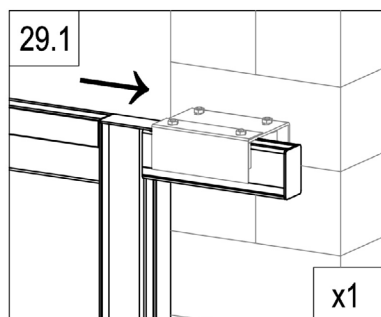
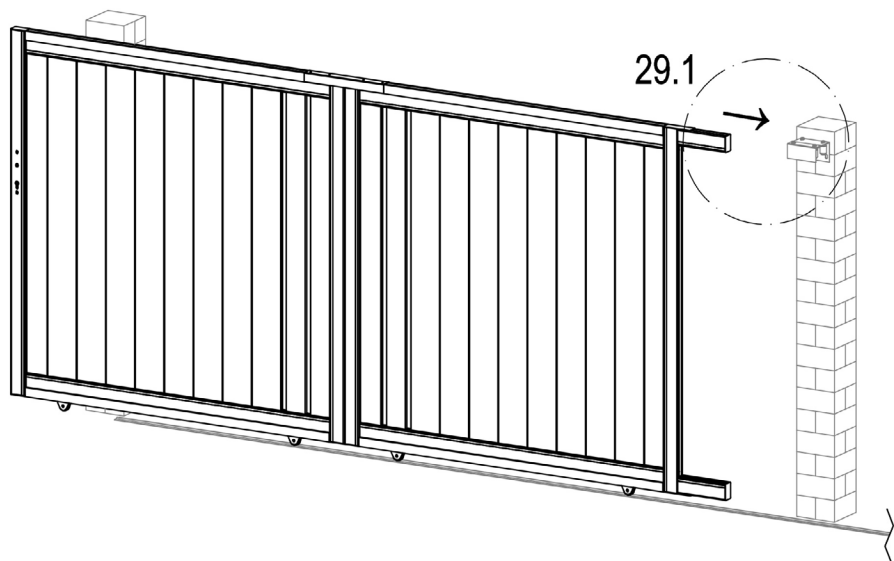

R

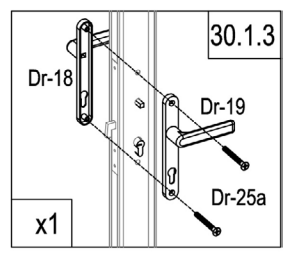
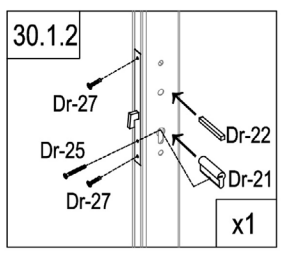
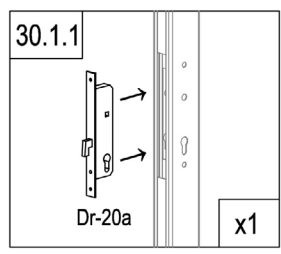
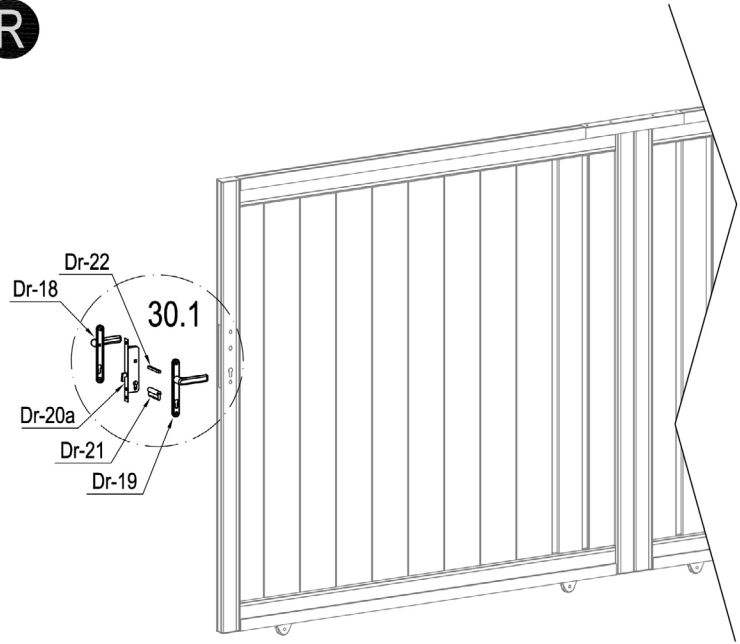

	Dr-20a	1
	Dr-21	1
	Dr-22	1
	Dr-25	1

	Dr-18	1
	Dr-19	1
	Dr-25a	2
	Dr-27	2

R

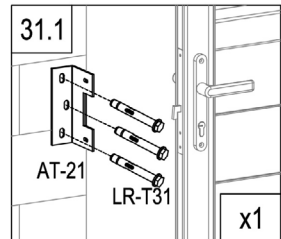
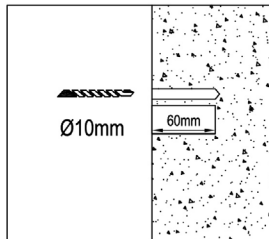
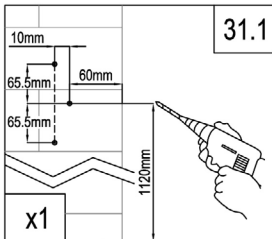
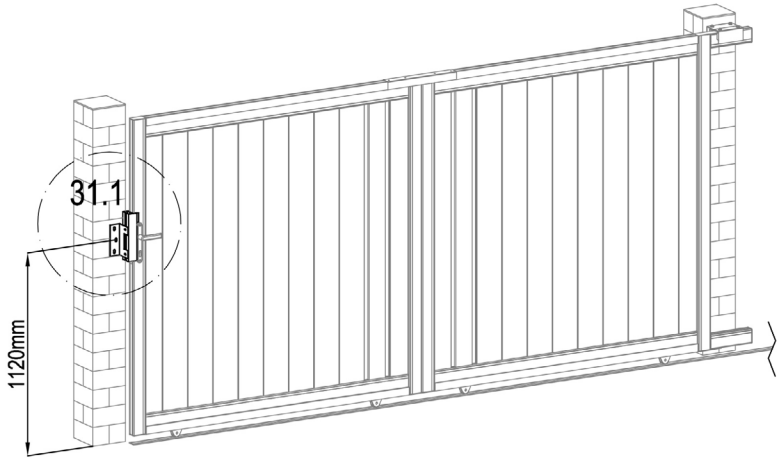

	AT-16	1
	AT-21	1
	LR-T36	2
	LR-T31	3
	AT-22J	3

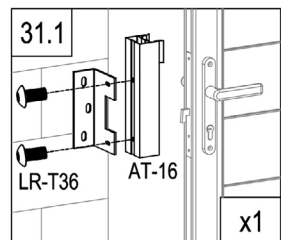
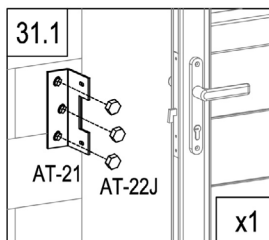

R

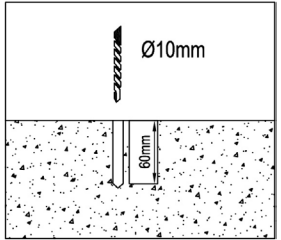
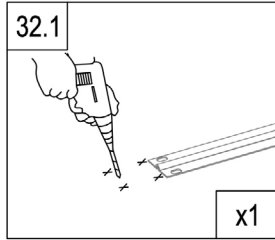
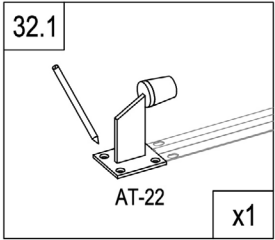
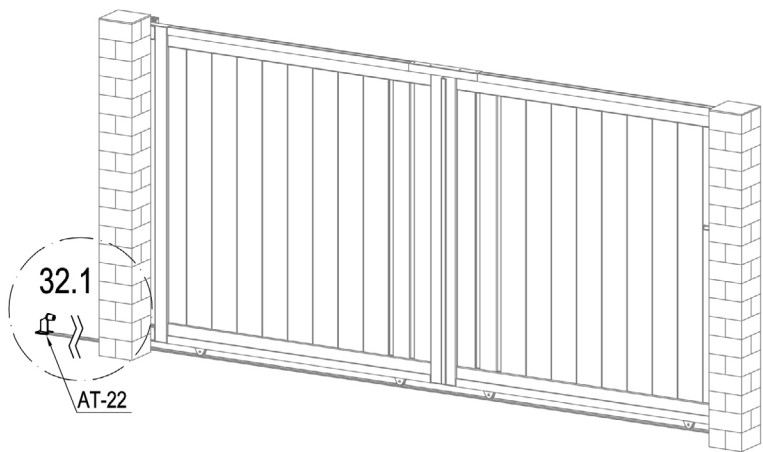

	AT-22	1
	LR-T31	4
	AT-22J	4

