

CASANOVO

GIONA 300C180

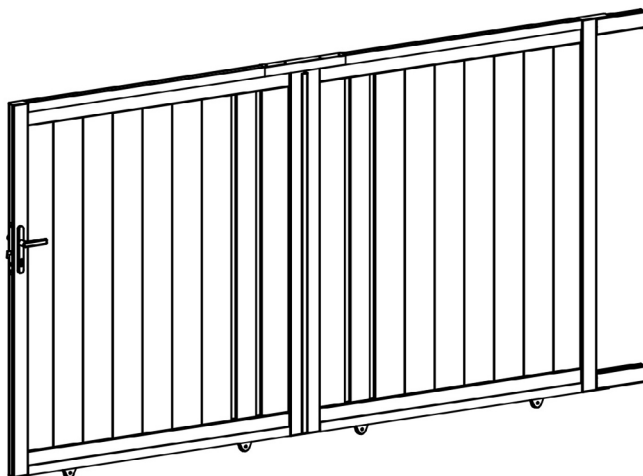

COM-001145 [x1]

COM-001147 [x1]

COM-001146 [x1]



7-8H



X 2



INSTRUCTION MANUAL / NOTICE DE MONTAGE / MONTAGEANLEITUNG / MANUAL DE MONTAJE / MANUAL DE MONTAGEM / MANUALE DI MONTAGGIO /
MONTAGEHANDLEIDING / INSTRUKCJA MONTAŻU / KÄYTTÖOHJEET / BRUKSANVISNING / BRUGSANVISNING / INSTRUCCIUNI DE ASAMBLARE /
NAVODILA ZA SESTAVLJANJE / NÁVOD NA MONTÁŽ / ÖSSZESZERELÉSI ÚTMUTATÓ / NÁVOD K MONTÁŽI / UPUTE ZA INSTALACIJU /
ΟΔΗΓΙΕΣ ΣΥΝΑΡΜΟΛΟΓΗΣΗΣ / SURINKIMO INSTRUKCIJOS / MONTŽAS INSTRUKCIJAS

Ext.

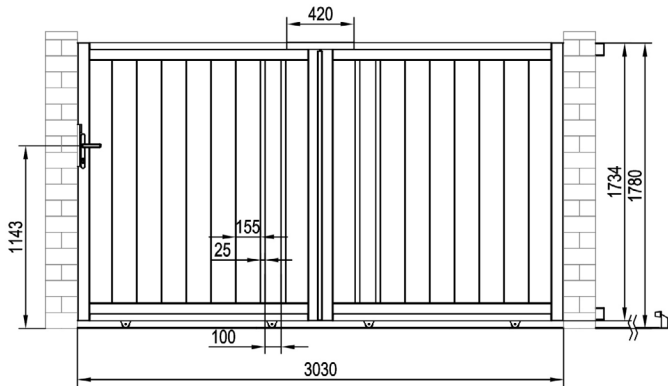

Int.

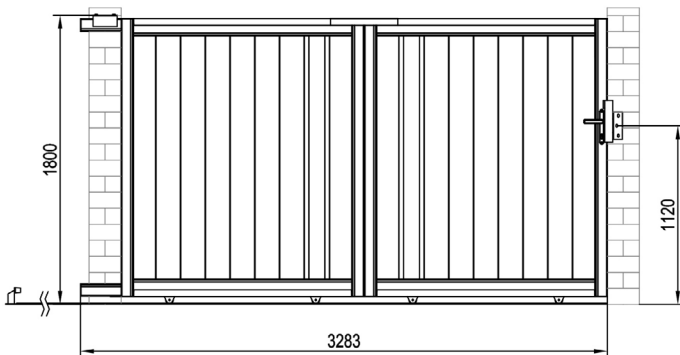

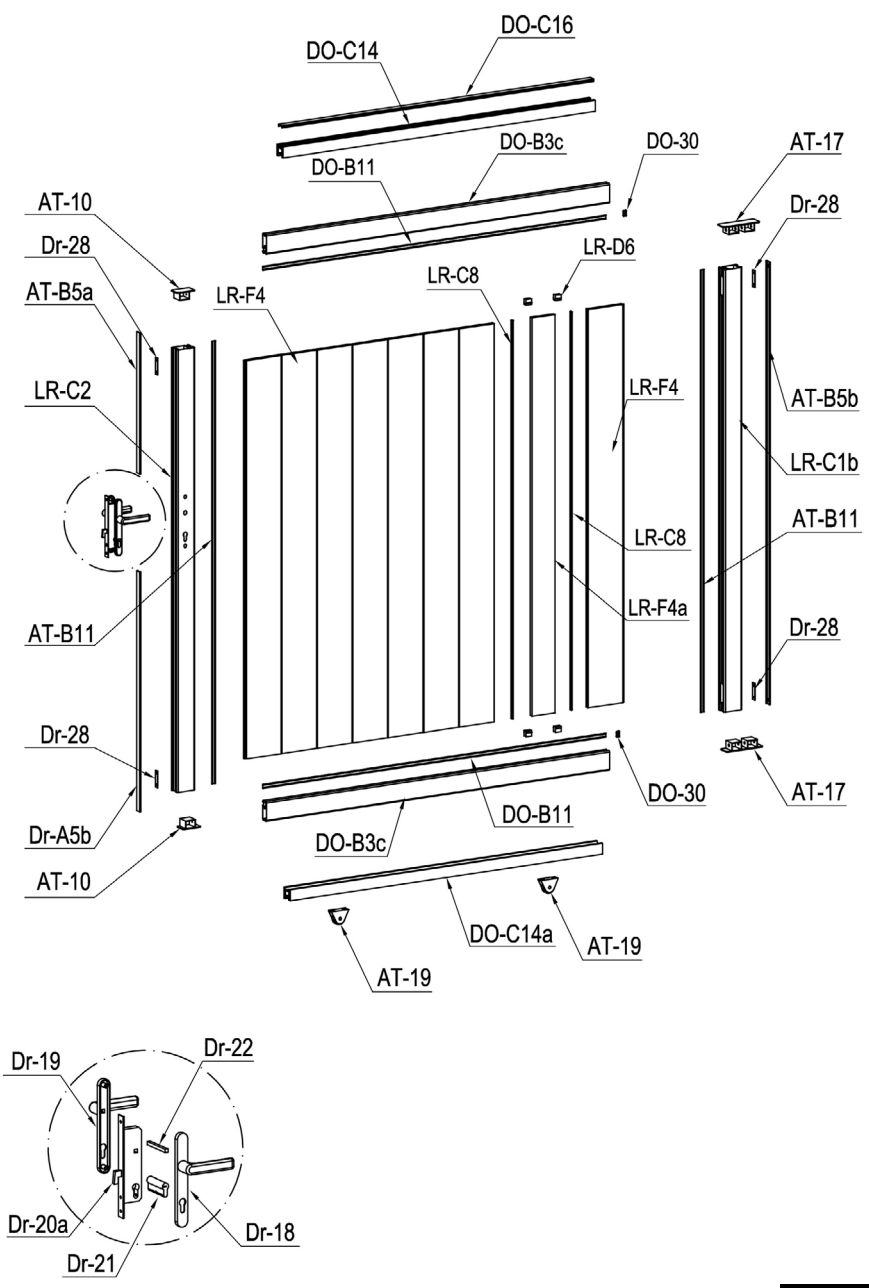

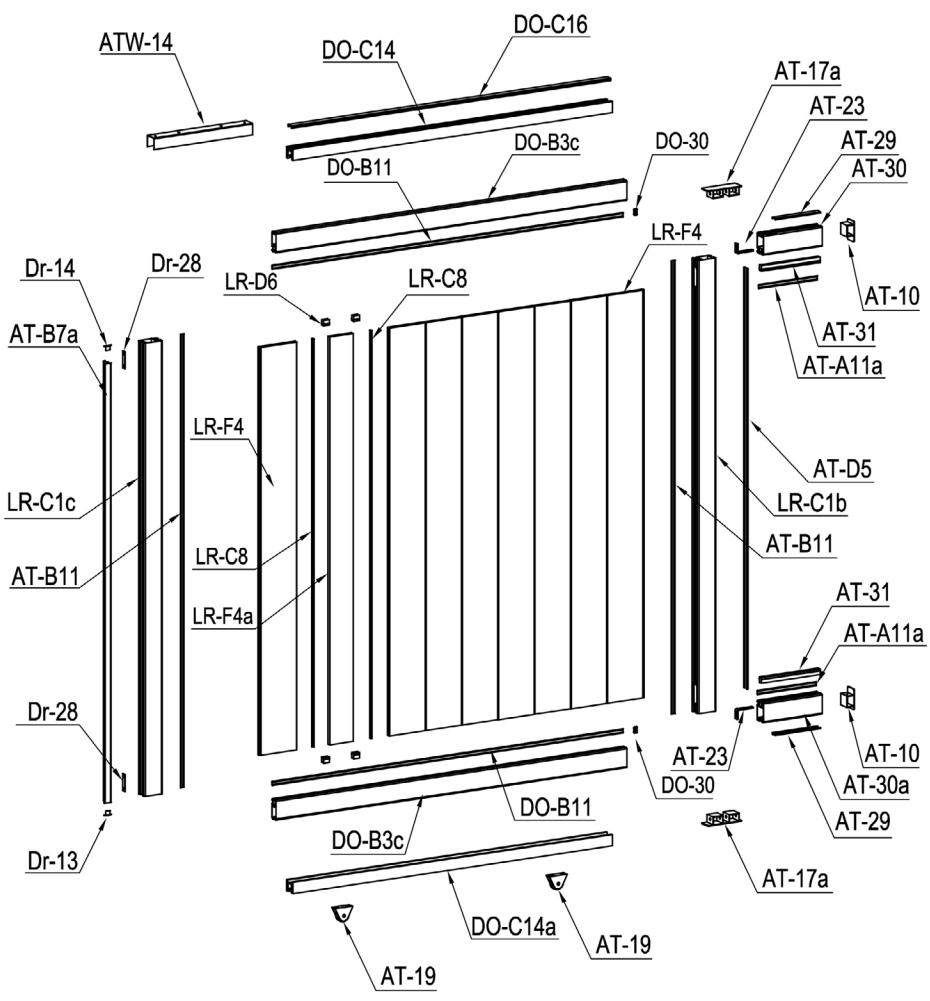

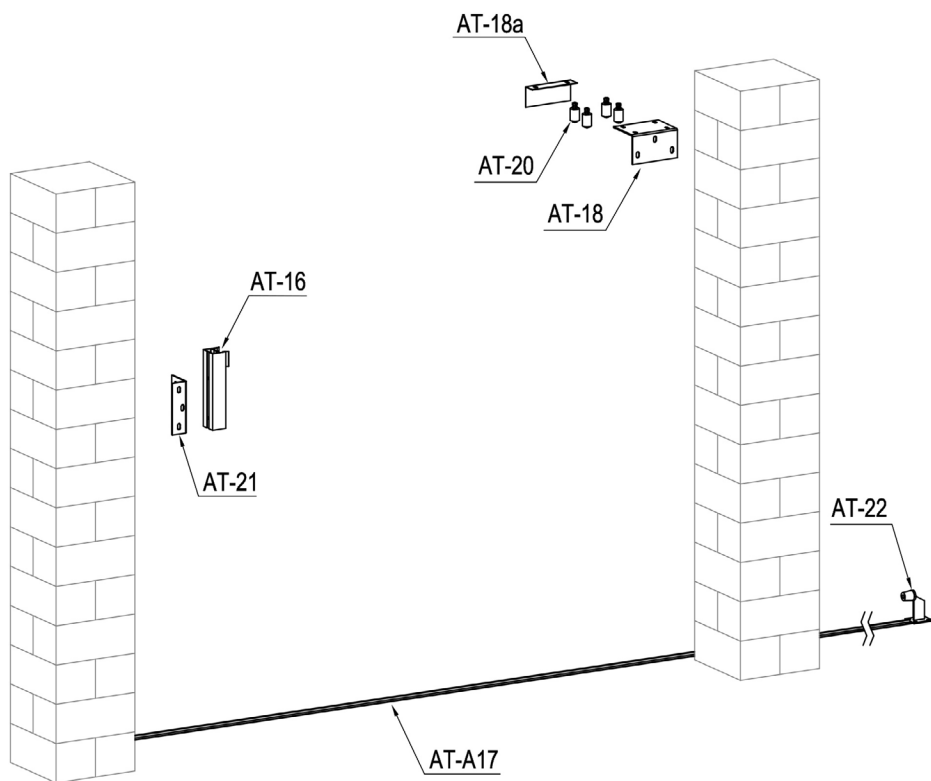

















































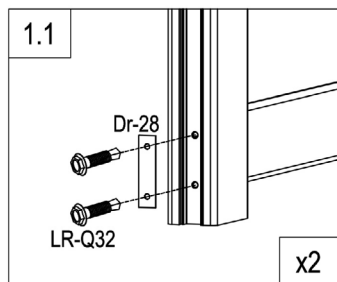
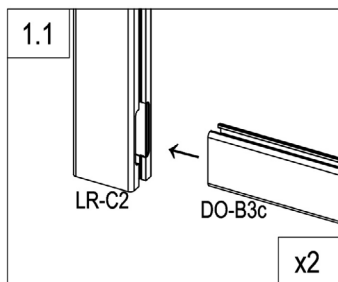
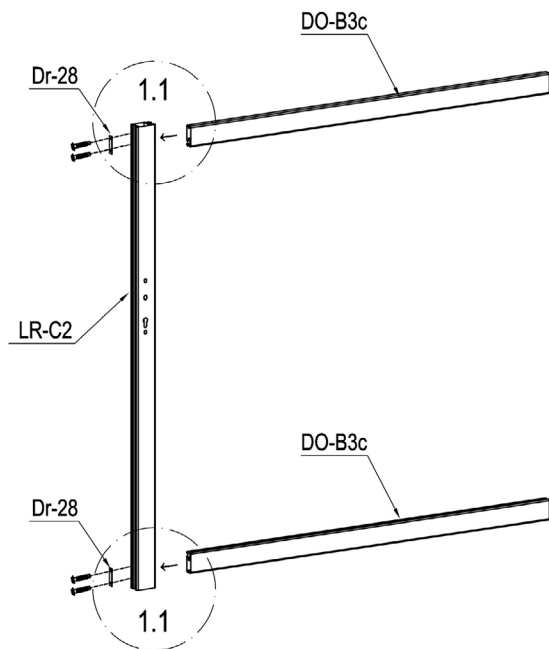

PART LIST

IMAGE	NO.	L.(mm)	QTY	IMAGE	NO.	L.(mm)	QTY
	LR-C1b	1728	2		DO-30		4
	LR-C1c	1728	1		AT-18		1
	LR-C2	1728	1		AT-18a		1
	AT-30	250	1		ATW-14		1
	AT-30a	250	1		AT-19		4
	DO-B3c	1492	4		AT-20		4
	LR-F4	1555	16		AT-21		1
	LR-F4a	1555	2		AT-22		1
	AT-B5b	1728	1		AT-23		2
	AT-D5	1603	1		Dr-18		1
	AT-B5a	550.5	1		Dr-19		1
	Dr-A5b	937	1		Dr-20a		1
	AT-29	193	2		Dr-21		1
	AT-B11	1728	4		Dr-22		1
	AT-A11a	250	2		Dr-25		1
	DO-B11	1492	4		Dr-25a		2
	AT-31	250	2		Dr-27		2
	LR-D6	25	8		Dr-28		6
	LR-C8	1555	4		AT-22J		7
	AT-B7a	1675	1		LR-Q30	ST4x10	4
	DO-C14	1358	2		LR-Q31	M8x60	10
	DO-C14a	1358	2		LR-Q32	ST5.5x38	28
	DO-C16	1357	2		LR-Q33	M8x130	4
	AT-16		1		LR-Q34	ST4.8x38	12
	AT-A17	1212	5		LR-Q35	ST4.2x19	42
	AT-17		2		LR-Q36	M6x20	2
	AT-17a		2		LR-Q37	M8x20	8
	AT-10		4		LR-Q38	ST4x25	40
	Dr-13		1				
	Dr-14		1				



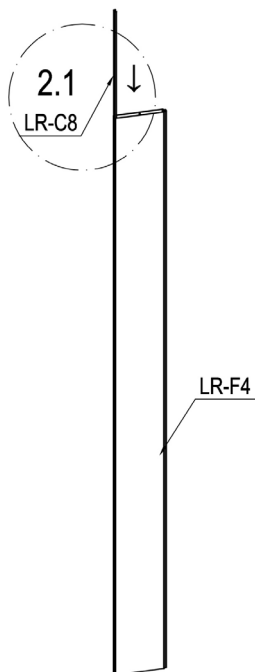

	LR-C2	1
	DO-B3c	2
	Dr-28	2
	LR-Q32	4

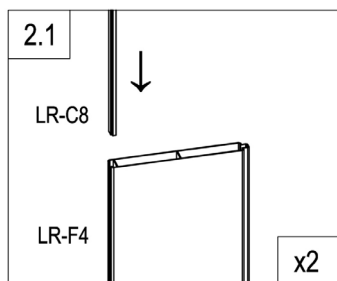

x2



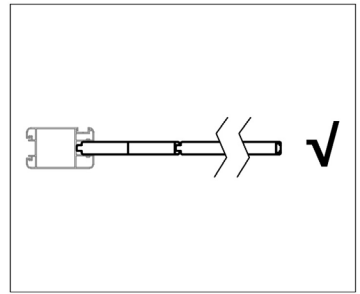
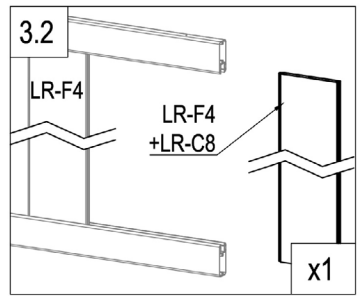
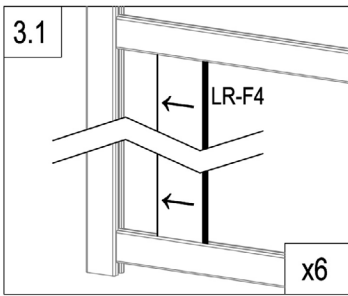
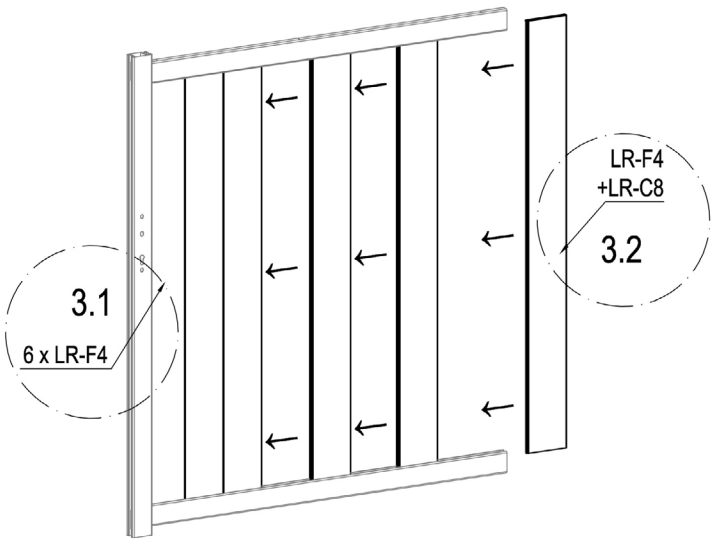

	LR-C8	2
	LR-F4	2



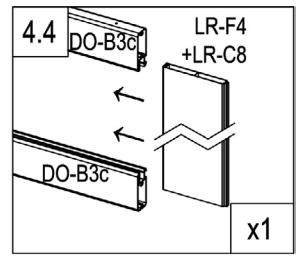
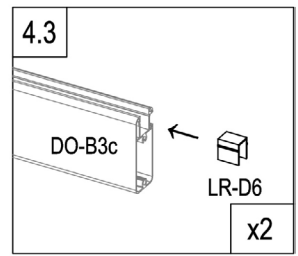
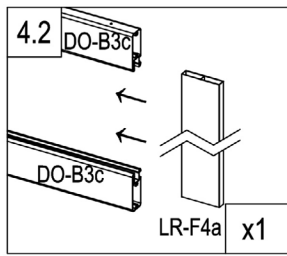
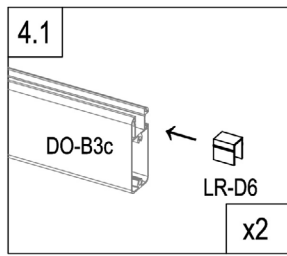
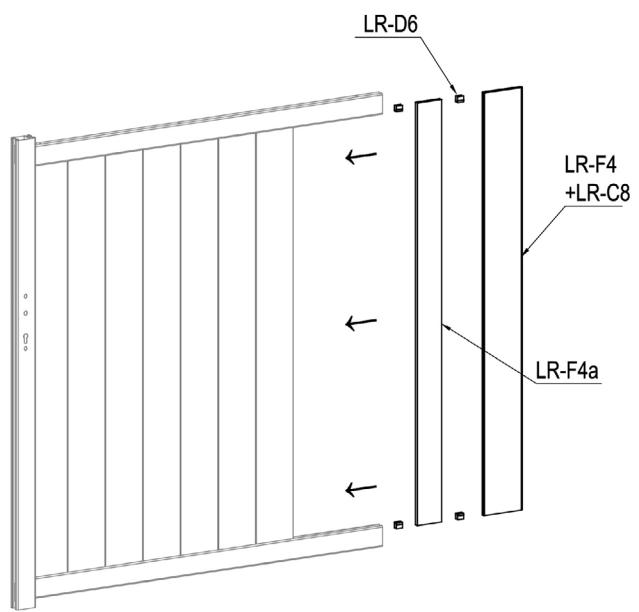

	LR-F4	6
---	-------	---



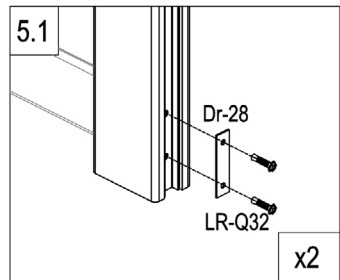
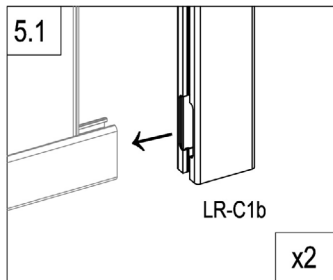
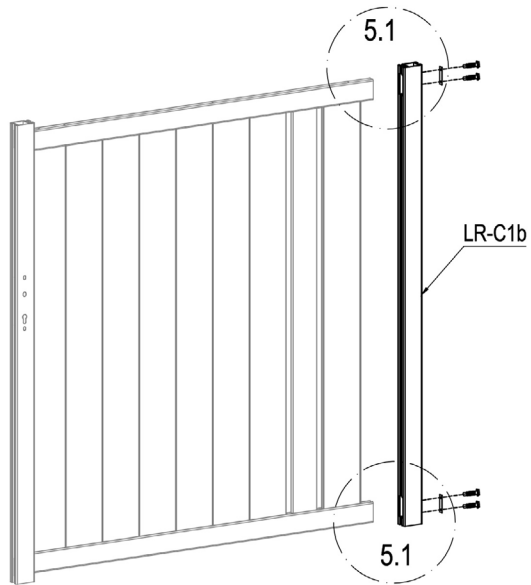

	LR-F4a	1
	LR-D6	4

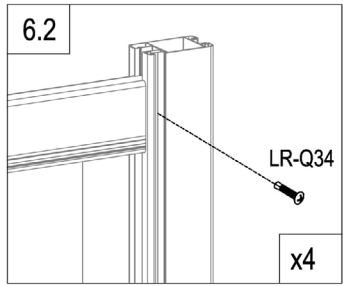
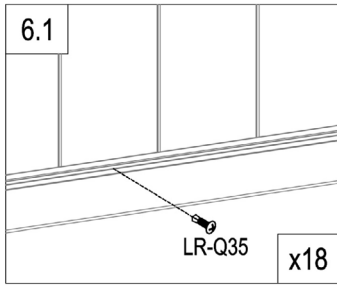
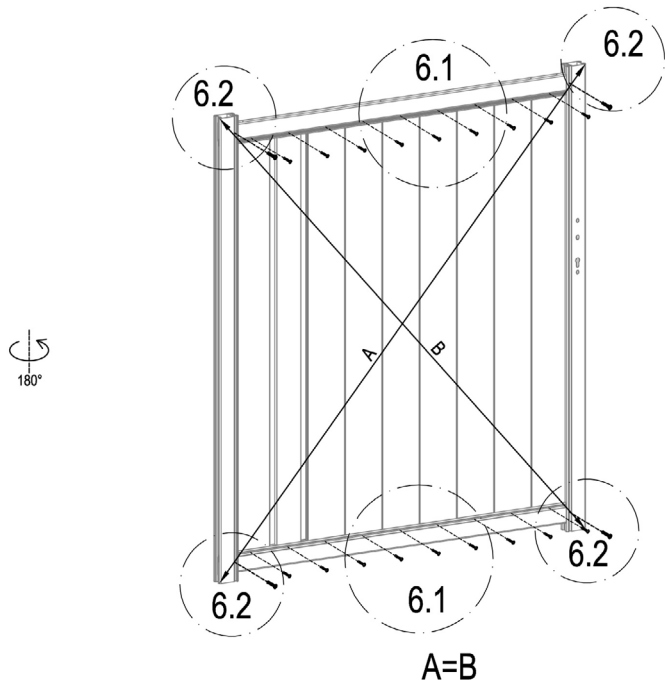

	LR-C1b	1
	Dr-28	2
	LR-Q32	4



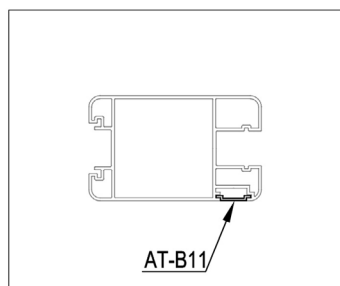
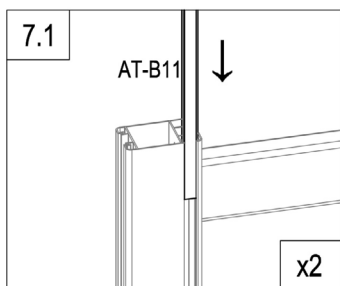
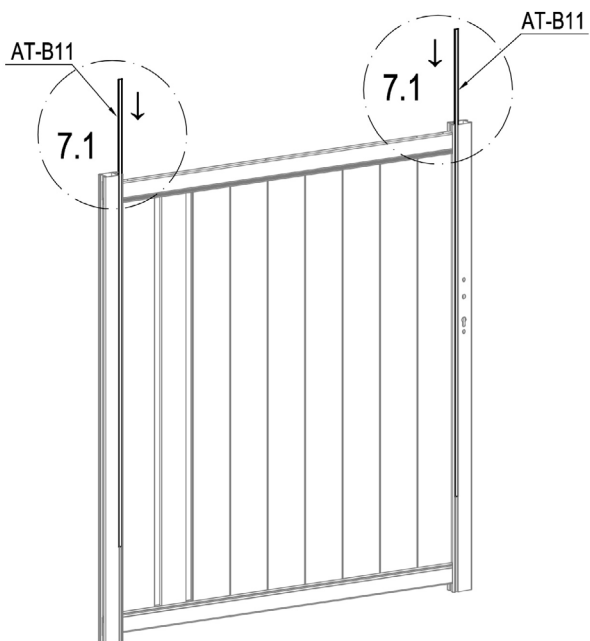

	LR-Q35	18
	LR-Q34	4



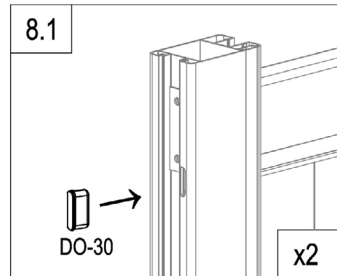
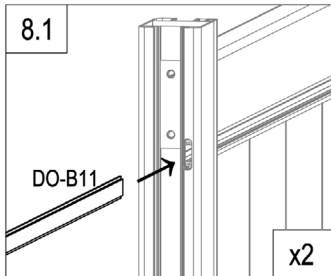
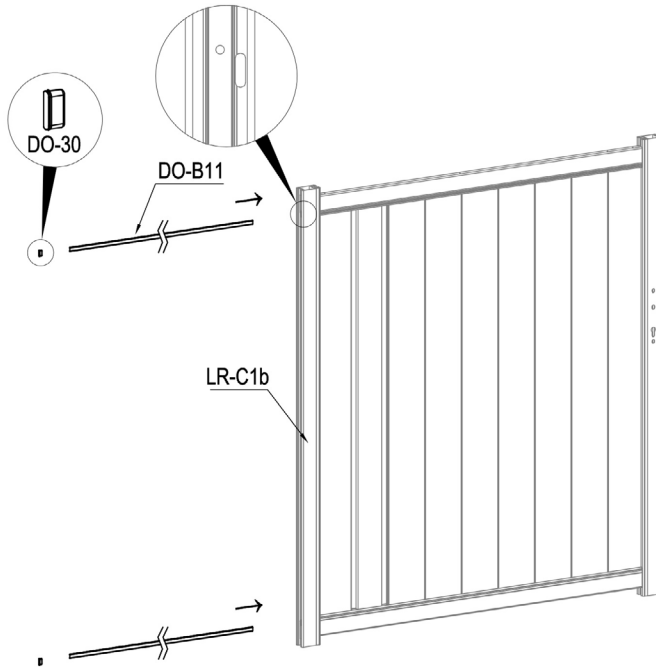

	AT-B11	2
---	--------	---

CASANOVA



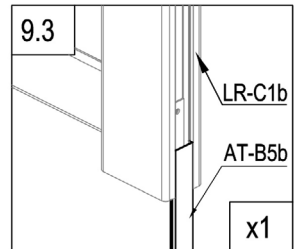
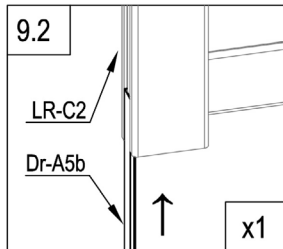
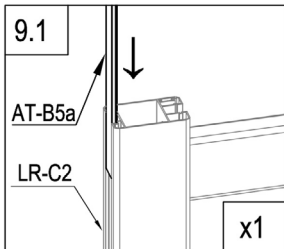
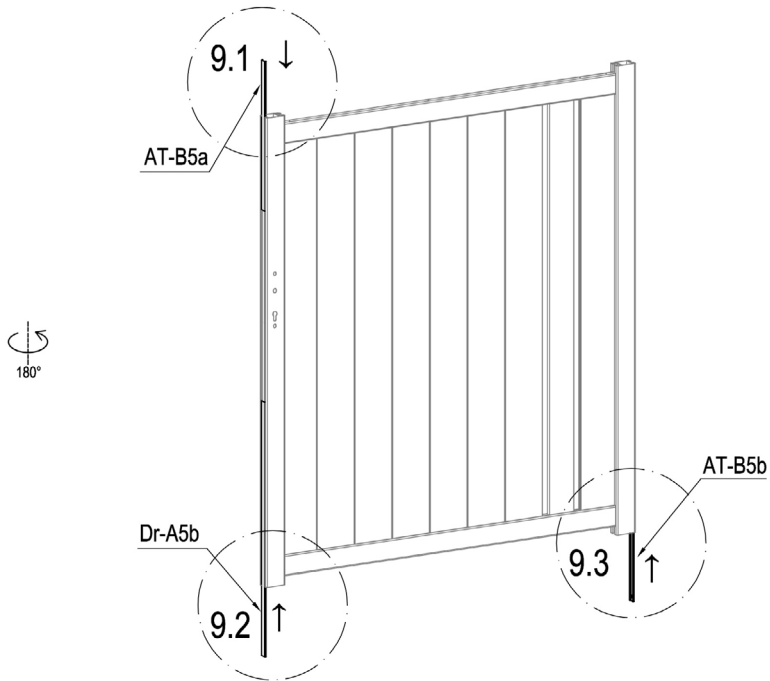

	DO-B11	2
	DO-30	2



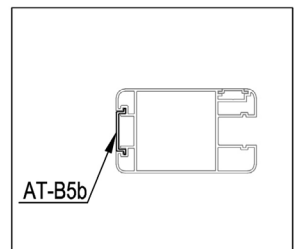

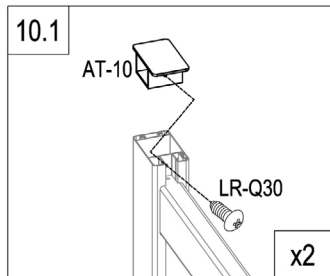
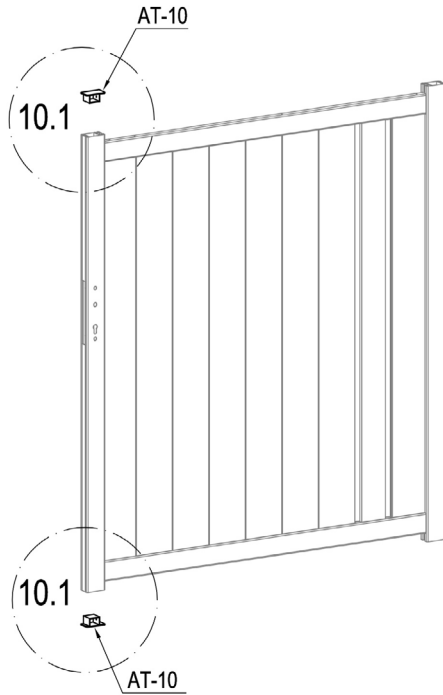

	AT-B5b	1
	AT-B5a	1
	Dr-A5b	1



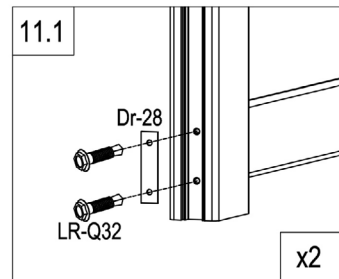
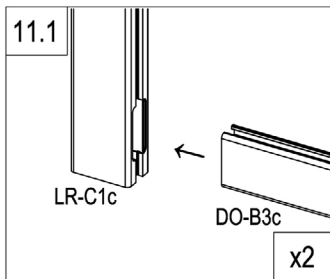
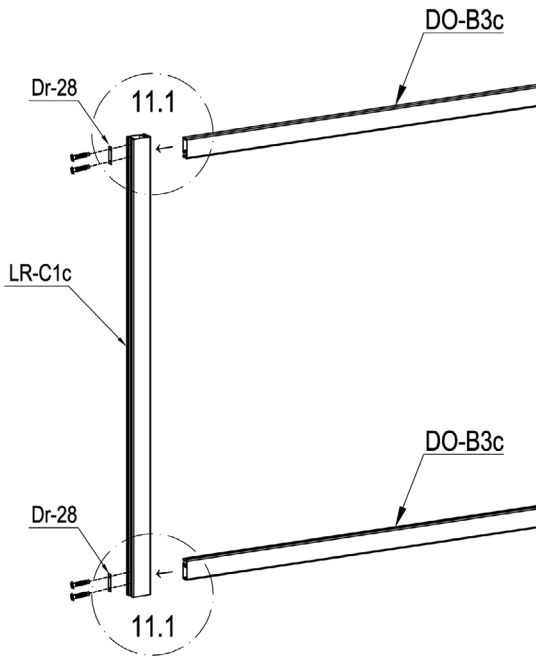



	AT-10	2
	LR-Q30	2



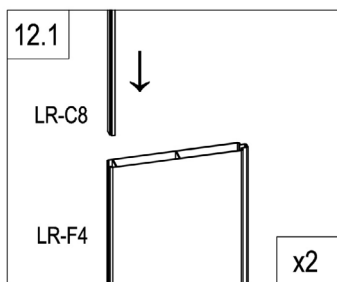
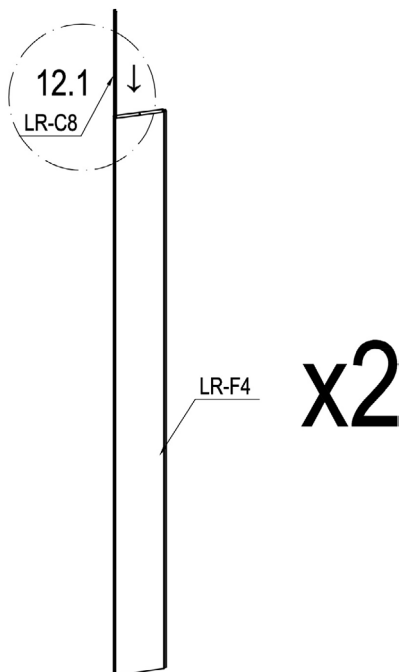

	LR-C1c	1
	DO-B3c	2
	Dr-28	2
	LR-Q32	4

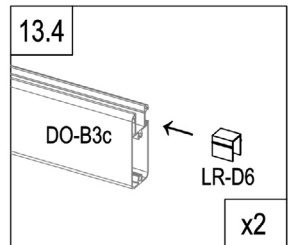
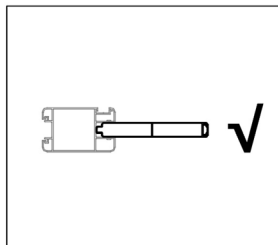
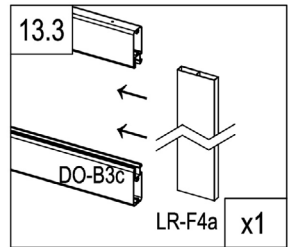
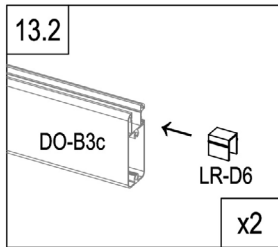
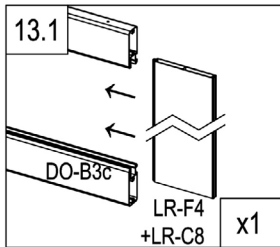
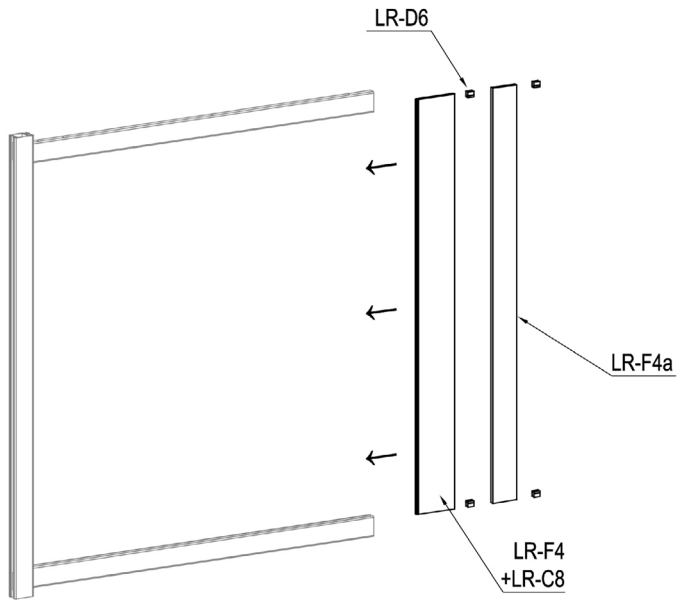

	LR-C8	2
	LR-F4	2



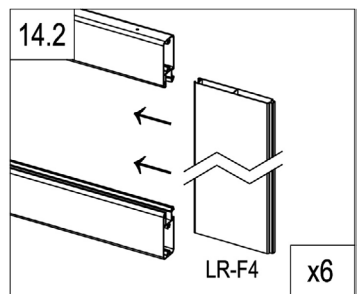
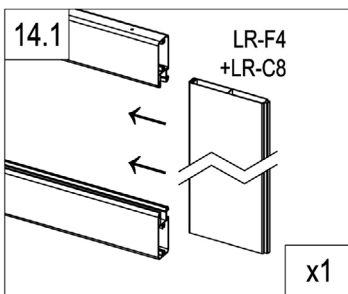
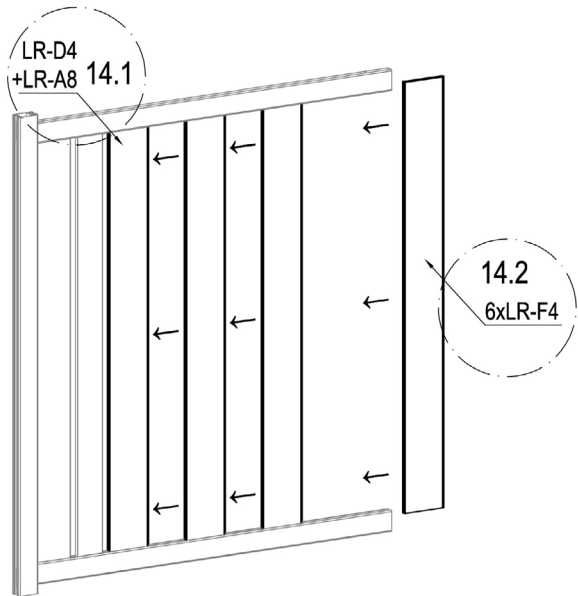

	LR-F4a	1
	LR-D6	4



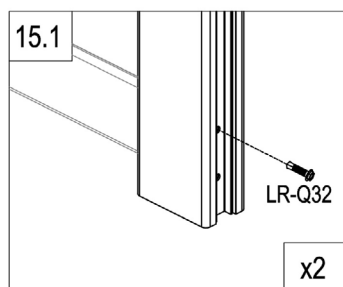
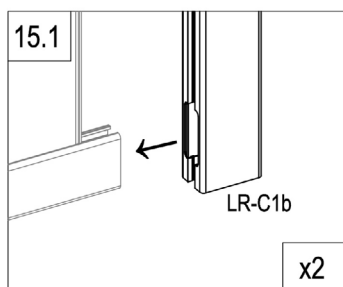
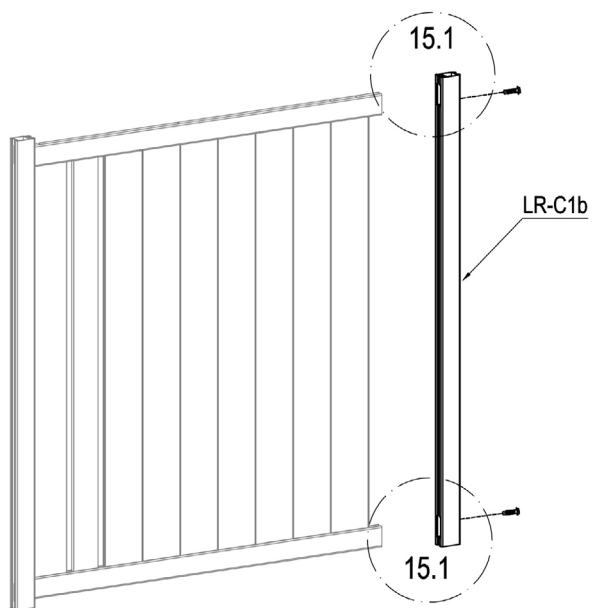

	LR-F4	6
---	-------	---

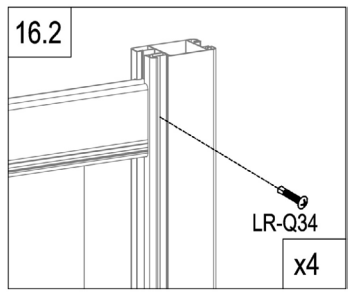
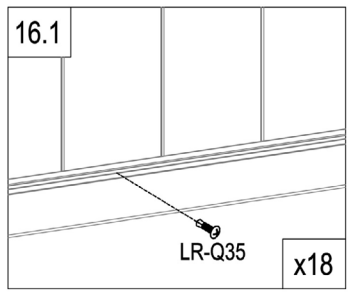
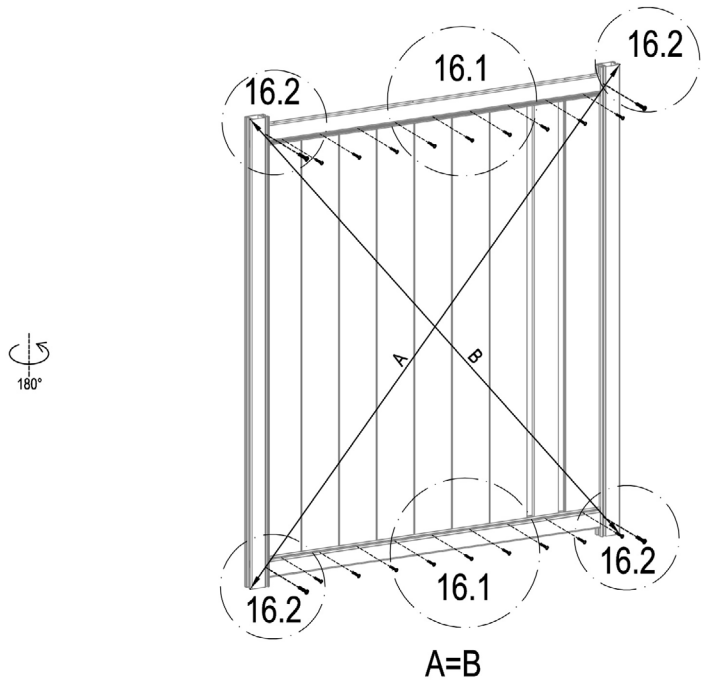

	LR-C1b	1
	LR-Q32	2



	LR-Q35	18
	LR-Q34	4

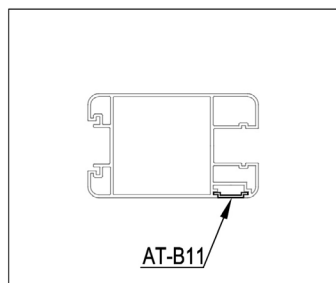
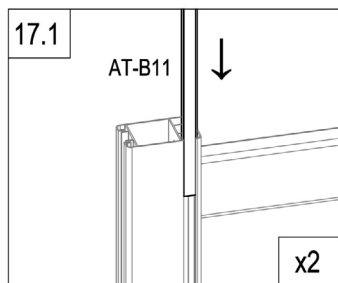
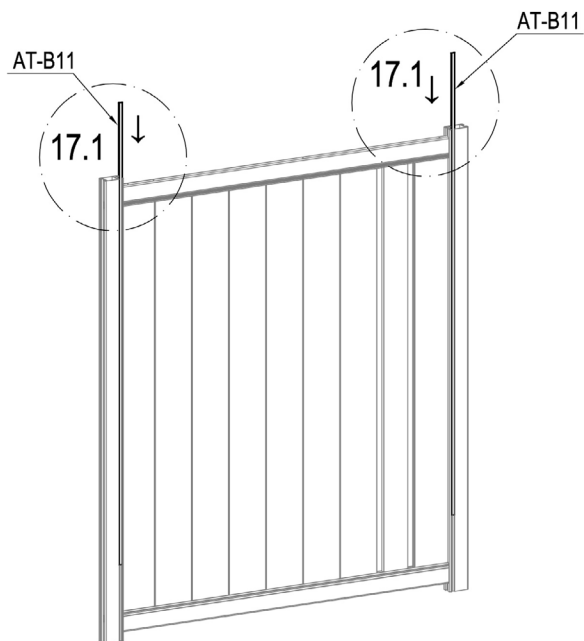



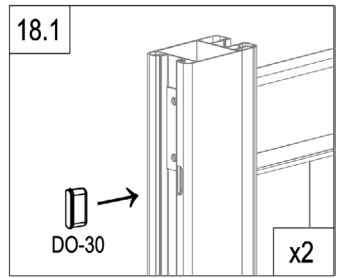
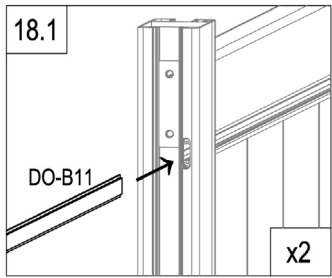
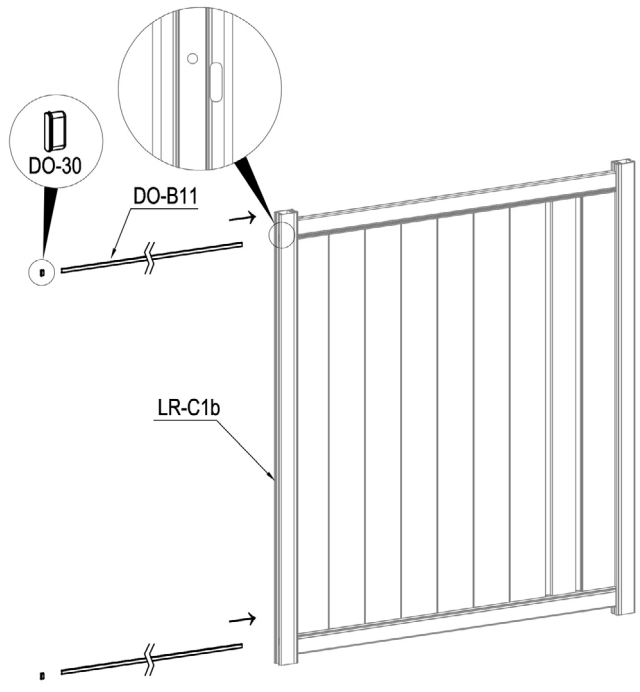

	AT-B11	2
---	--------	---

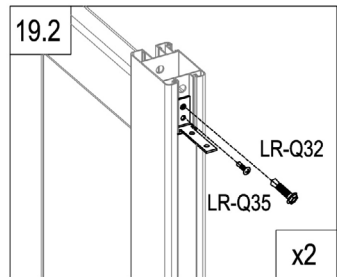
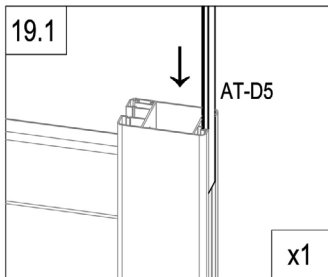
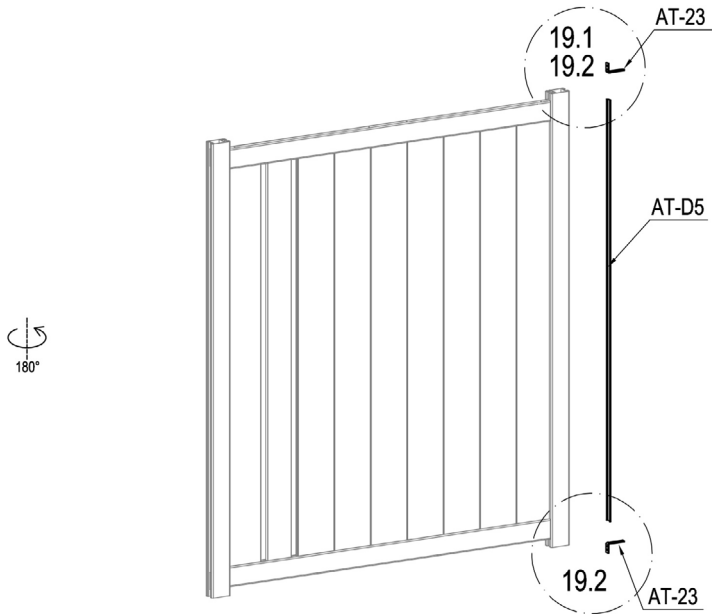

	DO-B11	2
	DO-30	2





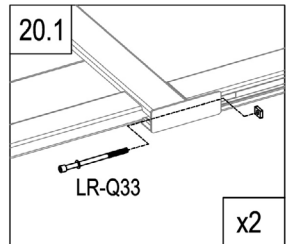
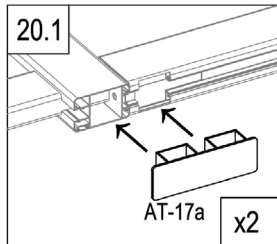
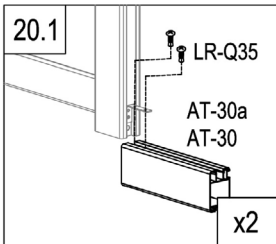
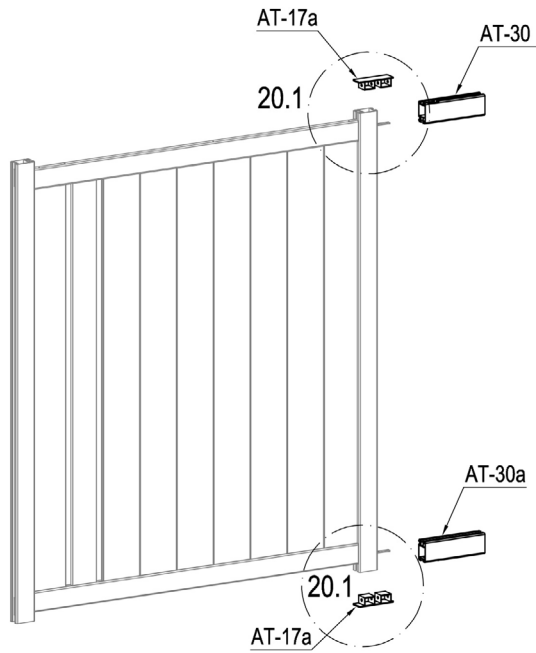

	AT-D5	1
	AT-23	2
	LR-Q32	2
	LR-Q35	2



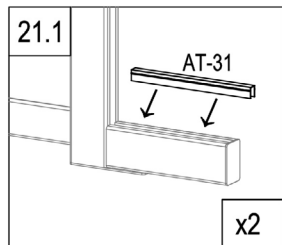
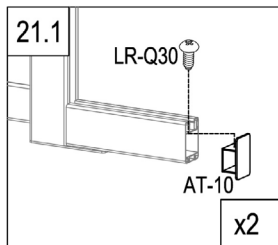
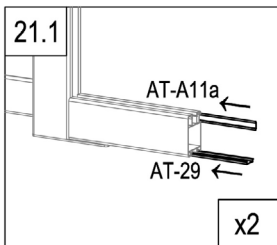
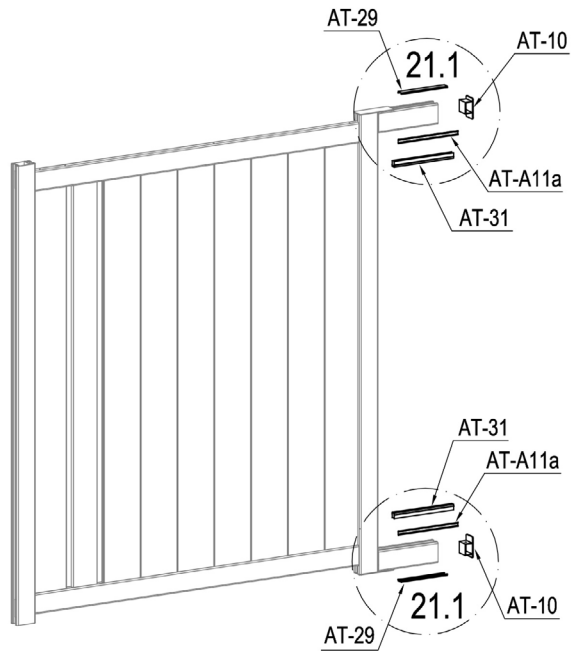

	AT-30	1
	AT-30a	1
	AT-17a	2



	LR-Q33	2
	LR-Q35	4



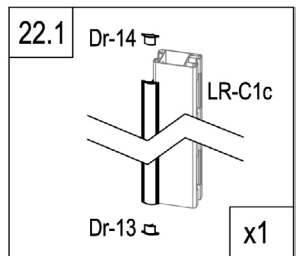
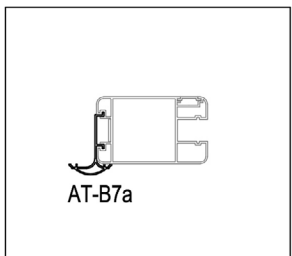
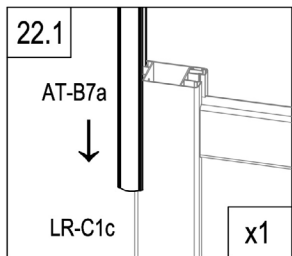
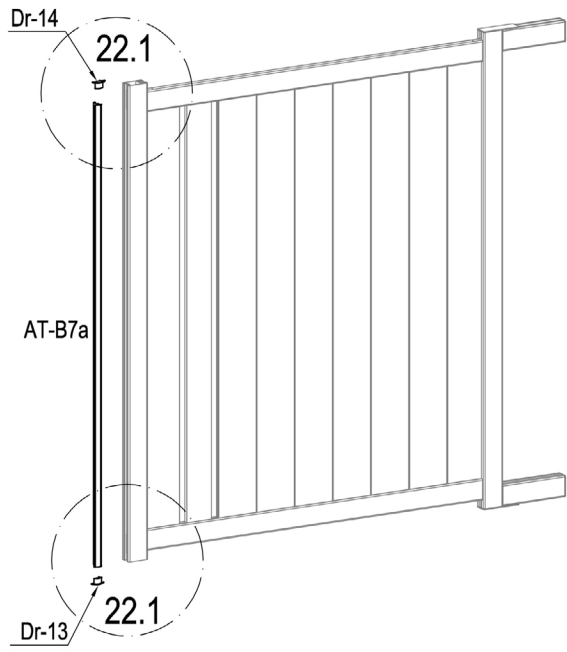

	AT-29	2
	AT-A11a	2
	AT-31	2

	AT-10	2
	LR-Q30	2

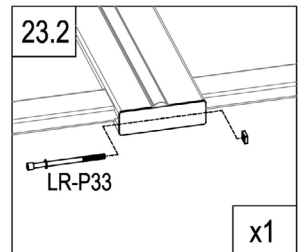
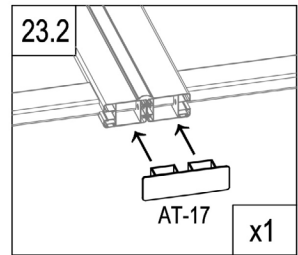
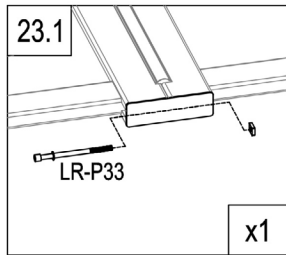
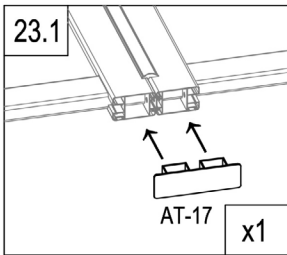
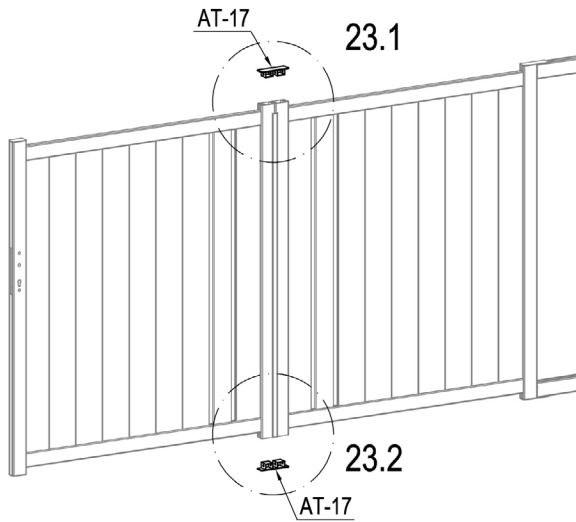

	AT-B7a	1
	Dr-13	1
	Dr-14	1



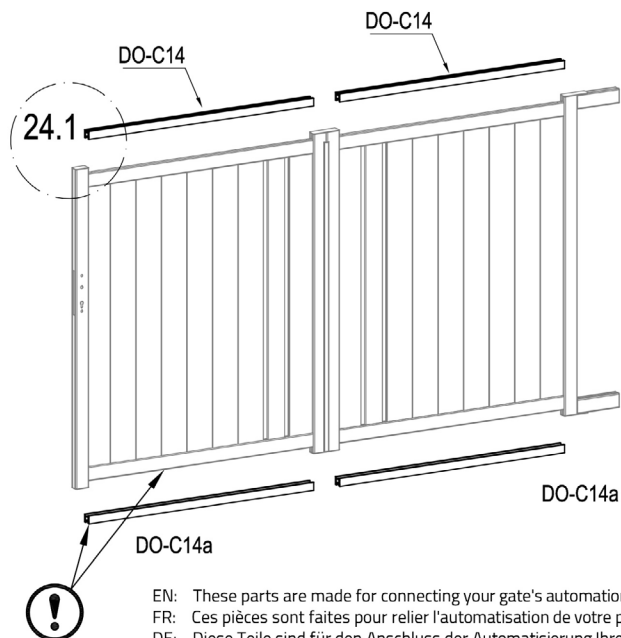

	AT-17	2
	LR-Q33	2



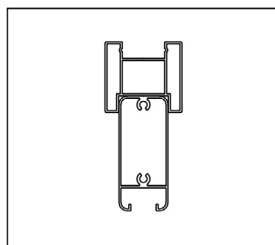
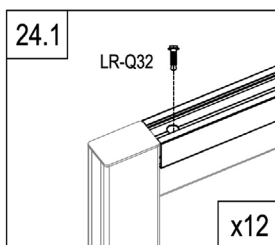
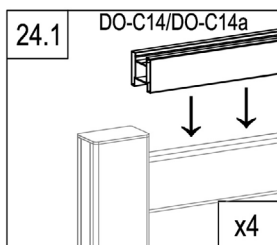

EN: These parts are made for connecting your gate's automation
 FR: Ces pièces sont faites pour relier l'automatisation de votre portail
 DE: Diese Teile sind für den Anschluss der Automatisierung Ihres Tores vorgesehen
 ES: Estas piezas están hechas para conectar la automatización de su puerta
 PT: Estas peças são feitas para ligar a automatização do seu portão
 IT: Queste parti sono realizzate per collegare l'automazione del vostro cancello
 NL: Deze onderdelen zijn gemaakt voor het aansluiten van de automatisering van uw poort.
 PL: Te części są wykonane do podłączenia automatyki bramy.



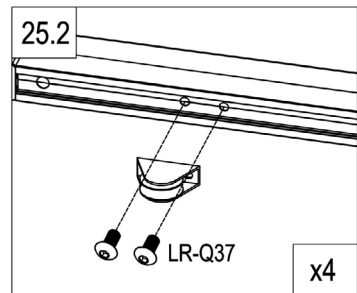
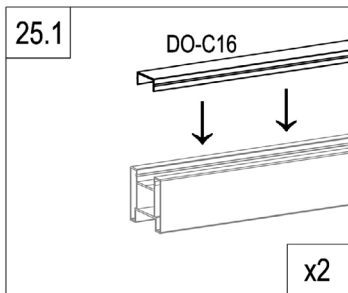
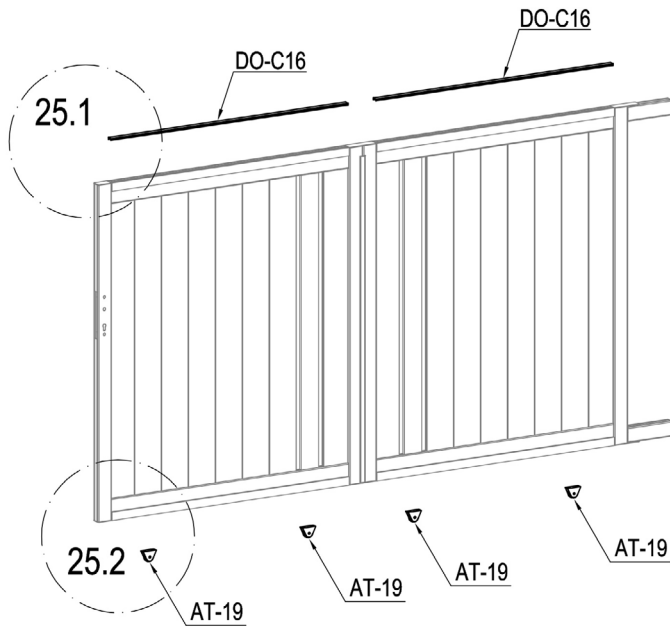

	DO-C14	2
	DO-C14a	2
	LR-Q32	12

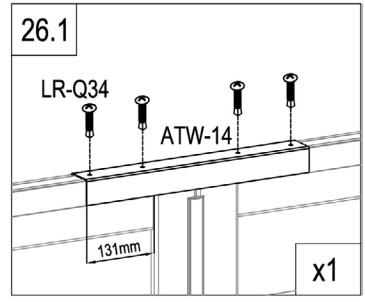
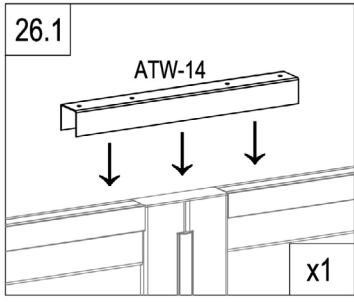
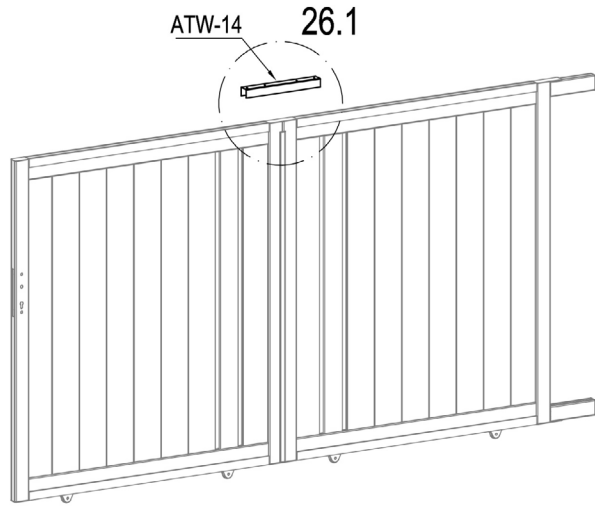

	DO-C16	2
	AT-19	4
	LR-Q37	8



	ATW-14	1
	LR-Q34	4

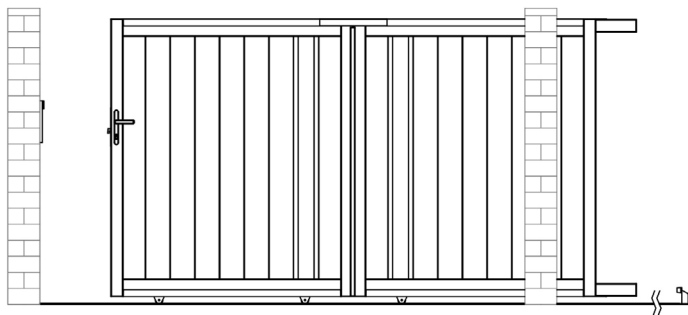

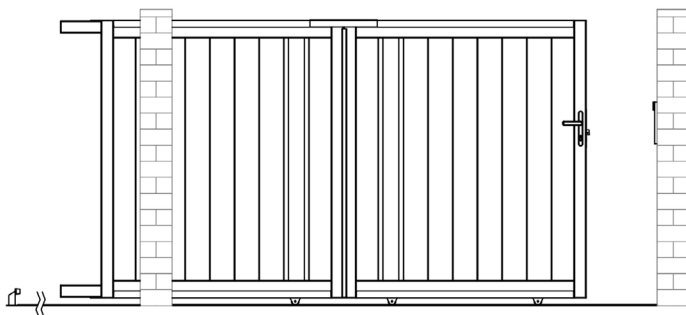

L

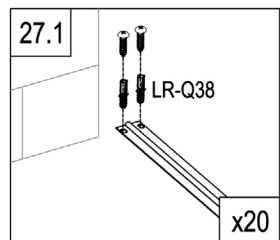
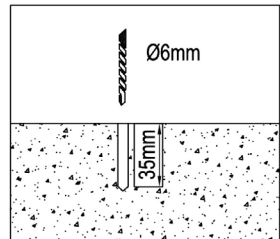
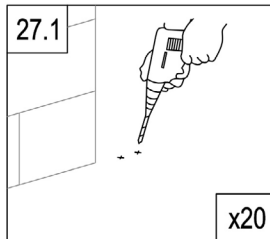
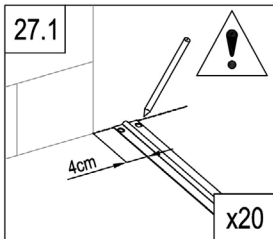
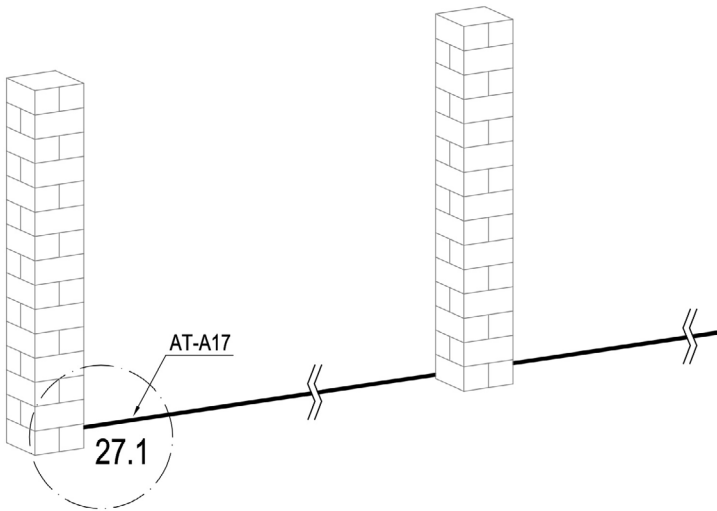

R

L



	AT-A17	5
	LR-Q38	40

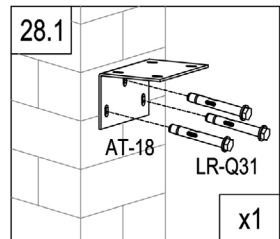
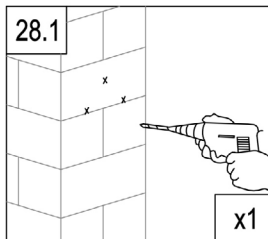
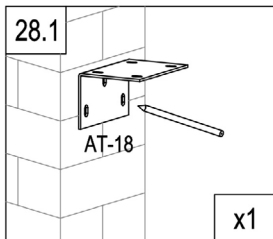
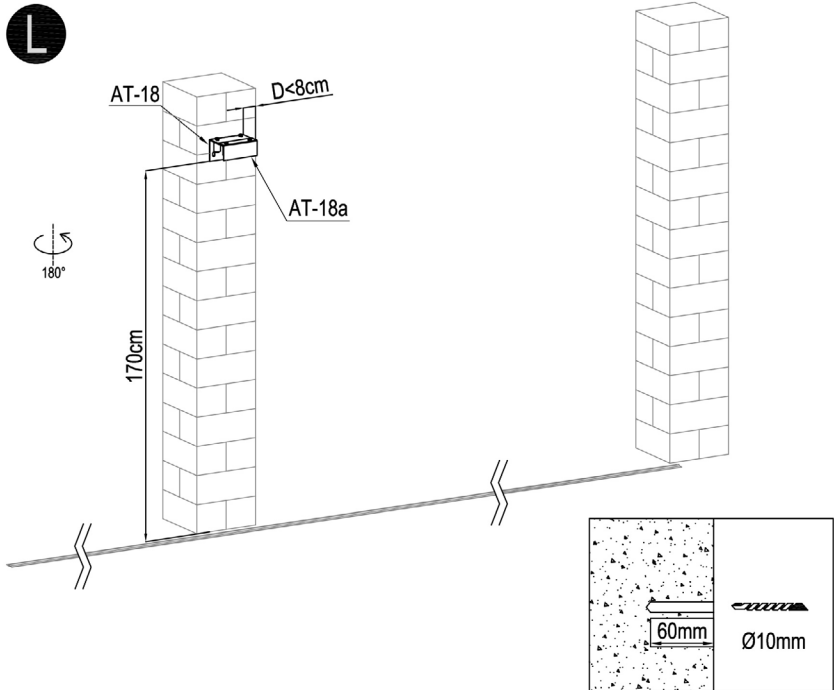

	AT-18	1
	AT-18a	1
	AT-20	4
	LR-Q31	3

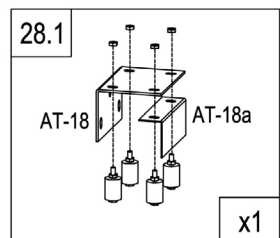
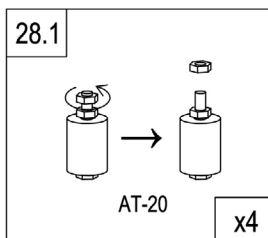

L

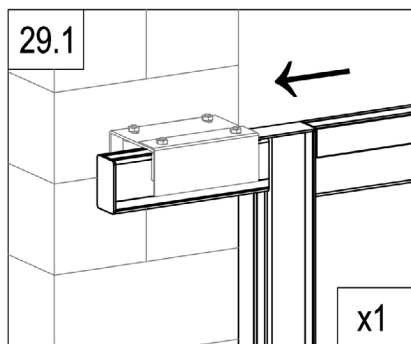
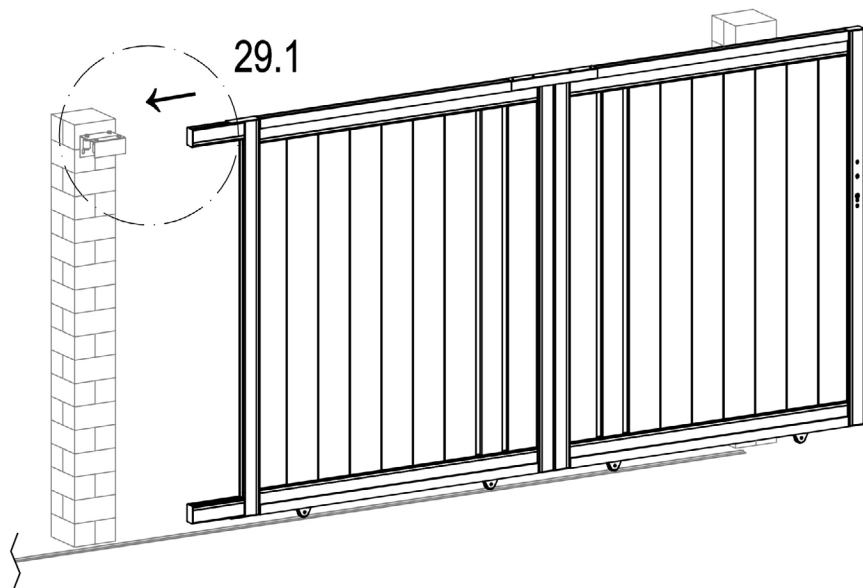

L

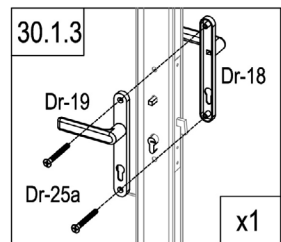
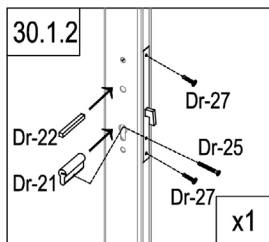
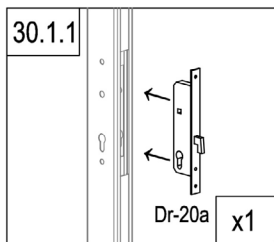
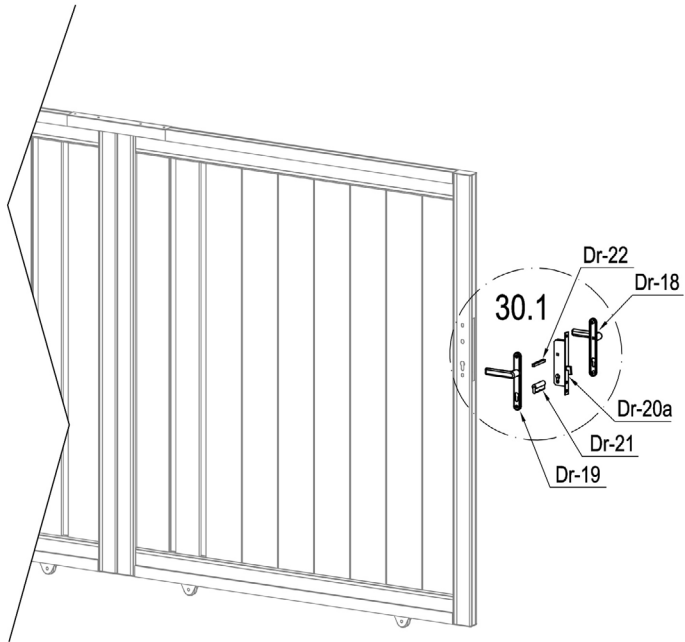

	Dr-20a	1
	Dr-21	1
	Dr-22	1
	Dr-25	1

	Dr-18	1
	Dr-19	1
	Dr-25a	2
	Dr-27	2

L

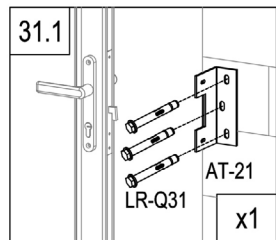
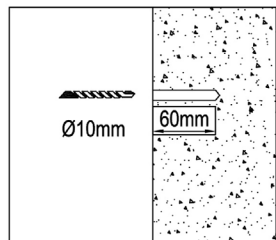
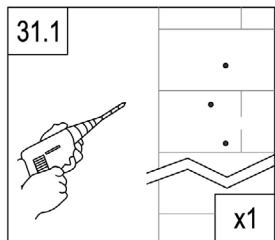
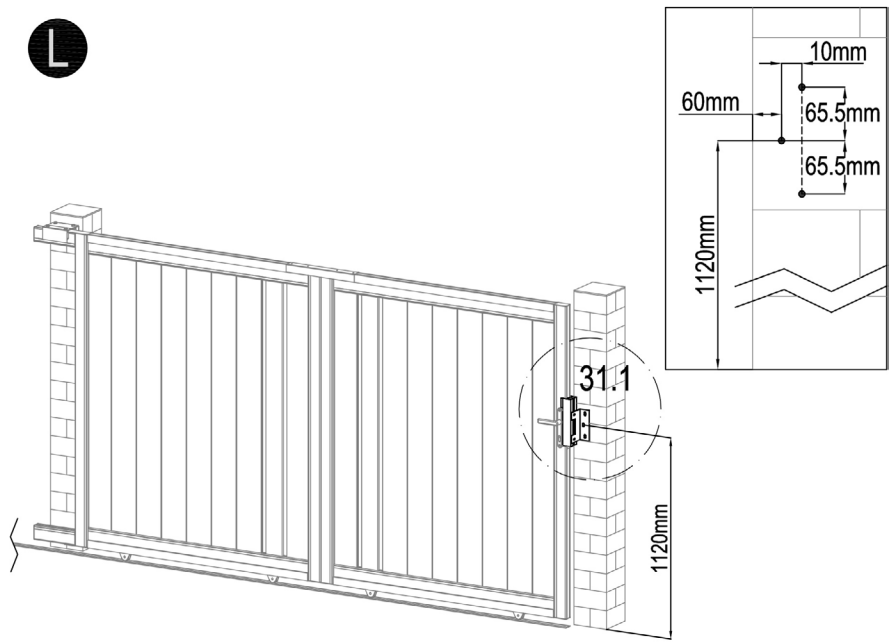

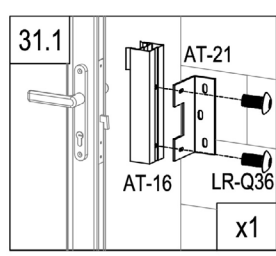
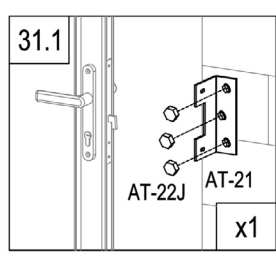

	AT-16	1
	AT-21	1
	LR-Q36	2
	LR-Q31	3
	AT-22J	3

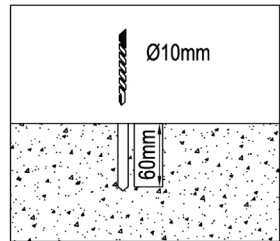
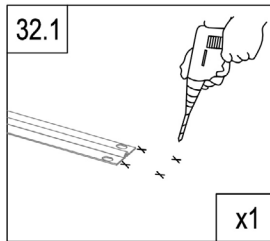
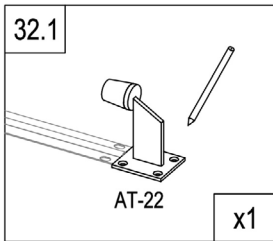
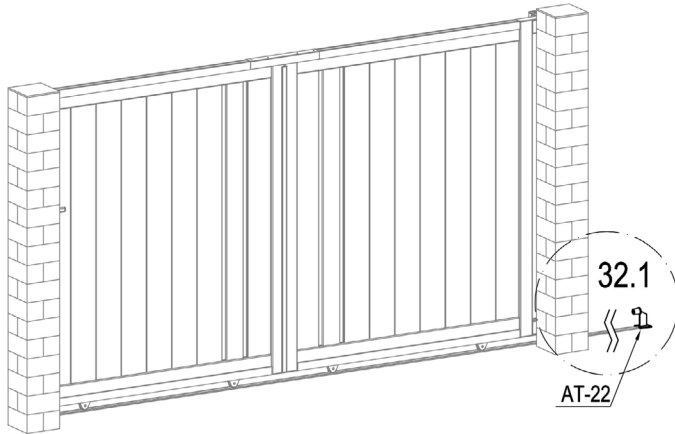

L



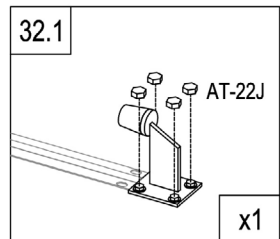
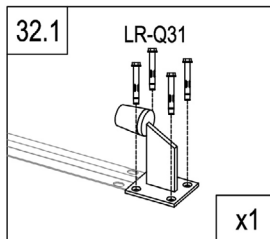

	AT-22	1
	LR-Q31	4
	AT-22J	4

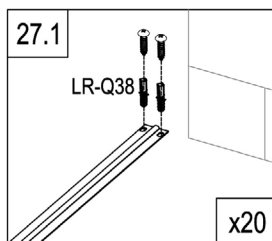
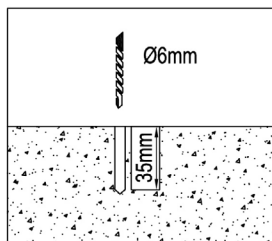
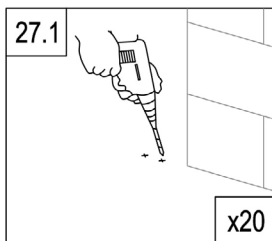
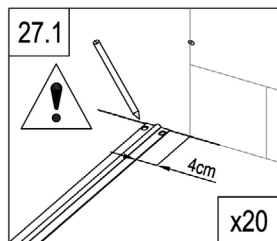
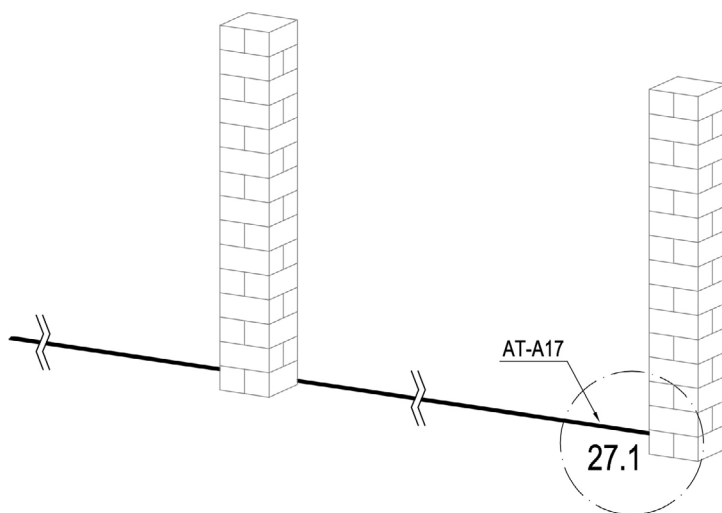

R



	AT-A17	5
	LR-Q38	40

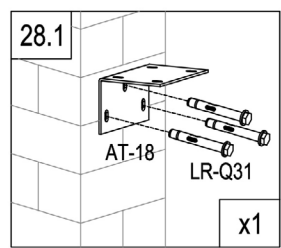
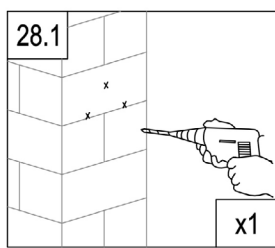
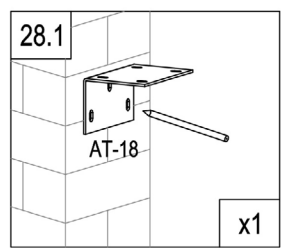
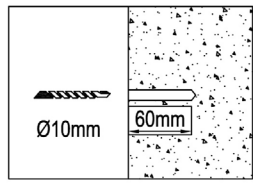
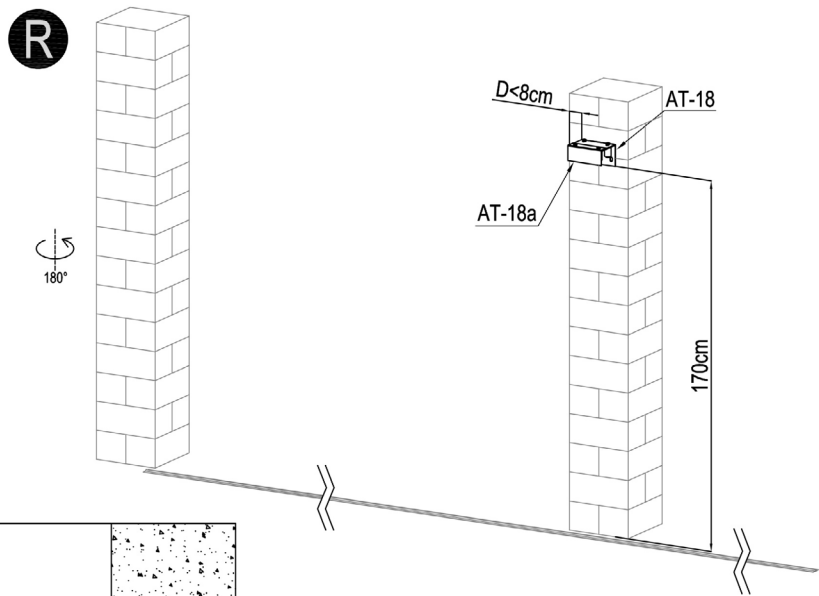

	AT-18	1
	AT-18a	1
	AT-20	4
	LR-Q31	3

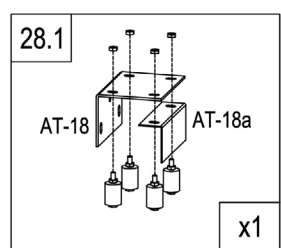
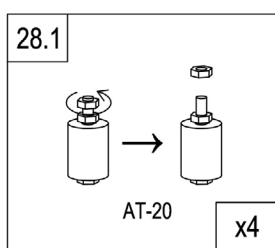

R

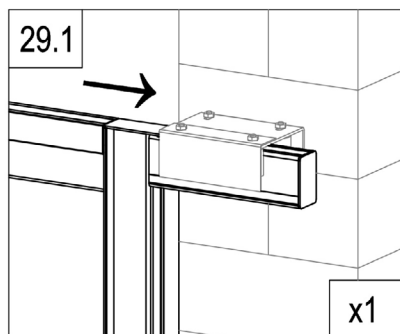
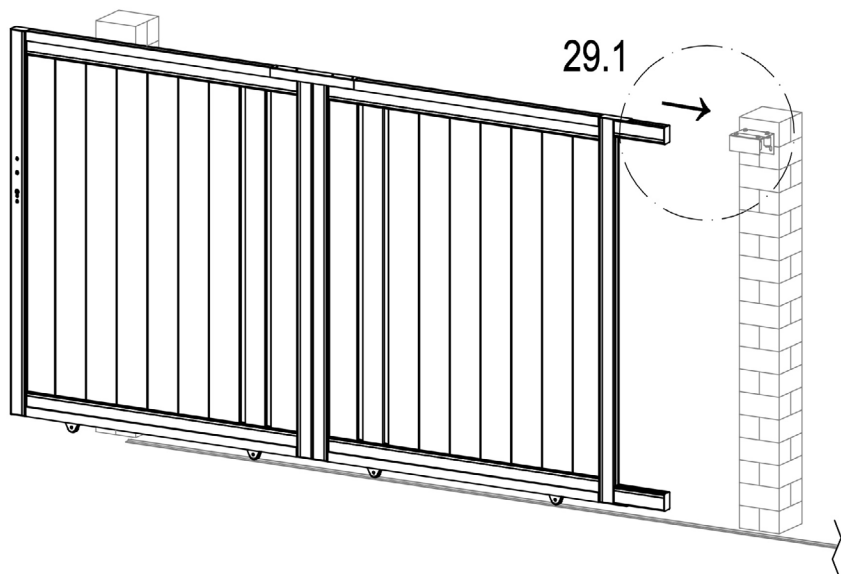

R

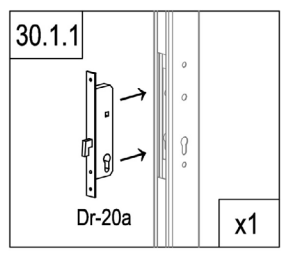
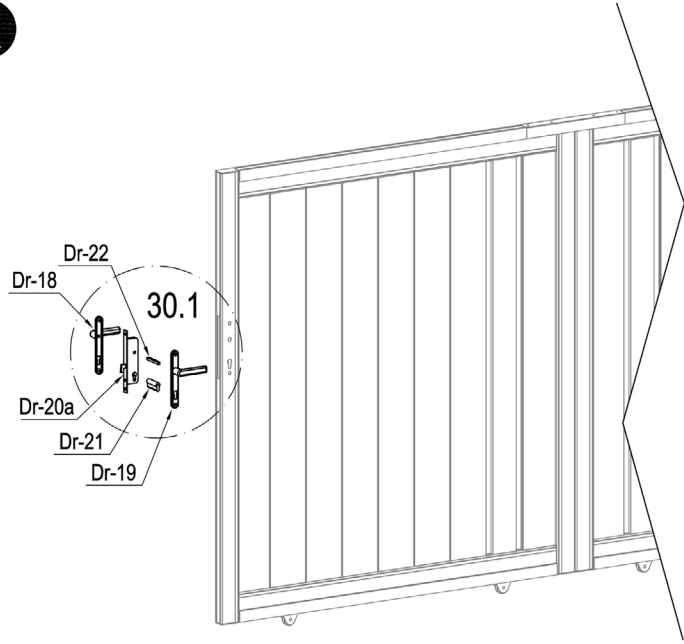

	Dr-20a	1
	Dr-21	1
	Dr-22	1
	Dr-25	1

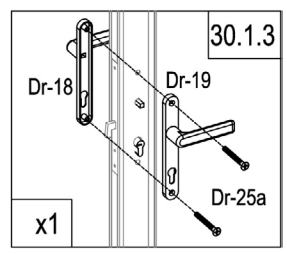
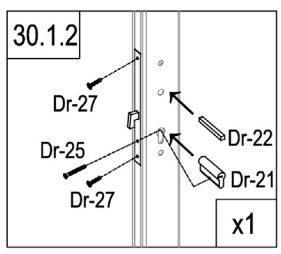

	Dr-18	1
	Dr-19	1
	Dr-25a	2
	Dr-27	2

R

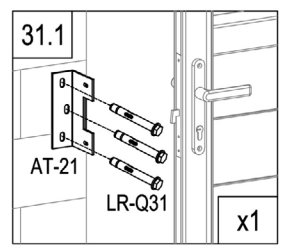
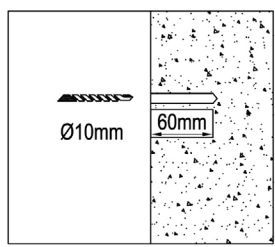
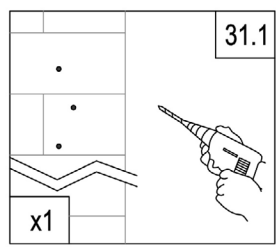
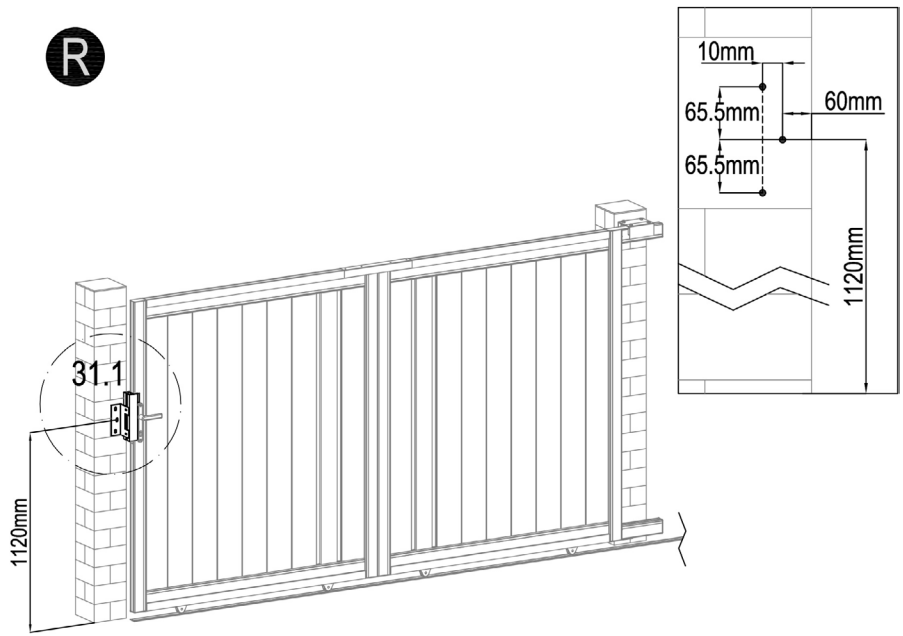

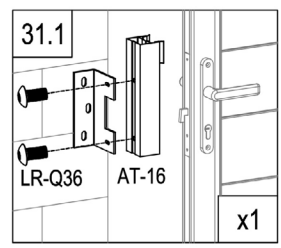
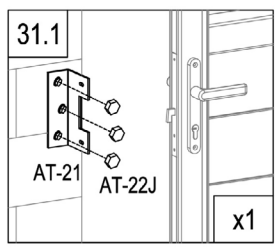

	AT-16	1
	AT-21	1
	LR-Q36	2
	LR-Q31	3
	AT-22J	3

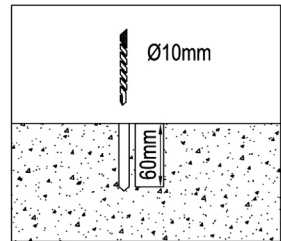
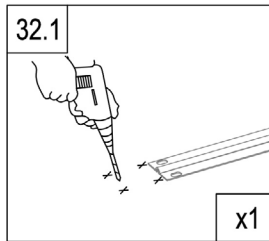
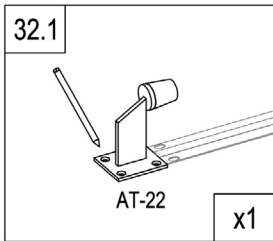
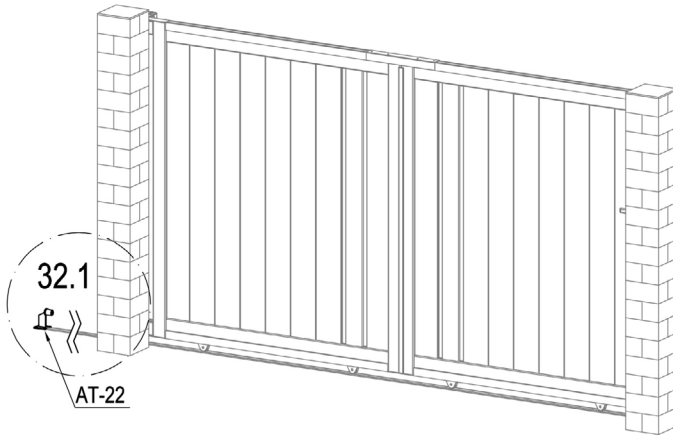

R



	AT-22	1
	LR-Q31	4
	AT-22J	4

