

CASANOVO

EIGER 600C140

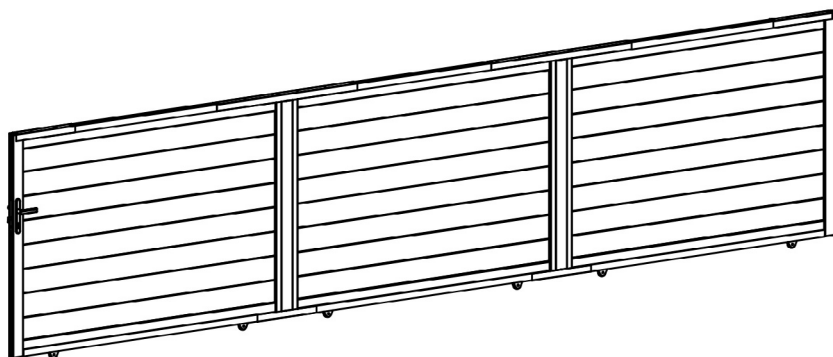

COM-001112 [x1]

COM-001114 [x1]

COM-001214 [x1]

COM-001113 [x1]

COM-001115 [x1]



INSTRUCTION MANUAL / NOTICE DE MONTAGE / MONTAGEANLEITUNG / MANUAL DE MONTAJE / MANUAL DE MONTAGEM / MANUALE DI MONTAGGIO /
MONTAGEHANDLEIDING / INSTRUKCJA MONTAŻU / KÄYTTÖOHJEET / BRUKSANVISNING / BRUGSANVISNING / INSTRUCIUNI DE ASAMBLARE /
NAVODILA ZA SESTAVLJANJE / NÁVOD NA MONTÁŽ / ÖSSZESZERELÉSI ÚTMUTATÓ / NÁVOD K MONTÁŽI / UPUTE ZA INSTALACIJU /
ΟΔΗΓΙΕΣ ΣΥΝΑΡΜΟΛΟΓΗΣΗΣ / SURINKIMO INSTRUKCIJOS / MONTĀŽAS INSTRUKCIJAS

Ext.

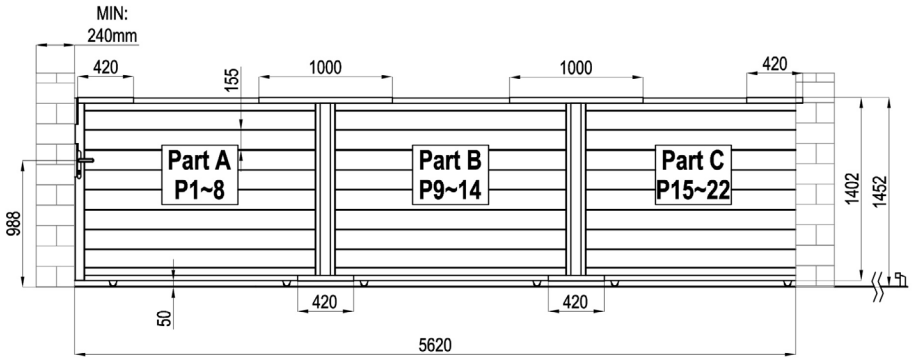

Int.

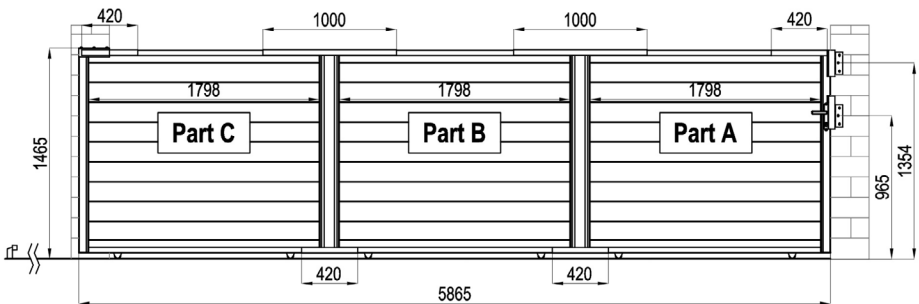

Part A.

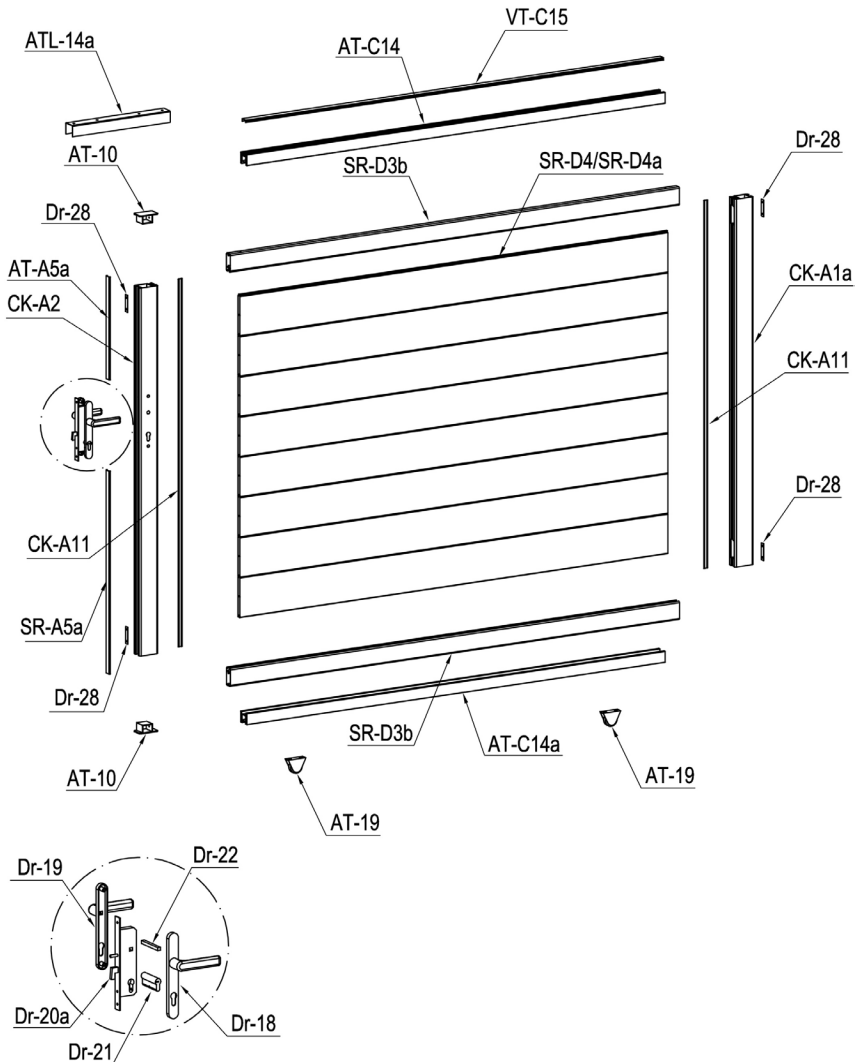

Part B.

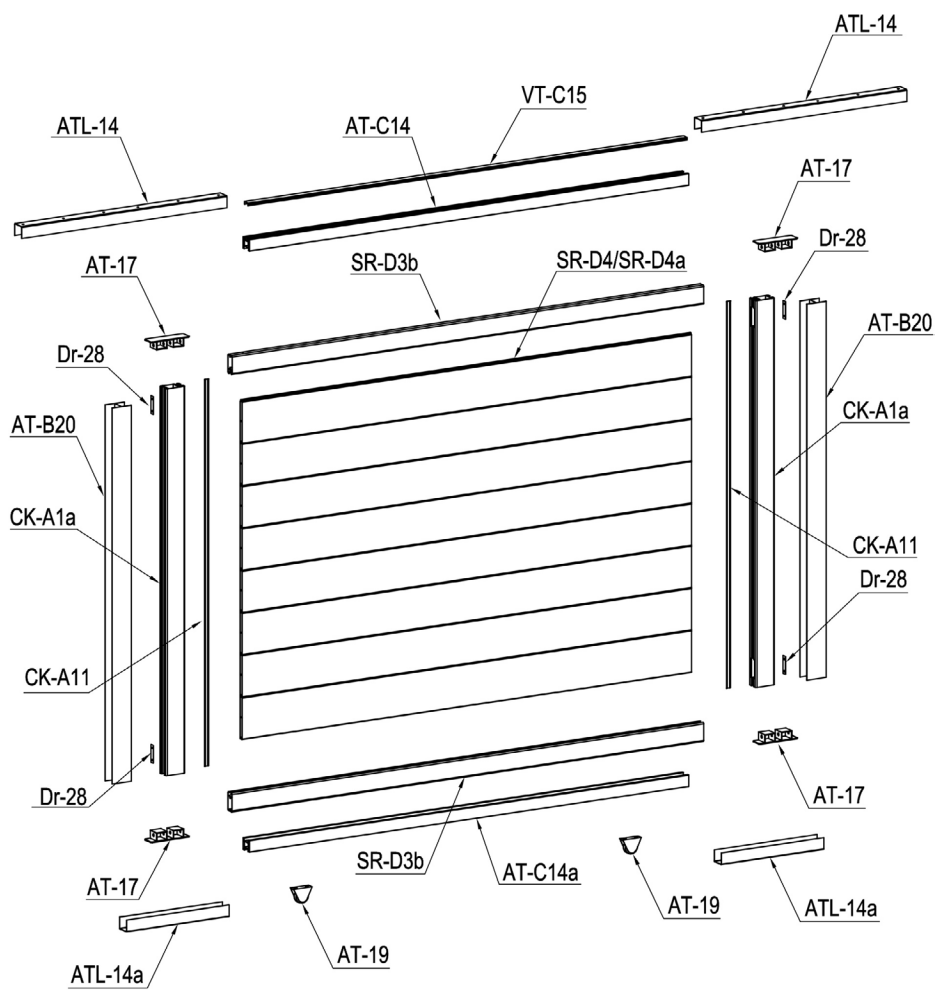



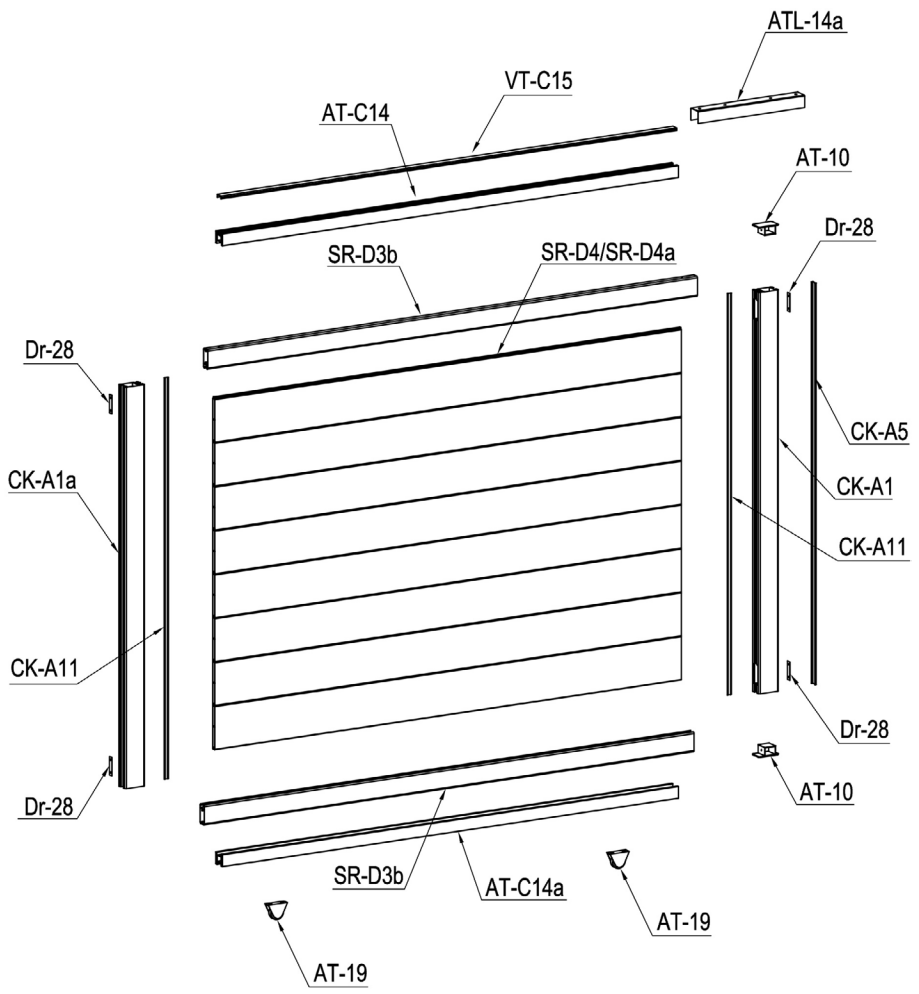

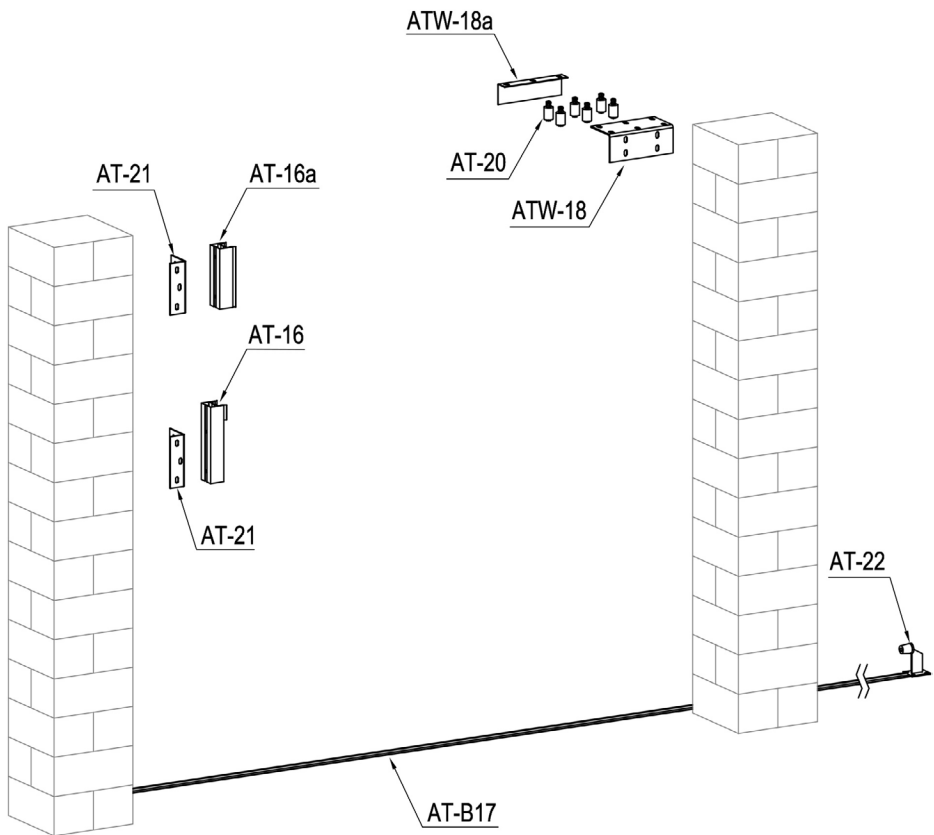

































Part C.







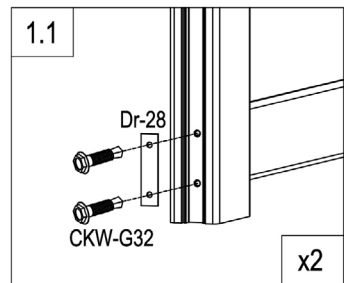
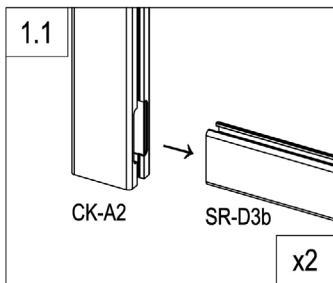
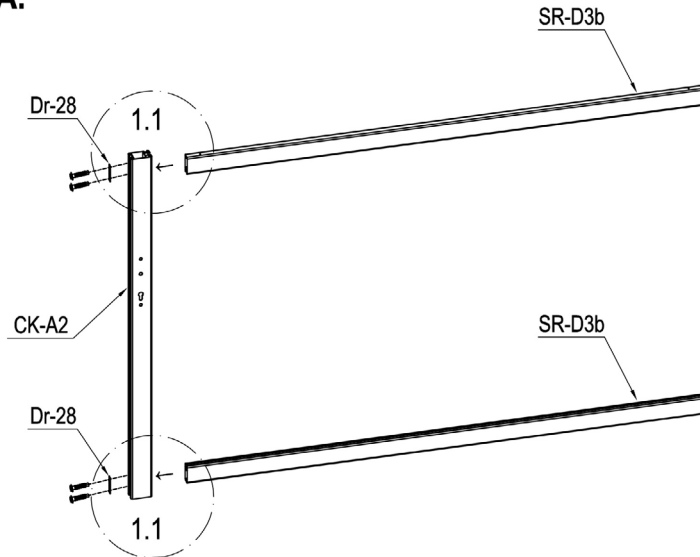

PART LIST

IMAGE	NO.	L.(mm)	QTY	IMAGE	NO.	L.(mm)	QTY
	CK-A1a	1418	4		AT-22		1
	CK-A1	1418	1		Dr-18		1
	CK-A2	1418	1		Dr-19		1
	SR-D3b	1931	6		Dr-20a		1
	SR-D4	1840	21		Dr-21		1
	SR-D4a	1840	3		Dr-22		1
	CK-A5	1418	1		Dr-25		1
	AT-A5a	395.5	1		Dr-25a		2
	SR-A5a	782	1		Dr-27		2
	CK-A11	1418	6		Dr-28		12
	AT-B20	1338	2		ATW-22J		10
	AT-C14	1798	3		CKW-G30	ST4x10	4
	AT-C14a	1798	3		CKW-G31	M8x60	14
	VT-C15	1797	3		CKW-G32	ST5.5x38	48
	AT-16	260	1		CKW-G33	M8x130	4
	AT-16a	205	1		CKW-G34	ST4.8x38	126
	AT-B17	1412	8		CKW-G36	M6x20	4
	ATL-14	1000	2		CKW-G37	M8x20	12
	ATL-14a	420	4		CKW-G38	ST4x25	80
	AT-17		4				
	AT-10		4				
	ATW-18		1				
	ATW-18a		1				
	AT-19		6				
	AT-20		6				
	AT-21		2				

Part A.



	CK-A2	1
	SR-D3b	2
	Dr-28	2
	CKW-G32	4

Part A.

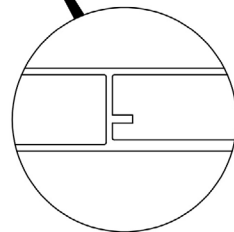
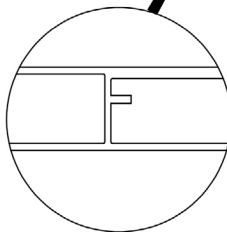
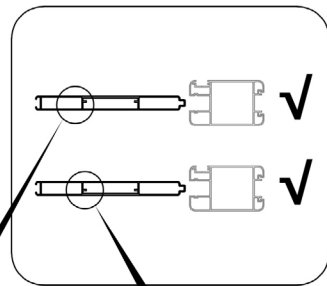
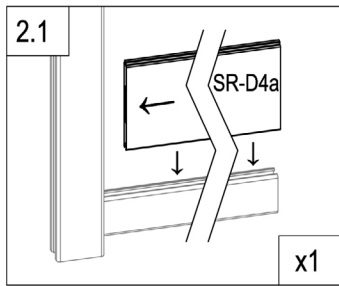
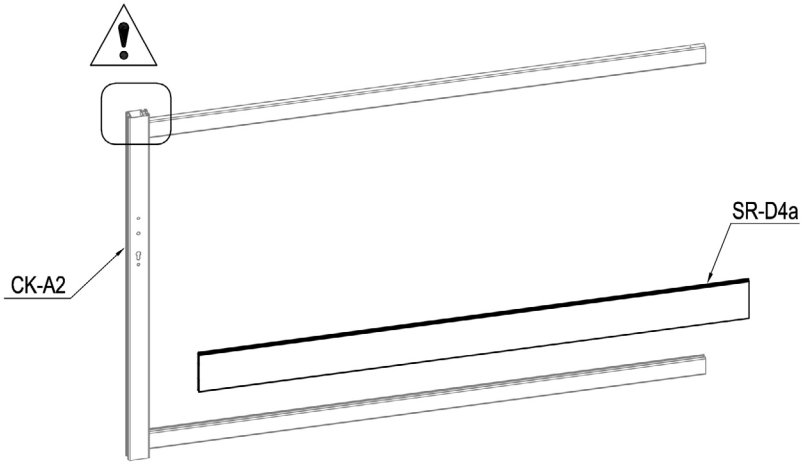

	SR-D4a	1
--	--------	---

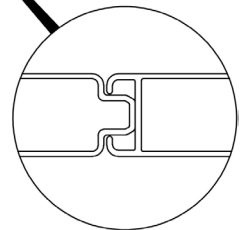
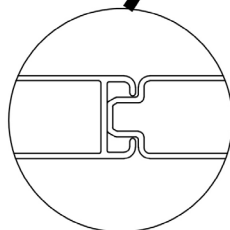
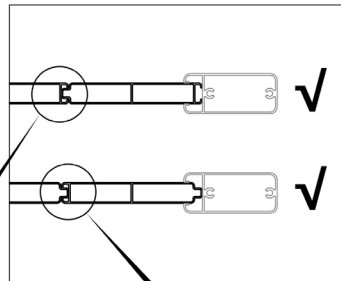
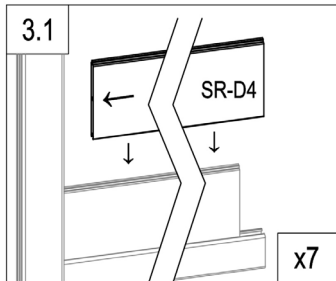
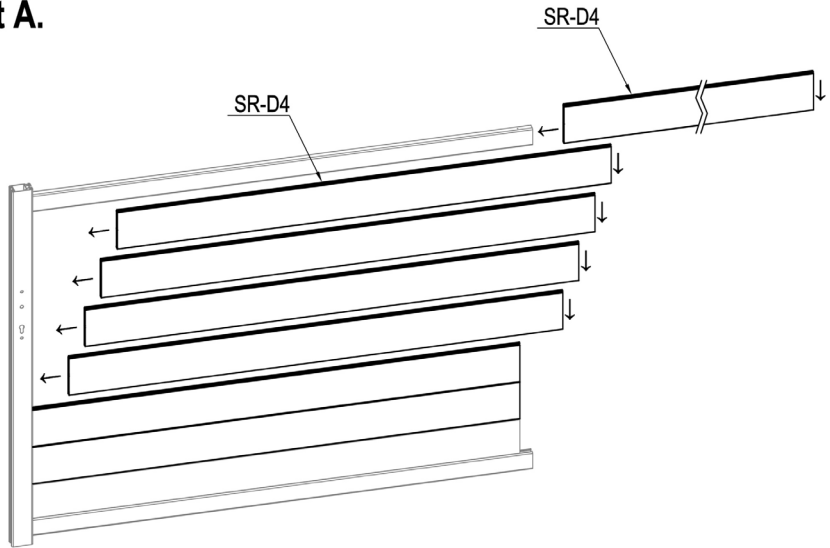

Part A.

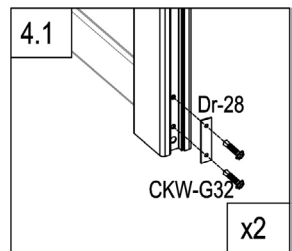
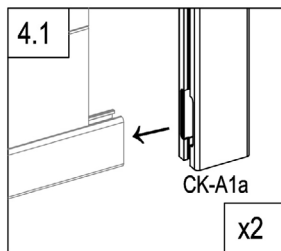
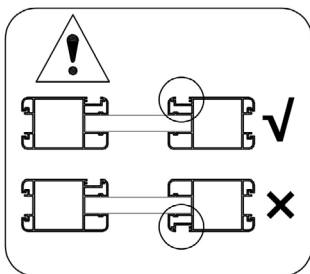
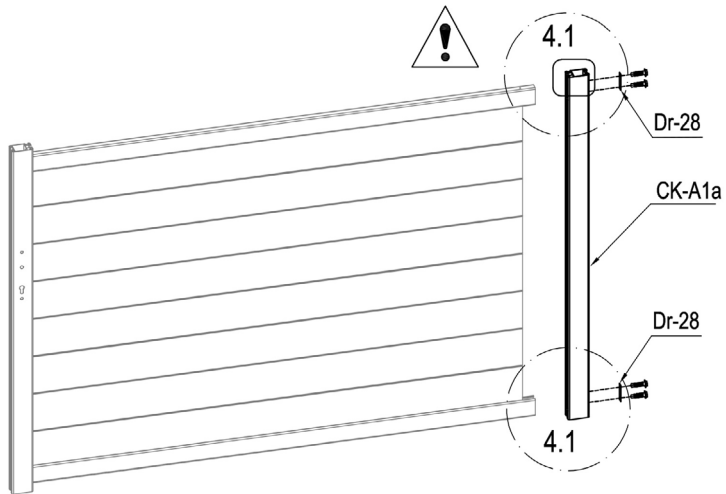

	SR-D4	7
---	-------	---

Part A.



	CK-A1a	1
	Dr-28	2
	CKW-G32	4

Part A.

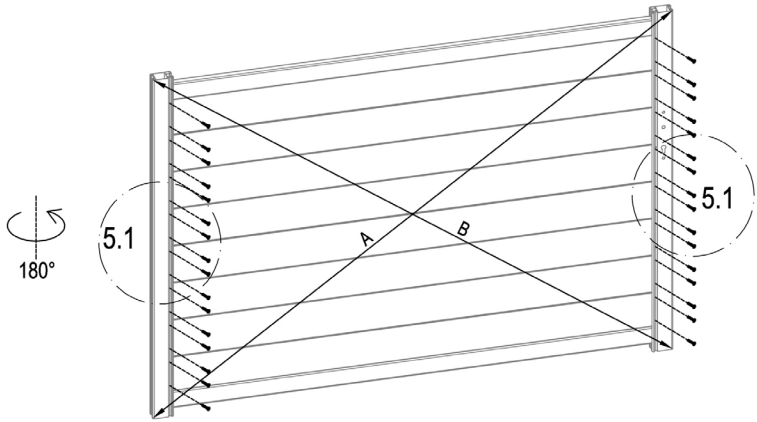

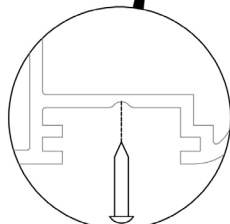
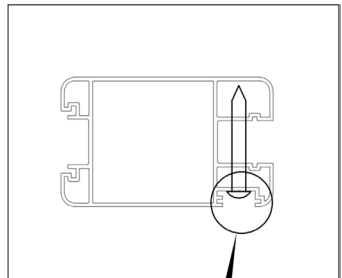
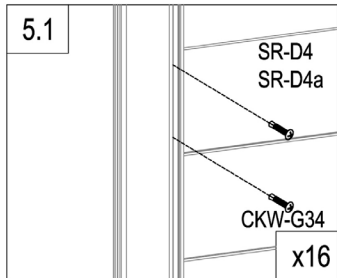

A=B

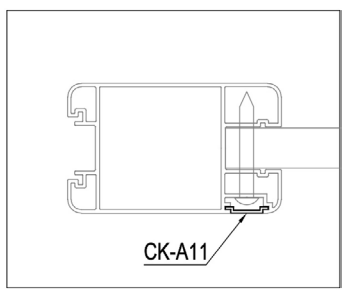
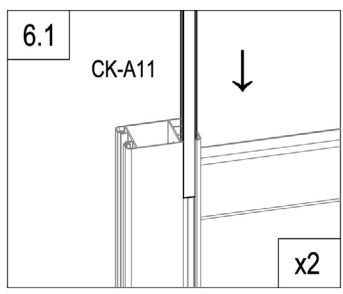
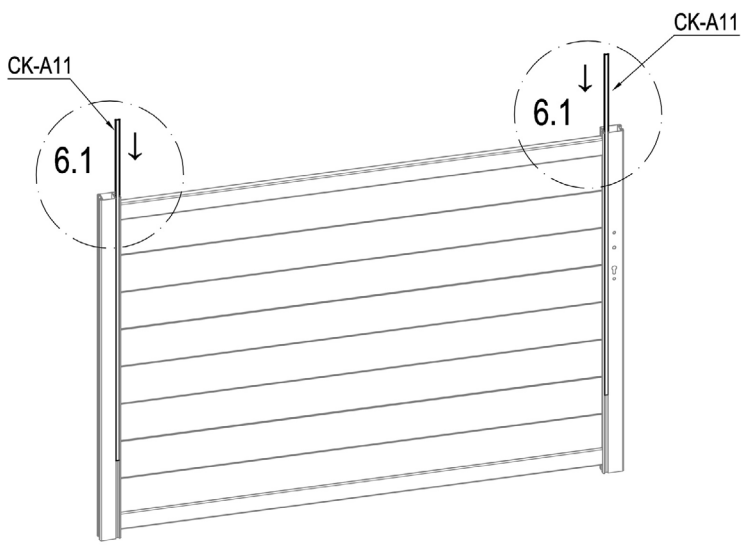

	CKW-G34	32
---	---------	----

Part A.



	CK-A11	2
---	--------	---

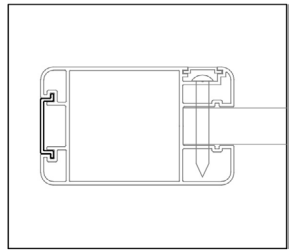
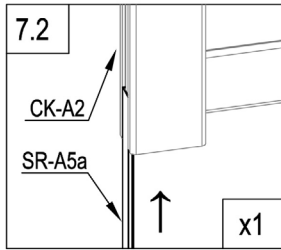
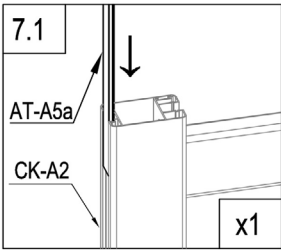
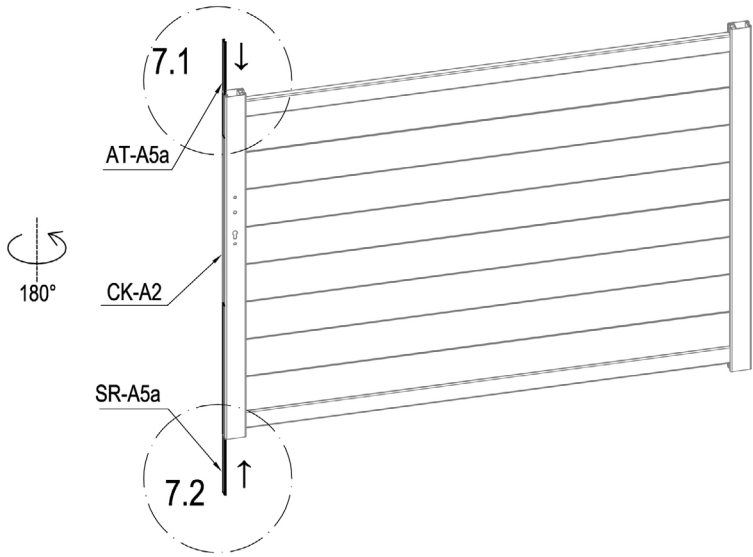

Part A.



	AT-A5a	1
	SR-A5a	1

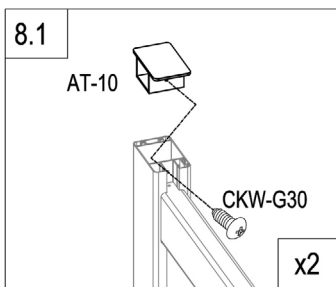
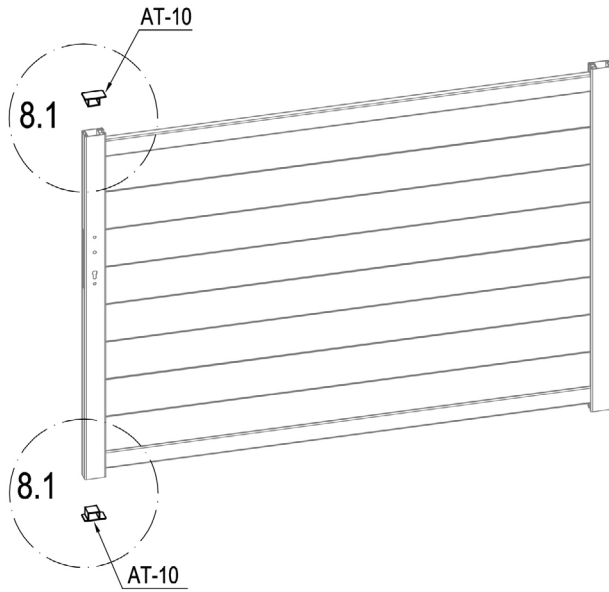



Part A.

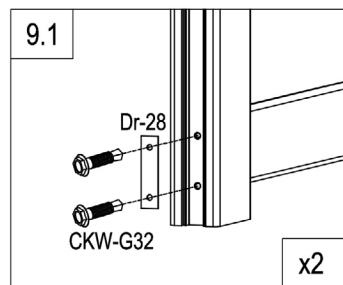
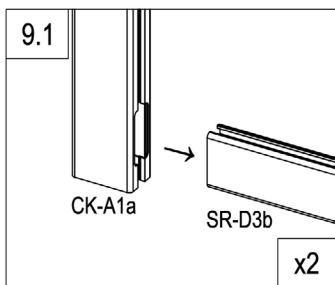
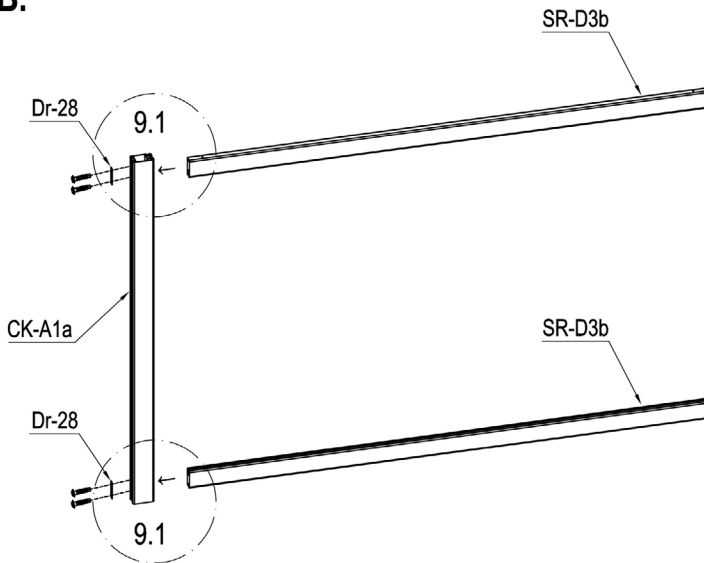

	AT-10	2
	CKW-G30	2

Part B.



	CK-A1a	1
	SR-D3b	2
	Dr-28	2
	CKW-G32	4

Part B.

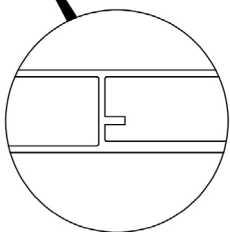
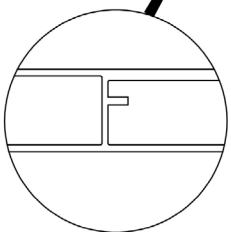
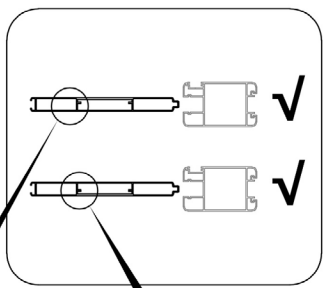
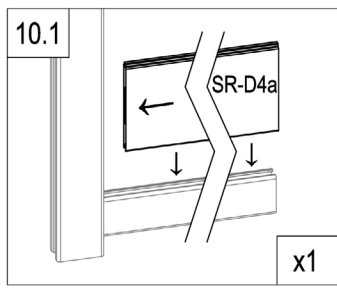
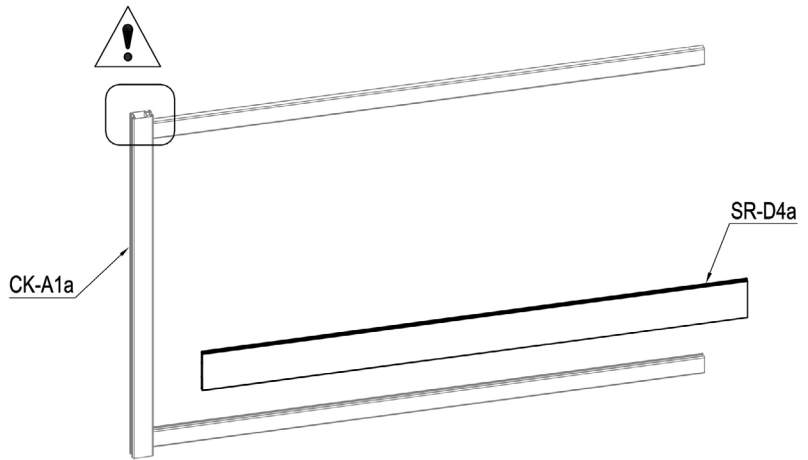

	SR-D4a	1
---	--------	---

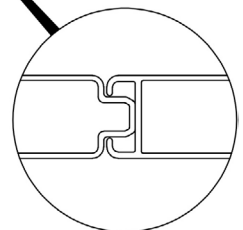
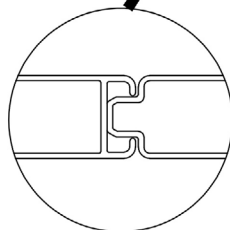
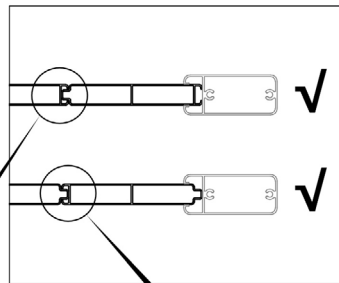
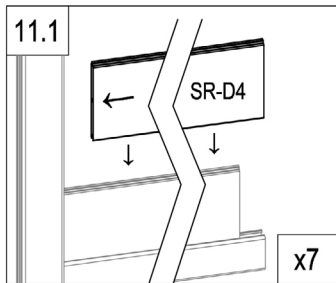
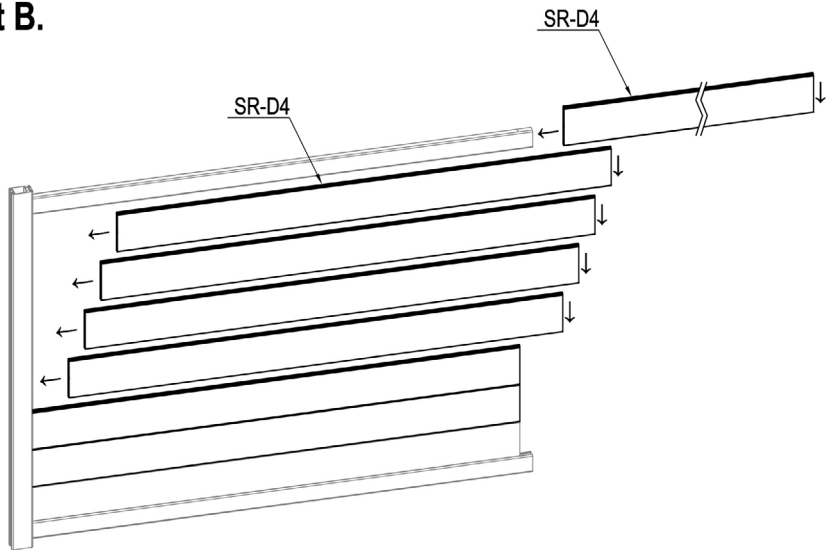

Part B.

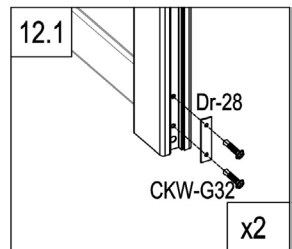
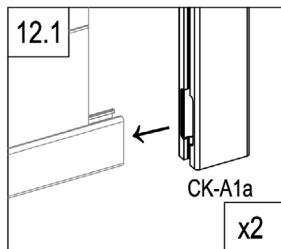
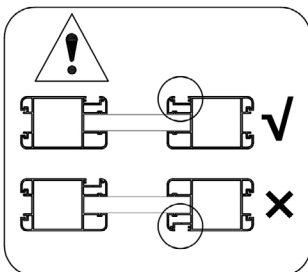
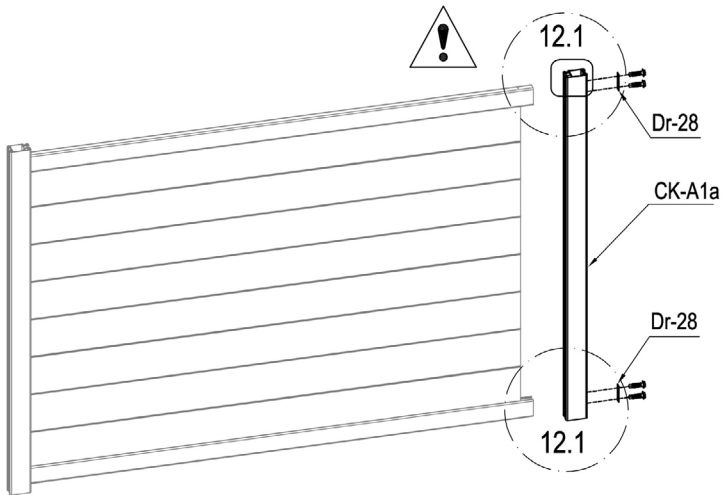

	SR-D4	7
---	-------	---

Part B.



	CK-A1a	1
	Dr-28	2
	CKW-G32	4

Part B.

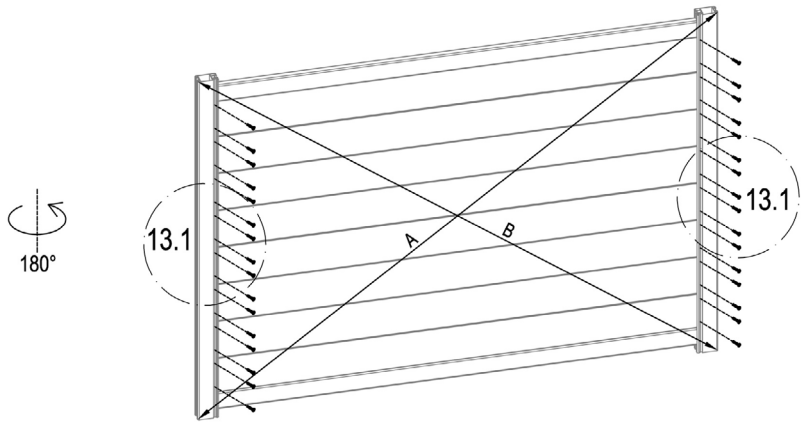

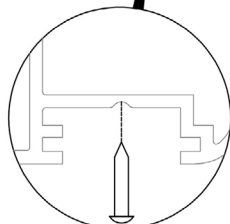
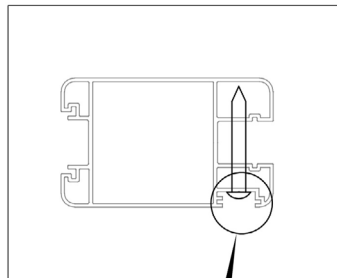
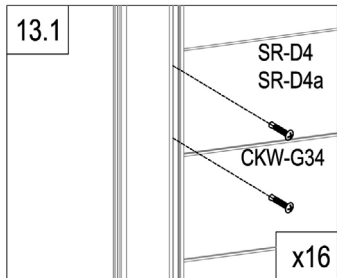

A=B



	CKW-G34	32
---	---------	----

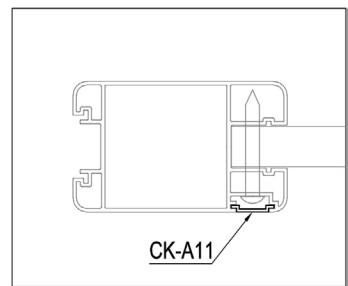
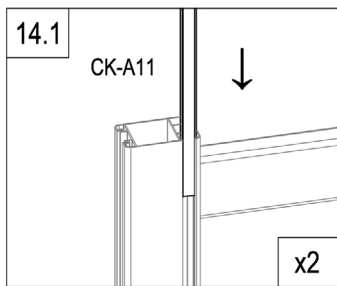
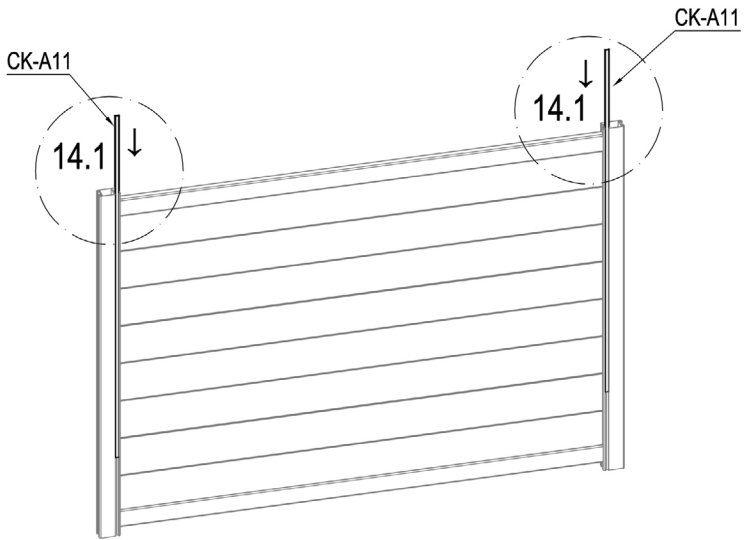



Part B.

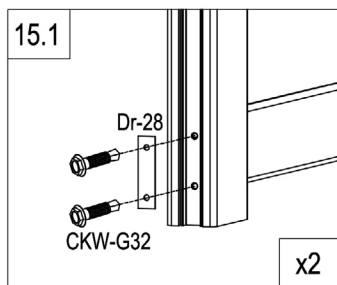
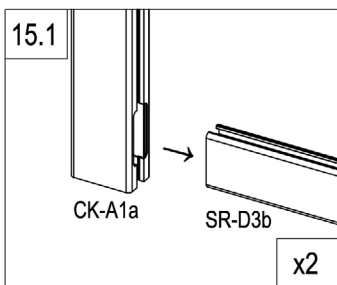
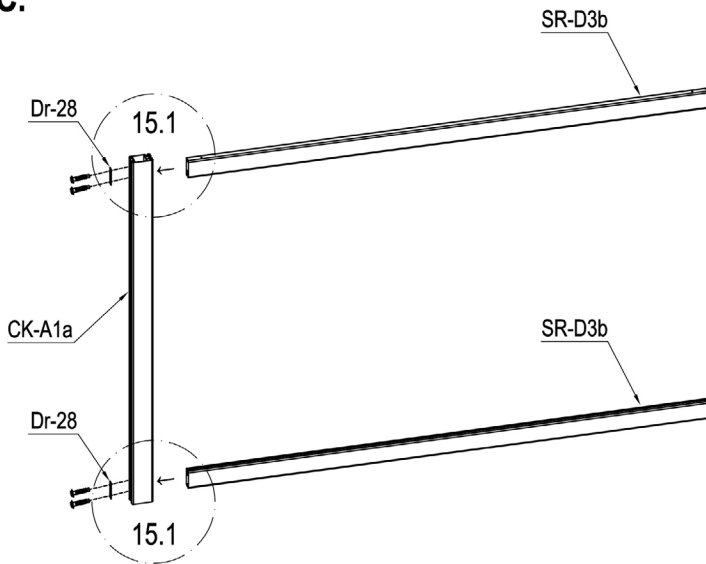

	CK-A11	2
---	--------	---

Part C.



	CK-A1a	1
	SR-D3b	2
	Dr-28	2
	CKW-G32	4

Part C.

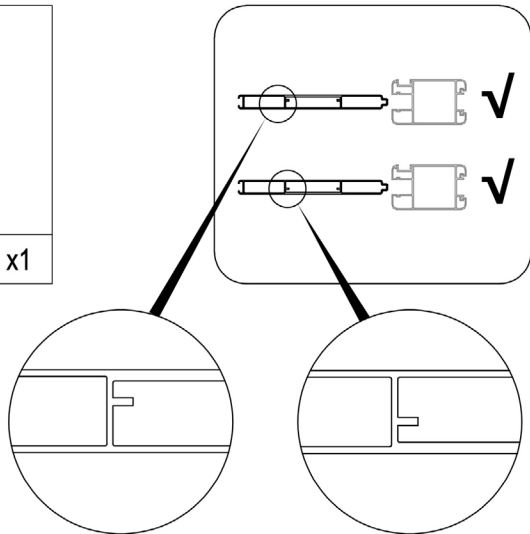
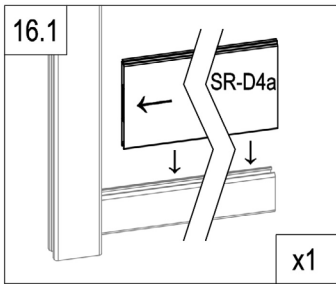
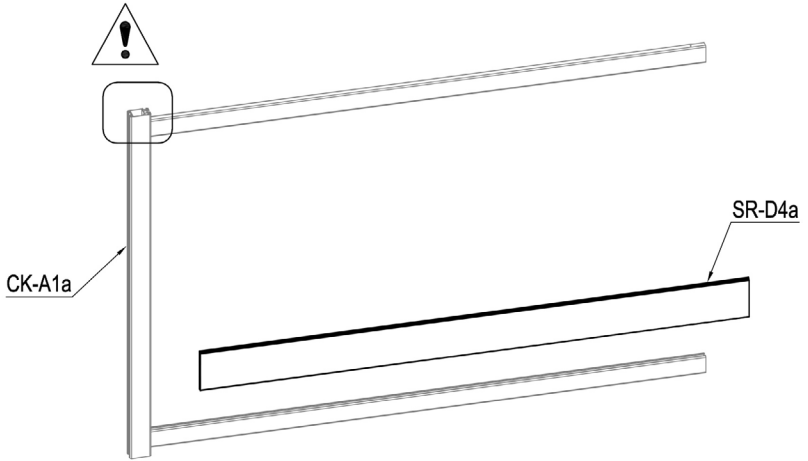

	SR-D4a	1
---	--------	---

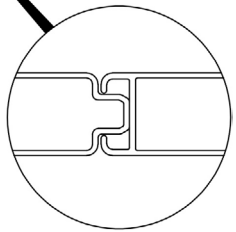
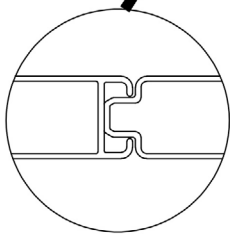
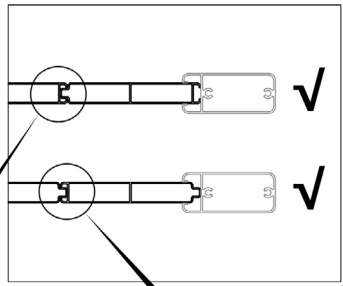
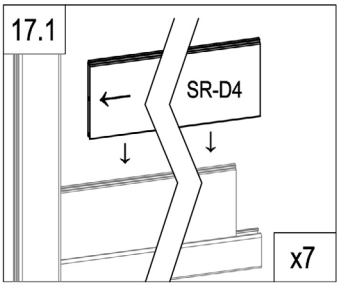
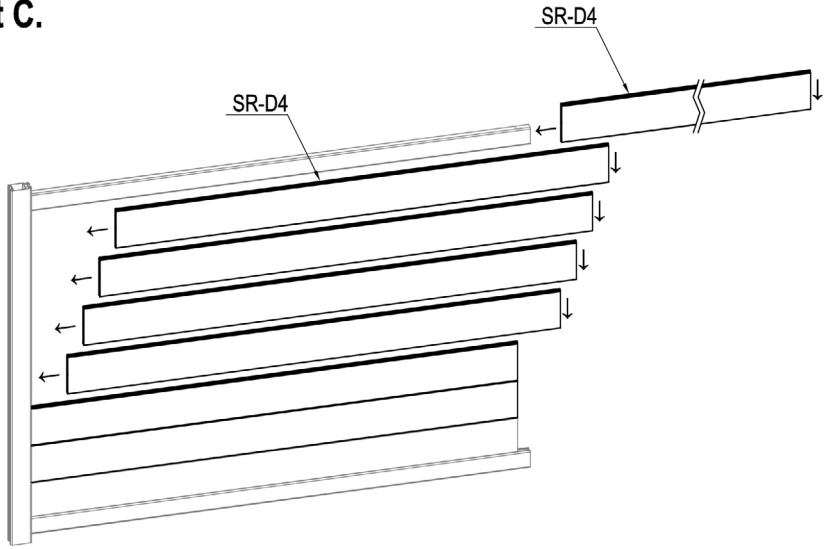

Part C.

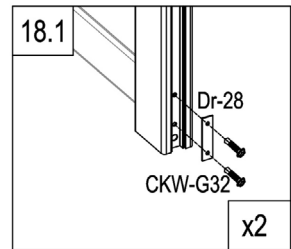
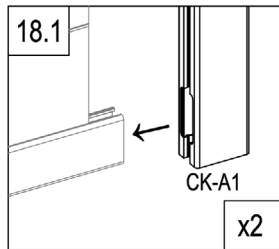
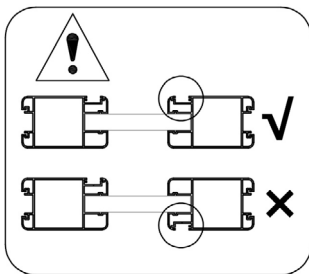
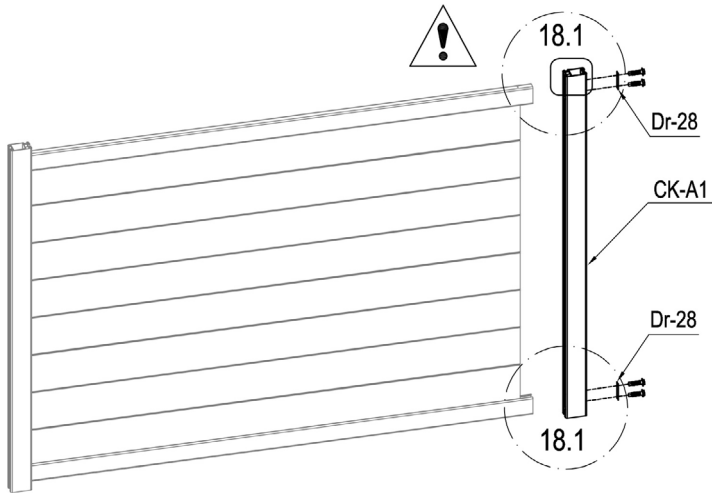

	SR-D4	7
---	-------	---

Part C.



	CK-A1	1
	Dr-28	2
	CKW-G32	4

Part C.

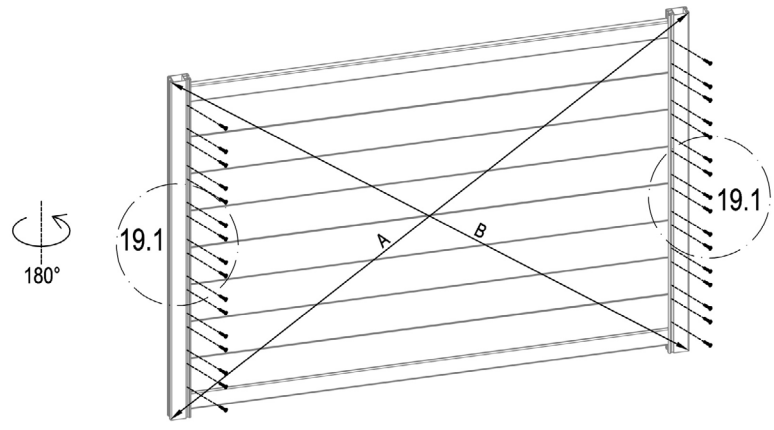

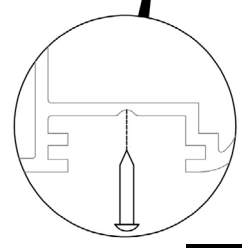
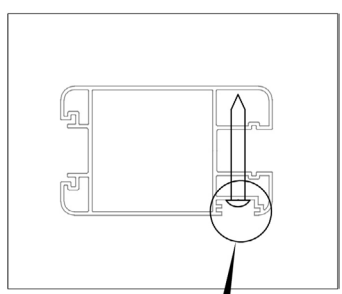
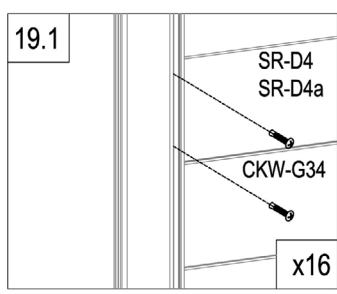

A=B

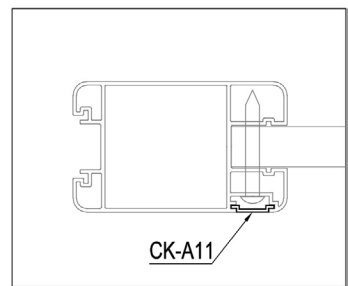
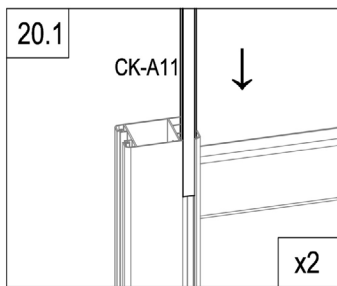
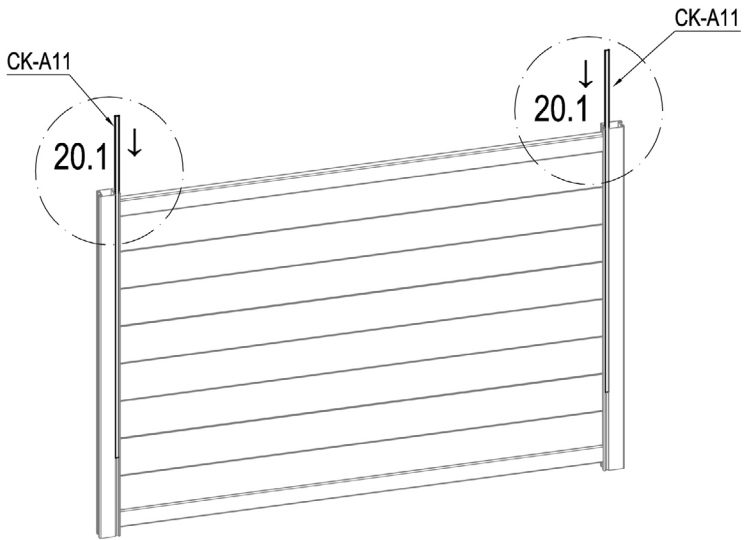

	CKW-G34	32
---	---------	----

Part C.



	CK-A11	2
---	--------	---

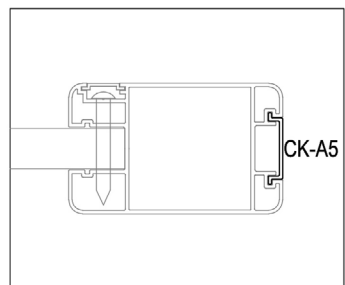
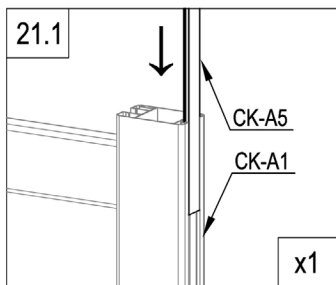
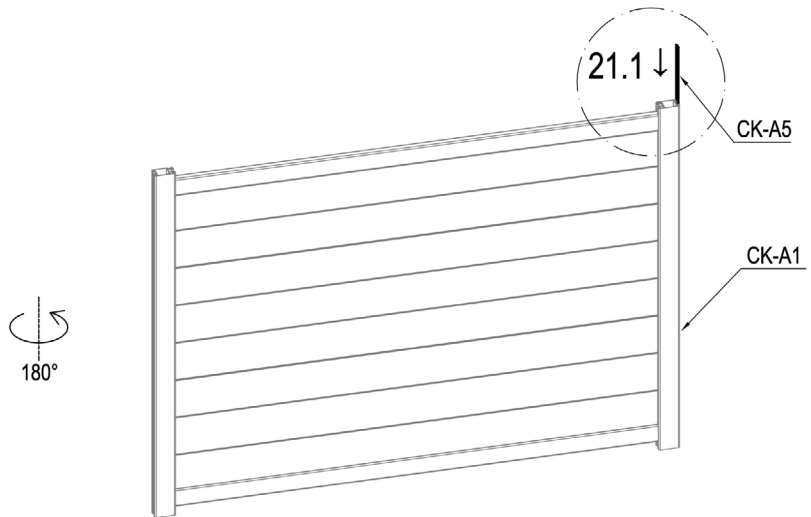

Part C.

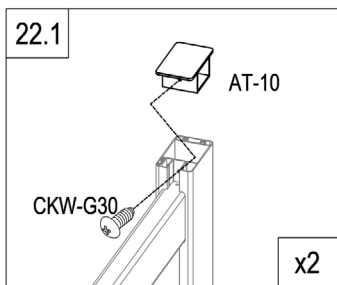
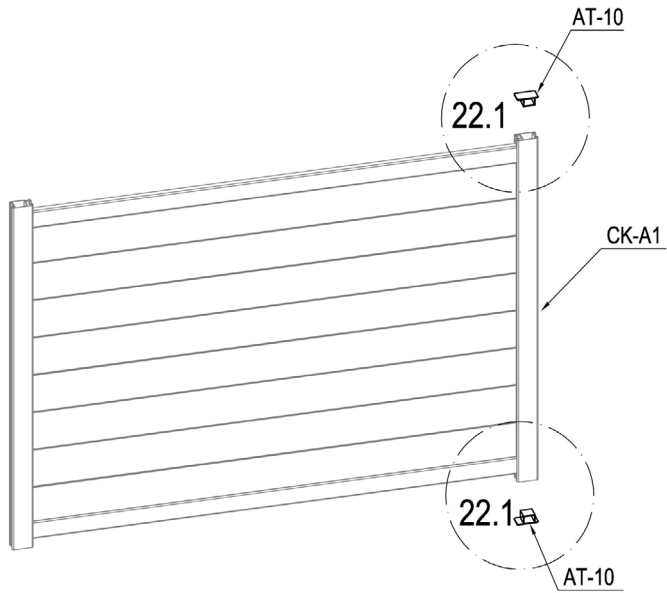

]	CK-A5	1
---	-------	---

Part C.



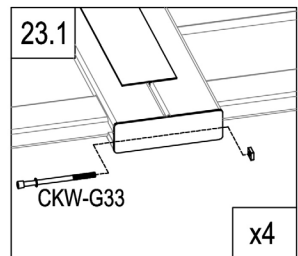
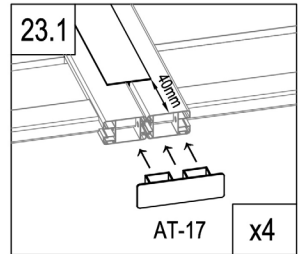
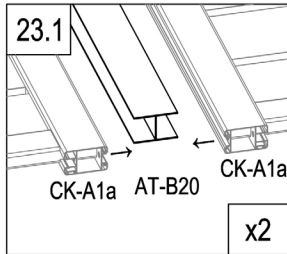
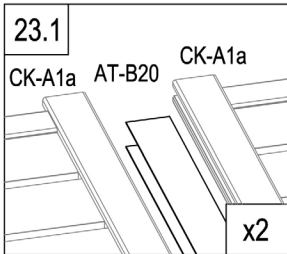
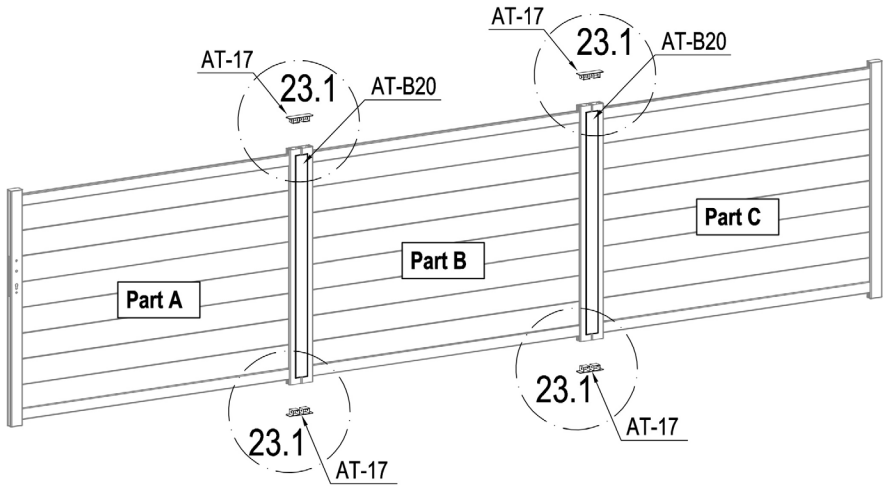

	AT-10	2
	CKW-G30	2

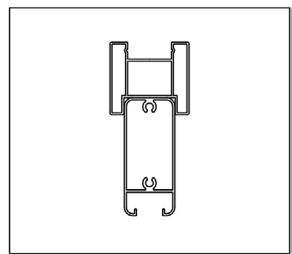
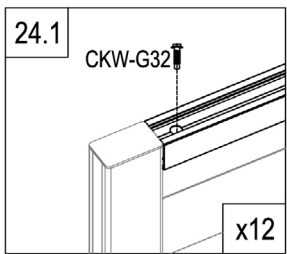
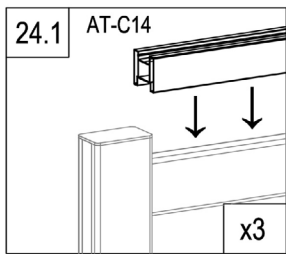
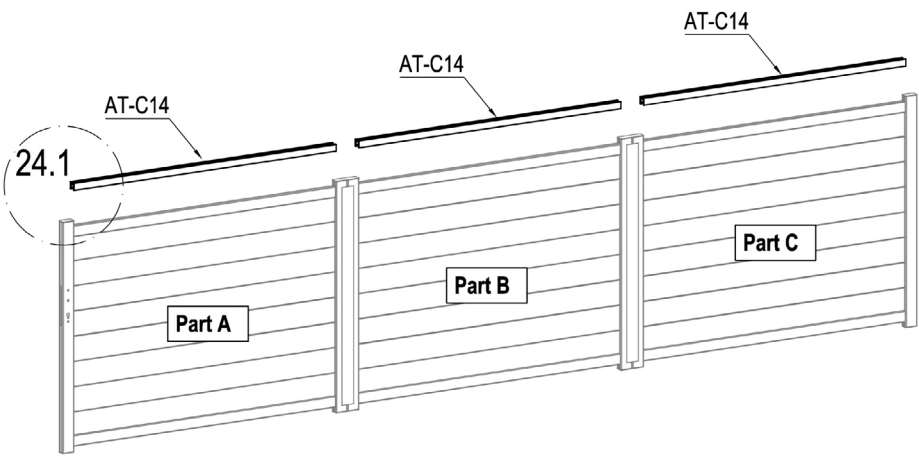

	AT-B20	2
	AT-17	4
	CKW-G33	4



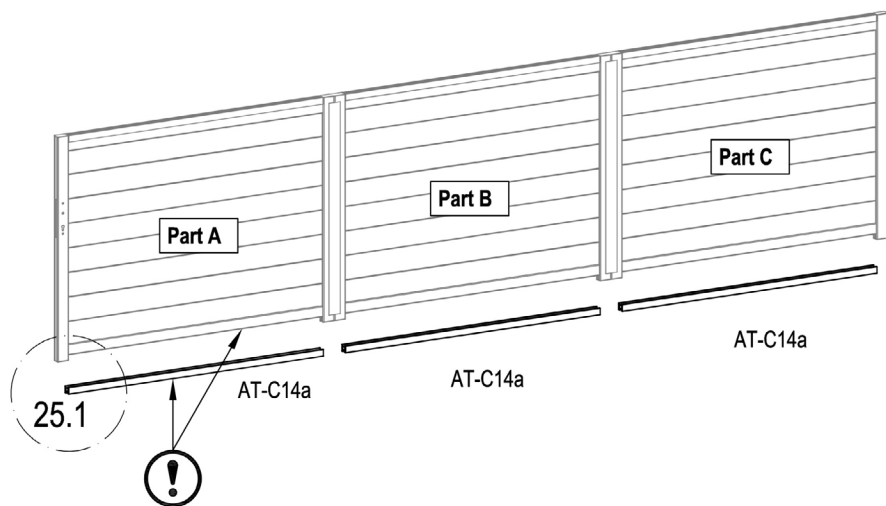

	AT-C14	3
	CKW-G32	12

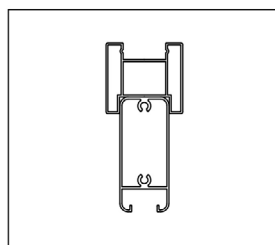
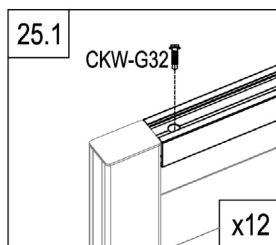
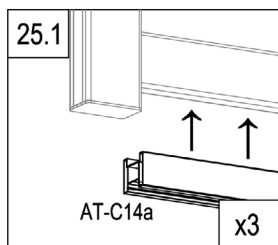

EN: These parts are made for connecting your gate's automation
 FR: Ces pièces sont faites pour relier l'automatisation de votre portail
 DE: Diese Teile sind für den Anschluss der Automatisierung Ihres Tores vorgesehen
 ES: Estas piezas están hechas para conectar la automatización de su puerta
 PT: Estas peças são feitas para ligar a automatização do seu portão
 IT: Queste parti sono realizzate per collegare l'automazione del vostro cancello
 NL: Deze onderdelen zijn gemaakt voor het aansluiten van de automatisering van uw poort.
 PL: Te części są wykonane do podłączenia automatyki bramy.



	AT-C14a	3
	CKW-G32	12

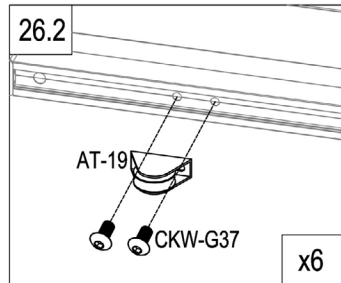
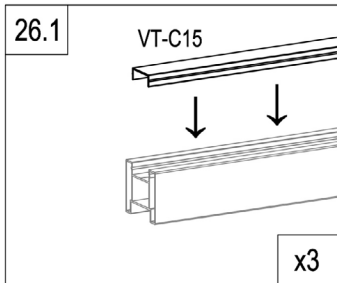
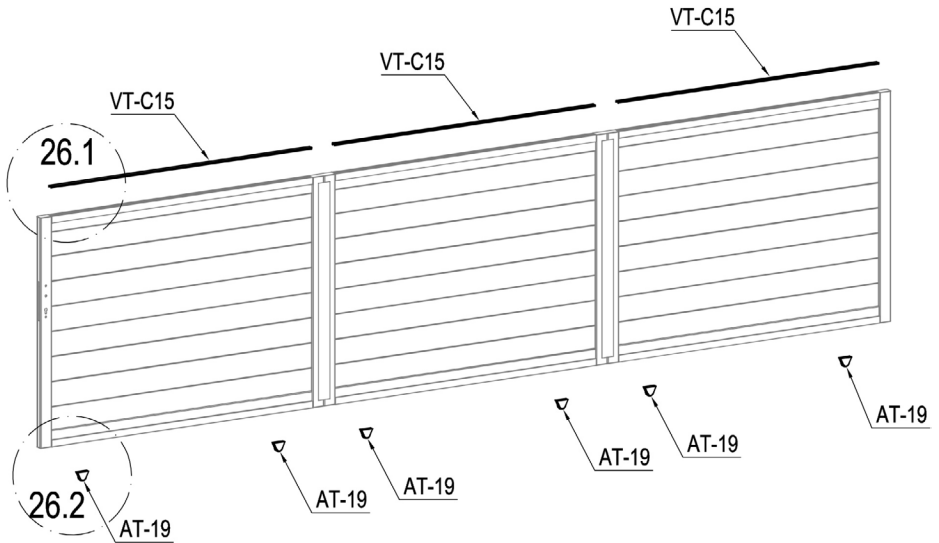

	VT-C15	3
	AT-19	6
	CKW-G37	12

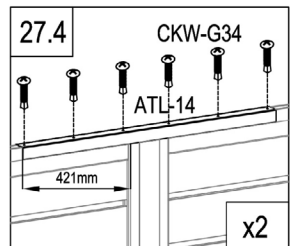
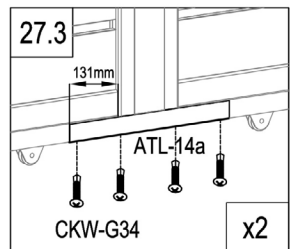
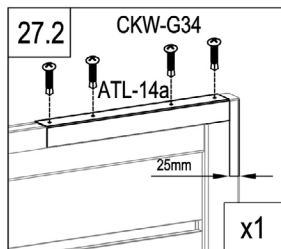
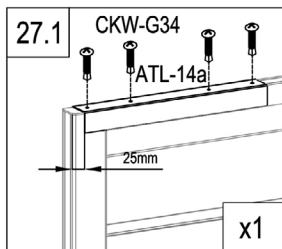
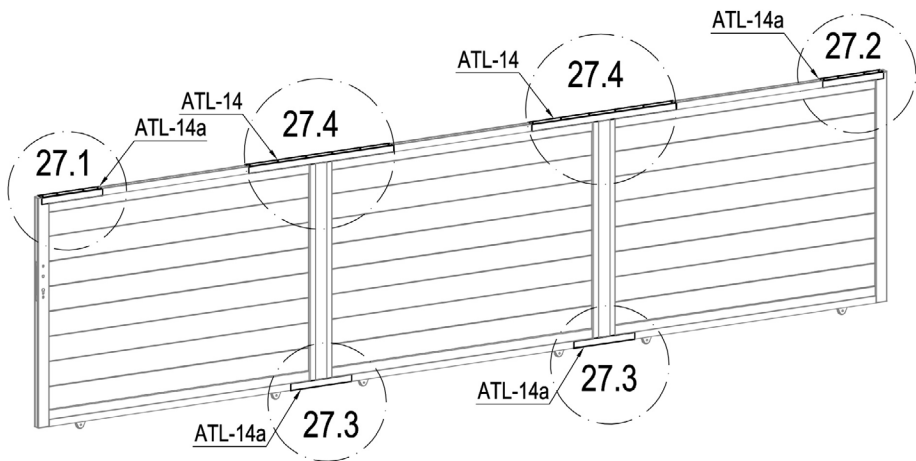

	ATL-14	2
	ATL-14a	4
	CKW-G34	28

Ext.

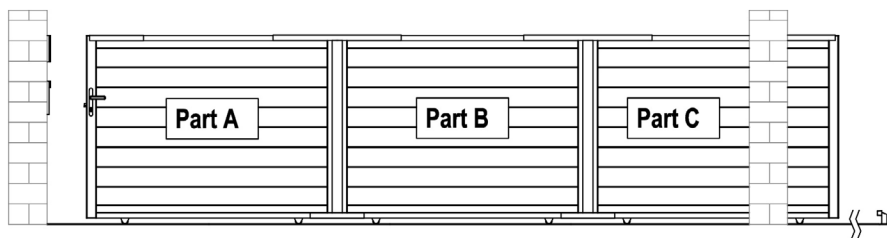

Int.

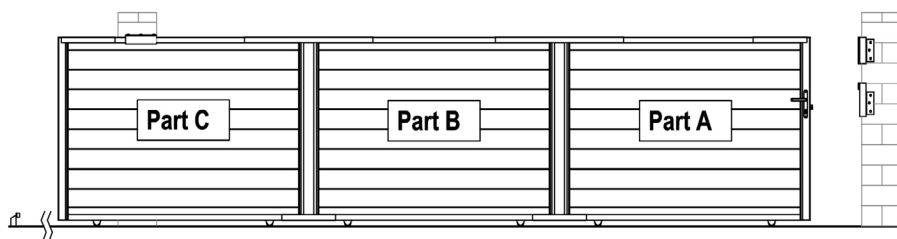

Ext.

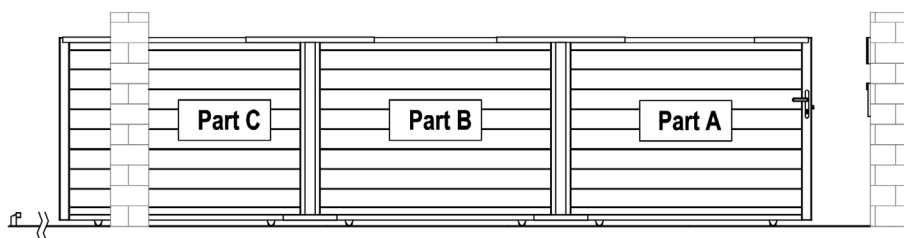

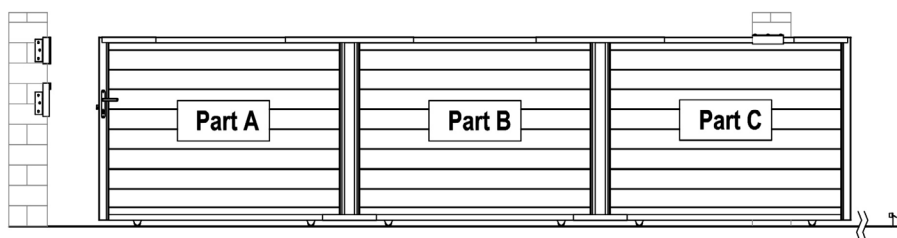

Int.

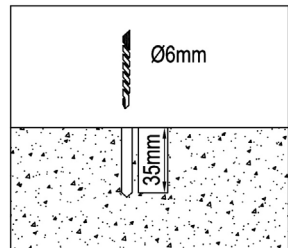
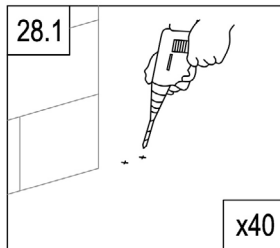
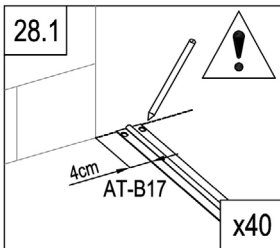
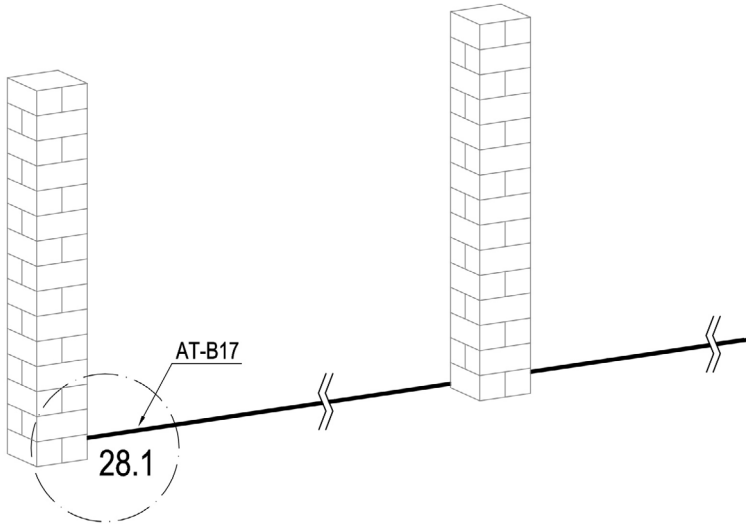

R

L



	AT-B17	8
	CKW-G38	80

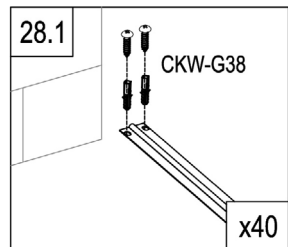

L

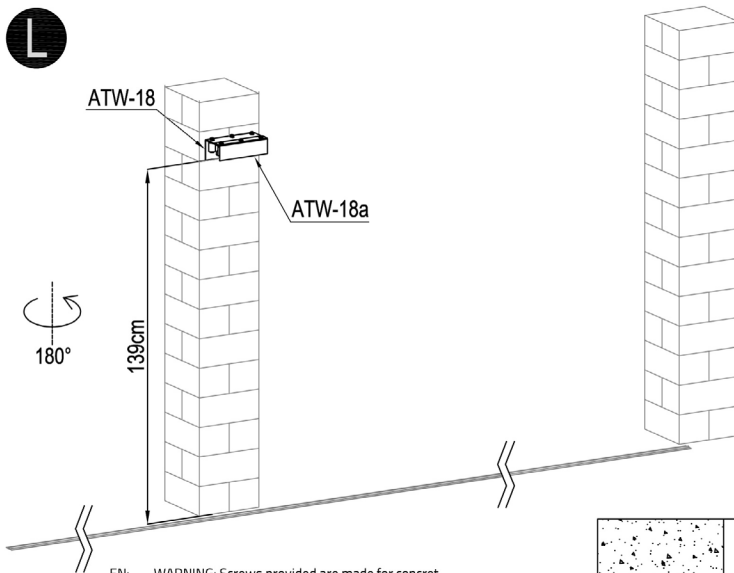

EN: WARNING: Screws provided are made for concret.
 FR: AVERTISSEMENT : Les vis fournies sont faites pour le béton.
 DE: WARNUNG: Die mitgelieferten Schrauben sind für Beton ausgelegt.
 ES: ADVERTENCIA: Los tornillos suministrados están hechos para el hormigón.
 IT: ATTENZIONE: Le viti fornite sono fatte per il calcestruzzo.
 NL: WAARSCHUWING: De bijgeleverde schroeven zijn gemaakt voor beton.
 PL: OSTRZEŻENIE: Dostarczone śruby są przeznaczone do betonu.
 PT: AVISO: Os parafusos fornecidos são feitos para betão.

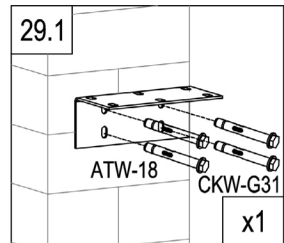
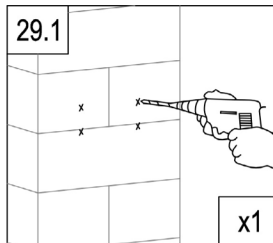
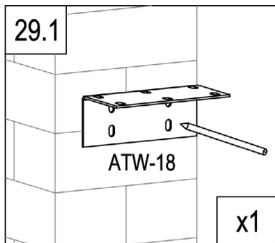
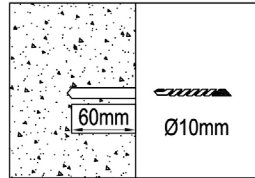

	ATW-18	1
	ATW-18a	1
	AT-20	6
	CKW-G31	4

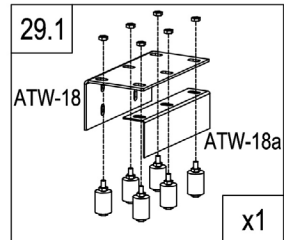
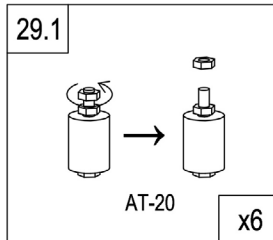

L

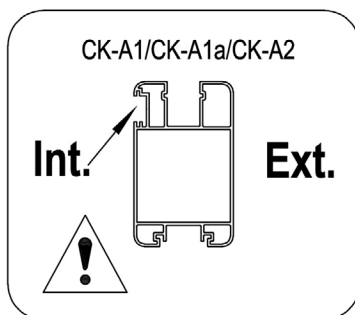
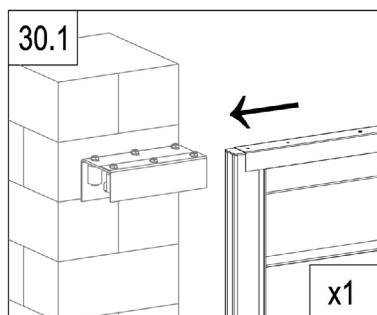
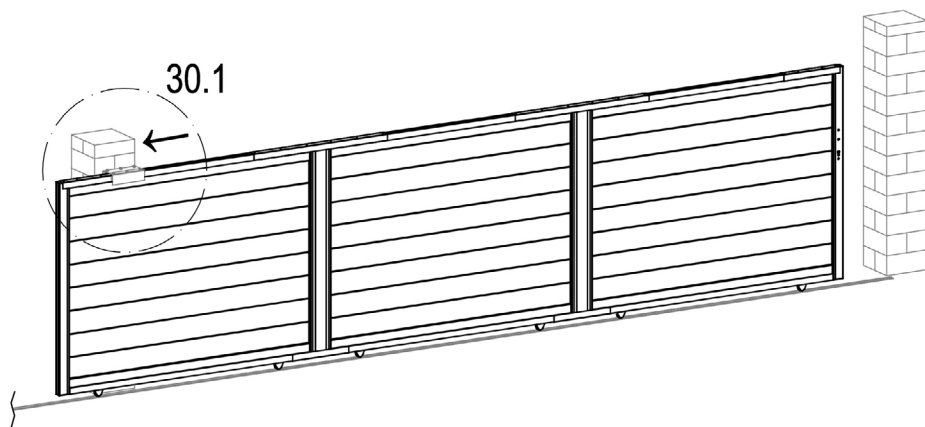

L

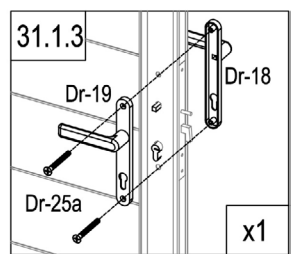
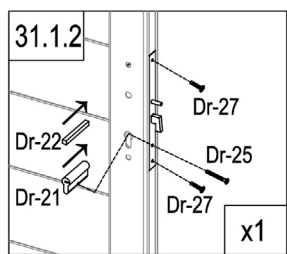
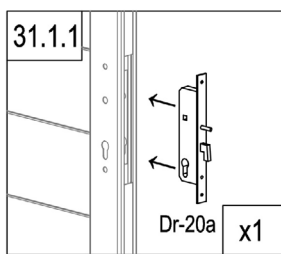
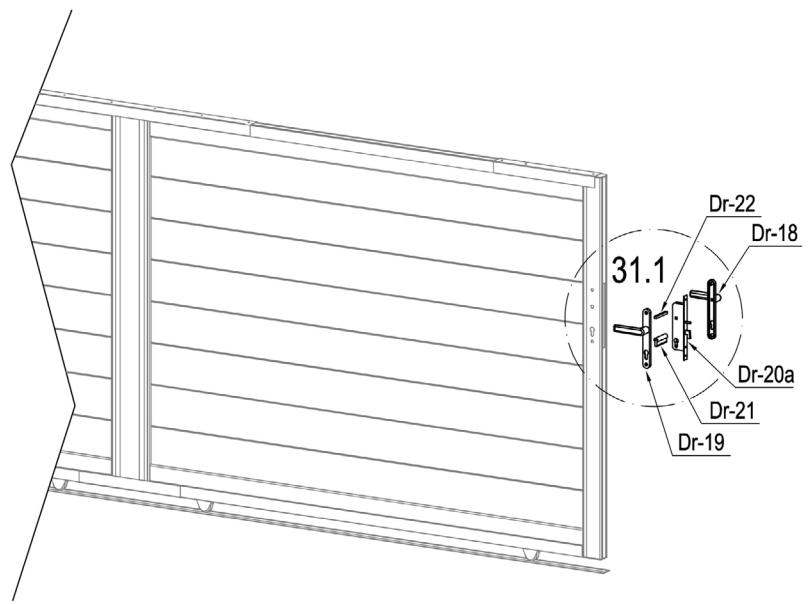

	Dr-20a	1
	Dr-21	1
	Dr-22	1
	Dr-25	1

	Dr-18	1
	Dr-19	1
	Dr-25a	2
	Dr-27	2



EN: WARNING: Screws provided are made for concret.
 FR: AVERTISSEMENT : Les vis fournies sont faites pour le béton.
 DE: WARNUNG: Die mitgelieferten Schrauben sind für Beton ausgelegt.
 ES: ADVERTENCIA: Los tornillos suministrados están hechos para el hormigón.
 IT: ATTENZIONE: Le viti fornite sono fatte per il calcestruzzo.
 NL: WAARSCHUWING: De bijgeleverde schroeven zijn gemaakt voor beton.
 PL: OSTRZEŻENIE: Dostarczone śruby są przeznaczone do betonu.
 PT: AVISO: Os parafusos fornecidos são feitos para betão.

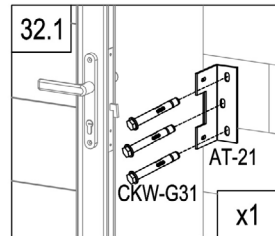
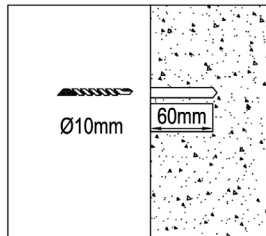
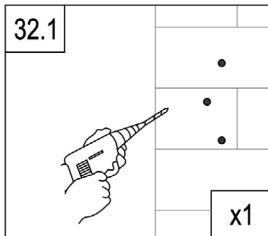
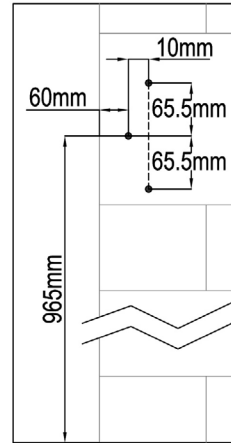
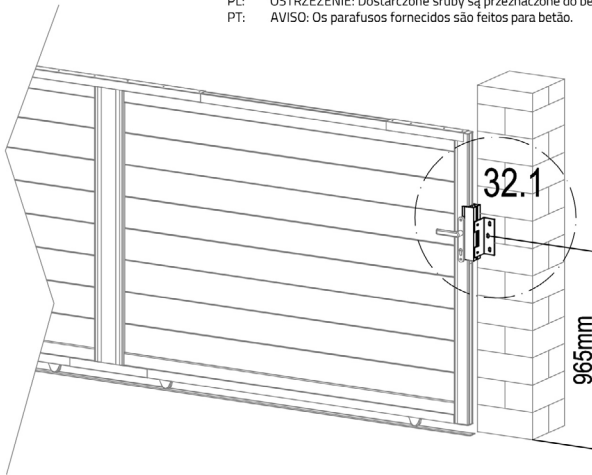

	AT-16	1
	AT-21	1
	CKW-G36	2
	CKW-G31	3
	ATW-22J	3

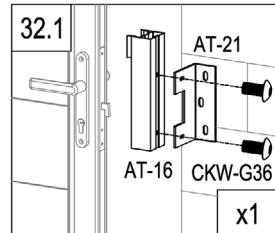
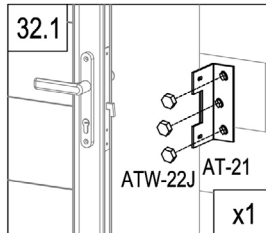

L

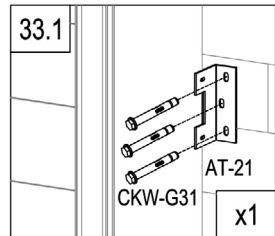
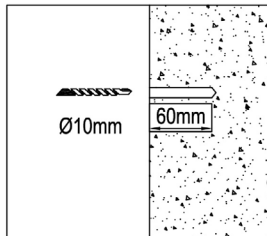
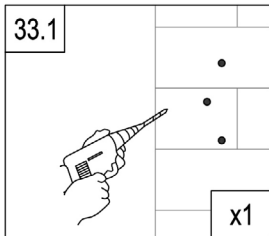
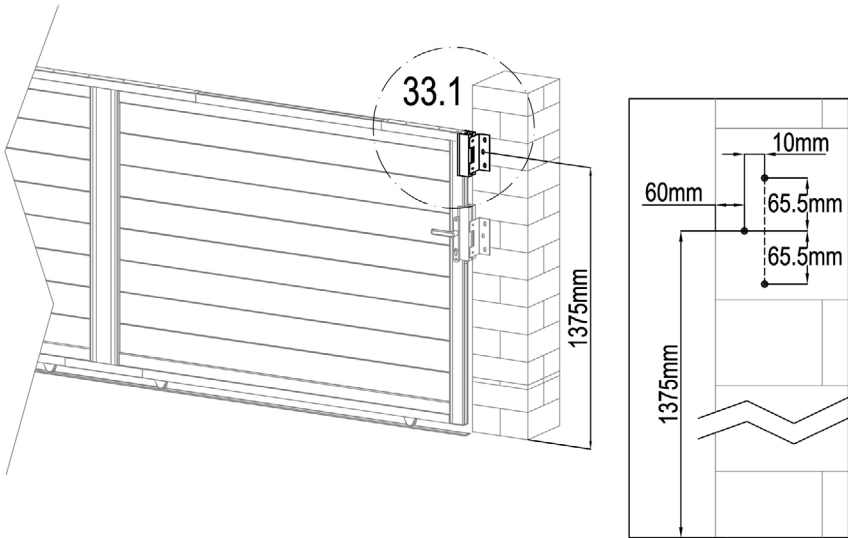

	AT-16a	1
	AT-21	1
	CKW-G36	2
	CKW-G31	3
	ATW-22J	3

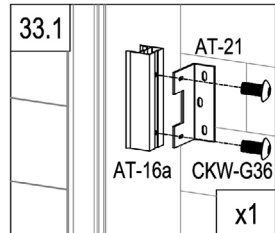
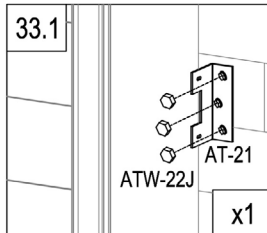

L

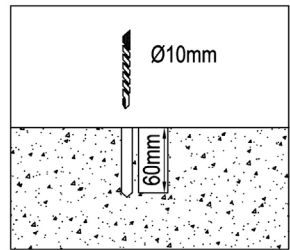
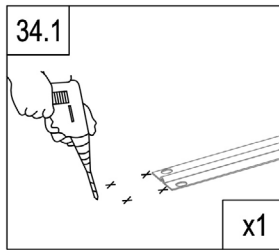
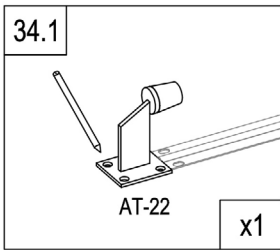
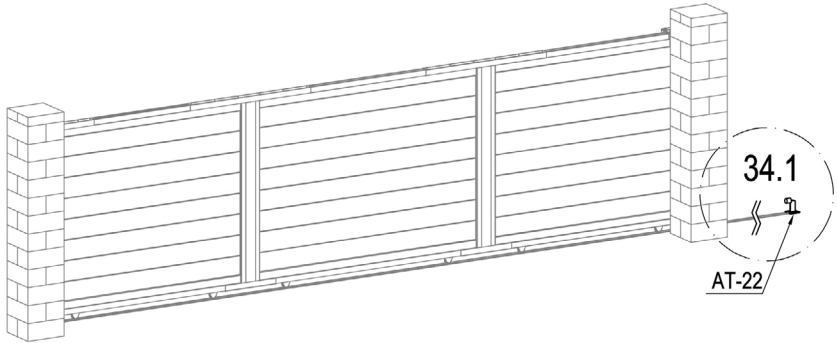

	AT-22	1
	CKW-G31	4
	ATW-22J	4

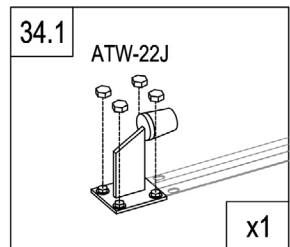
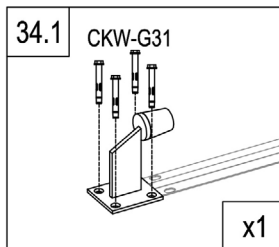

R

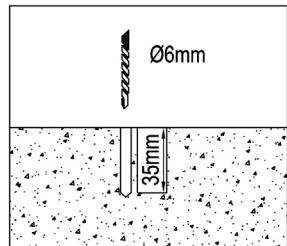
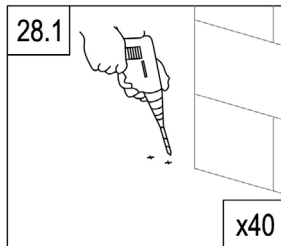
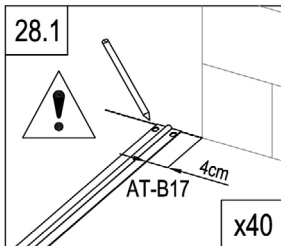
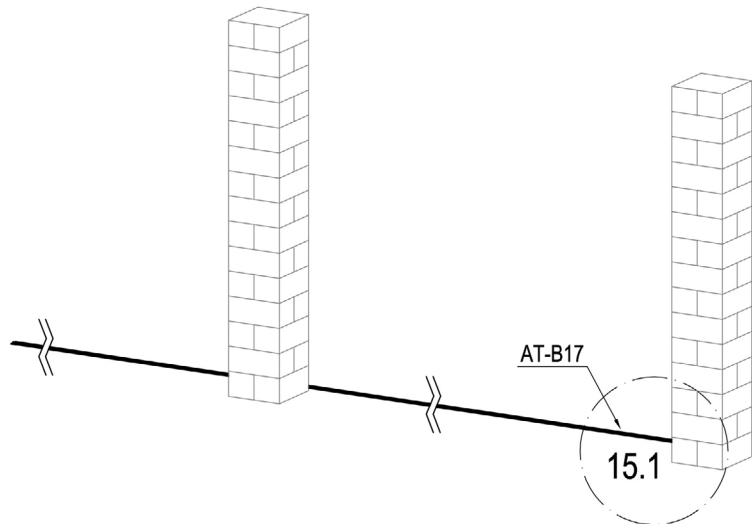

	AT-B17	8
	CKW-G38	80

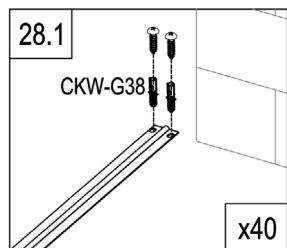

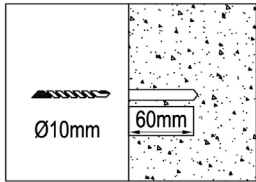
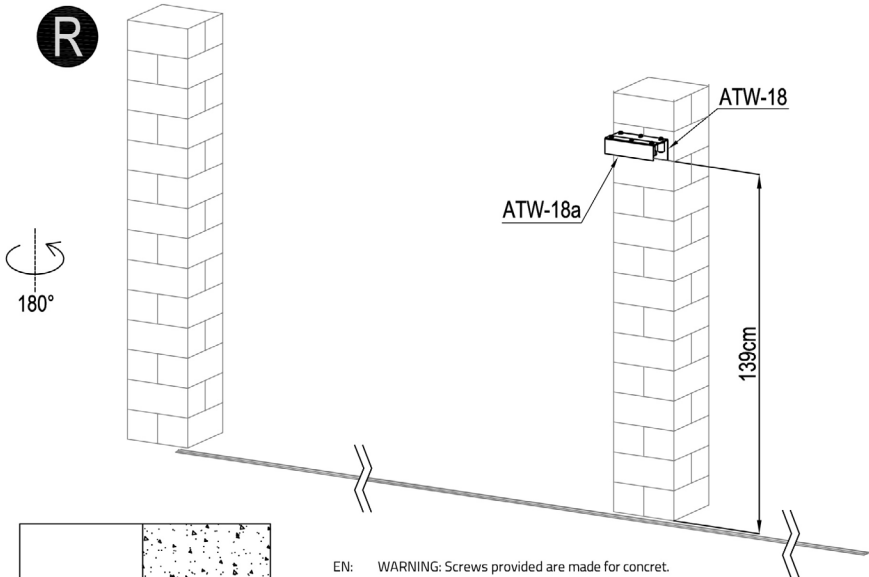

- EN: WARNING: Screws provided are made for concrete.
 FR: AVERTISSEMENT : Les vis fournies sont faites pour le béton.
 DE: WARNUNG: Die mitgelieferten Schrauben sind für Beton ausgelegt.
 ES: ADVERTENCIA: Los tornillos suministrados están hechos para el hormigón.
 IT: ATTENZIONE: Le viti fornite sono fatte per il calcestruzzo.
 NL: WAARSCHUWING: De bijgeleverde schroeven zijn gemaakt voor beton.
 PL: OSTRZEŻENIE: Dostarczone śruby są przeznaczone do betonu.
 PT: AVISO: Os parafusos fornecidos são feitos para betão.

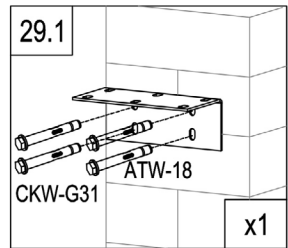
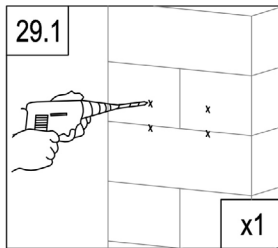
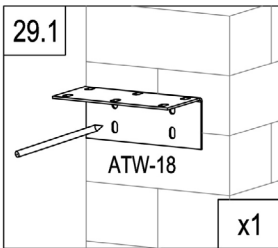

	ATW-18	1
	ATW-18a	1
	AT-20	6
	CKW-G31	4

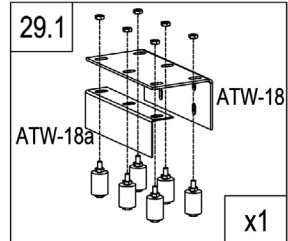
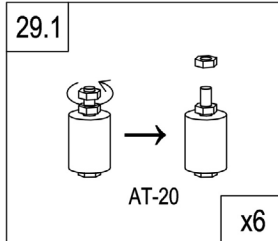

R

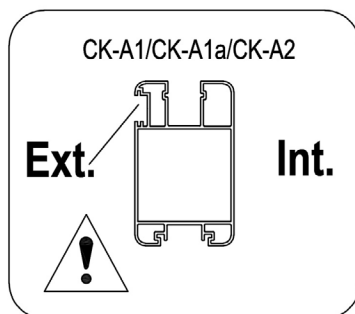
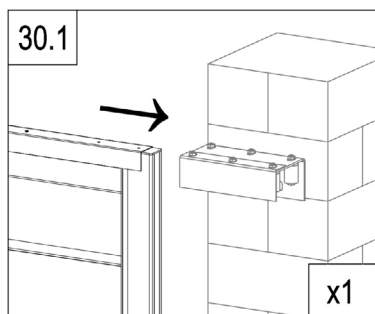
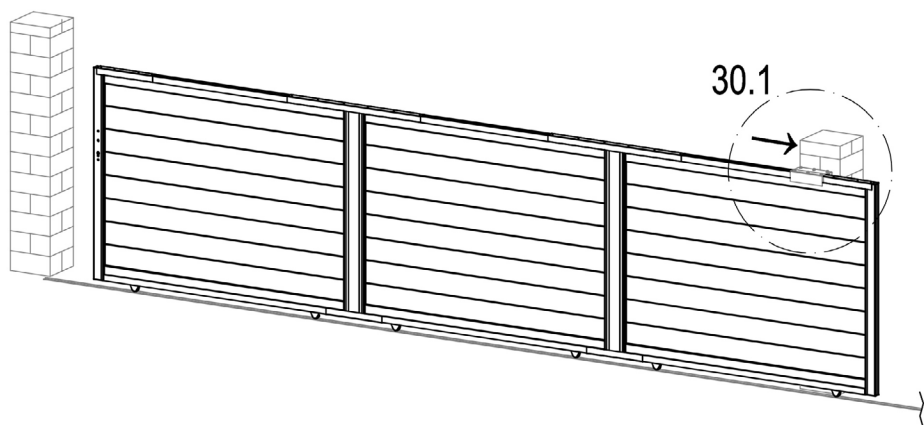

R

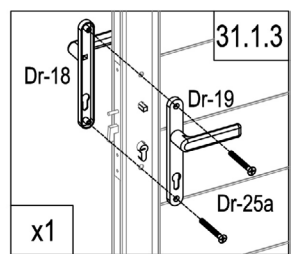
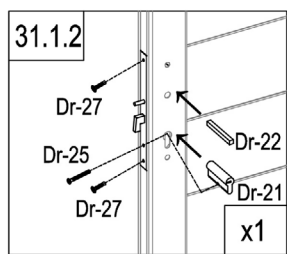
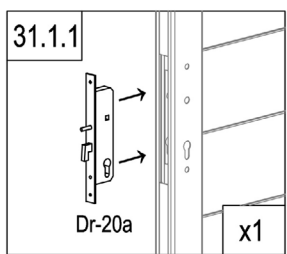
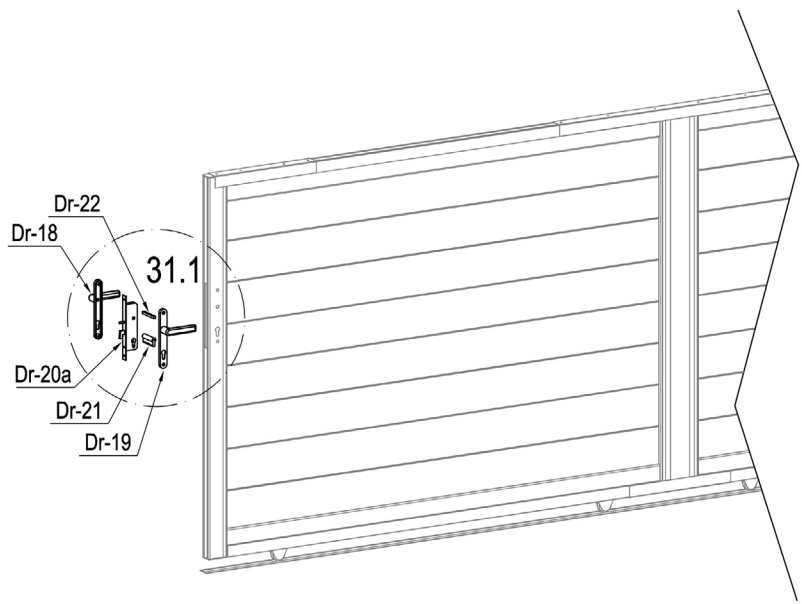

	Dr-20a	1
	Dr-21	1
	Dr-22	1
	Dr-25	1

	Dr-18	1
	Dr-19	1
	Dr-25a	2
	Dr-27	2



EN: WARNING: Screws provided are made for concret.
 FR: AVERTISSEMENT : Les vis fournies sont faites pour le béton.
 DE: WARNUNG: Die mitgelieferten Schrauben sind für Beton ausgelegt.
 ES: ADVERTENCIA: Los tornillos suministrados están hechos para el hormigón.
 IT: ATTENZIONE: Le viti fornite sono fatte per il calcestruzzo.
 NL: WAARSCHUWING: De bijgeleverde schroeven zijn gemaakt voor beton.
 PL: OSTRZEZENIE: Dostarczone śruby są przeznaczone do betonu.
 PT: AVISO: Os parafusos fornecidos são feitos para betão.

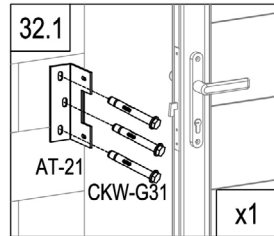
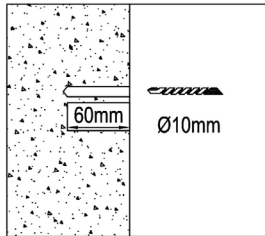
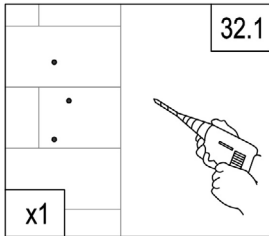
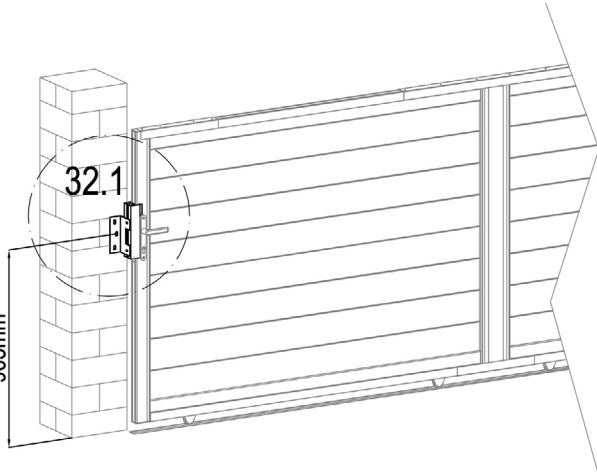
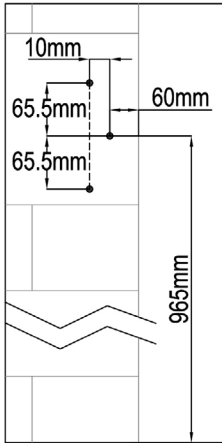

	AT-16	1
	AT-21	1
	CKW-G36	2
	CKW-G31	3
	ATW-22J	3

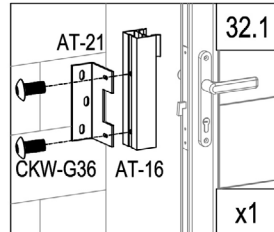
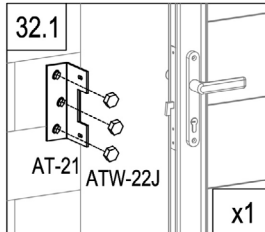

R

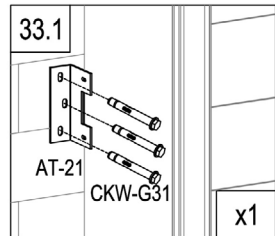
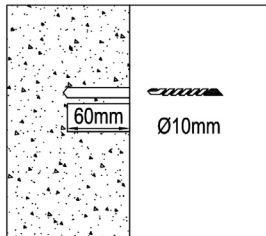
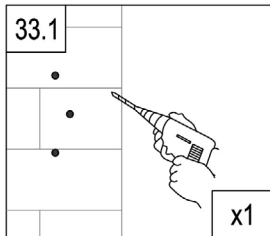
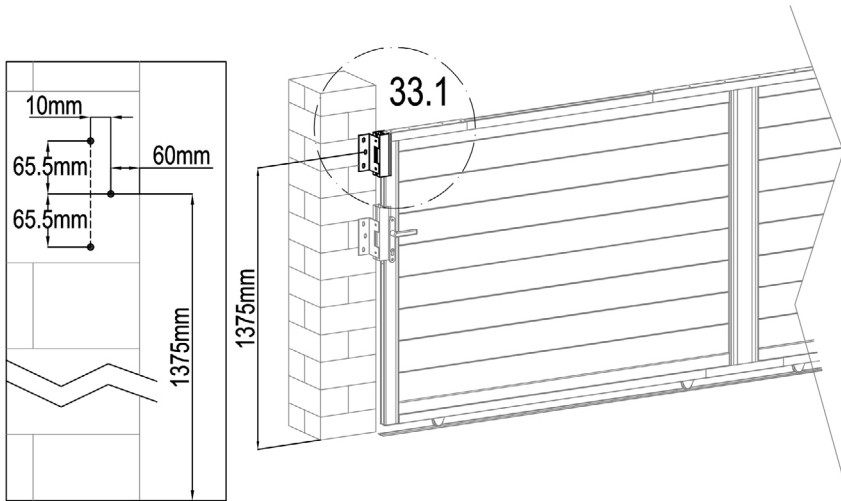

	AT-16a	1
	AT-21	1
	CKW-G36	2
	CKW-G31	3
	ATW-22J	3

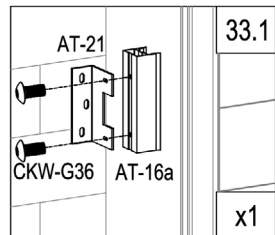
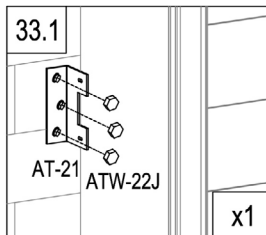

R

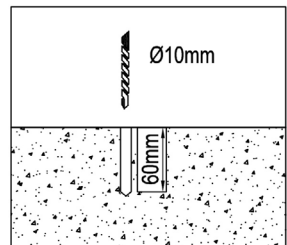
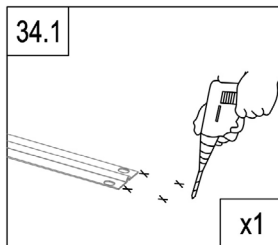
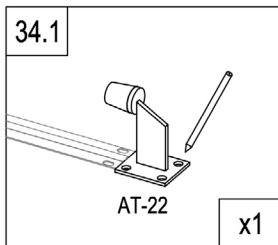
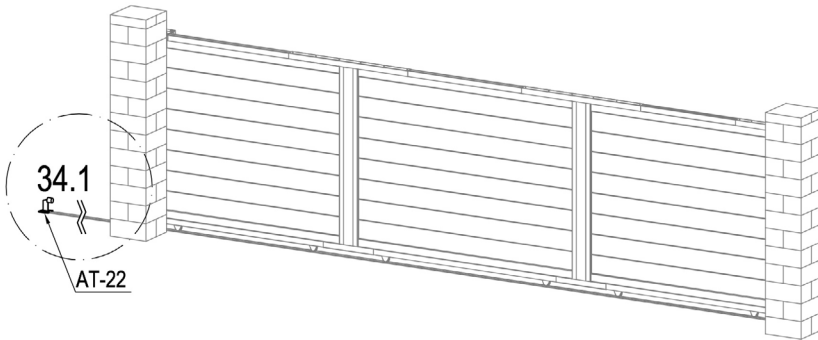

	AT-22	1
	CKW-G31	4
	ATW-22J	4

