

# CASANOVO

## SANTIS 340B140

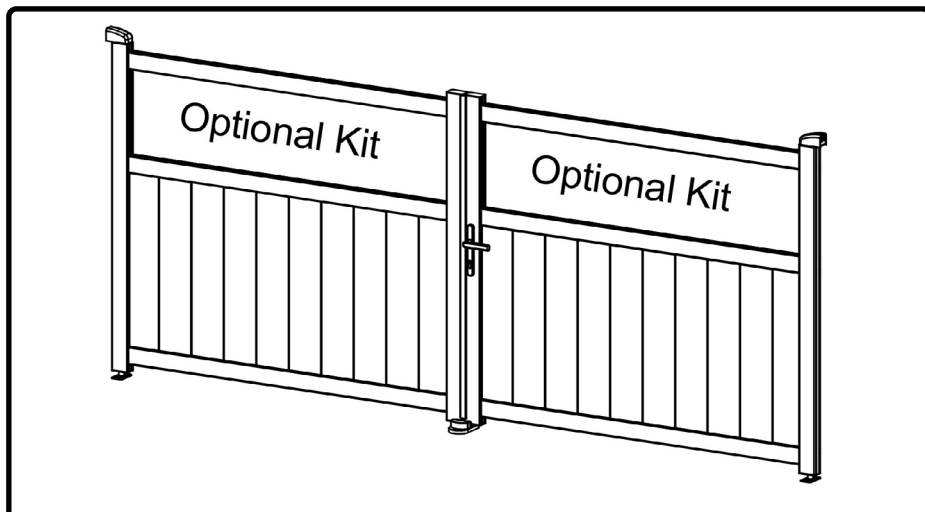

COM-001126 [x1]

COM-001131 [x1]

COM-001127 [x1]



EN FR DE ES PT IT NL PL FI SE DK

RO SI SK HU CZ HR GR LT LV



INSTRUCTION MANUAL / NOTICE DE MONTAGE / MONTAGEANLEITUNG / MANUAL DE MONTAJE / MANUAL DE MONTAGEM / MANUALE DI MONTAGGIO /  
MONTAGEHANDLEIDING / INSTRUKCJA MONTAŻU / KÄYTTÖOHJEET / BRUKSANVISNING / BRUGSANVISNING / INSTRUCȚIUNI DE ASAMBLARE /  
NAVODILA ZA SESTAVLJANJE / NÁVOD NA MONTÁŽ / ÖSSZESZERELÉSI ÚTMUTATÓ / NÁVOD K MONTÁŽI / UPUTE ZA INSTALACIJU /  
ΟΔΗΓΙΕΣ ΣΥΝΑΡΜΟΛΟΓΗΣΗΣ / SURINKIMO INSTRUKCIJOS / MONTĀŽAS INSTRUKCIJAS

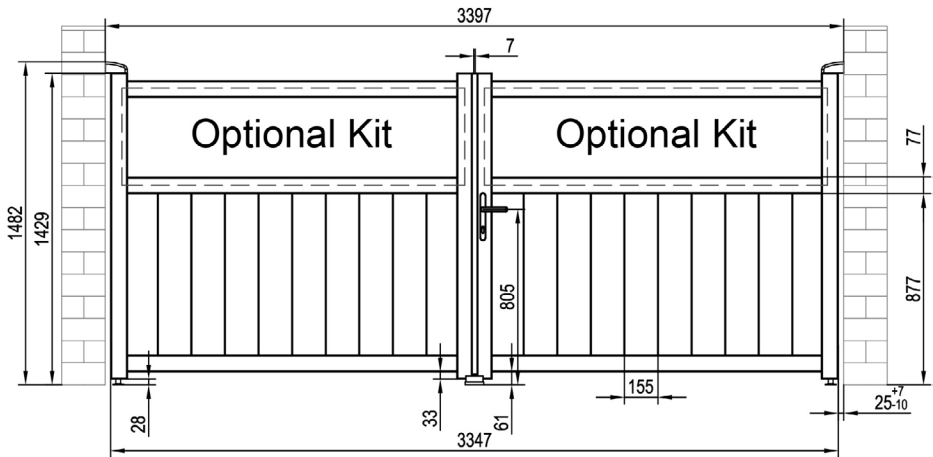





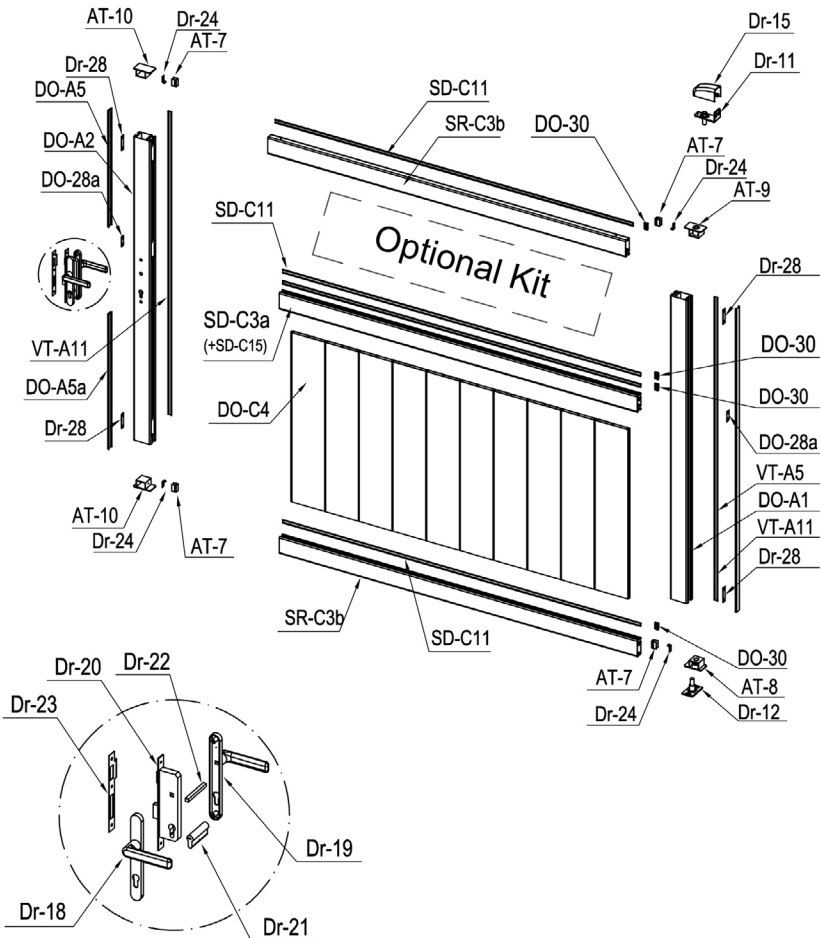
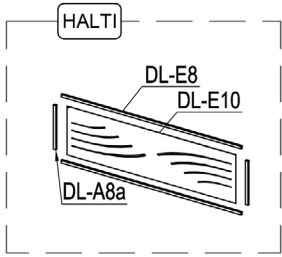
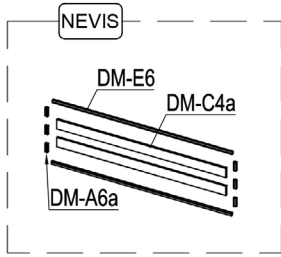
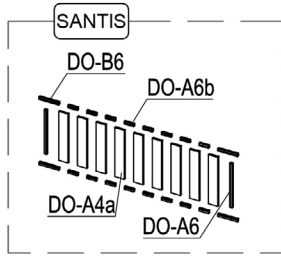













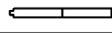





















# CASANOVO

















## PARTS LIST

IMAGE	NO.	L.(mm)	QTY	IMAGE	NO.	L.(mm)	QTY
	DO-A1	1395	1		Dr-20		1
	DO-A1a	1395	1		Dr-21		1
	DO-A1b	1395	1		Dr-22		1
	DO-A2	1395	1		Dr-23		1
	SR-C3b	1647	4		Dr-25		1
	SD-C3a (+SD-C15)	1647	2		Dr-25a		2
	DO-C4	779	20		Dr-26		3
	VT-A5	1395	2		Dr-27		2
	DO-A5	532.5	1		Dr-24		8
	DO-A5a	622	1		Dr-28		8
	Dr-A5c	19.5	1		DO-28a		4
	VT-A11	1395	4		DO-J30	ST4x10	8
	SD-C11	1647	8		DO-J31	ST5.5x38	24
	AT-7	29.5	8		DO-J32	ST4.8x38	12
	DO-A7	1375	1		DO-J33	M8x60	12
	AT-8		2		DO-J34	ST6x40	3
	AT-9		2		DO-J35	ST4.2x13	48
	AT-10		4		DO-J36	Ø6	3
	Dr-11		2				
	Dr-12		2				
	Dr-13		1				
	Dr-14		1				
	Dr-15		2				
	Dr-16		1				
	Dr-17		2				
	Dr-31		4				
	DO-30		8				
	Dr-18		1				
	Dr-19		1				

## PARTS LIST (Optional Kit)

<p>Com-001131</p> 	IMAGE	NO.	L.(mm)	QTY
		DO-A4a	406	18
		DO-A6	364	4
		DO-B6	163	8
		DO-A6b	77.5	32
	DO-35		36	

<p>Com-001132</p> 	IMAGE	NO.	L.(mm)	QTY
		LR-C4a	1555	4
		DM-E6	1645	4
		DM-A6a	69	12
	DO-32		8	

<p>Com-001133</p> 	IMAGE	NO.	L.(mm)	QTY
		DL-E8	1645	4
		DL-A8a	364	4
		DL-E10	1552	2
		DO-32		8
	DO-35		16	

# CASANOVO

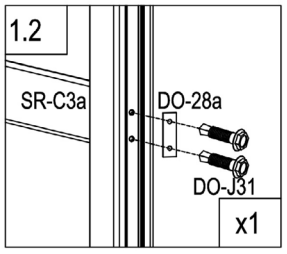
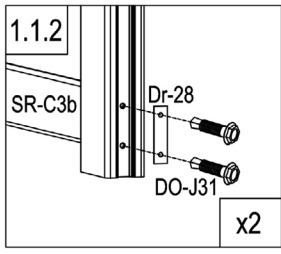
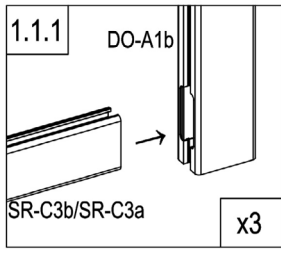
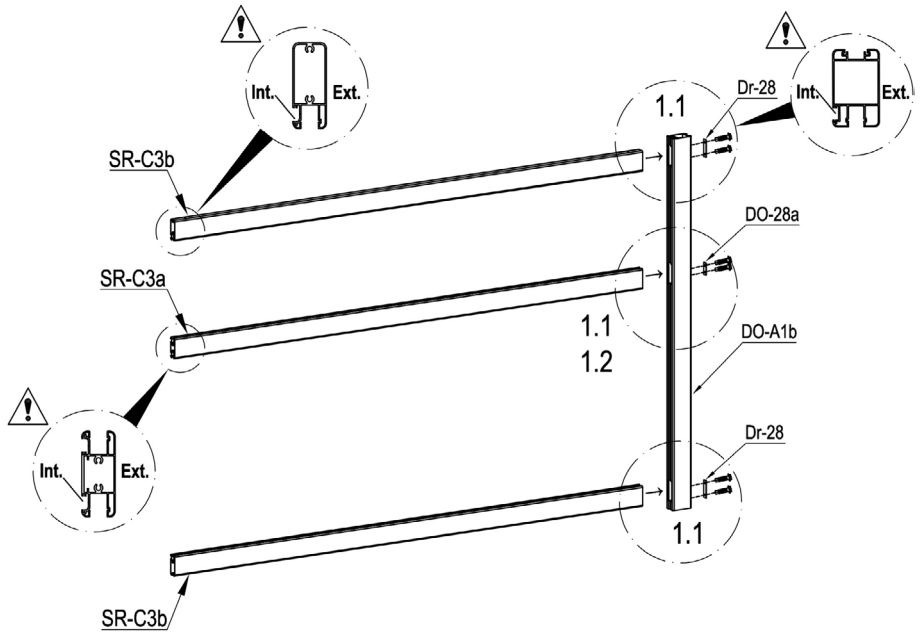

	DO-A1b	1
	SR-C3b	2
	SR-C3a	1

	Dr-28	2
	DO-28a	1
	DO-J31	6

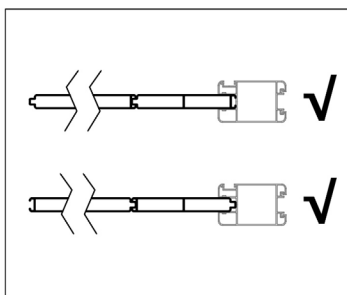
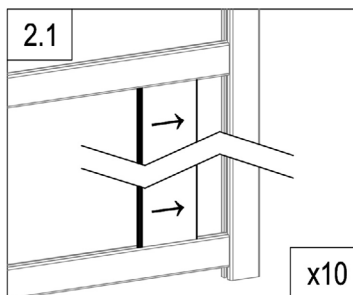
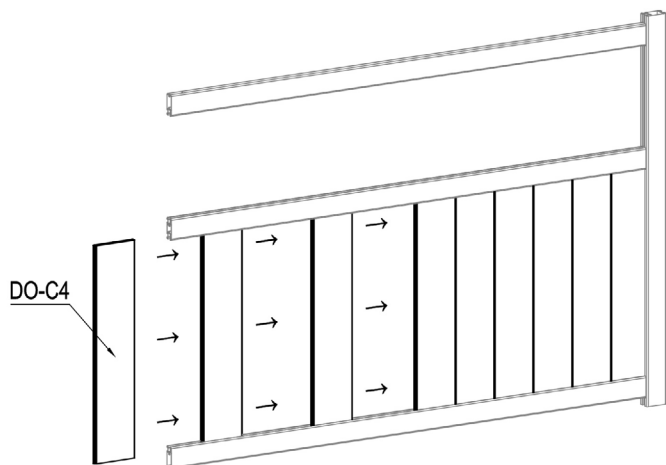

	DO-C4	10
--	-------	----

SD-C15

3.1

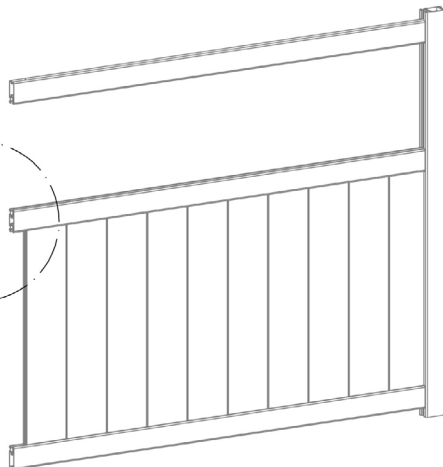
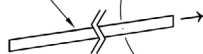

- EN: reinforced slat for automation
- FR : lame renforcée pour l'automatisation
- DE : verstärkte Lamelle für die Automatisierung
- ES: Lámina reforzada para la automatización
- PT: ripa reforçada para automatização
- IT: lamella rinforzata per l'automazione
- NL: versterkte lat voor automatisering
- PL: wzmocniona listwa do automatyzacji

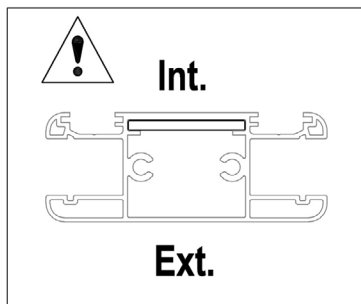
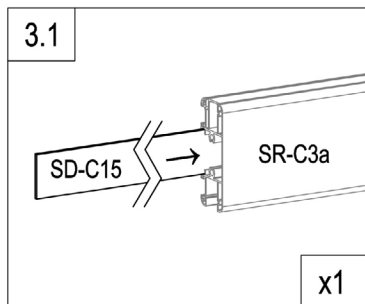

	SD-C15	1
---	--------	---

Optional Kit →

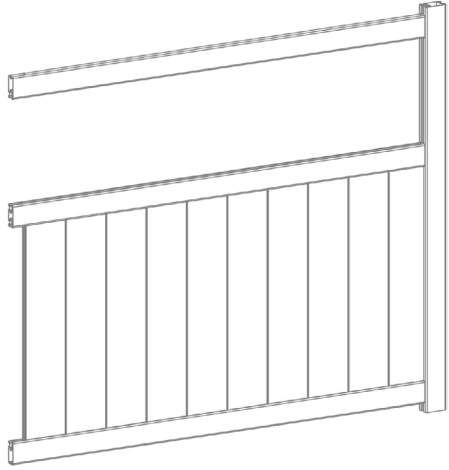

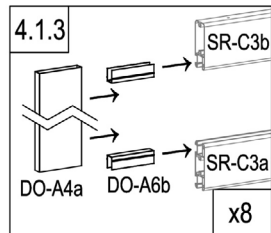
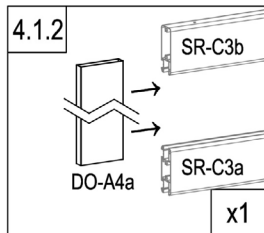
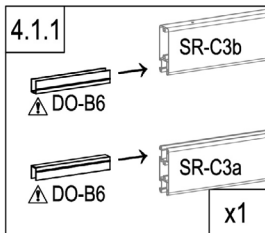
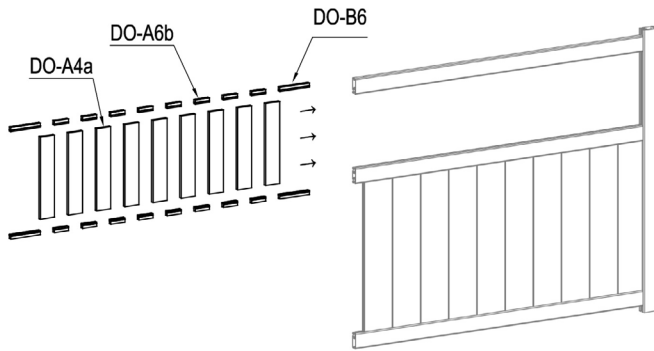

	DO-A4a	406mm	9
	DO-B6	163mm	4
	DO-A6b	77.5mm	16

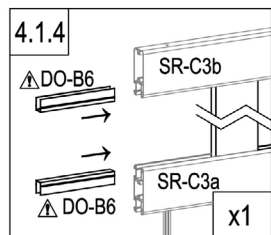

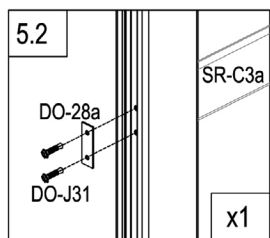
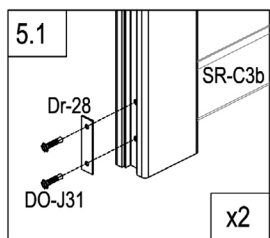
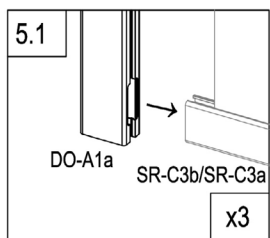
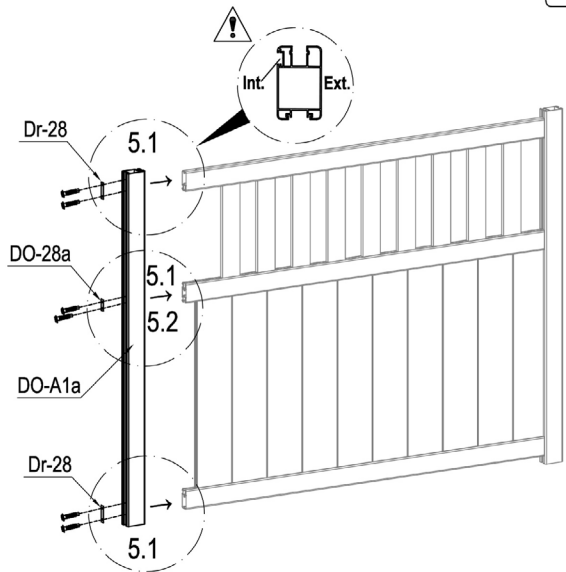

	DO-A1a	1
	Dr-28	2
	DO-28a	1
	DO-J31	6



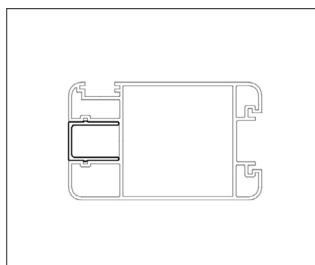
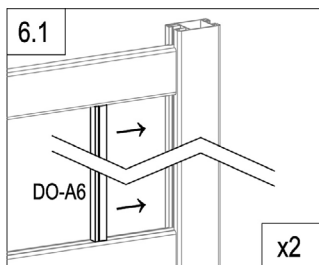
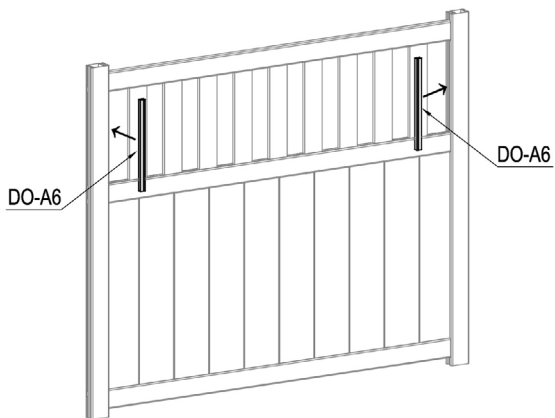

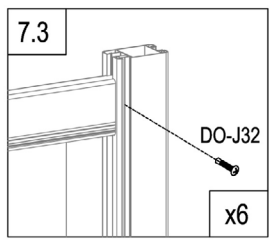
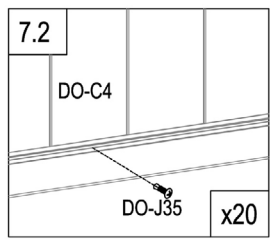
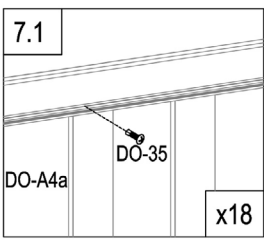
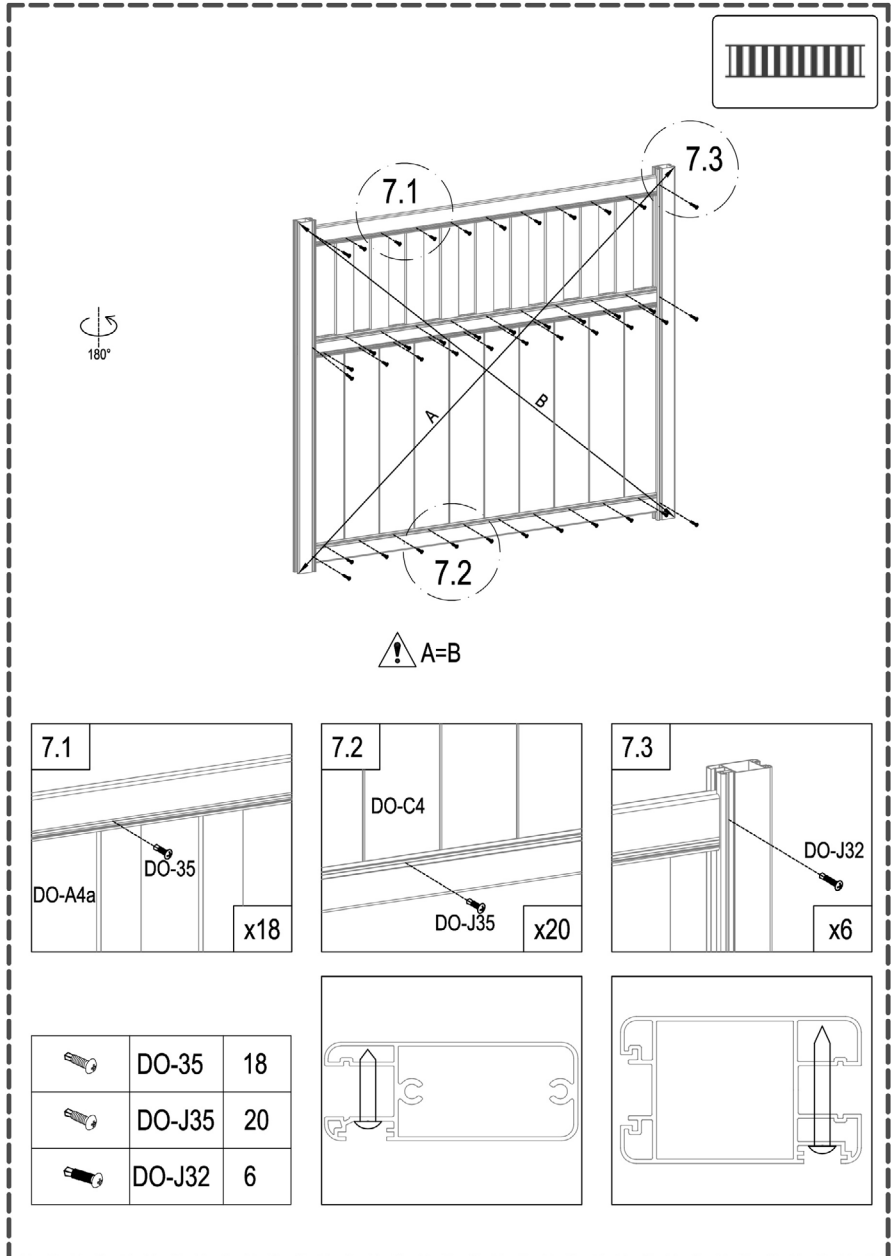

	DO-A6	2
--	-------	---

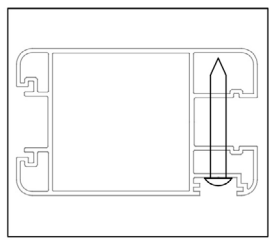
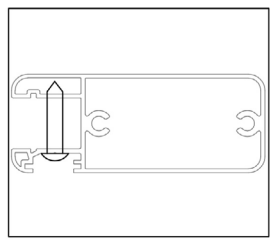

	DO-35	18
	DO-J35	20
	DO-J32	6

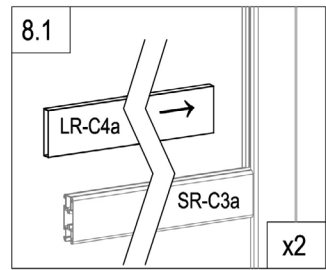
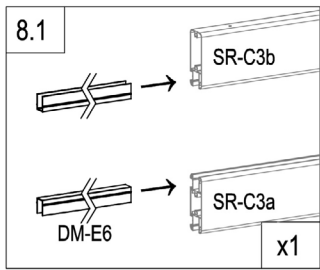
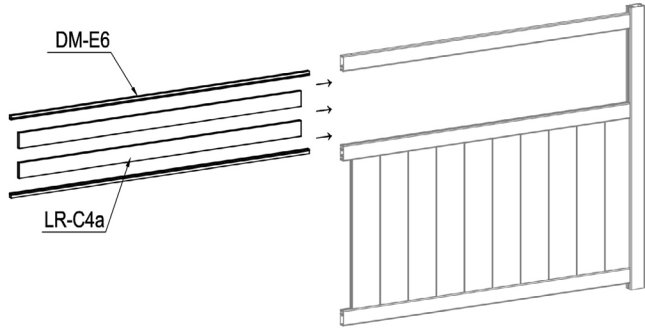



	LR-C4a	2
	DM-E6	2

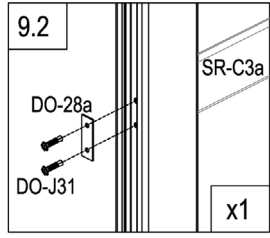
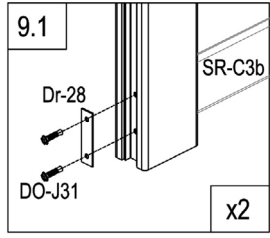
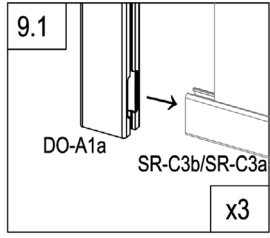
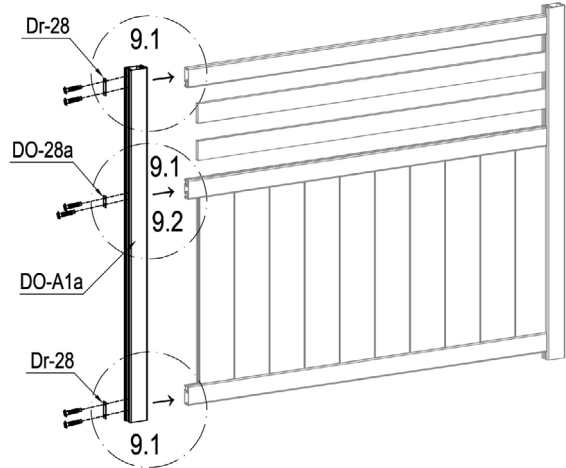
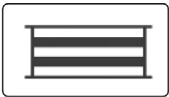

	DO-A1a	1
	Dr-28	2
	DO-28a	1
	DO-J31	6

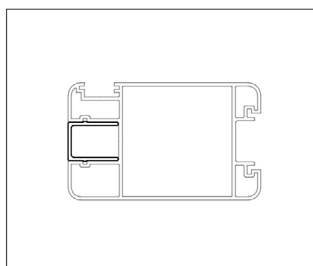
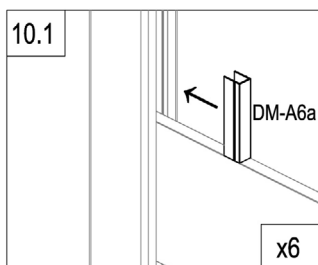
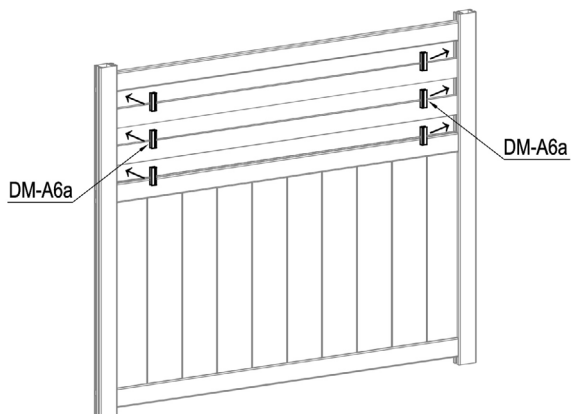

	DM-A6a	6
---	--------	---

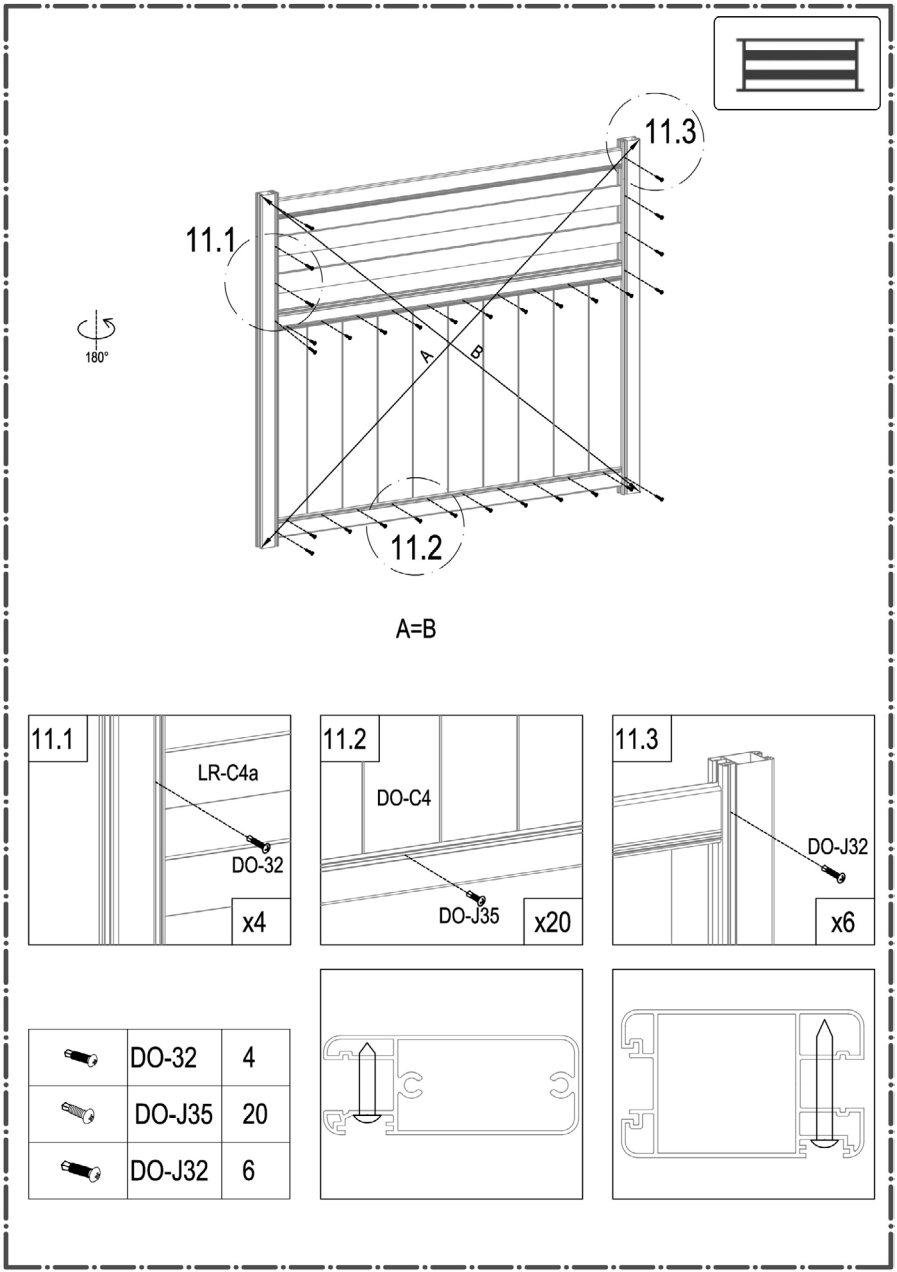

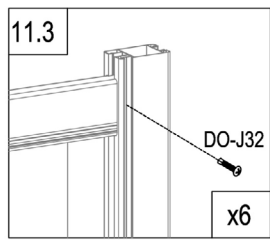
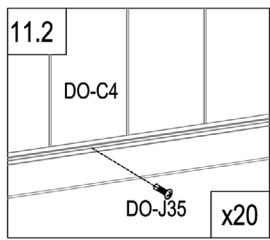
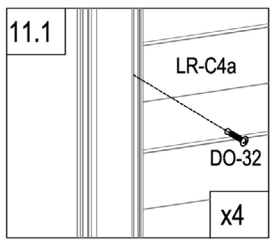

A=B

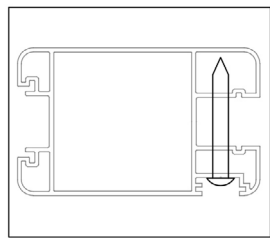
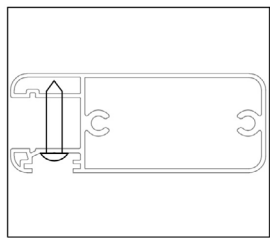

	DO-32	4
	DO-J35	20
	DO-J32	6

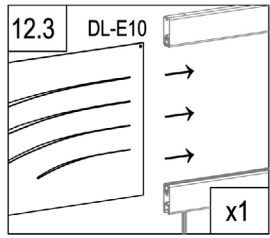
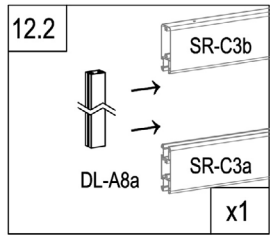
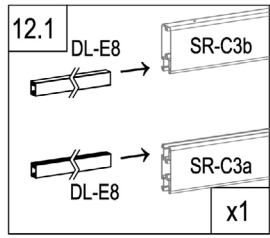
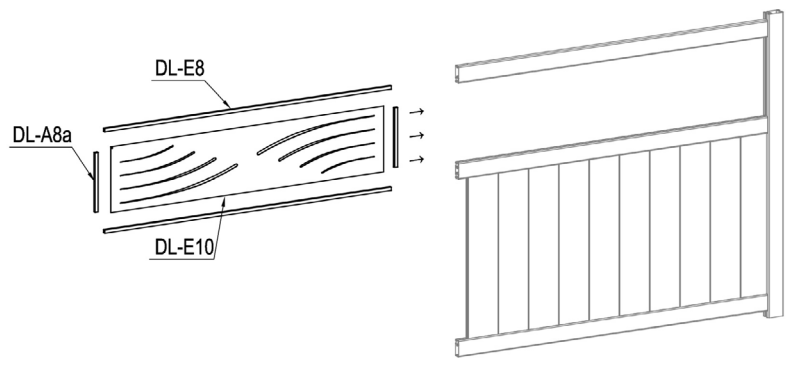



	DL-E10	1
	DL-E8	2
	DL-A8a	2

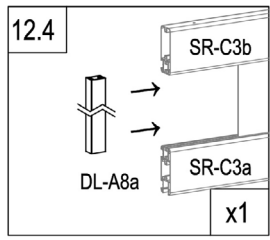

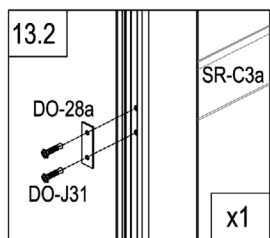
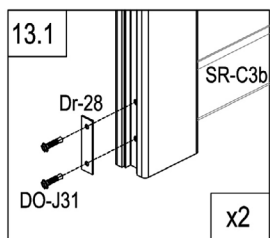
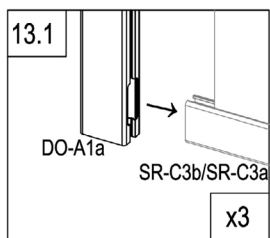
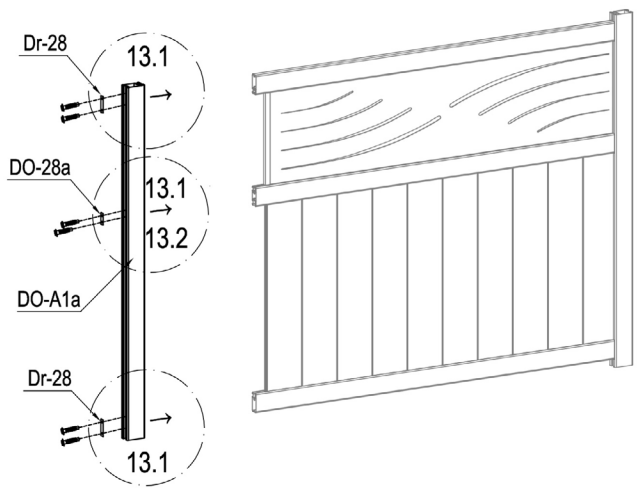

	DO-A1a	1
	Dr-28	2
	DO-28a	1
	DO-J31	6



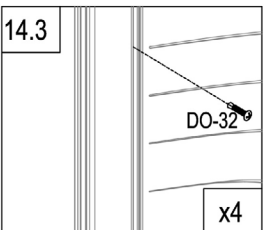
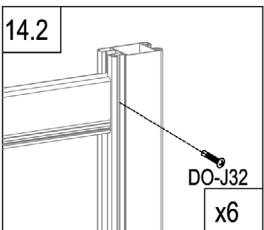
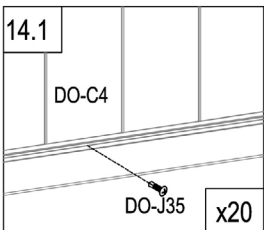
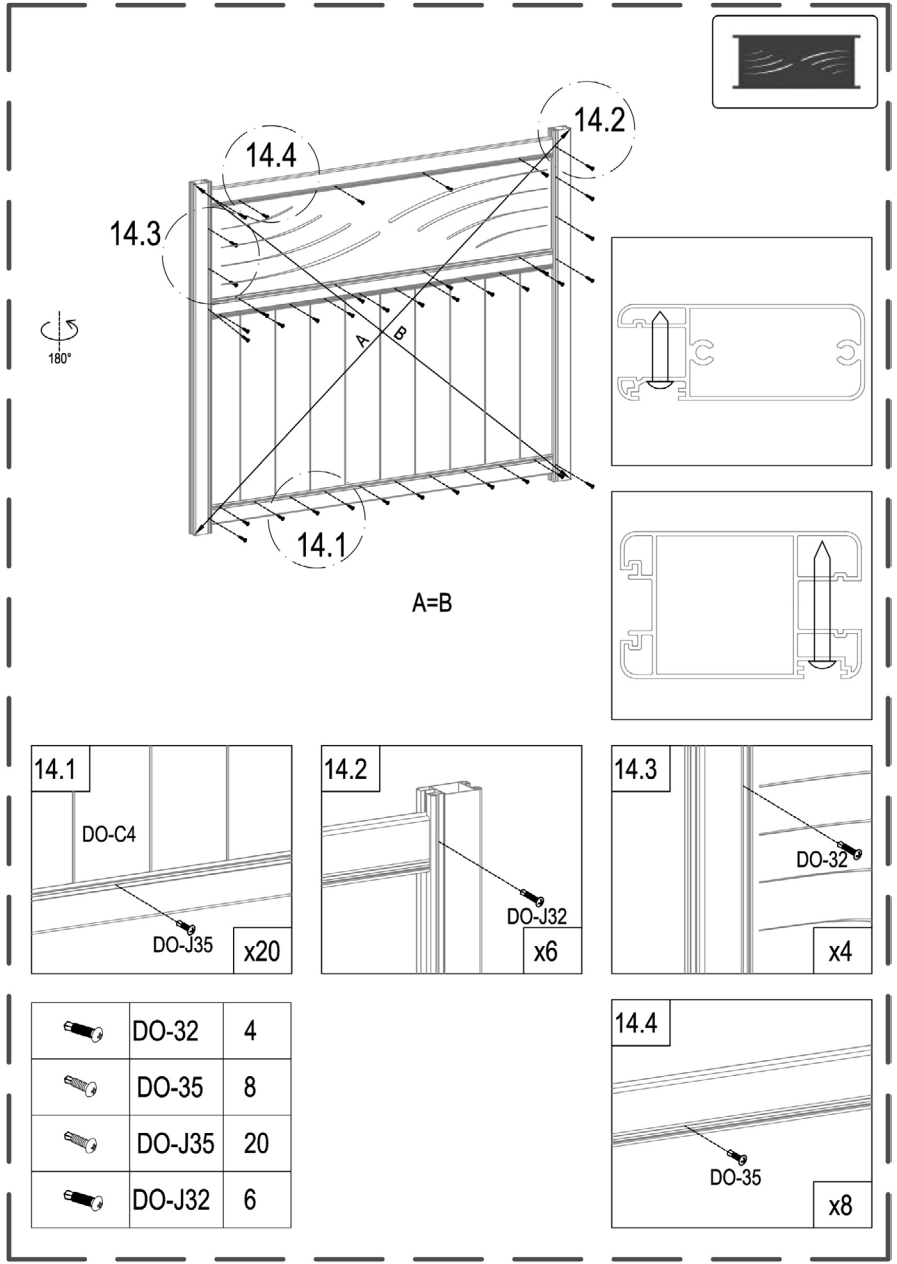

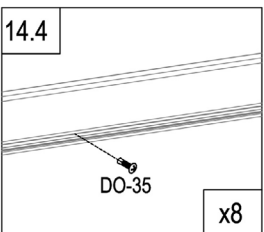

	DO-32	4
	DO-35	8
	DO-J35	20
	DO-J32	6

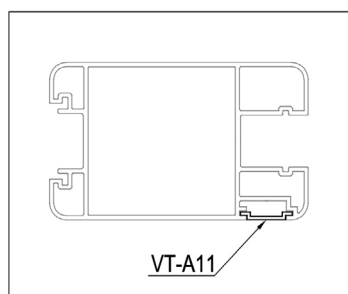
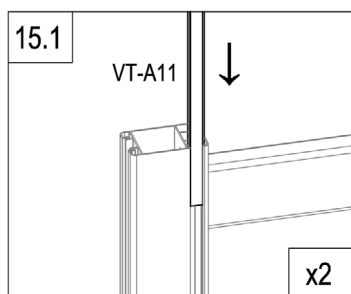
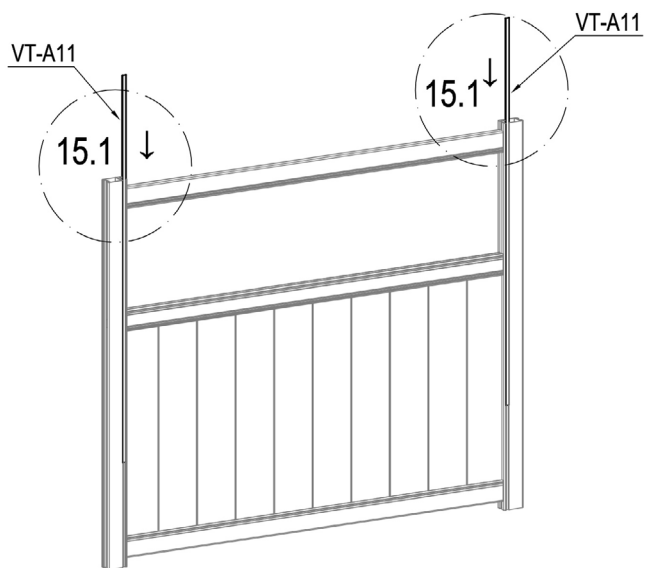



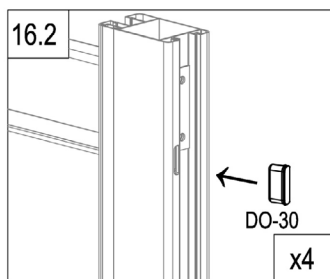
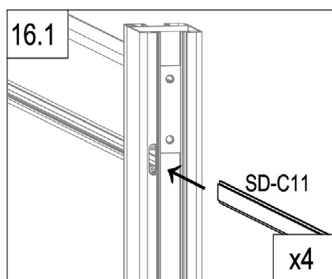
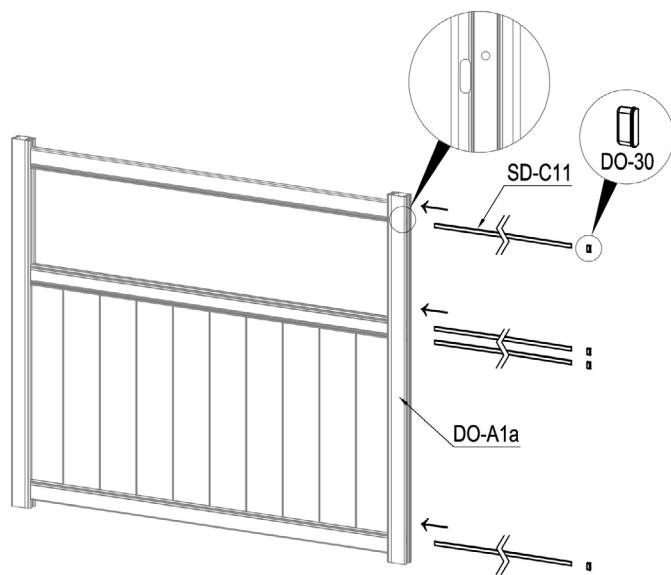

	VT-A11	2
---	--------	---

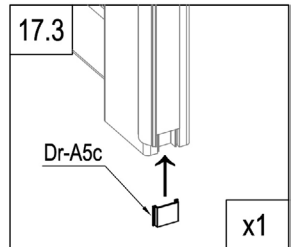
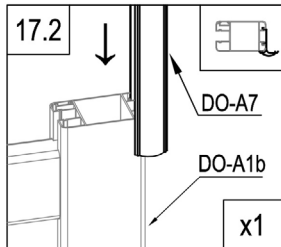
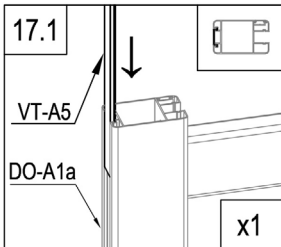
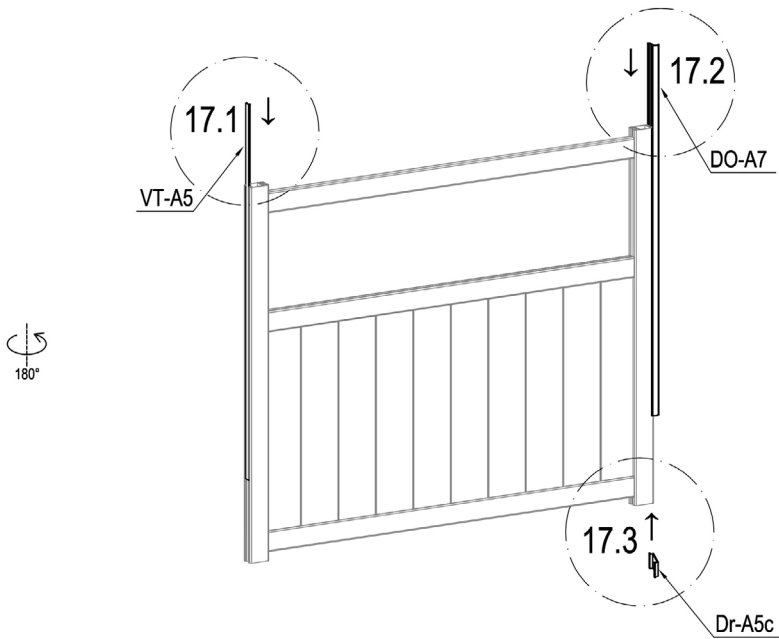

	SD-C11	4
	DO-30	4



	VT-A5	1
	Dr-A5c	1
	DO-A7	1

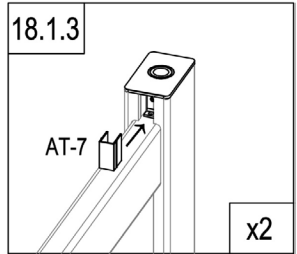
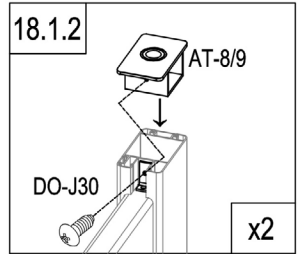
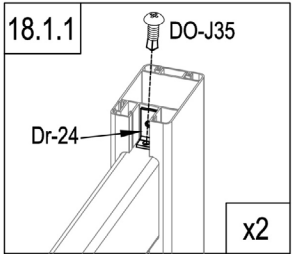
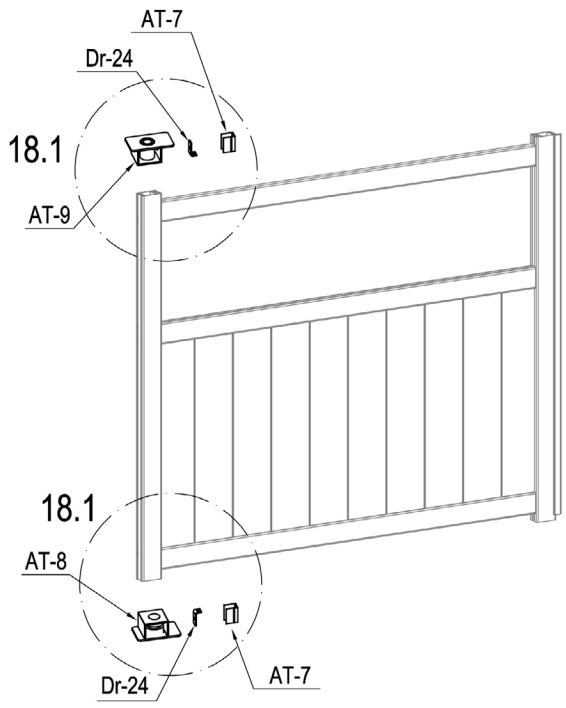

	AT-8	1
	AT-9	1
	Dr-24	2

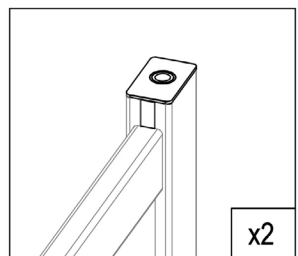

	AT-7	2
	DO-J30	2
	DO-J35	2

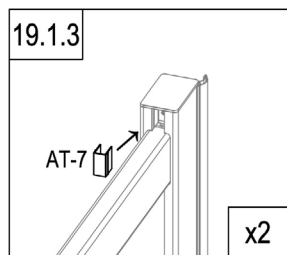
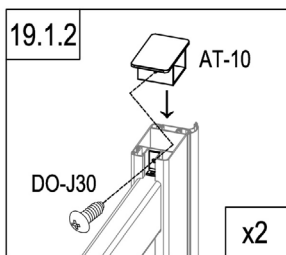
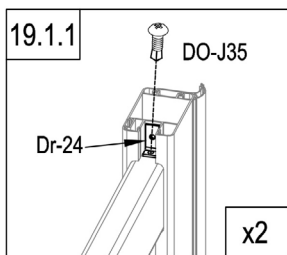
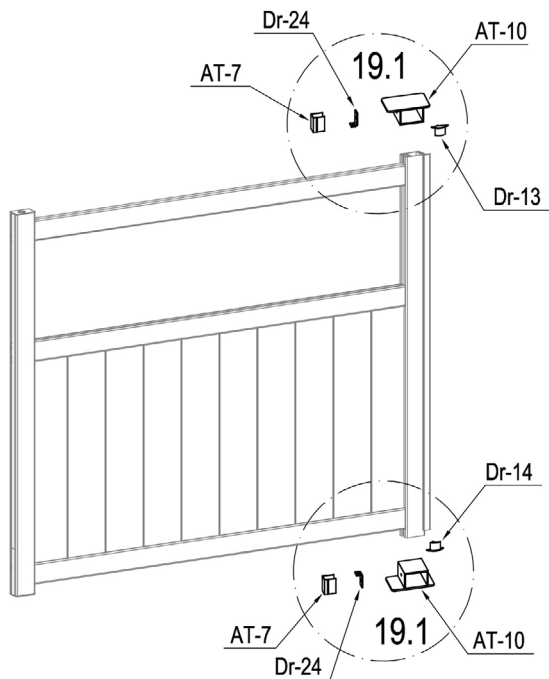

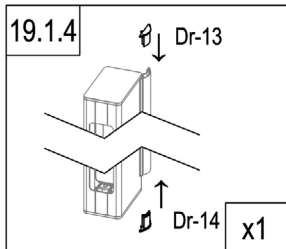

	AT-10	2
	Dr-24	2
	AT-7	2
	Dr-13	1



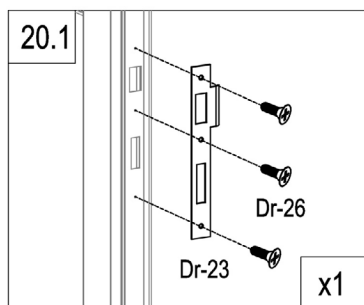
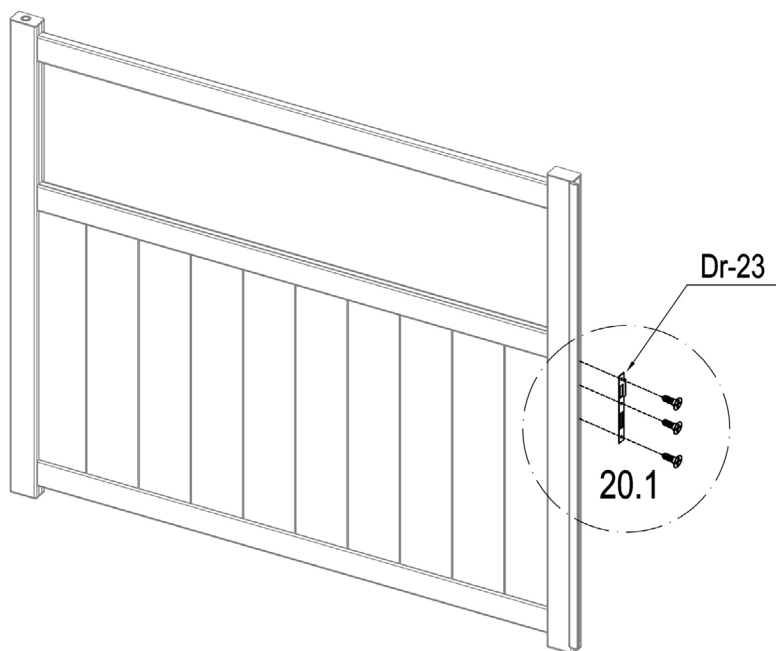



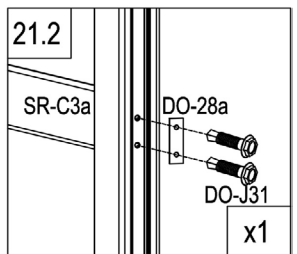
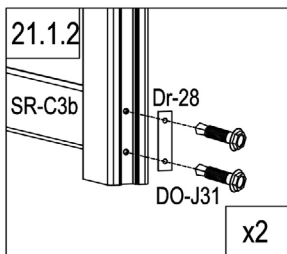
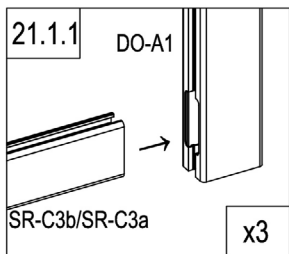
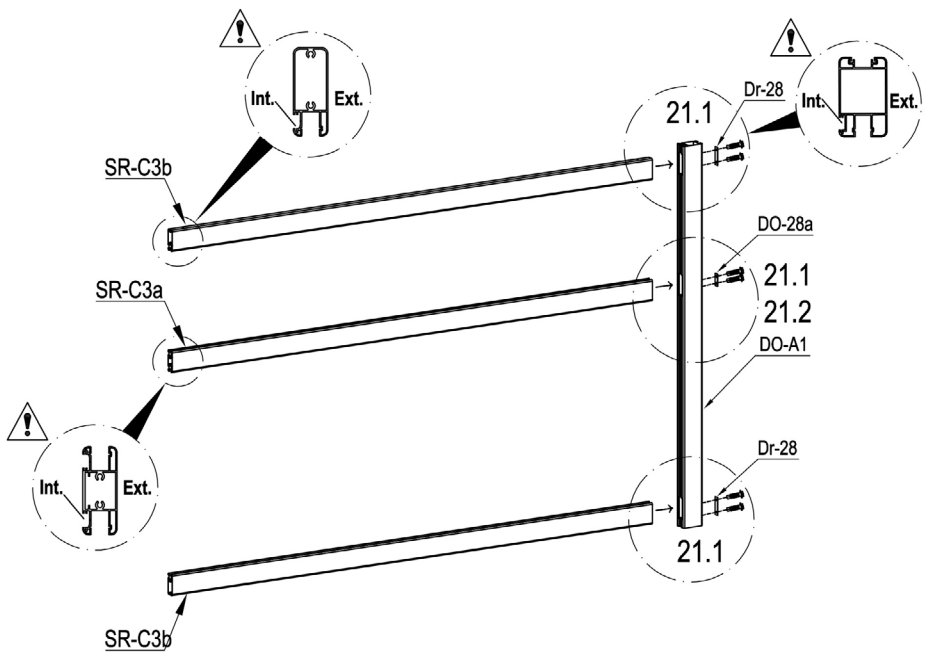

	Dr-14	1
	DO-J30	2
	DO-J35	2



	Dr-23	1
	Dr-26	3



	DO-A1	1
	SR-C3b	2
	SR-C3a	1

	Dr-28	2
	DO-28a	1
	DO-J31	6



# CASANOVO

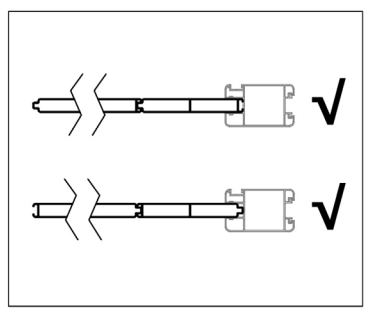
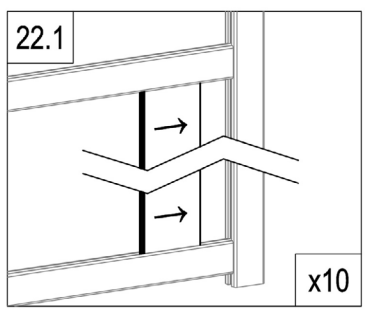
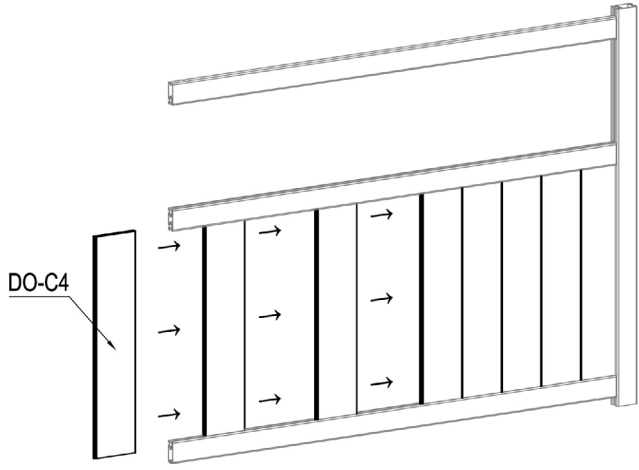

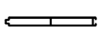
	DO-C4	10
---	-------	----

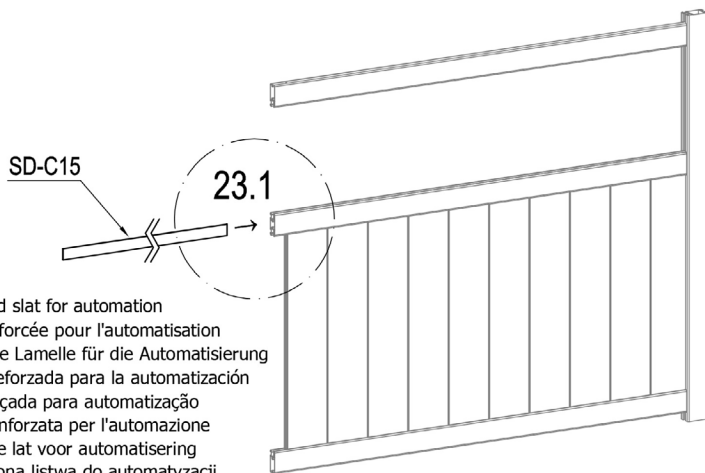

- EN: reinforced slat for automation
- FR : lame renforcée pour l'automatisation
- DE : verstärkte Lamelle für die Automatisierung
- ES: Lámina reforzada para la automatización
- PT: ripa reforçada para automatização
- IT: lamella rinforzata per l'automazione
- NL: versterkte lat voor automatisering
- PL: wzmocniona listwa do automatyzacji

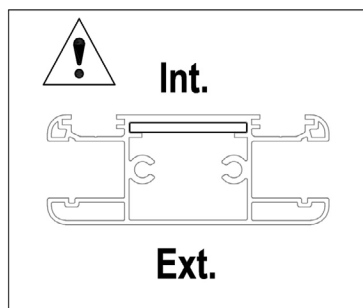
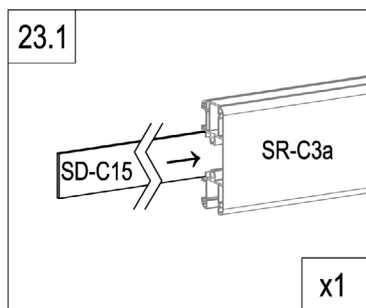

	SD-C15	1
---	--------	---

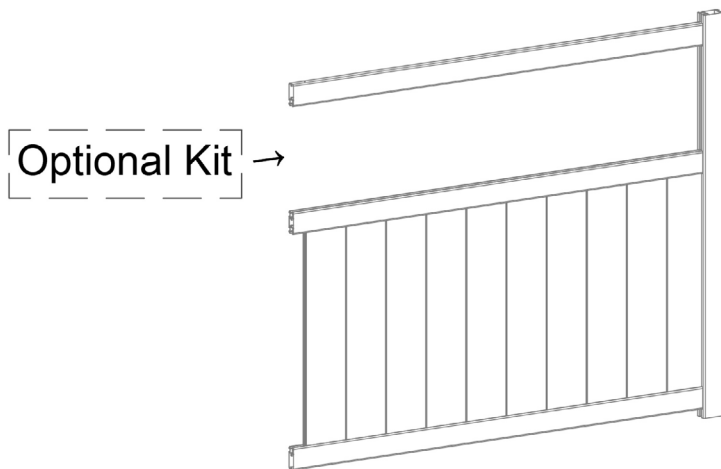

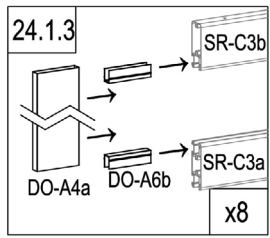
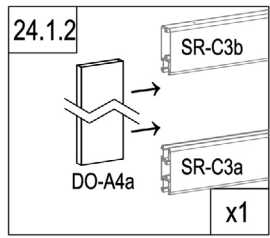
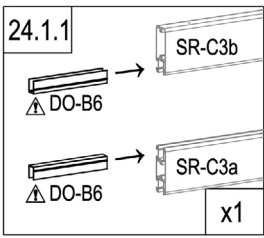
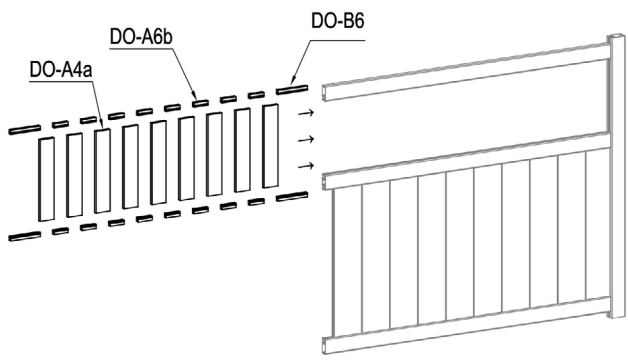

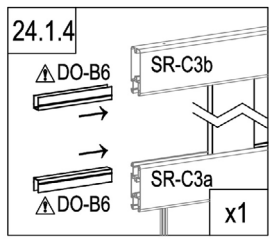

	DO-A4a	406mm	9
	DO-B6	163mm	4
	DO-A6b	77.5mm	16

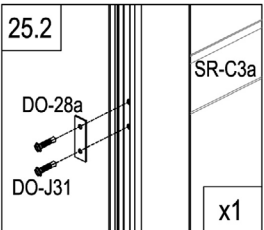
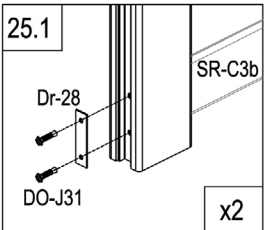
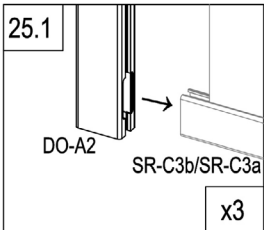
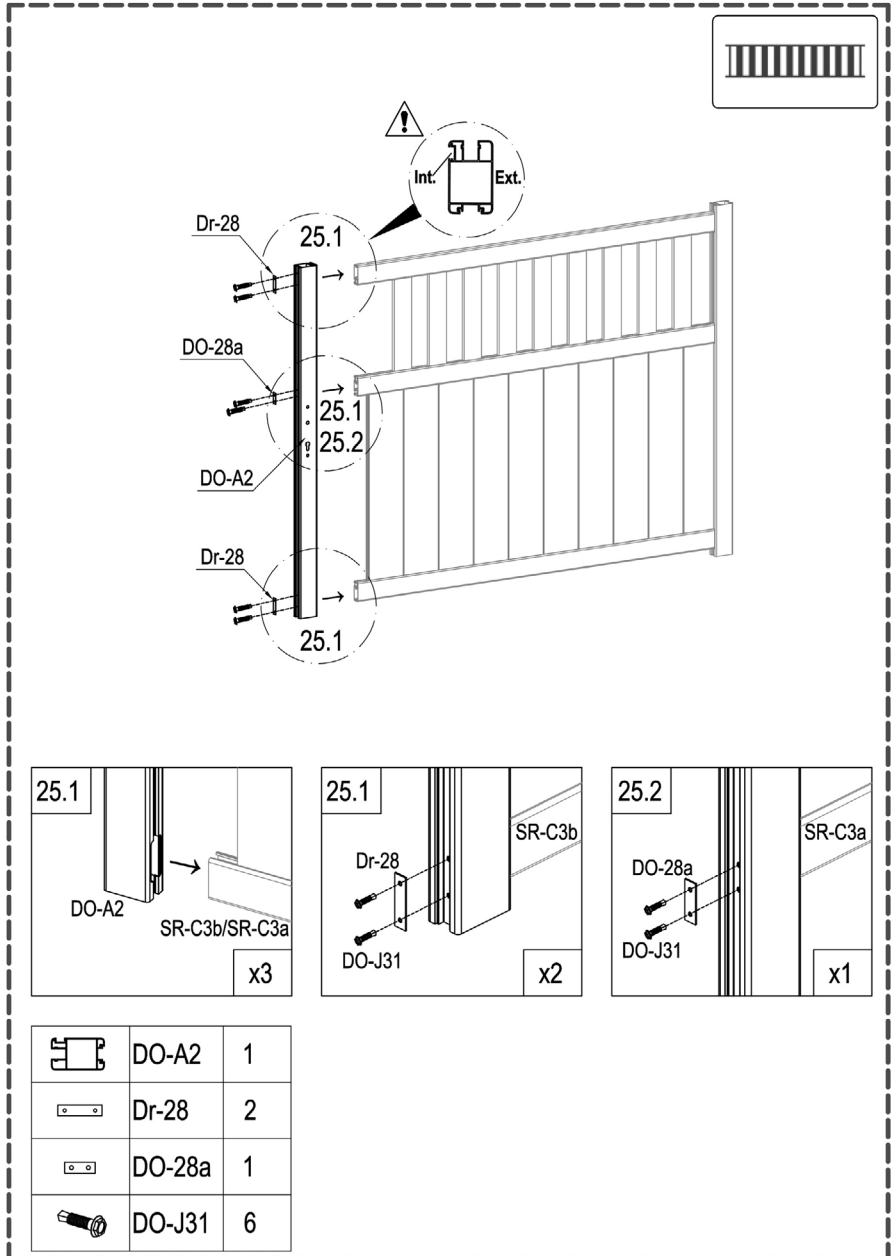

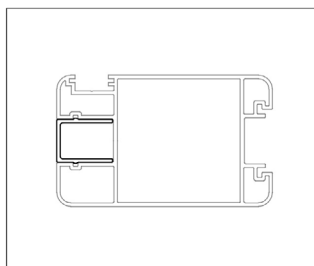
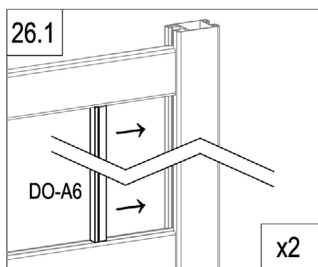
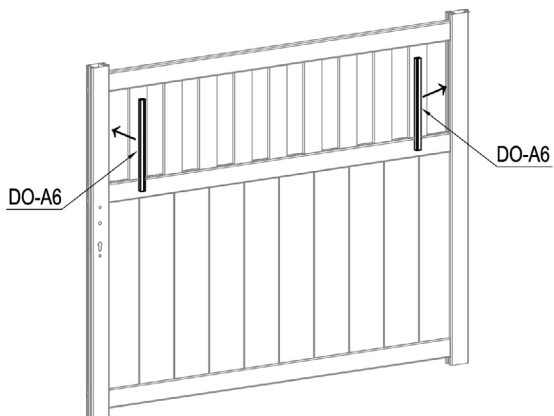

	DO-A2	1
	Dr-28	2
	DO-28a	1
	DO-J31	6



	DO-A6	2
---	-------	---

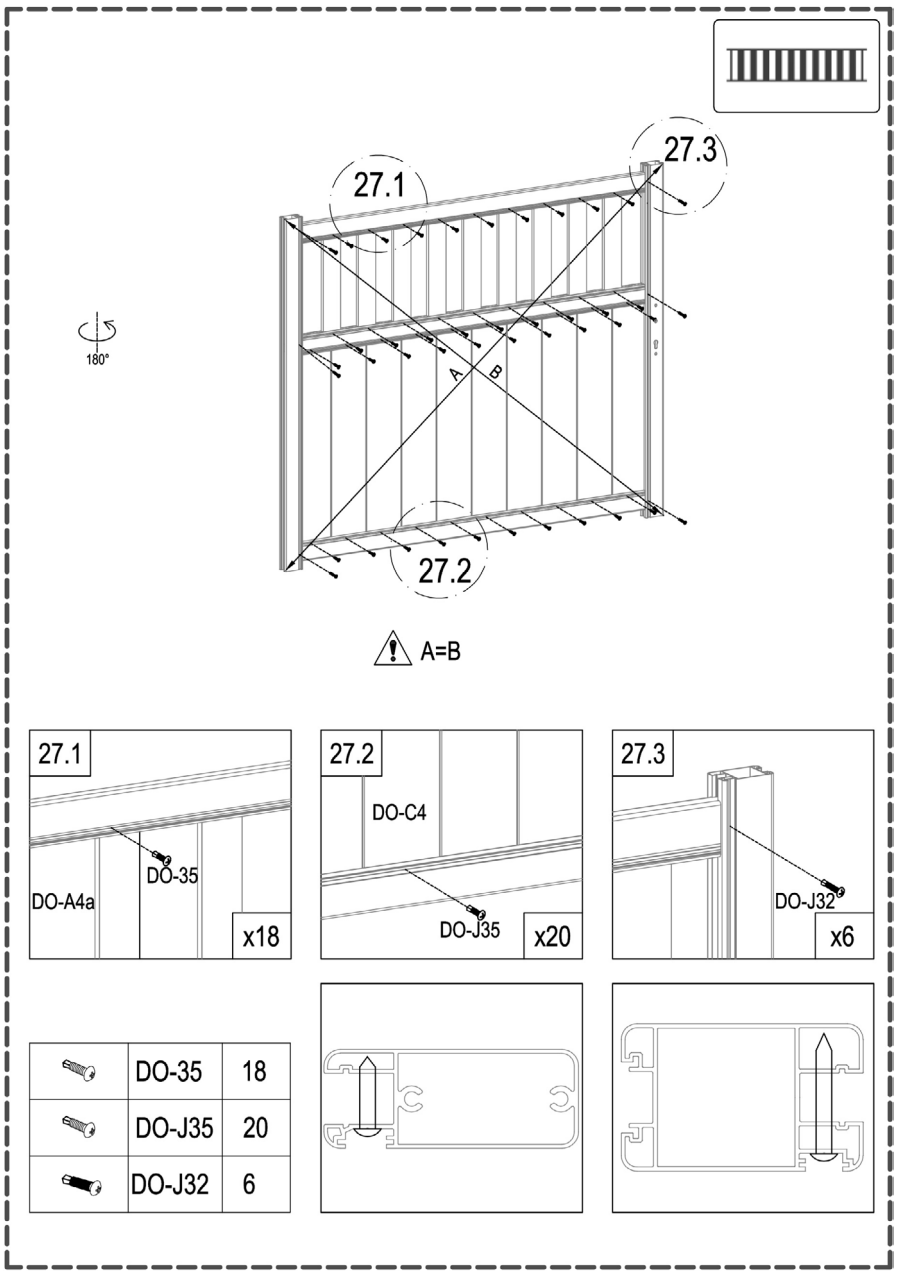

180°

! A=B

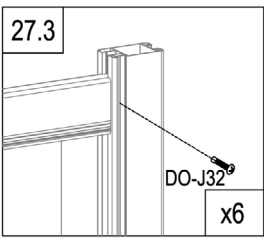
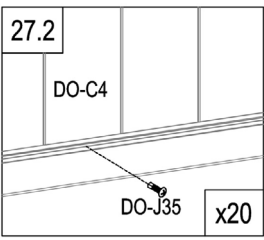
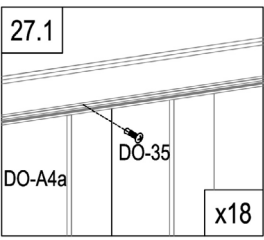

	DO-35	18
	DO-J35	20
	DO-J32	6

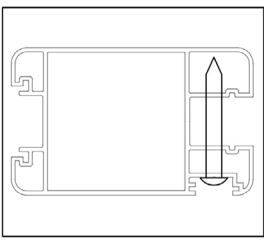
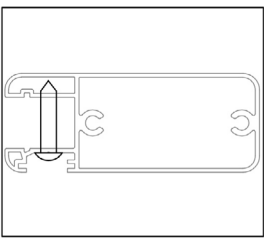

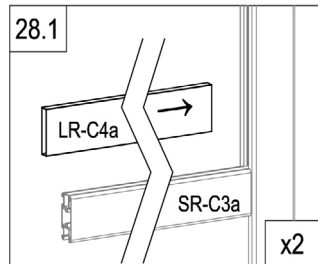
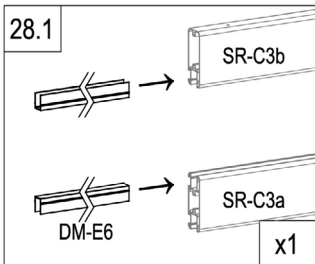
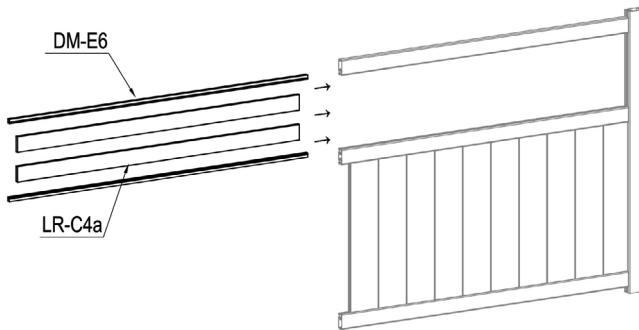

	LR-C4a	2
	DM-E6	2



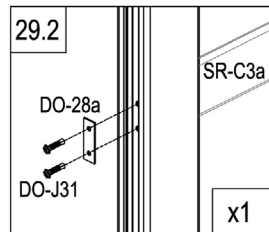
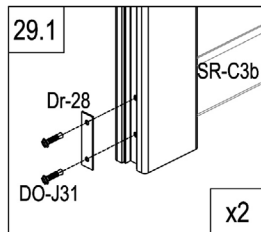
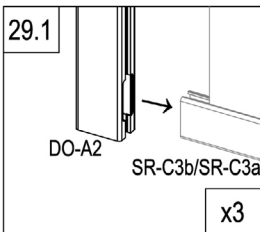
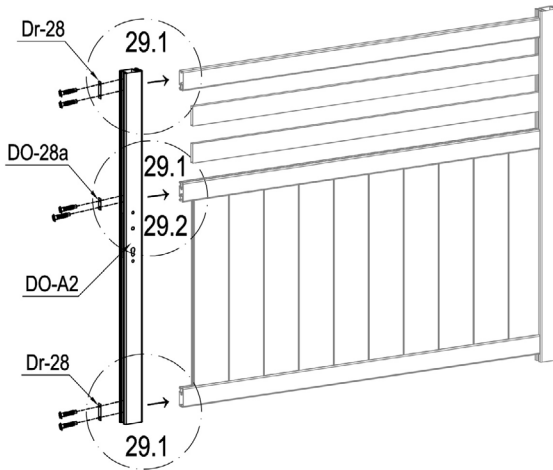

	DO-A2	1
	Dr-28	2
	DO-28a	1
	DO-J31	6

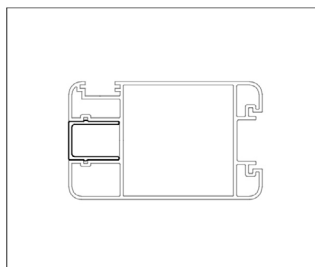
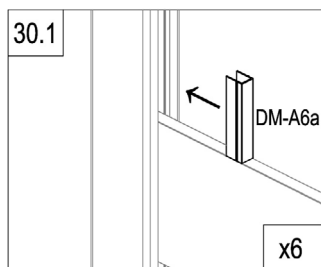
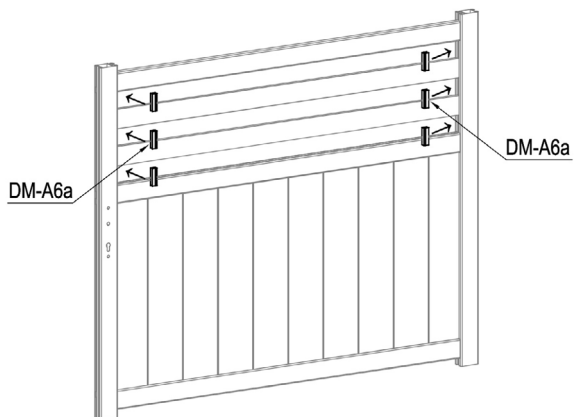

	DM-A6a	6
--	--------	---

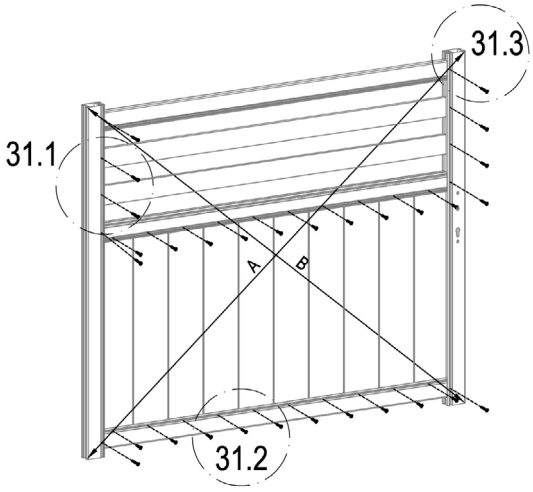
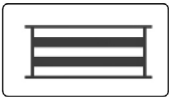

A=B

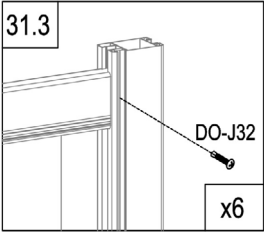
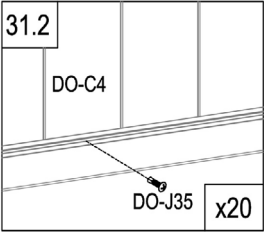
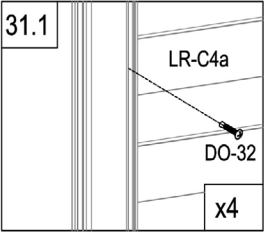

	DO-32	4
	DO-J35	20
	DO-J32	6

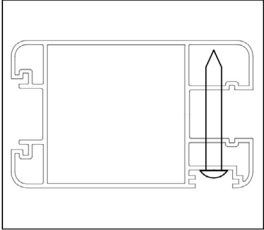
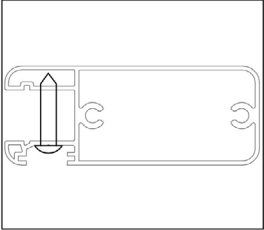

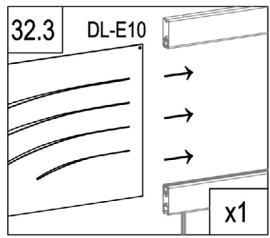
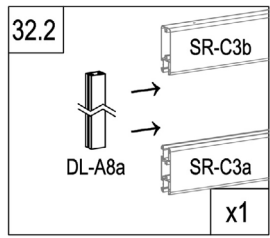
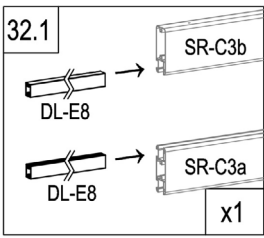
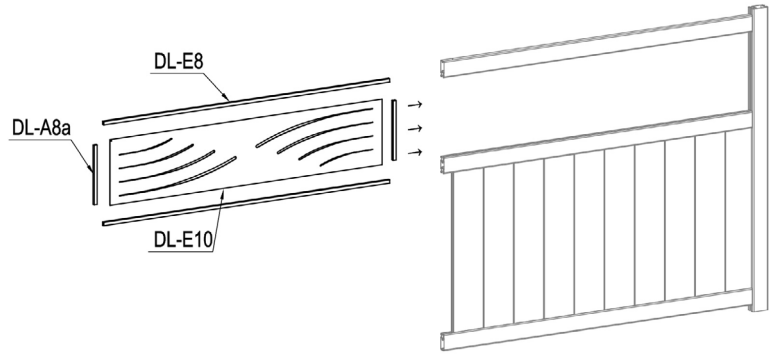

	DL-E10	1
	DL-E8	2
	DL-A8a	2

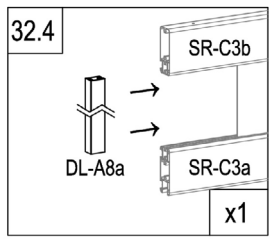

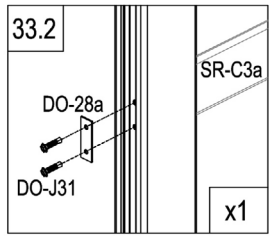
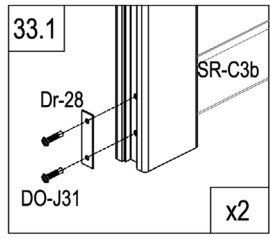
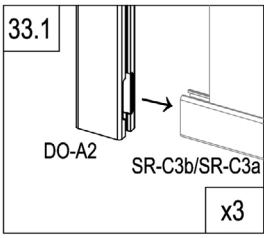
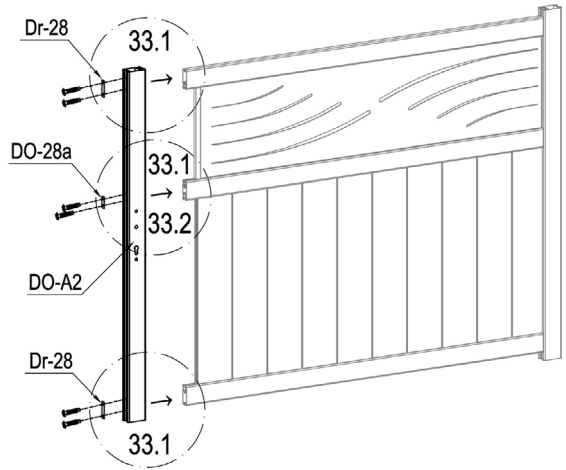

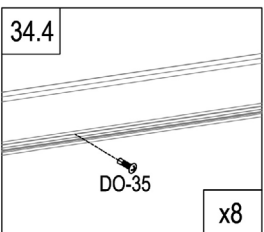
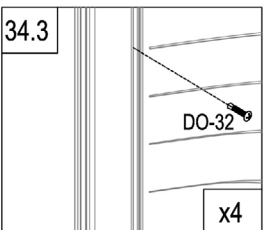
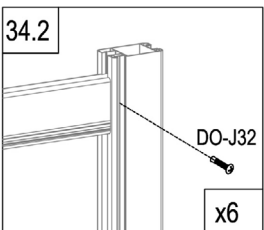
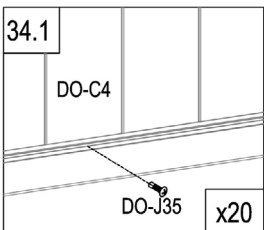
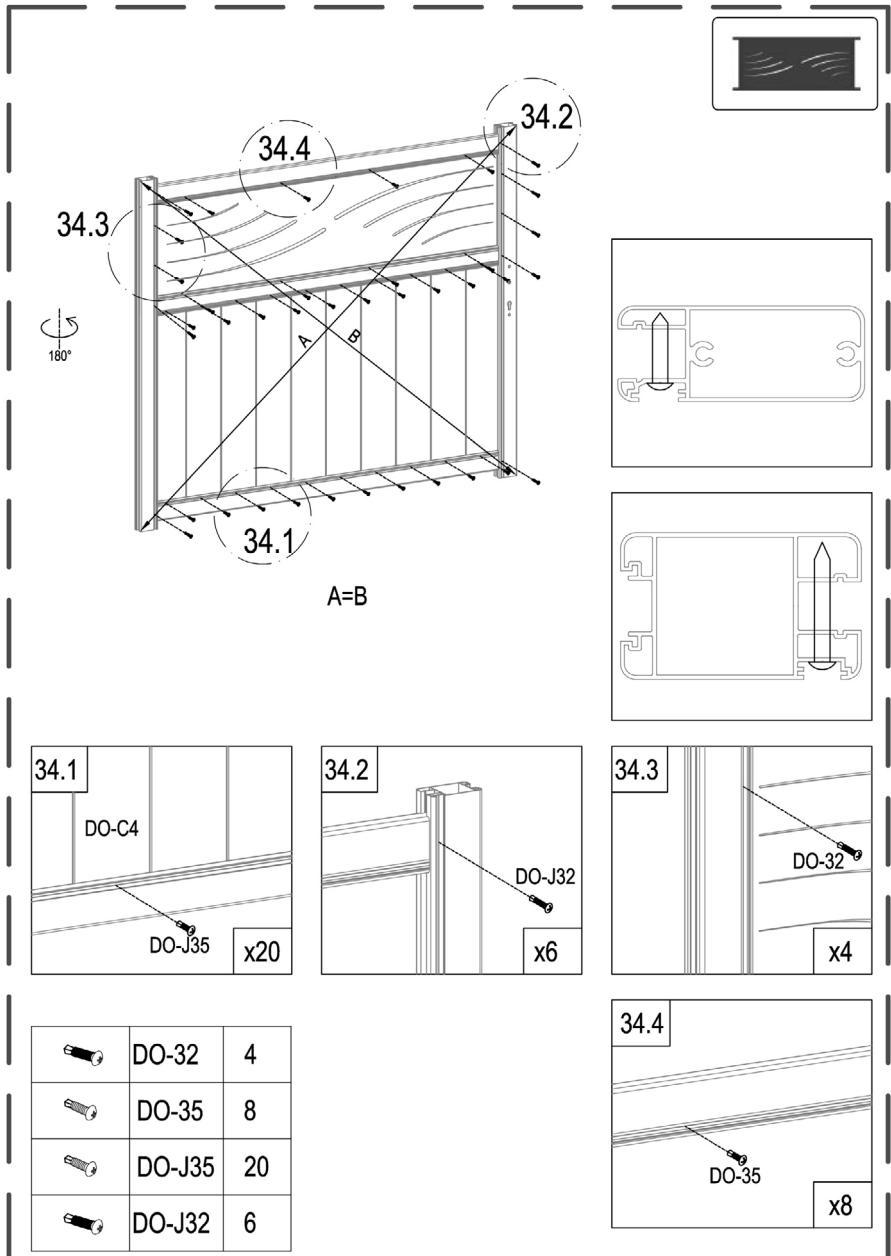

	DO-A2	1
	Dr-28	2
	DO-28a	1
	DO-J31	6



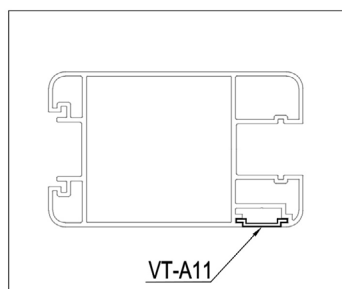
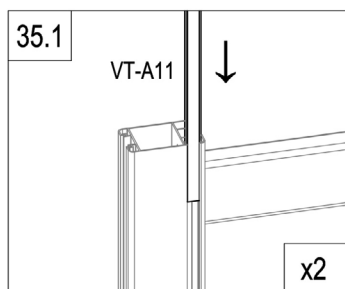
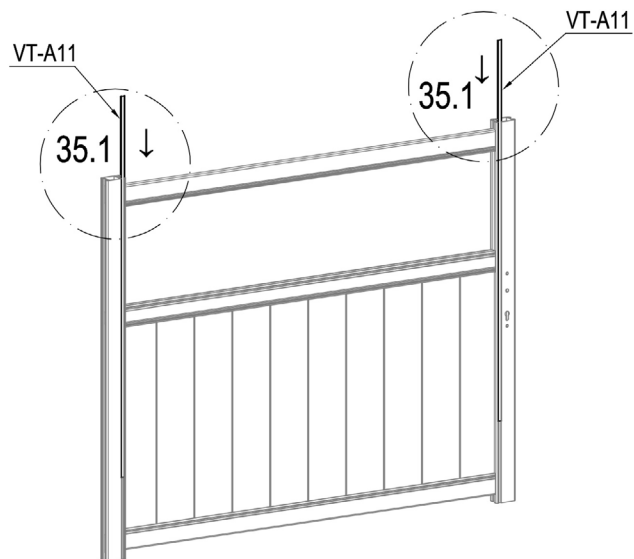

	DO-32	4
	DO-35	8
	DO-J35	20
	DO-J32	6

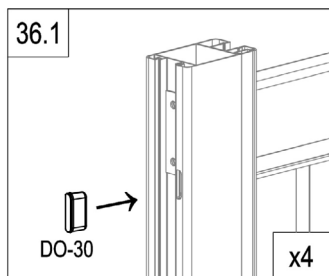
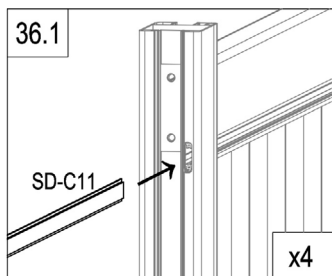
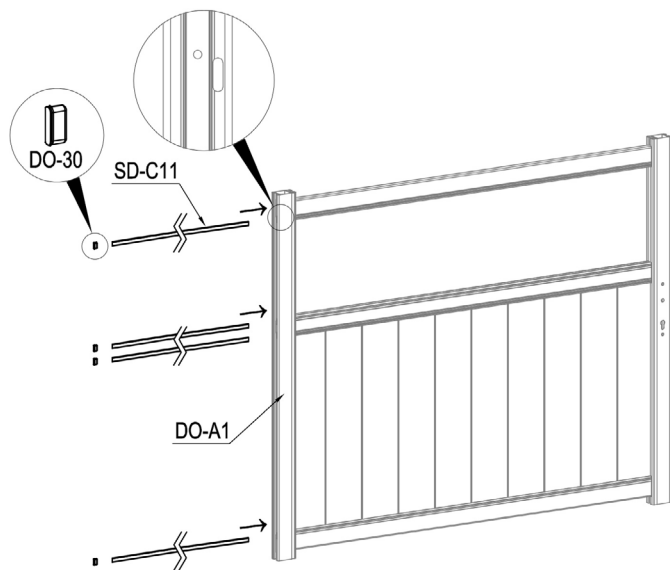

	VT-A11	2
---	--------	---



	SD-C11	4
	DO-30	4



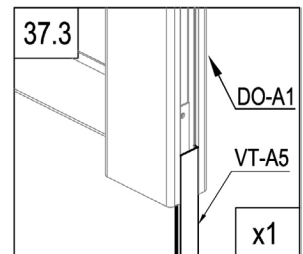
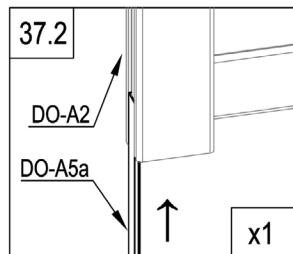
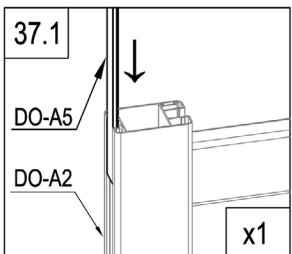
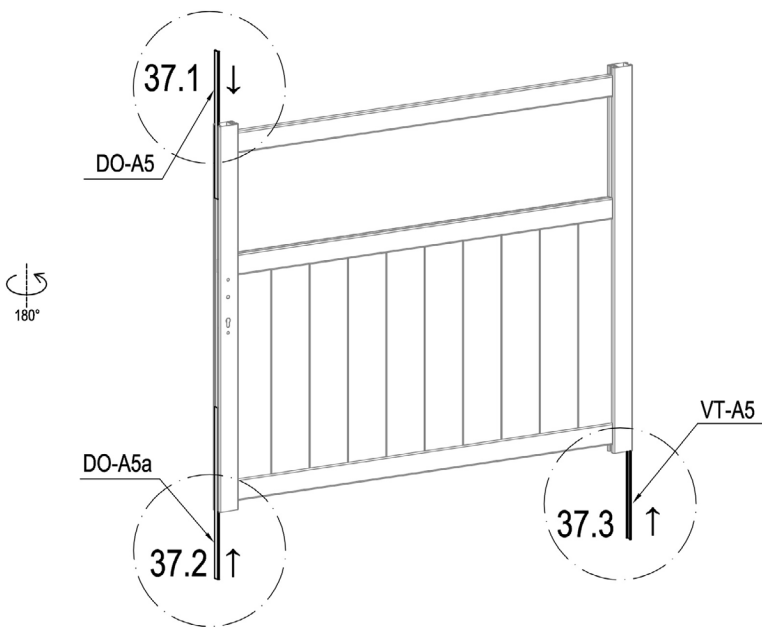

	VT-A5	1
	DO-A5	1
	DO-A5a	1

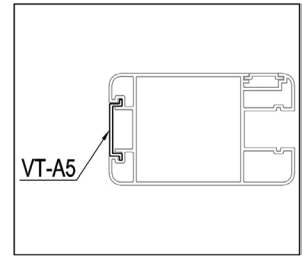

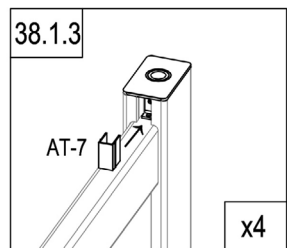
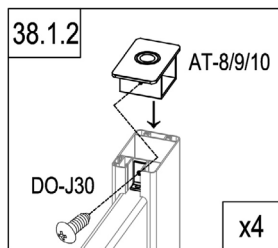
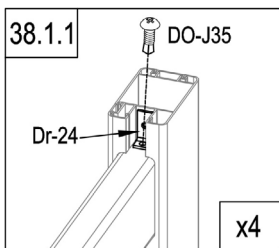
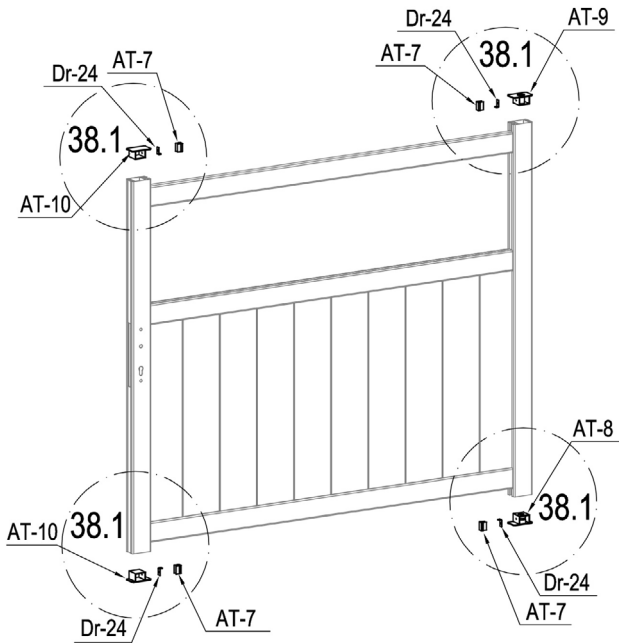

	AT-8	1
	AT-9	1
	AT-10	2
	Dr-24	4

	AT-7	4
	DO-J30	4
	DO-J35	4

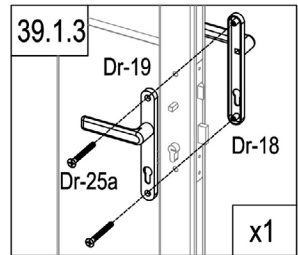
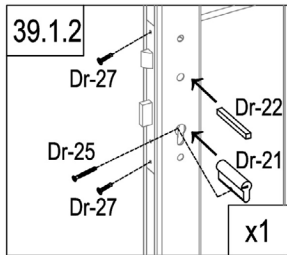
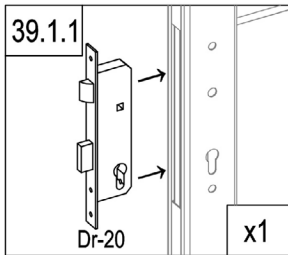
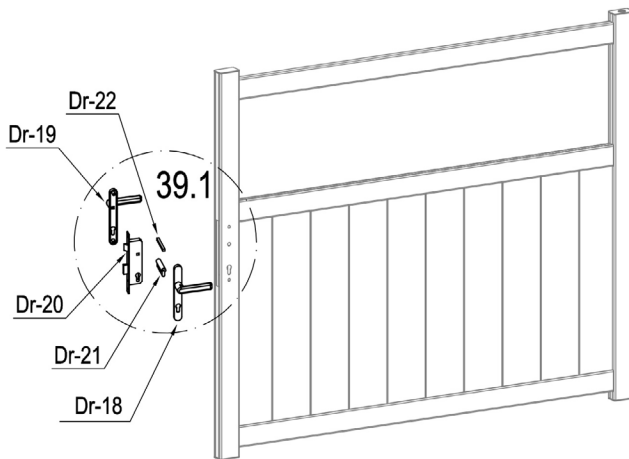

	Dr-20	1
	Dr-21	1
	Dr-22	1
	Dr-25	1

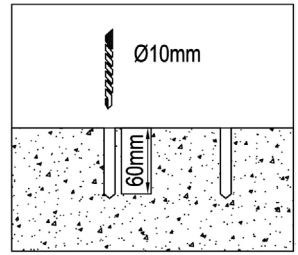
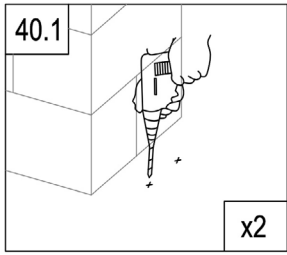
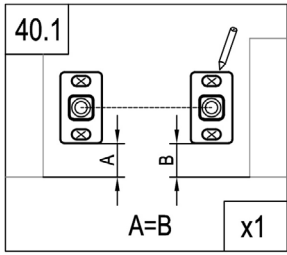
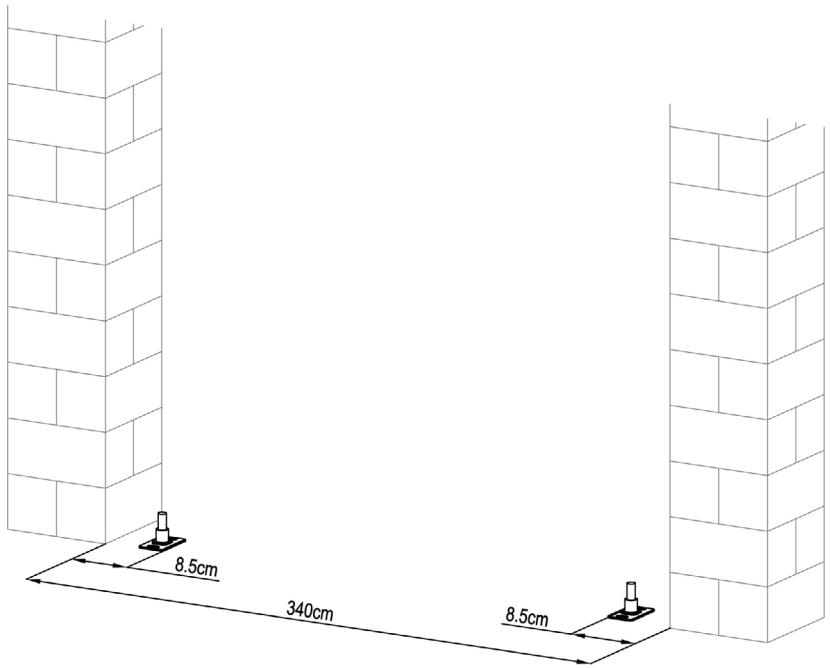

	Dr-18	1
	Dr-19	1
	Dr-25a	2
	Dr-27	2



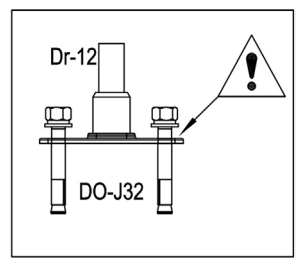
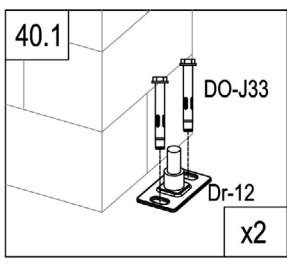

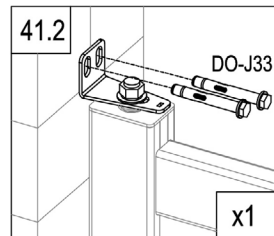
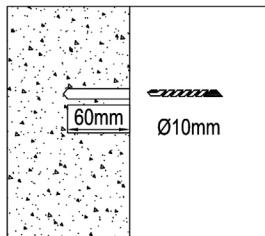
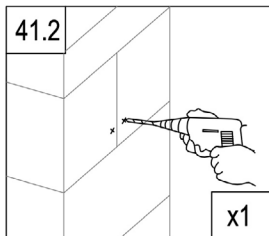
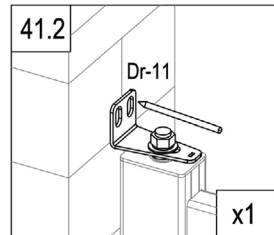
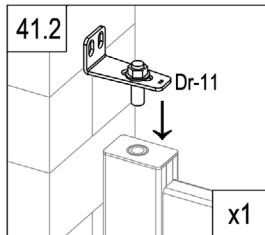
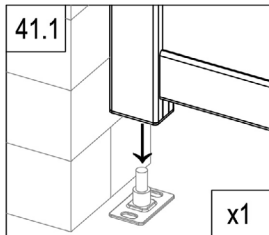
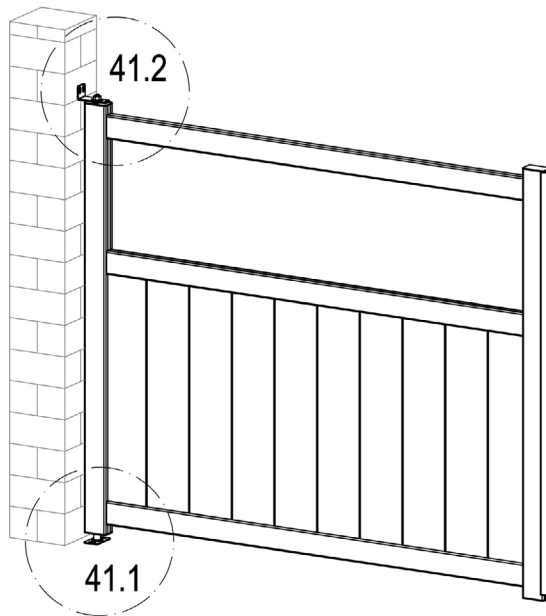
	Dr-12	2
	DO-J33	4



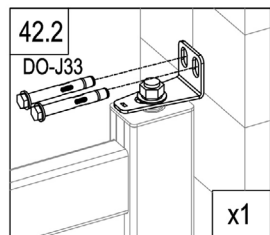
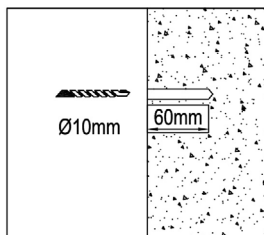
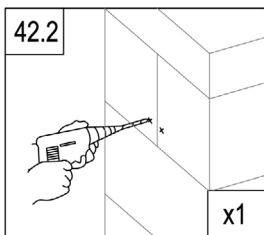
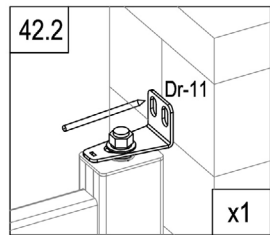
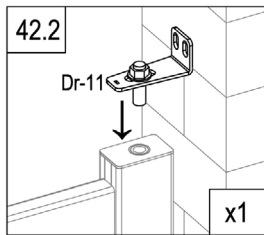
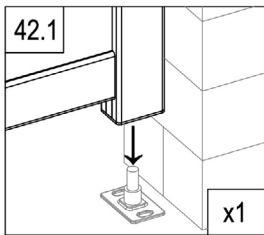
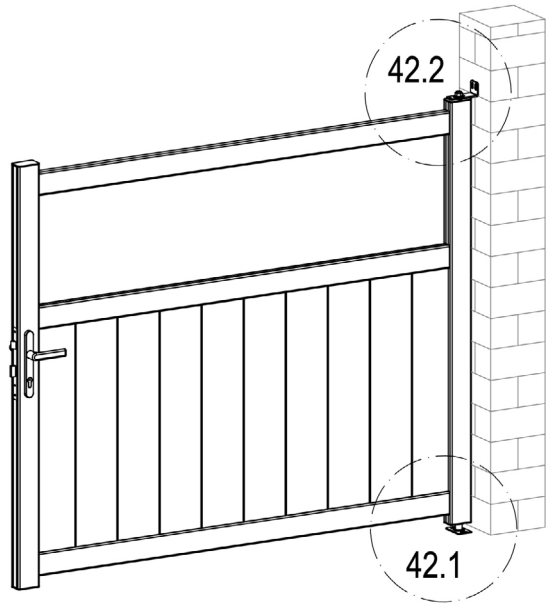

	Dr-11	1
	DO-J33	2



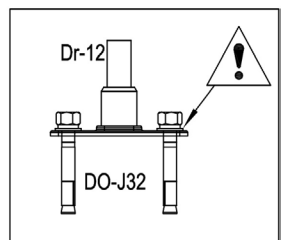
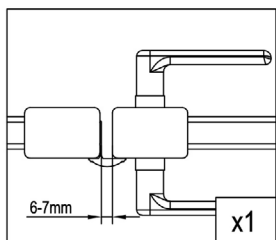
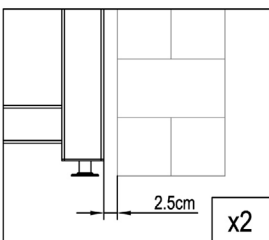
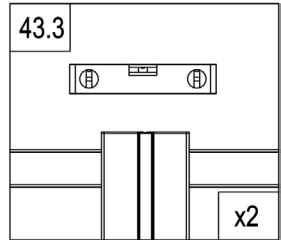
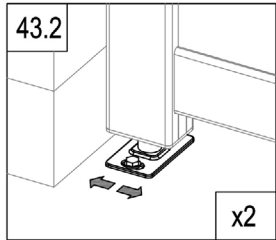
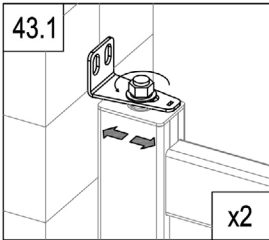
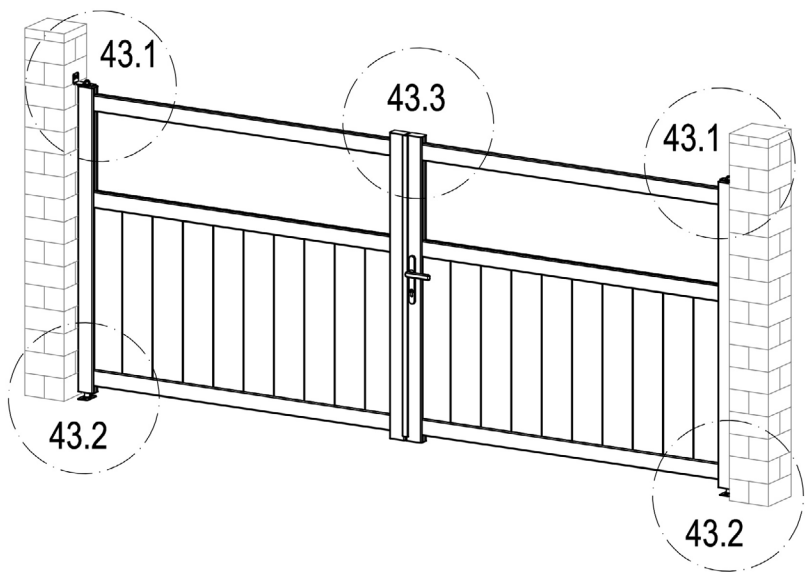
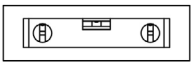

	Dr-11	1
	DO-J33	2

# CASANOVO

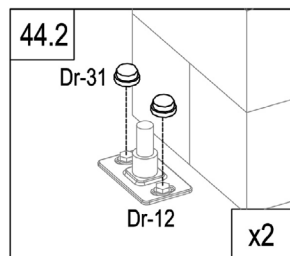
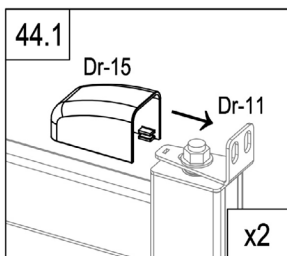
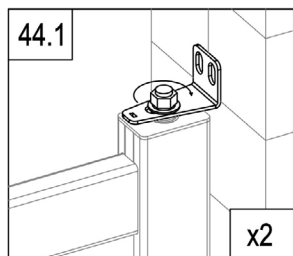
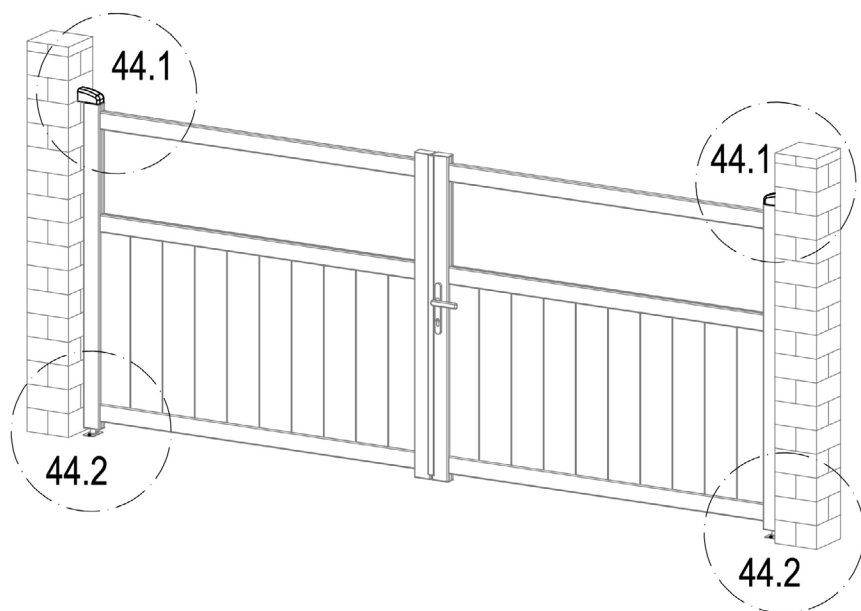





	Dr-15	2
	Dr-31	4

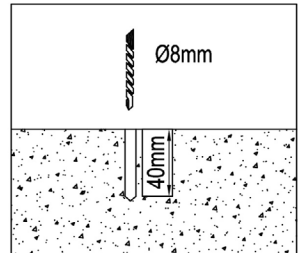
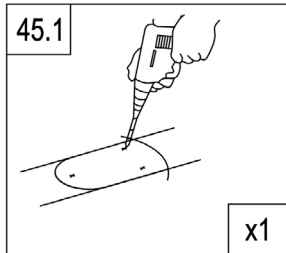
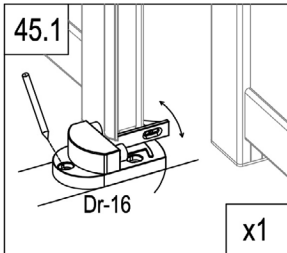
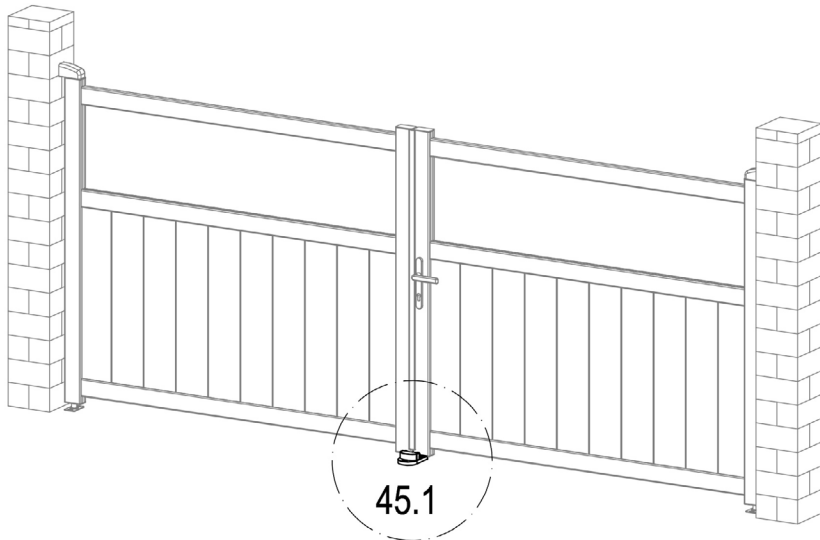



	Dr-16	1
	DO-J34	3
	DO-J36	3

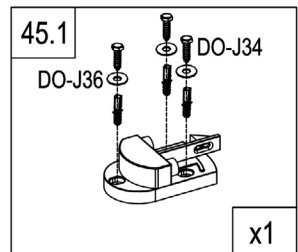

# CASANOVO

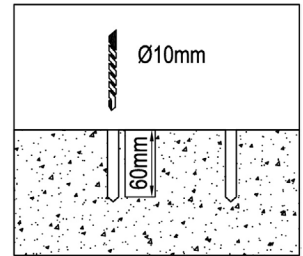
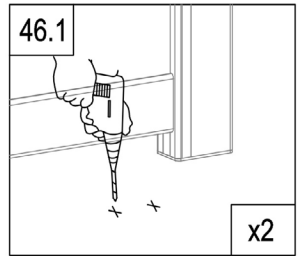
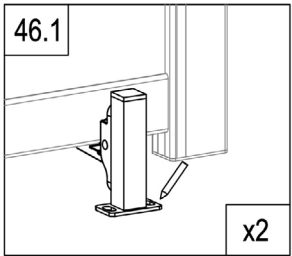
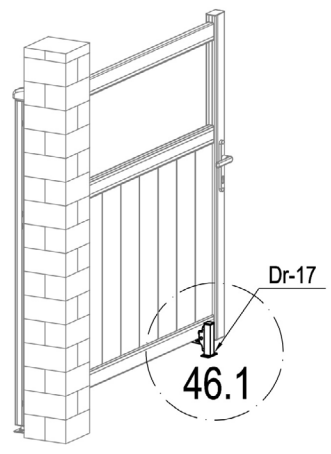
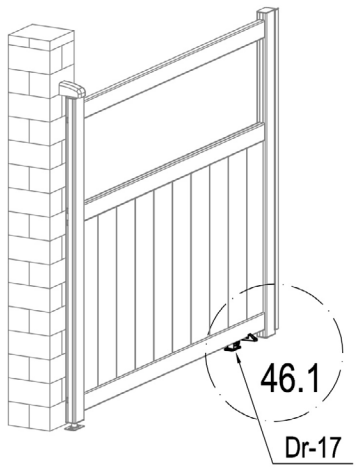

	DO-J33	4
	Dr-17	2

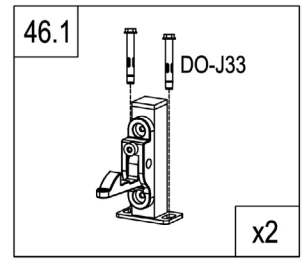

# CASANOVO

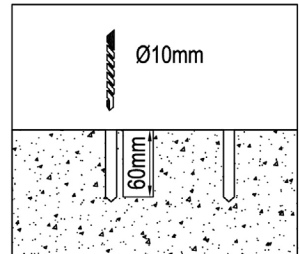
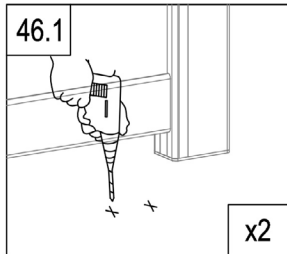
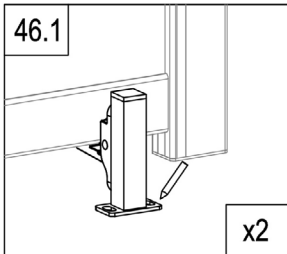
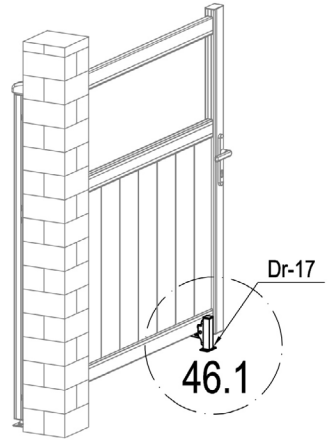
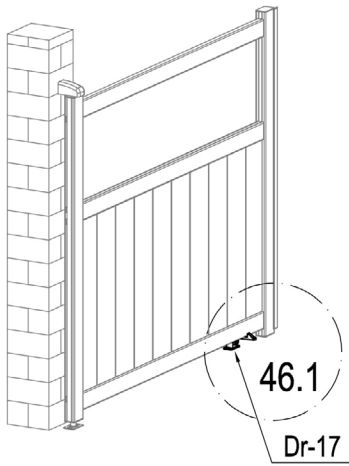

	DO-J33	4
	Dr-17	2

