

CASANOVO

HALTI 340B140

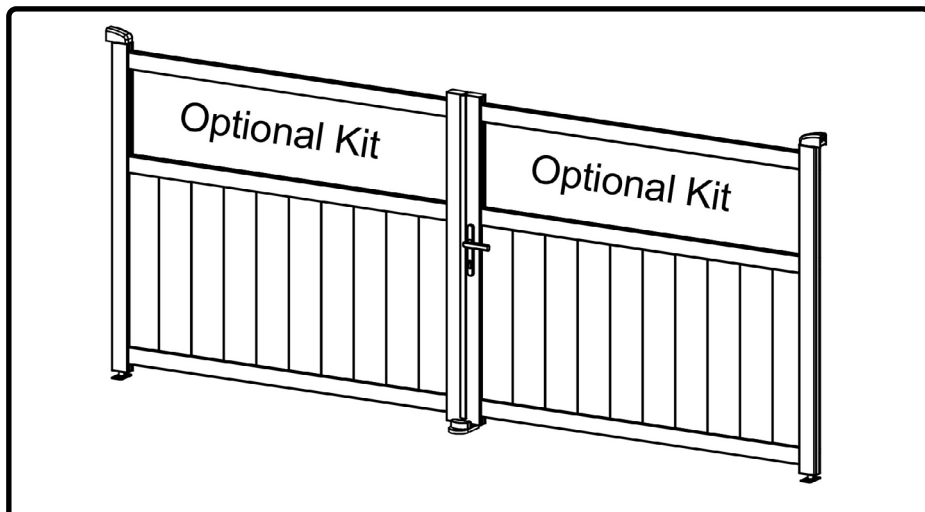

COM-001126 [x1]

COM-001133 [x1]

COM-001127 [x1]



EN FR DE ES PT IT NL PL FI SE DK

RO SI SK HU CZ HR GR LT LV



INSTRUCTION MANUAL / NOTICE DE MONTAGE / MONTAGEANLEITUNG / MANUAL DE MONTAJE / MANUAL DE MONTAGEM / MANUALE DI MONTAGGIO /
MONTAGEHANDLEIDING / INSTRUKCJA MONTAŻU / KÄYTTÖOHJEET / BRUGSANVISNING / BRUGSANVISNING / INSTRUCȚIUNI DE ASAMBLARE /
NAVODILA ZA SESTAVLJANJE / NÁVOD NA MONTÁŽ / ÖSSZESZERELÉSI ÚTMUTATÓ / NÁVOD K MONTÁŽI / UPUTE ZA INSTALACIJU /
ΟΔΗΓΙΕΣ ΣΥΝΑΡΜΟΛΟΓΗΣΗΣ / SURINKIMO INSTRUKCIJOS / MONTĀŽAS INSTRUKCIJAS

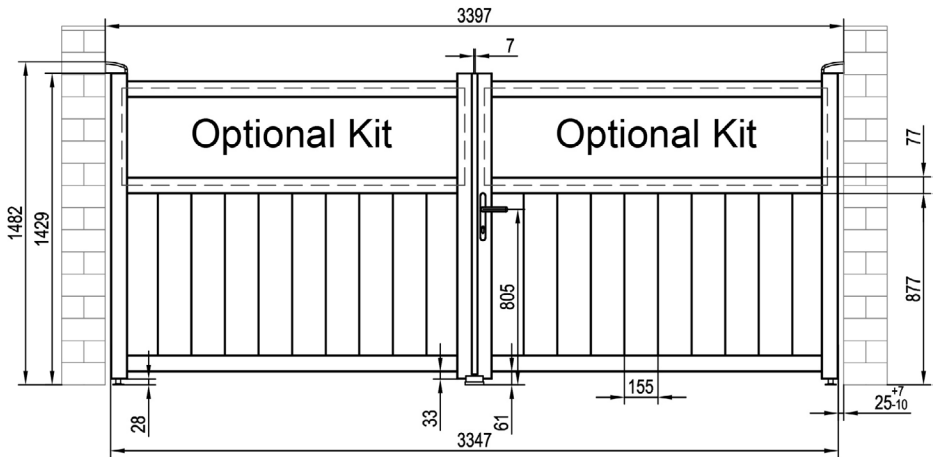

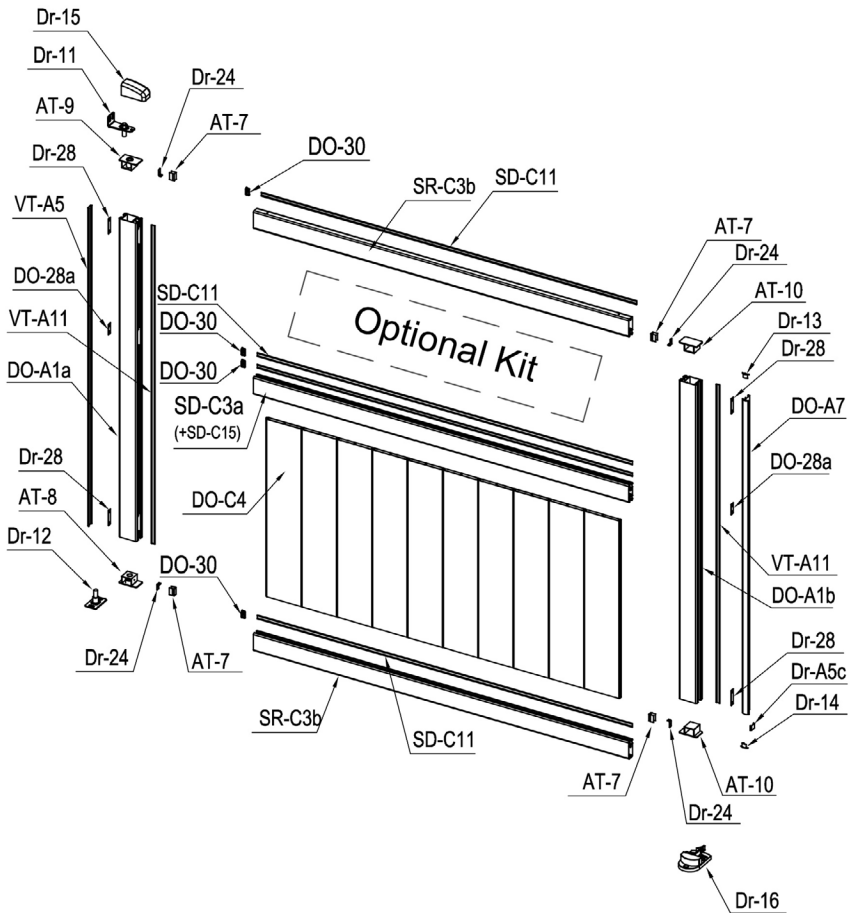
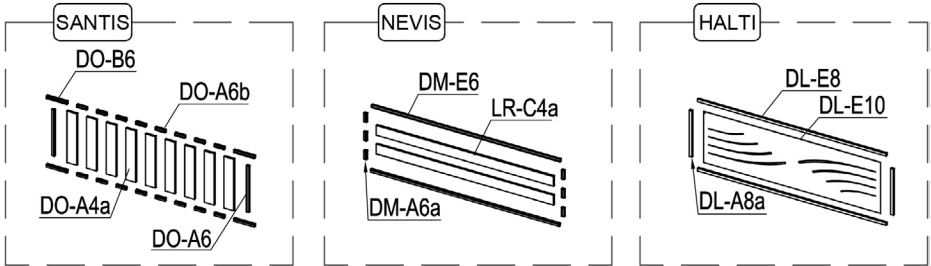



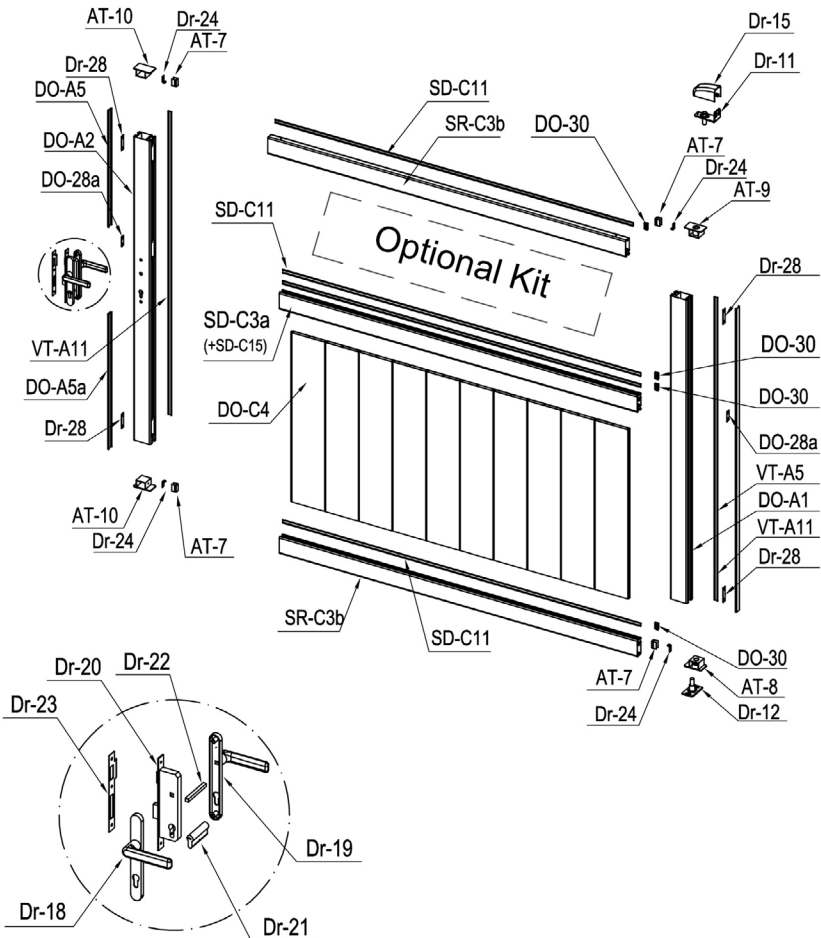
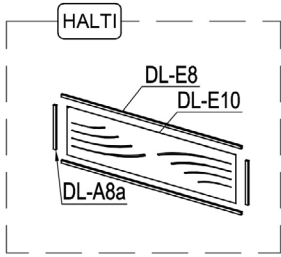
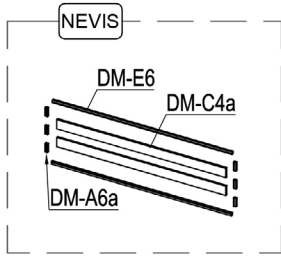
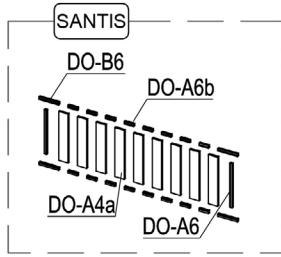











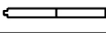



























CASANOVO











PARTS LIST

| IMAGE | NO. | L.(mm) | QTY | IMAGE | NO. | L.(mm) | QTY |
|---|---------------------|--------|-----|---|--------|----------|-----|
|  | DO-A1 | 1395 | 1 |  | Dr-20 | | 1 |
| | DO-A1a | 1395 | 1 |  | Dr-21 | | 1 |
| | DO-A1b | 1395 | 1 |  | Dr-22 | | 1 |
| | DO-A2 | 1395 | 1 |  | Dr-23 | | 1 |
|  | SR-C3b | 1647 | 4 |  | Dr-25 | | 1 |
|  | SD-C3a (+SD-C15) | 1647 | 2 |  | Dr-25a | | 2 |
|  | DO-C4 | 779 | 20 |  | Dr-26 | | 3 |
|  | VT-A5 | 1395 | 2 |  | Dr-27 | | 2 |
| | DO-A5 | 532.5 | 1 |  | Dr-24 | | 8 |
| | DO-A5a | 622 | 1 |  | Dr-28 | | 8 |
| | Dr-A5c | 19.5 | 1 |  | DO-28a | | 4 |
|  | VT-A11 | 1395 | 4 |  | DO-J30 | ST4x10 | 8 |
| | SD-C11 | 1647 | 8 |  | DO-J31 | ST5.5x38 | 24 |
|  | AT-7 | 29.5 | 8 |  | DO-J32 | ST4.8x38 | 12 |
|  | DO-A7 | 1375 | 1 |  | DO-J33 | M8x60 | 12 |
|  | AT-8 | | 2 |  | DO-J34 | ST6x40 | 3 |
|  | AT-9 | | 2 |  | DO-J35 | ST4.2x13 | 48 |
|  | AT-10 | | 4 |  | DO-J36 | Ø6 | 3 |
|  | Dr-11 | | 2 | | | | |
|  | Dr-12 | | 2 | | | | |
|  | Dr-13 | | 1 | | | | |
|  | Dr-14 | | 1 | | | | |
|  | Dr-15 | | 2 | | | | |
|  | Dr-16 | | 1 | | | | |
|  | Dr-17 | | 2 | | | | |
|  | Dr-31 | | 4 | | | | |
|  | DO-30 | | 8 | | | | |
|  | Dr-18 | | 1 | | | | |
|  | Dr-19 | | 1 | | | | |

PARTS LIST (Optional Kit)

| <p>Com-001131</p>  | IMAGE | NO. | L.(mm) | QTY |
|---|---|--------|--------|-----|
| |  | DO-A4a | 406 | 18 |
| |  | DO-A6 | 364 | 4 |
| | | DO-B6 | 163 | 8 |
| | | DO-A6b | 77.5 | 32 |
|  | DO-35 | | 36 | |

| <p>Com-001132</p>  | IMAGE | NO. | L.(mm) | QTY |
|--|--|--------|--------|-----|
| |  | LR-C4a | 1555 | 4 |
| |  | DM-E6 | 1645 | 4 |
| | | DM-A6a | 69 | 12 |
|  | DO-32 | | 8 | |

| <p>Com-001133</p>  | IMAGE | NO. | L.(mm) | QTY |
|---|---|--------|--------|-----|
| |  | DL-E8 | 1645 | 4 |
| | | DL-A8a | 364 | 4 |
| |  | DL-E10 | 1552 | 2 |
| |  | DO-32 | | 8 |
|  | DO-35 | | 16 | |

CASANOVO

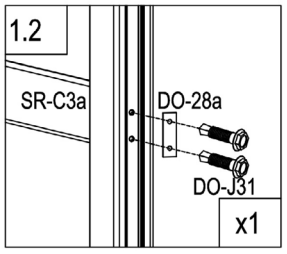
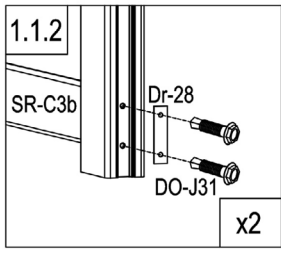
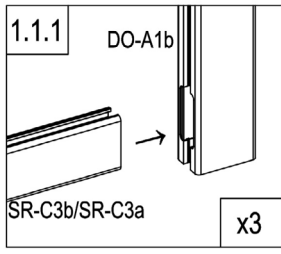
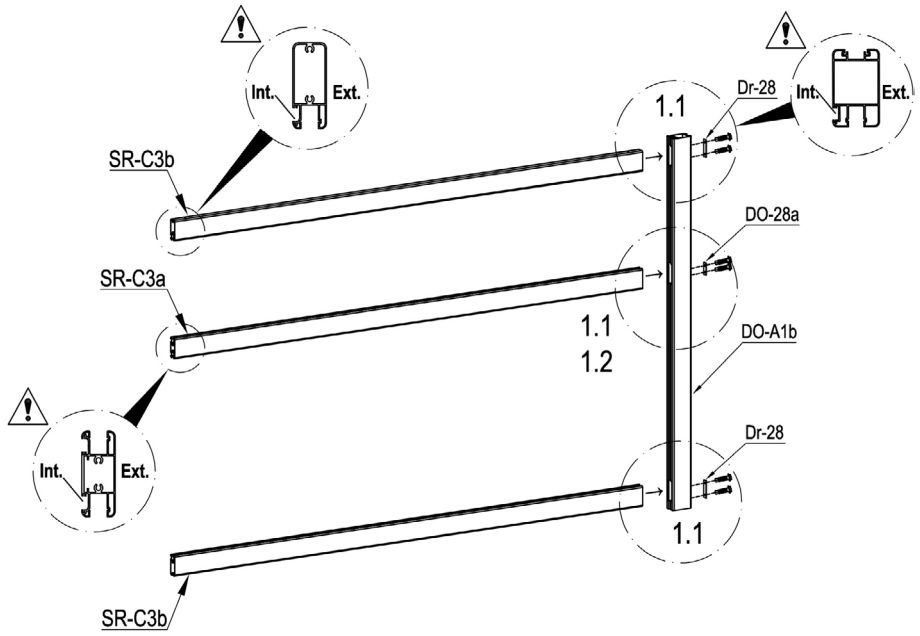

| | | |
|--|--------|---|
| | DO-A1b | 1 |
| | SR-C3b | 2 |
| | SR-C3a | 1 |

| | | |
|--|--------|---|
| | Dr-28 | 2 |
| | DO-28a | 1 |
| | DO-J31 | 6 |

CASANOVO

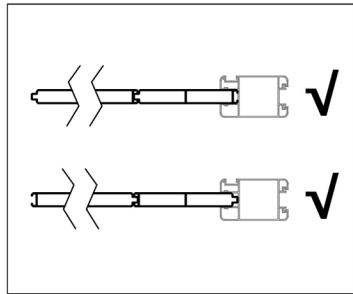
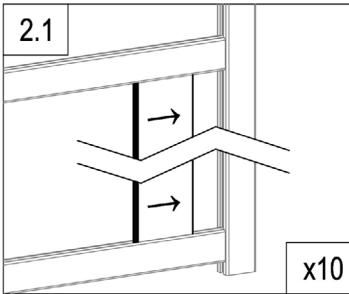
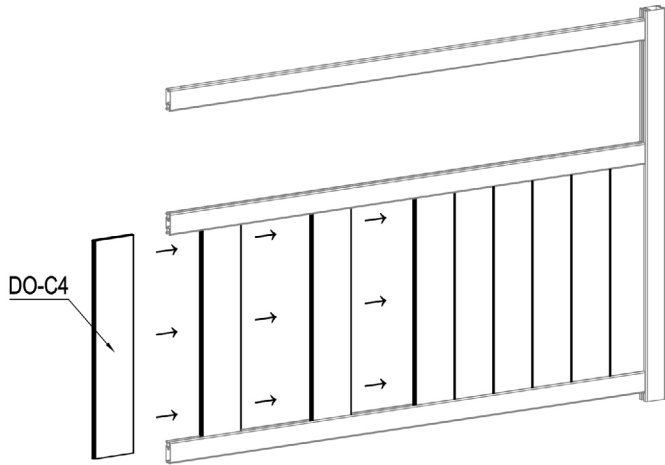

| | | |
|---|-------|----|
|  | DO-C4 | 10 |
|---|-------|----|

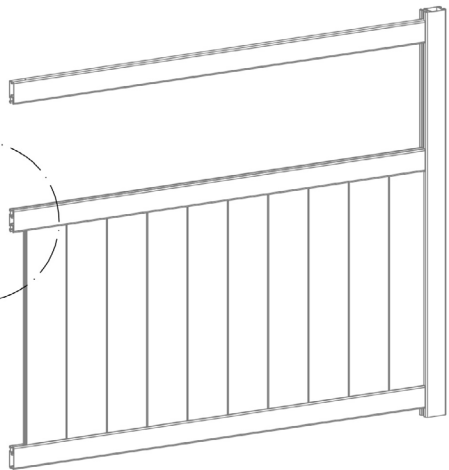
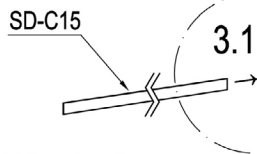

- EN: reinforced slat for automation
- FR : lame renforcée pour l'automatisation
- DE : verstärkte Lamelle für die Automatisierung
- ES: Lámina reforzada para la automatización
- PT: ripa reforçada para automatização
- IT: lamella rinforzata per l'automazione
- NL: versterkte lat voor automatisering
- PL: wzmocniona listwa do automatyzacji

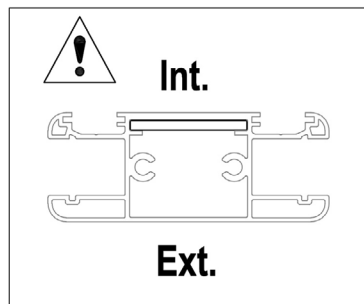
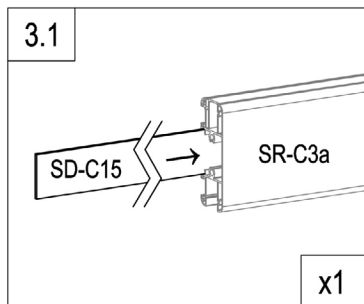

| | | |
|---|--------|---|
|  | SD-C15 | 1 |
|---|--------|---|

Optional Kit →

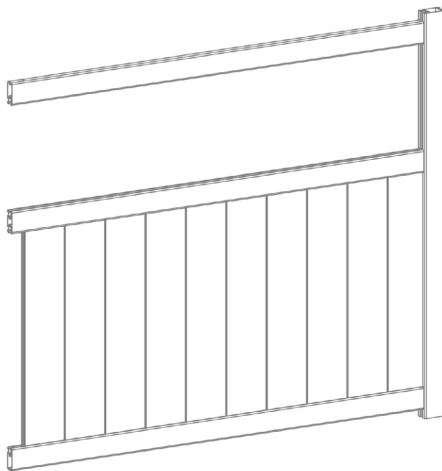

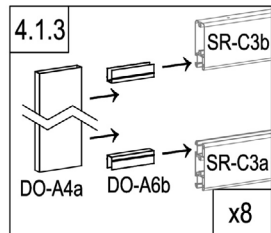
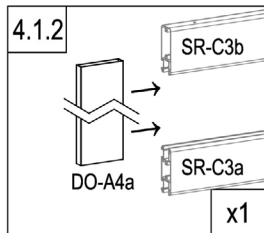
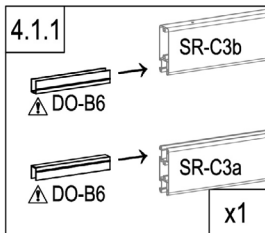
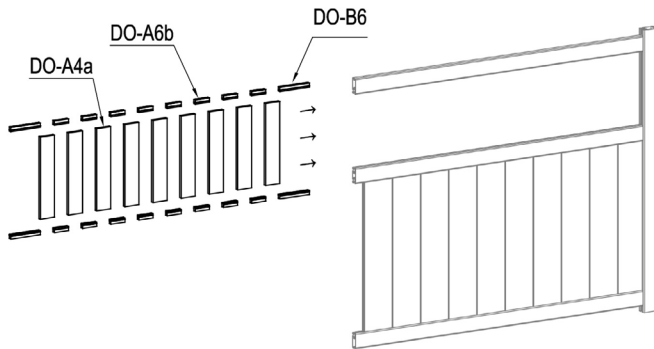

| | | | |
|--|--------|--------|----|
| | DO-A4a | 406mm | 9 |
| | DO-B6 | 163mm | 4 |
| | DO-A6b | 77.5mm | 16 |

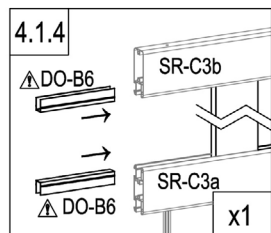

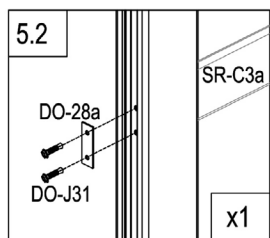
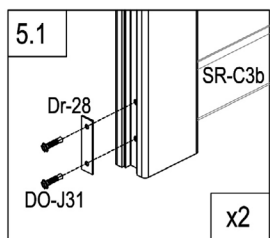
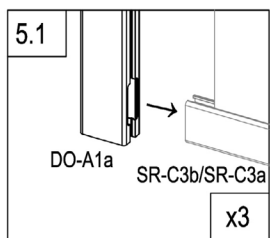
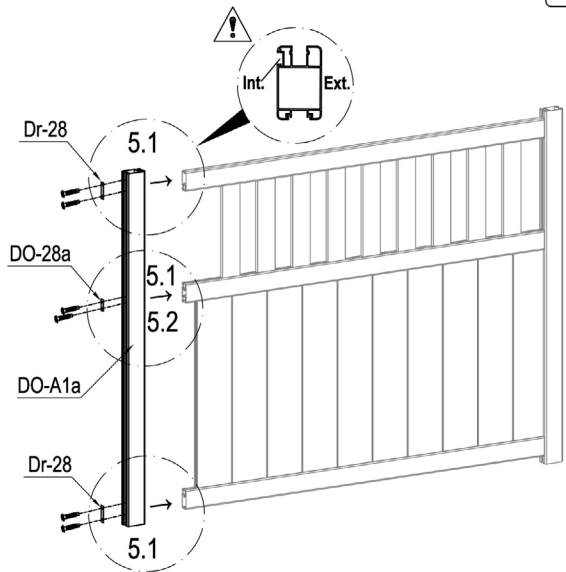

| | | |
|--|--------|---|
| | DO-A1a | 1 |
| | Dr-28 | 2 |
| | DO-28a | 1 |
| | DO-J31 | 6 |

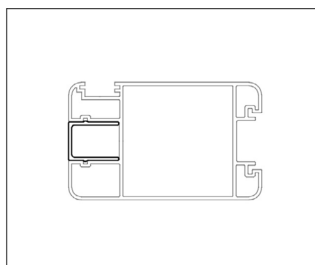
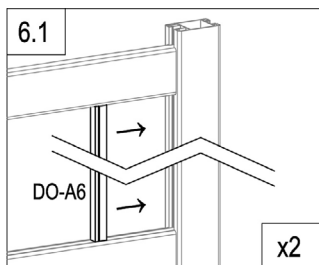
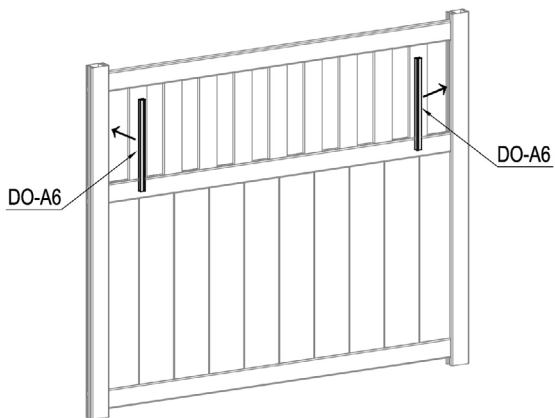

| | | |
|--|-------|---|
| | DO-A6 | 2 |
|--|-------|---|

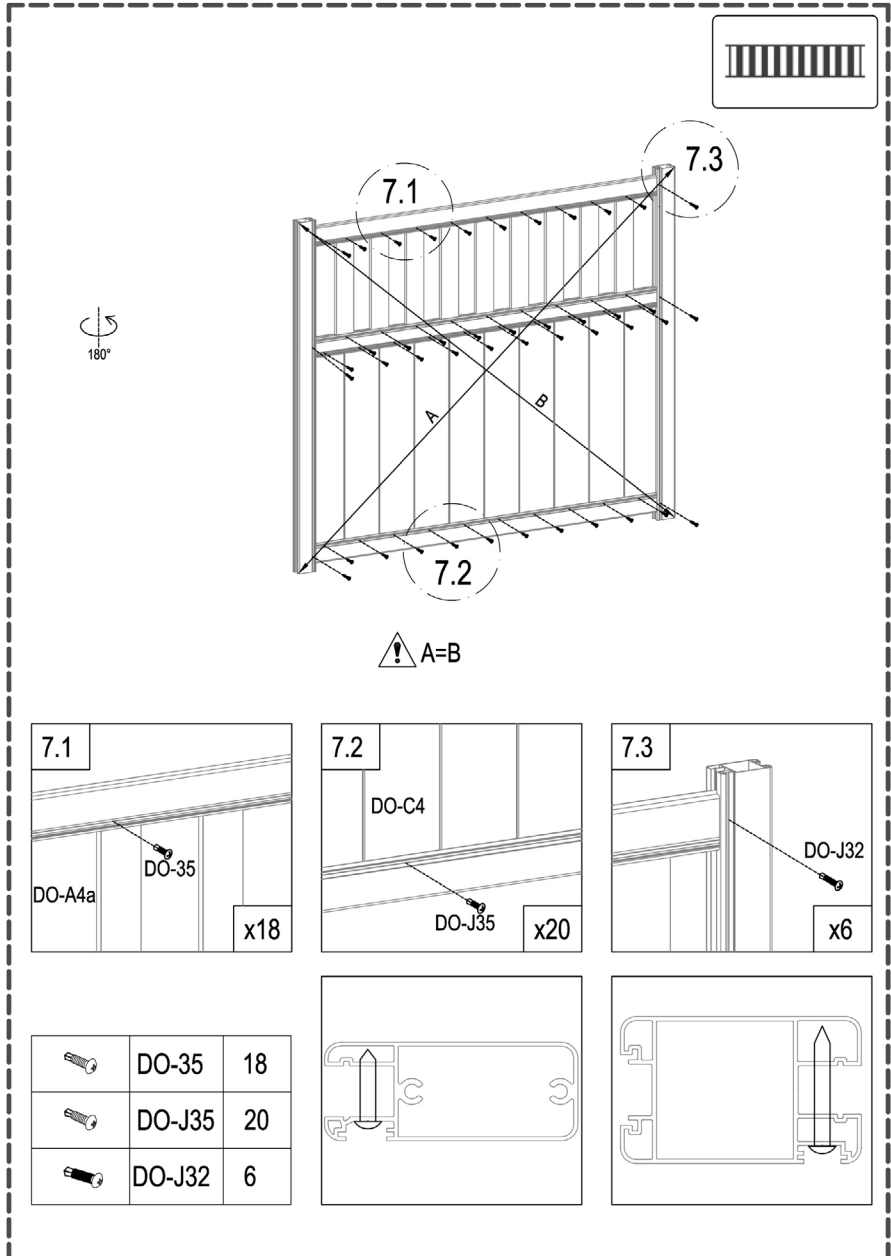

180°

! A=B

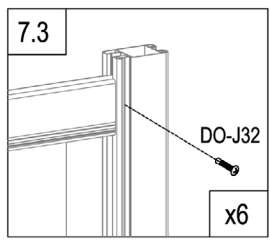
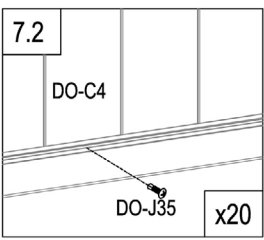
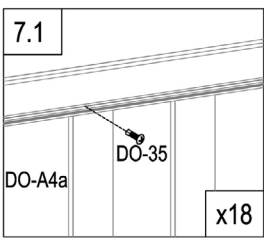

| | | |
|--|--------|----|
| | DO-35 | 18 |
| | DO-J35 | 20 |
| | DO-J32 | 6 |

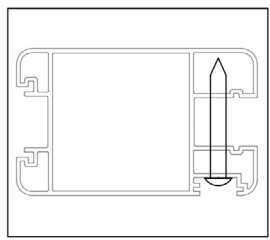
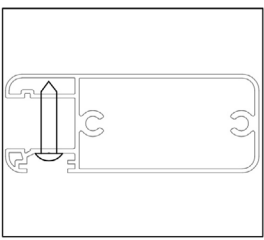

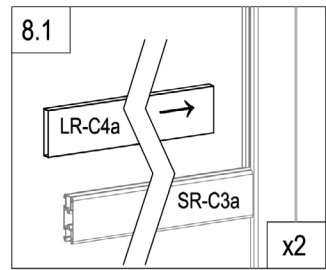
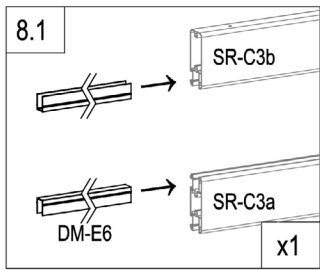
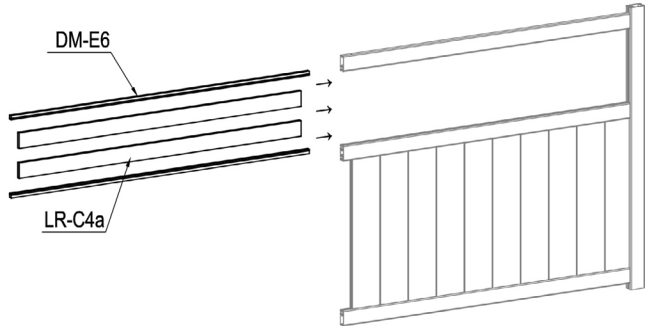

| | | |
|---|--------|---|
|  | LR-C4a | 2 |
|  | DM-E6 | 2 |

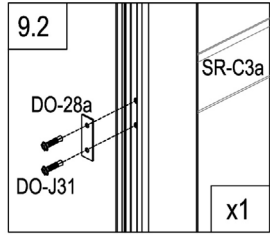
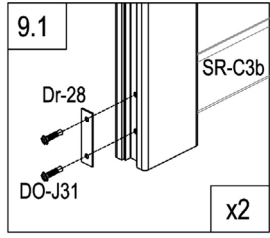
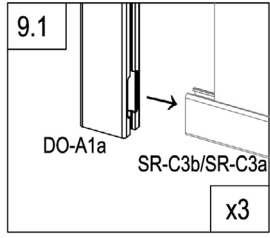
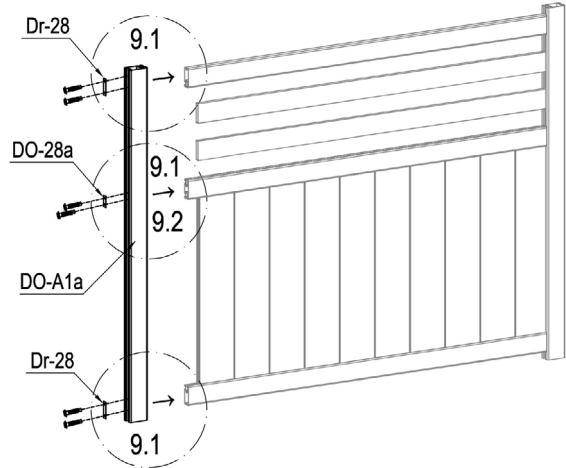
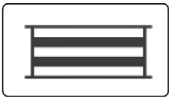

| | | |
|--|--------|---|
| | DO-A1a | 1 |
| | Dr-28 | 2 |
| | DO-28a | 1 |
| | DO-J31 | 6 |

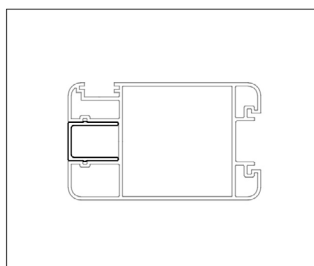
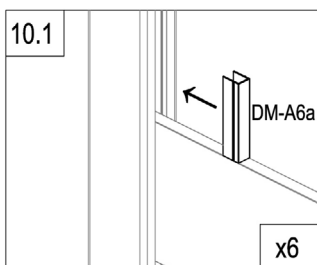
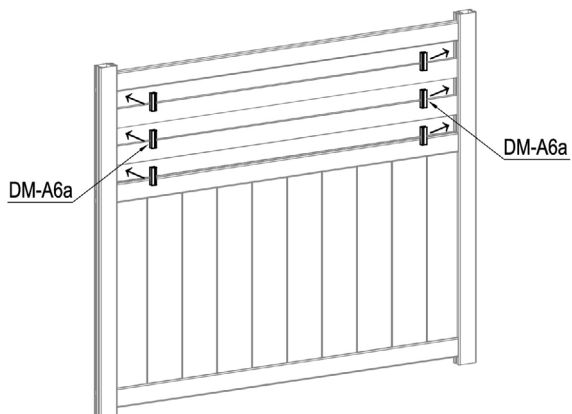

| | | |
|--|--------|---|
| | DM-A6a | 6 |
|--|--------|---|

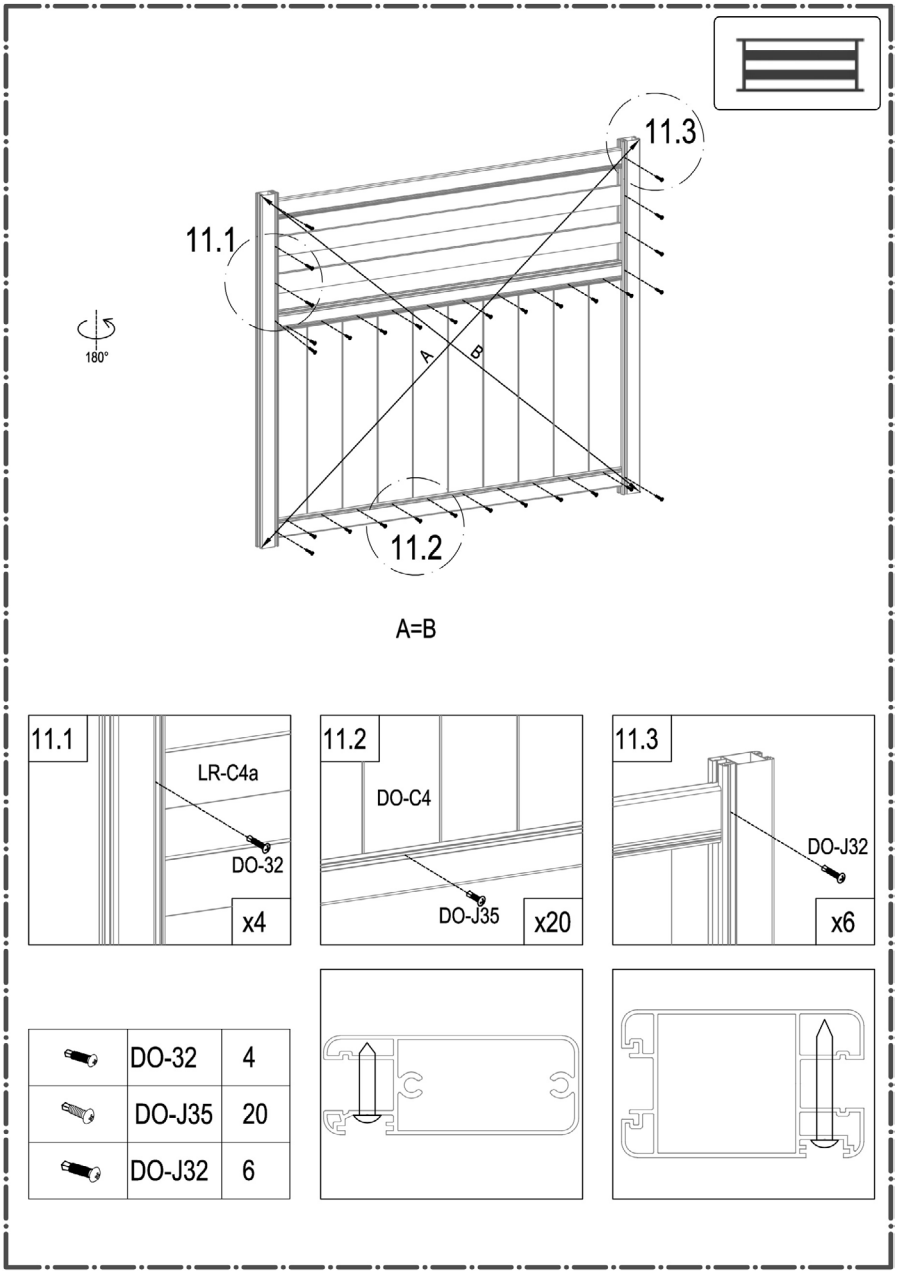

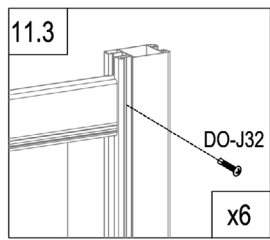
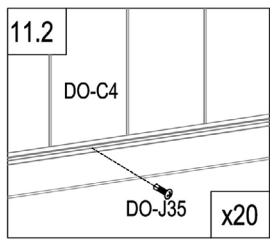
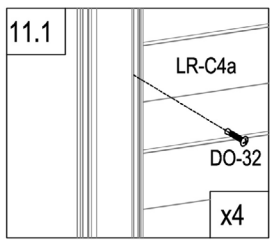

A=B

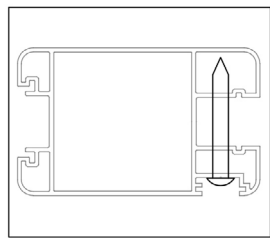
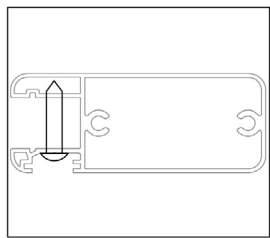

| | | |
|--|--------|----|
| | DO-32 | 4 |
| | DO-J35 | 20 |
| | DO-J32 | 6 |

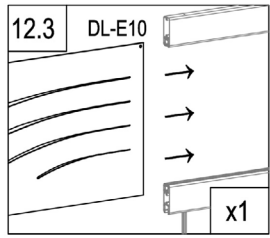
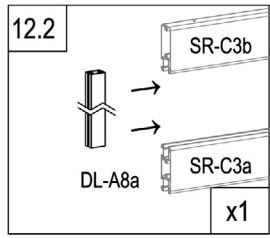
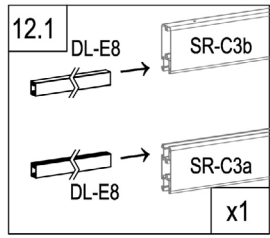
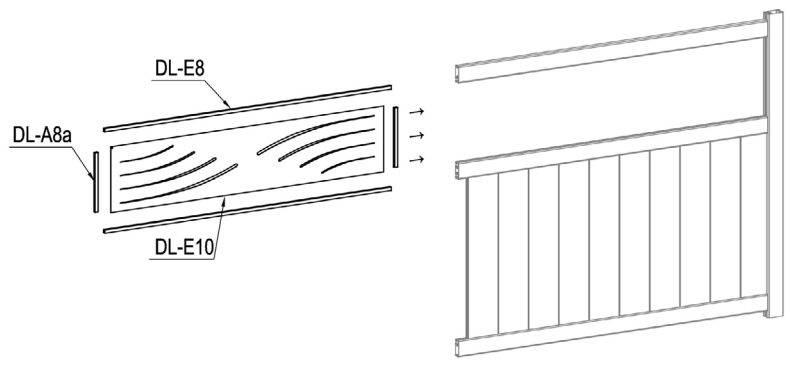



| | | |
|---|--------|---|
|  | DL-E10 | 1 |
|  | DL-E8 | 2 |
| | DL-A8a | 2 |

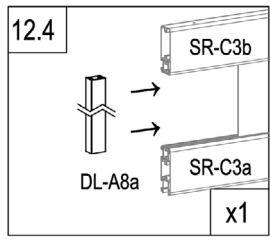

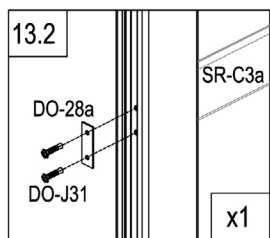
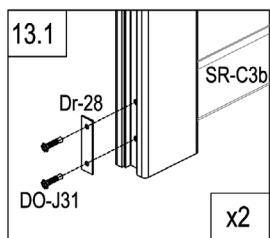
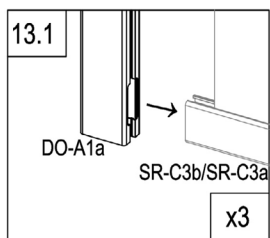
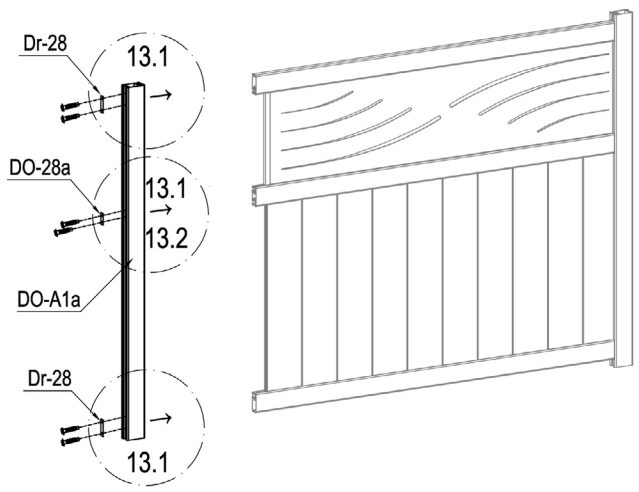

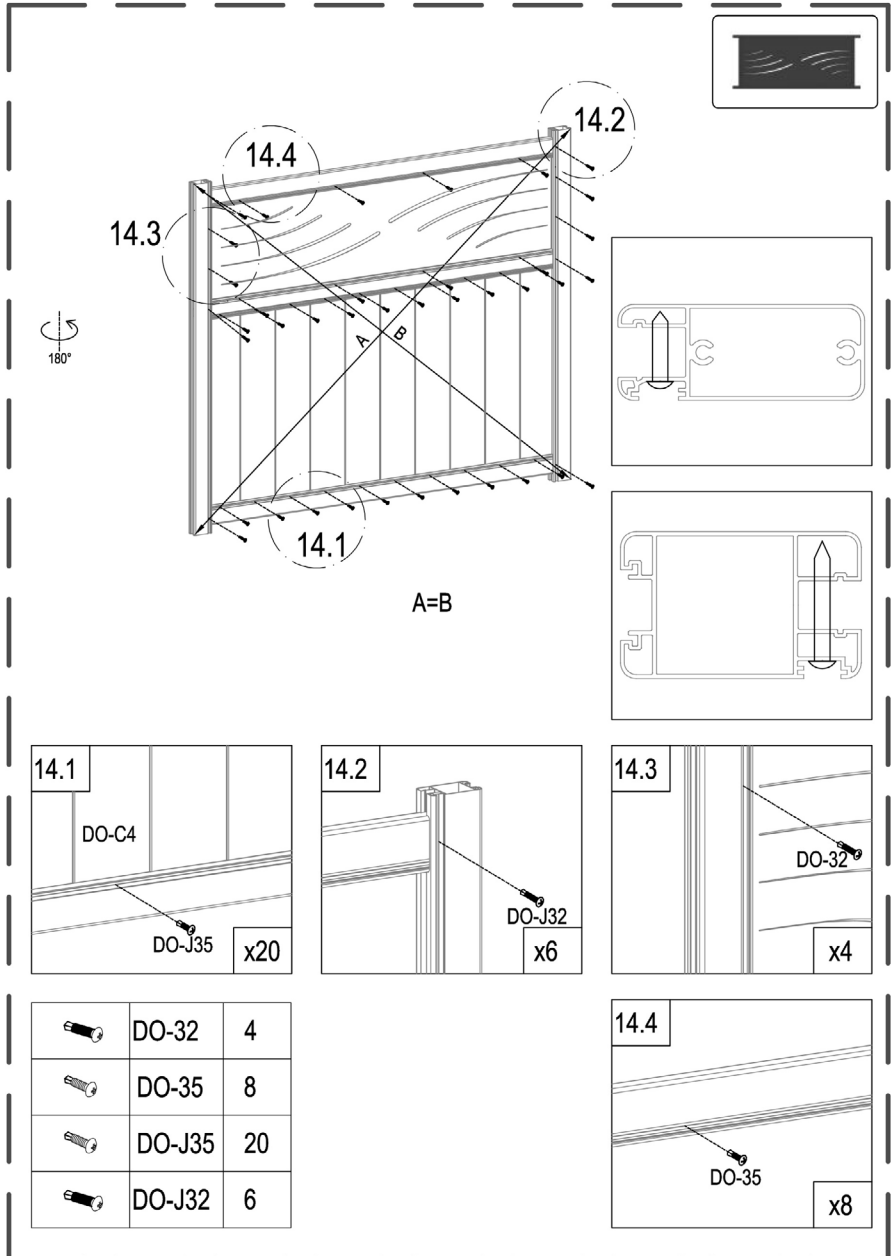

| | | |
|--|--------|---|
| | DO-A1a | 1 |
| | Dr-28 | 2 |
| | DO-28a | 1 |
| | DO-J31 | 6 |

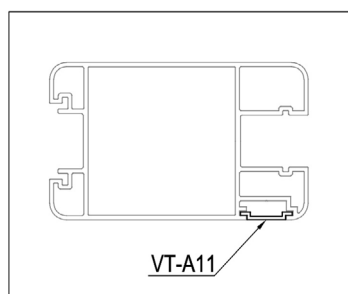
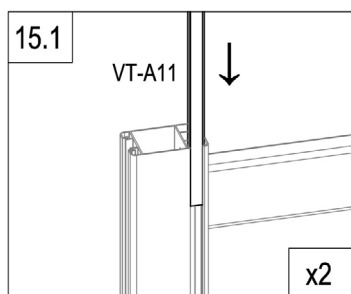
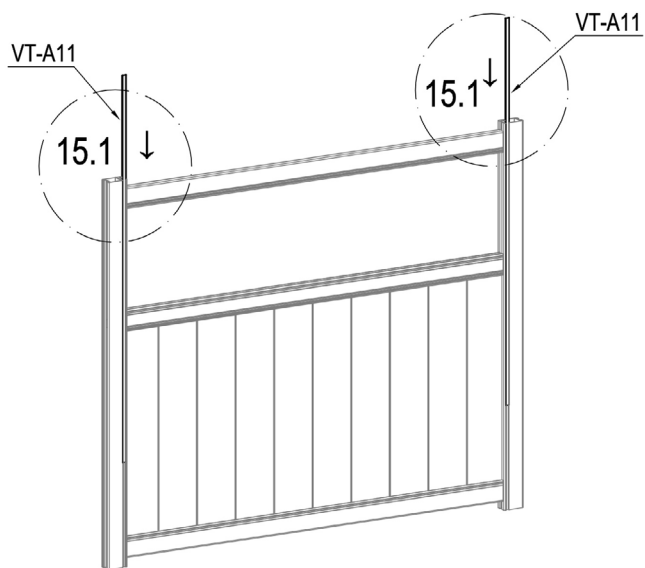



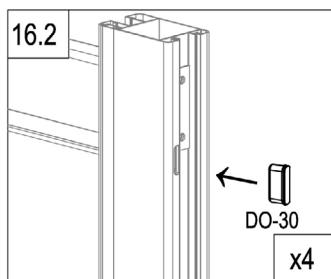
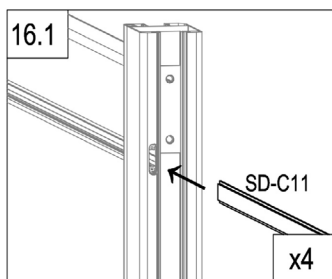
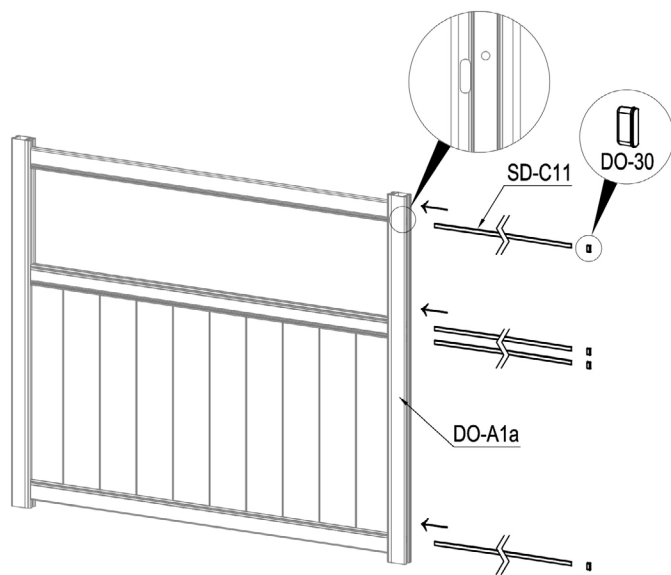

| | | |
|---|--------|---|
|  | VT-A11 | 2 |
|---|--------|---|

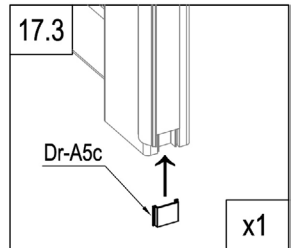
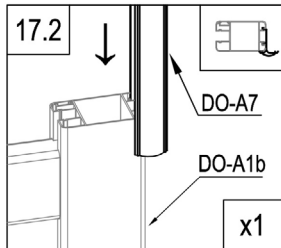
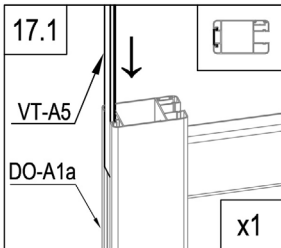
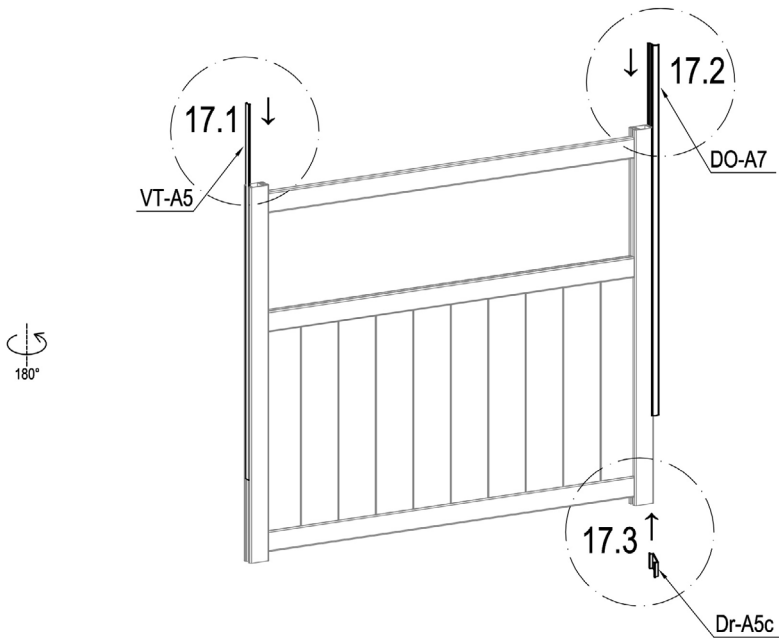

| | | |
|---|--------|---|
|  | SD-C11 | 4 |
|  | DO-30 | 4 |



| | | |
|---|--------|---|
|  | VT-A5 | 1 |
| | Dr-A5c | 1 |
|  | DO-A7 | 1 |

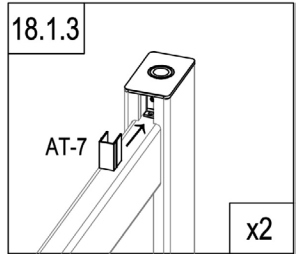
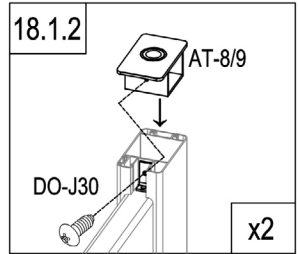
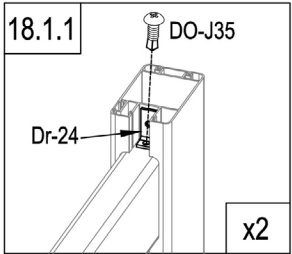
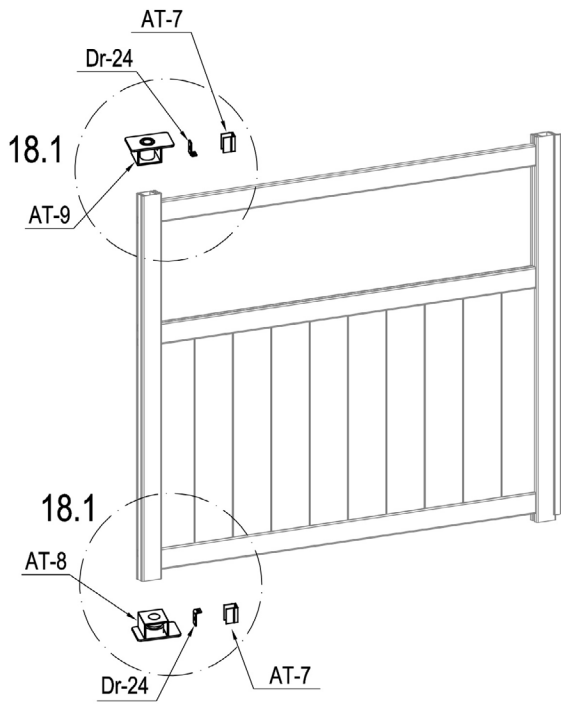

| | | |
|--|-------|---|
| | AT-8 | 1 |
| | AT-9 | 1 |
| | Dr-24 | 2 |

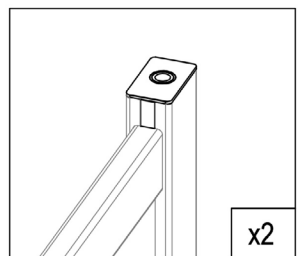

| | | |
|--|--------|---|
| | AT-7 | 2 |
| | DO-J30 | 2 |
| | DO-J35 | 2 |

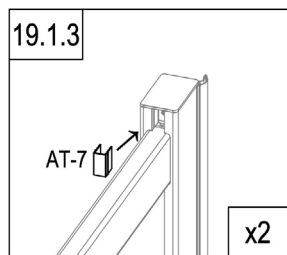
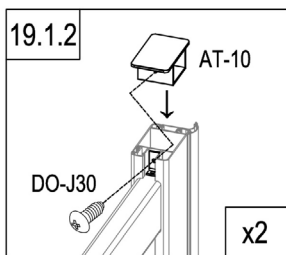
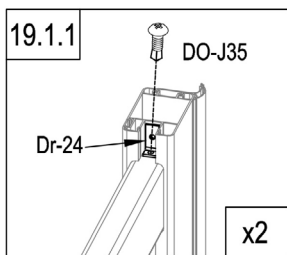
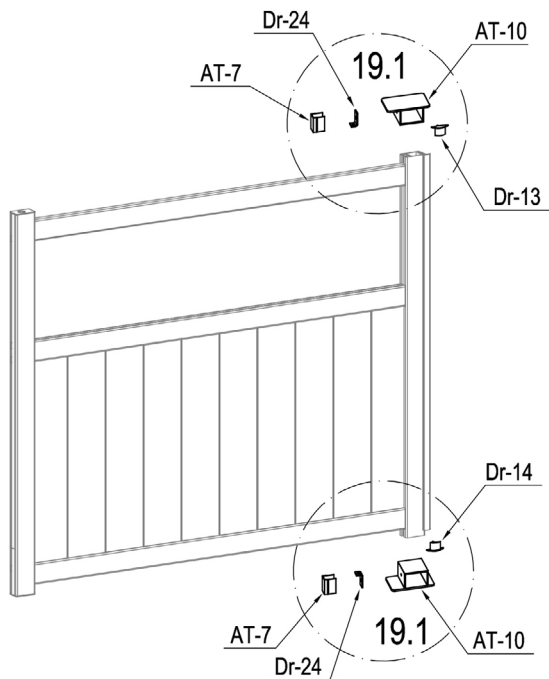

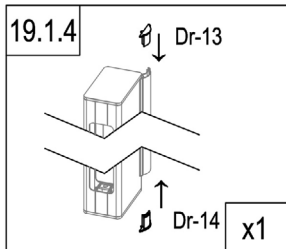

| | | |
|--|-------|---|
| | AT-10 | 2 |
| | Dr-24 | 2 |
| | AT-7 | 2 |
| | Dr-13 | 1 |

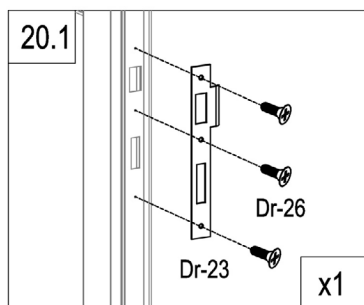
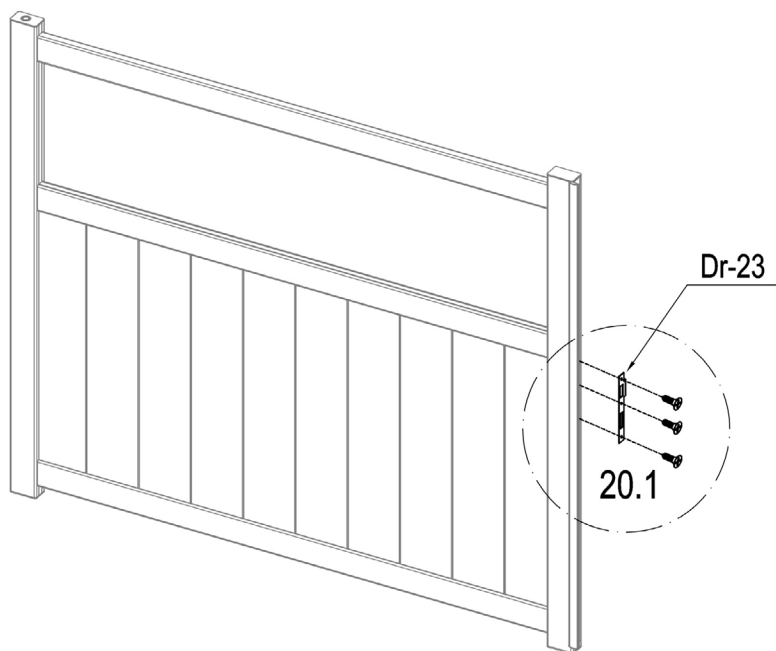

| | | |
|--|--------|---|
| | Dr-14 | 1 |
| | DO-J30 | 2 |
| | DO-J35 | 2 |



| | | |
|---|-------|---|
|  | Dr-23 | 1 |
|  | Dr-26 | 3 |

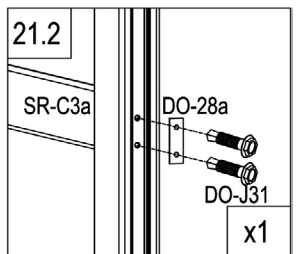
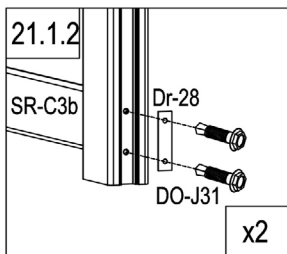
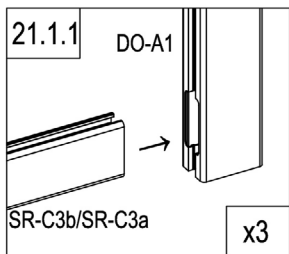
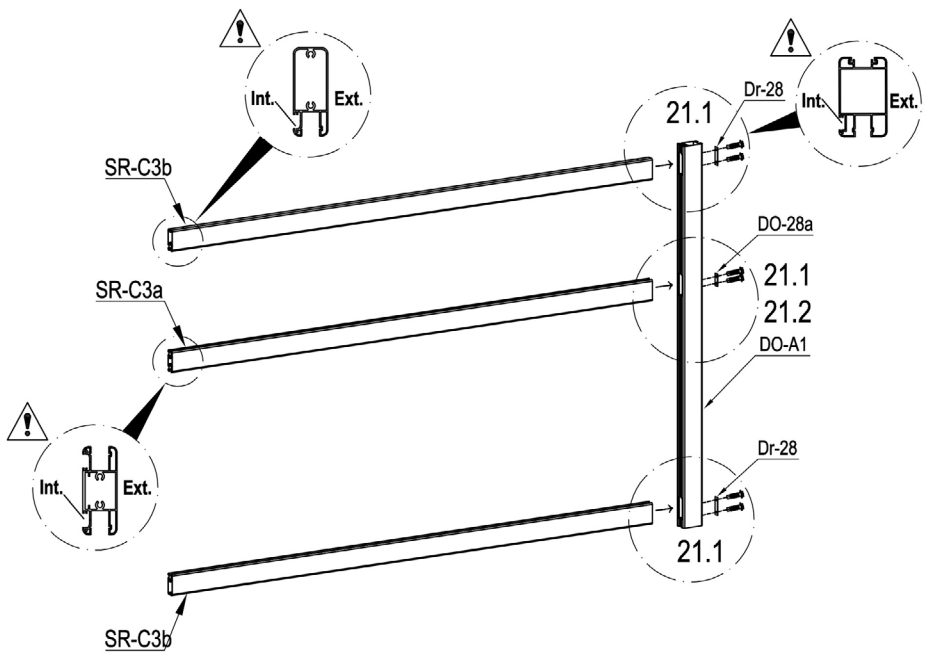

| | | |
|--|--------|---|
| | DO-A1 | 1 |
| | SR-C3b | 2 |
| | SR-C3a | 1 |

| | | |
|--|--------|---|
| | Dr-28 | 2 |
| | DO-28a | 1 |
| | DO-J31 | 6 |

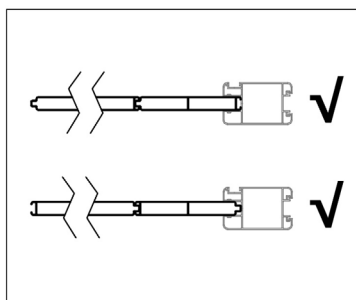
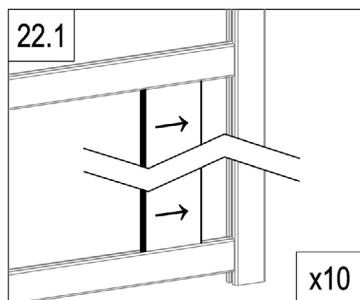
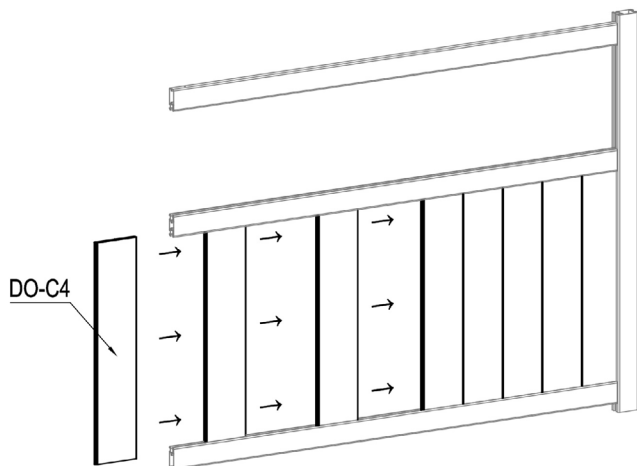

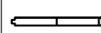
| | | |
|---|-------|----|
|  | DO-C4 | 10 |
|---|-------|----|

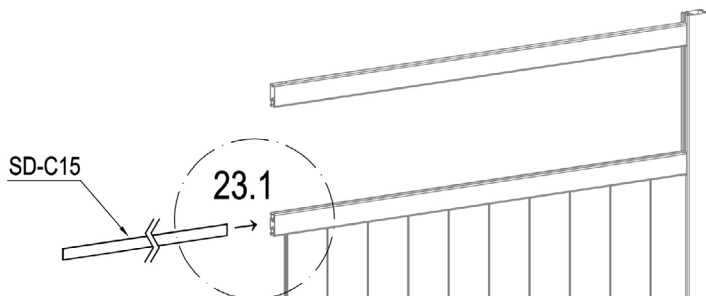

- EN: reinforced slat for automation
- FR : lame renforcée pour l'automatisation
- DE : verstärkte Lamelle für die Automatisierung
- ES: Lámina reforzada para la automatización
- PT: ripa reforçada para automatização
- IT: lamella rinforzata per l'automazione
- NL: versterkte lat voor automatisering
- PL: wzmocniona listwa do automatyzacji

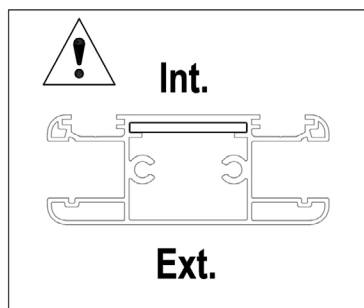
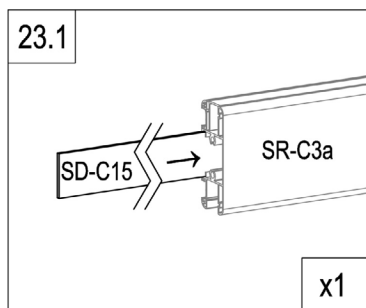

| | | |
|---|--------|---|
|  | SD-C15 | 1 |
|---|--------|---|

Optional Kit →

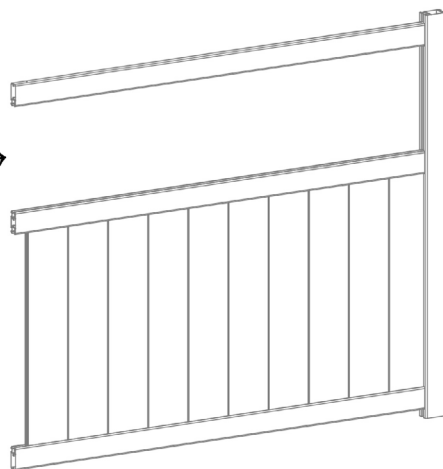

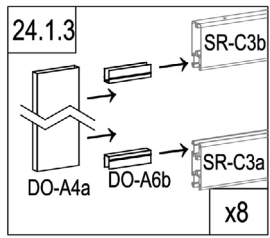
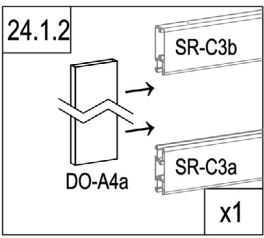
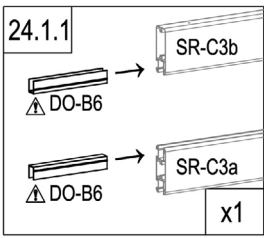
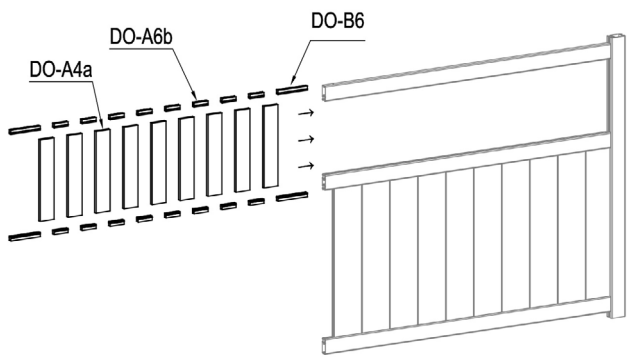

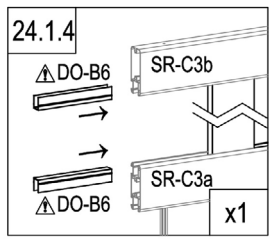

| | | | |
|--|--------|--------|----|
| | DO-A4a | 406mm | 9 |
| | DO-B6 | 163mm | 4 |
| | DO-A6b | 77.5mm | 16 |

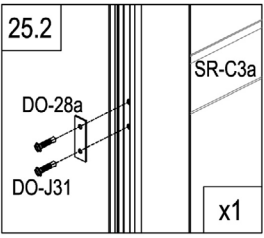
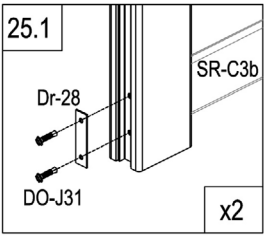
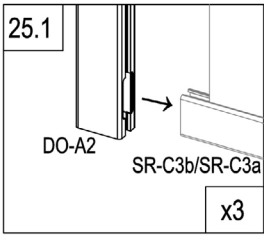
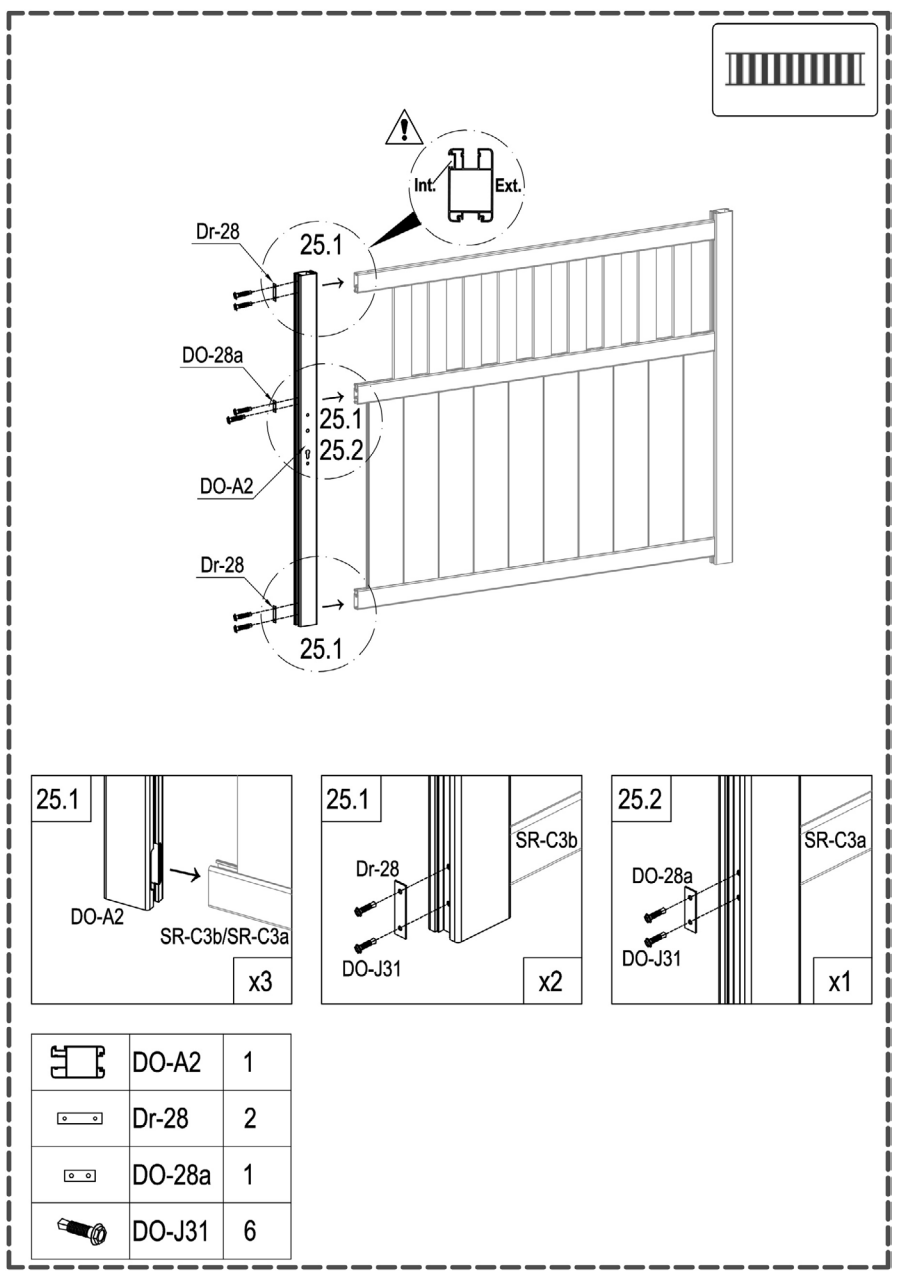

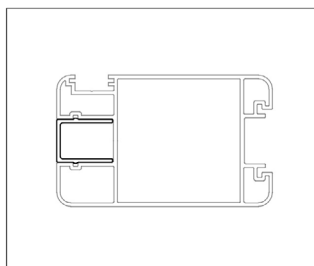
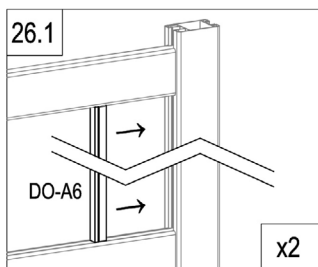
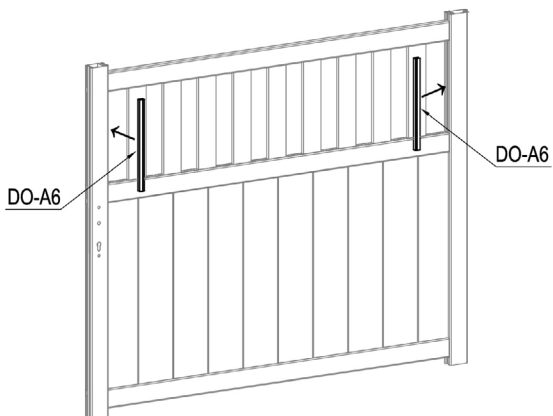

| | | |
|--|--------|---|
| | DO-A2 | 1 |
| | Dr-28 | 2 |
| | DO-28a | 1 |
| | DO-J31 | 6 |



| | | |
|---|-------|---|
|  | DO-A6 | 2 |
|---|-------|---|

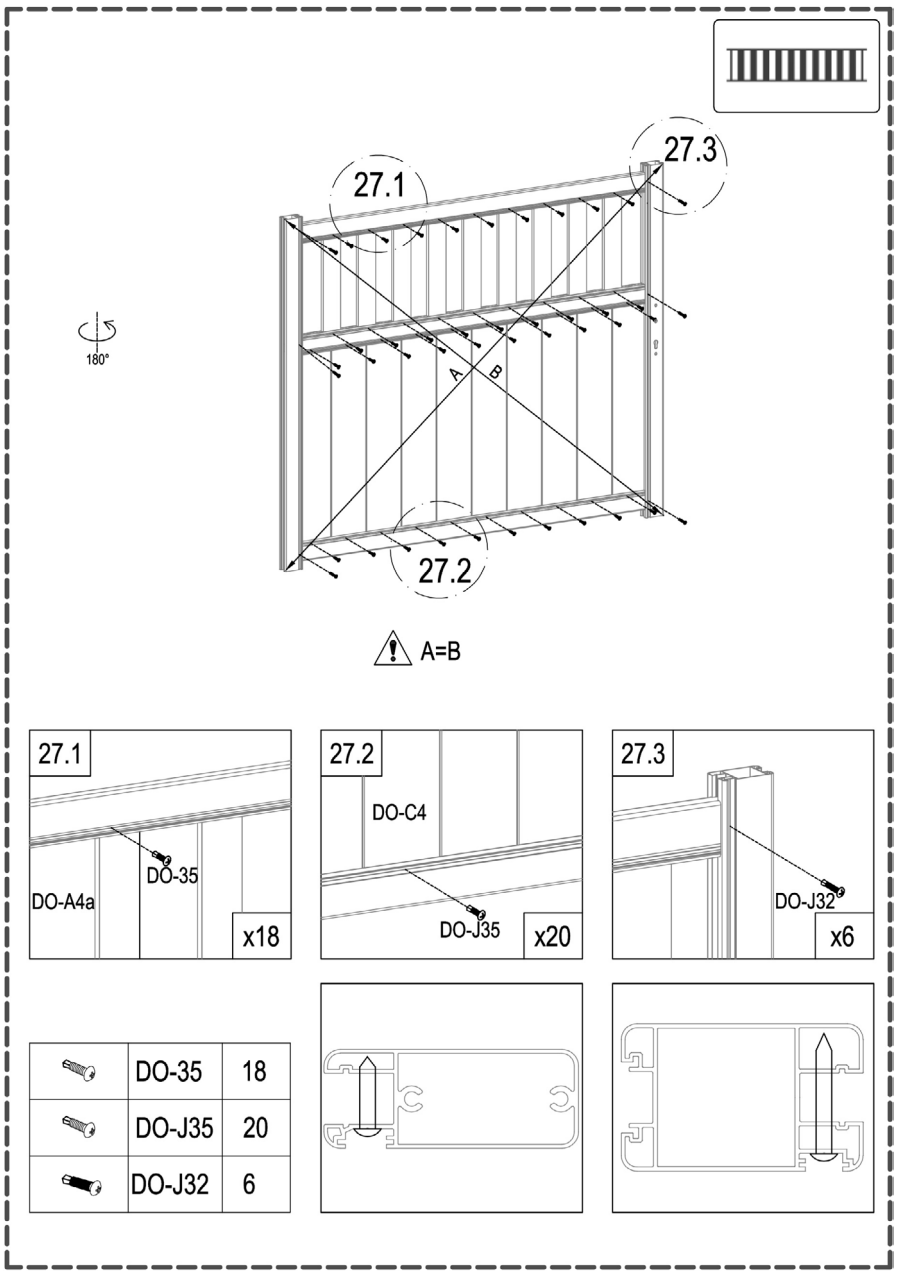

180°

! A=B

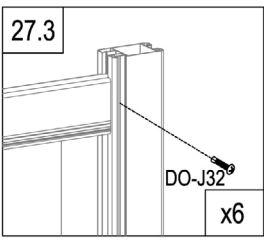
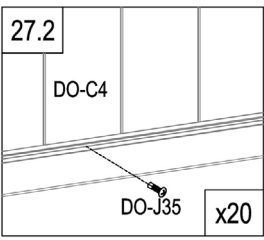
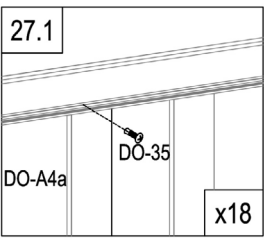

| | | |
|--|--------|----|
| | DO-35 | 18 |
| | DO-J35 | 20 |
| | DO-J32 | 6 |

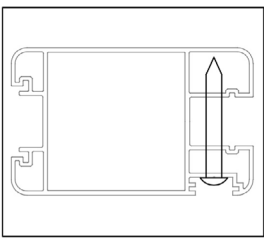
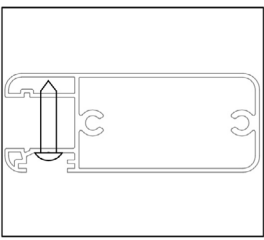

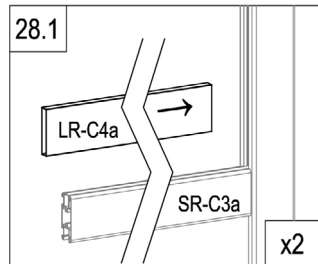
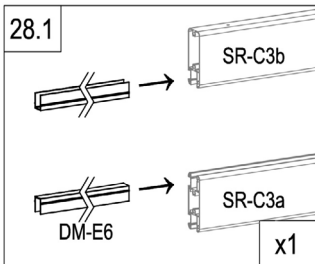
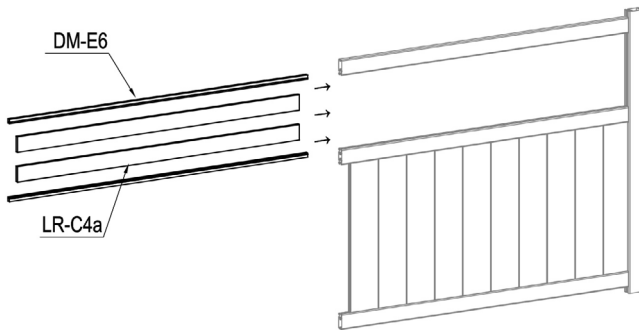

| | | |
|--|--------|---|
| | LR-C4a | 2 |
| | DM-E6 | 2 |

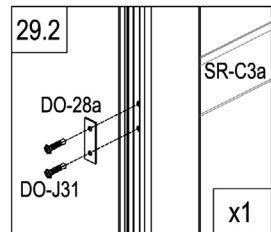
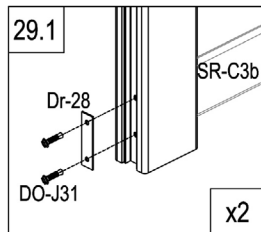
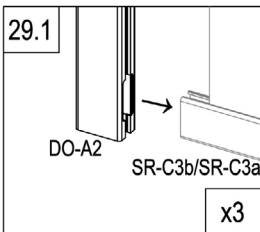
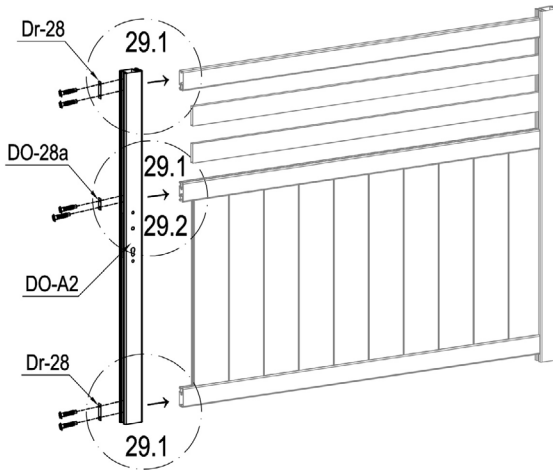

| | | |
|--|--------|---|
| | DO-A2 | 1 |
| | Dr-28 | 2 |
| | DO-28a | 1 |
| | DO-J31 | 6 |

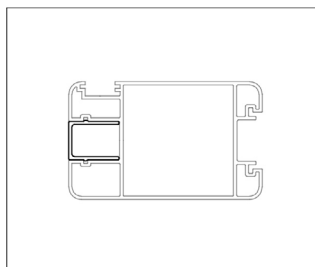
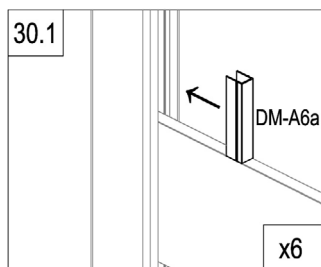
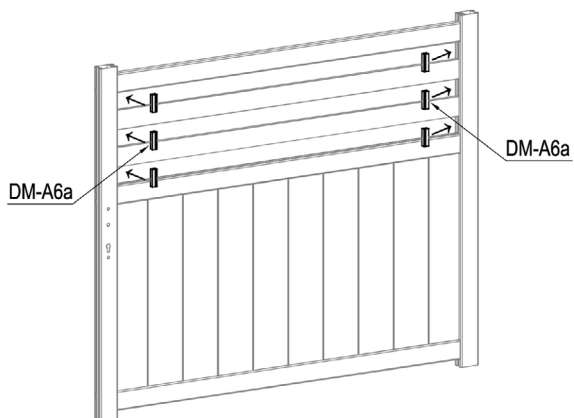

| | | |
|--|--------|---|
| | DM-A6a | 6 |
|--|--------|---|

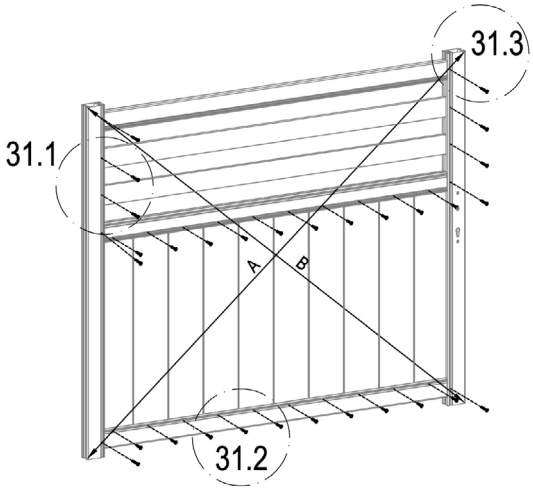
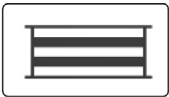

A=B

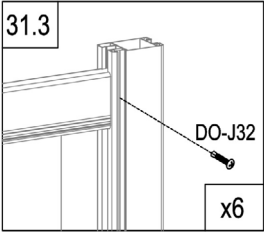
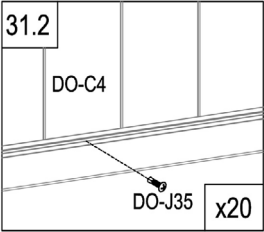
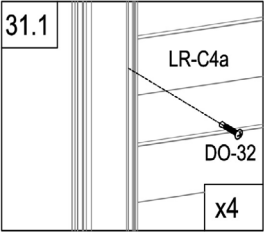

| | | |
|--|--------|----|
| | DO-32 | 4 |
| | DO-J35 | 20 |
| | DO-J32 | 6 |

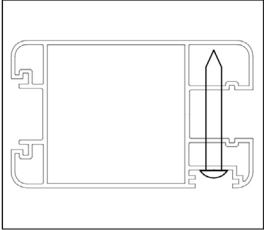
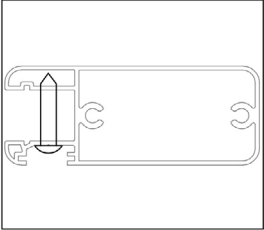

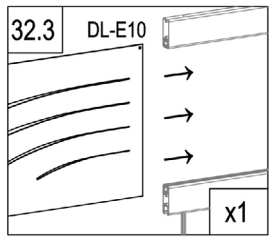
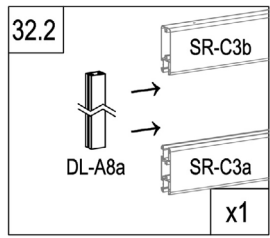
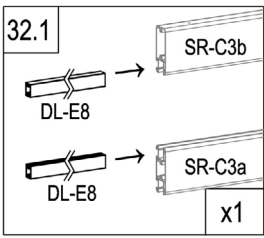
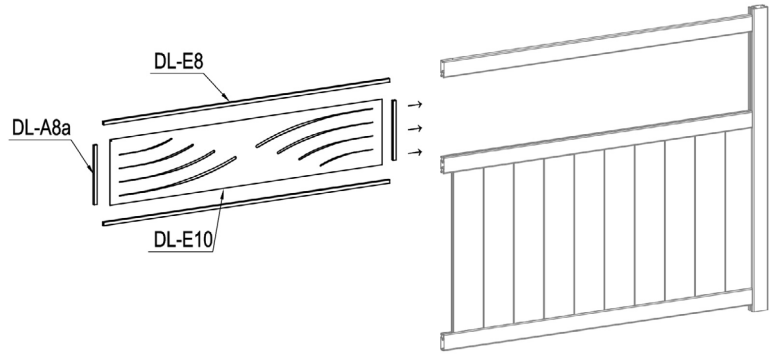



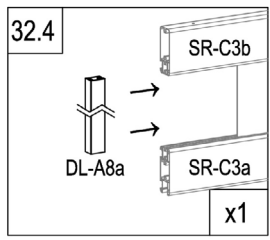

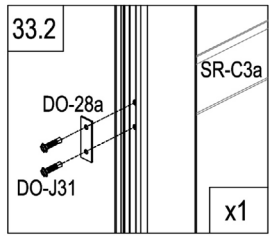
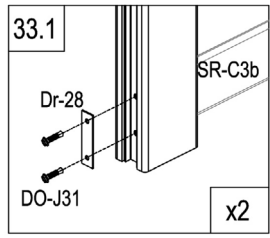
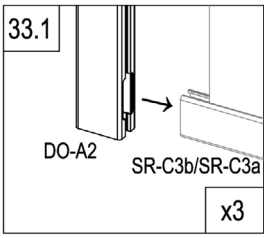
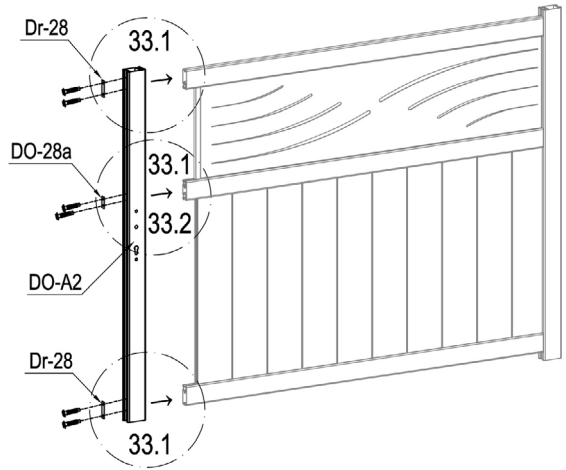
| | | |
|--|--------|---|
| | DL-E10 | 1 |
| | DL-E8 | 2 |
| | DL-A8a | 2 |



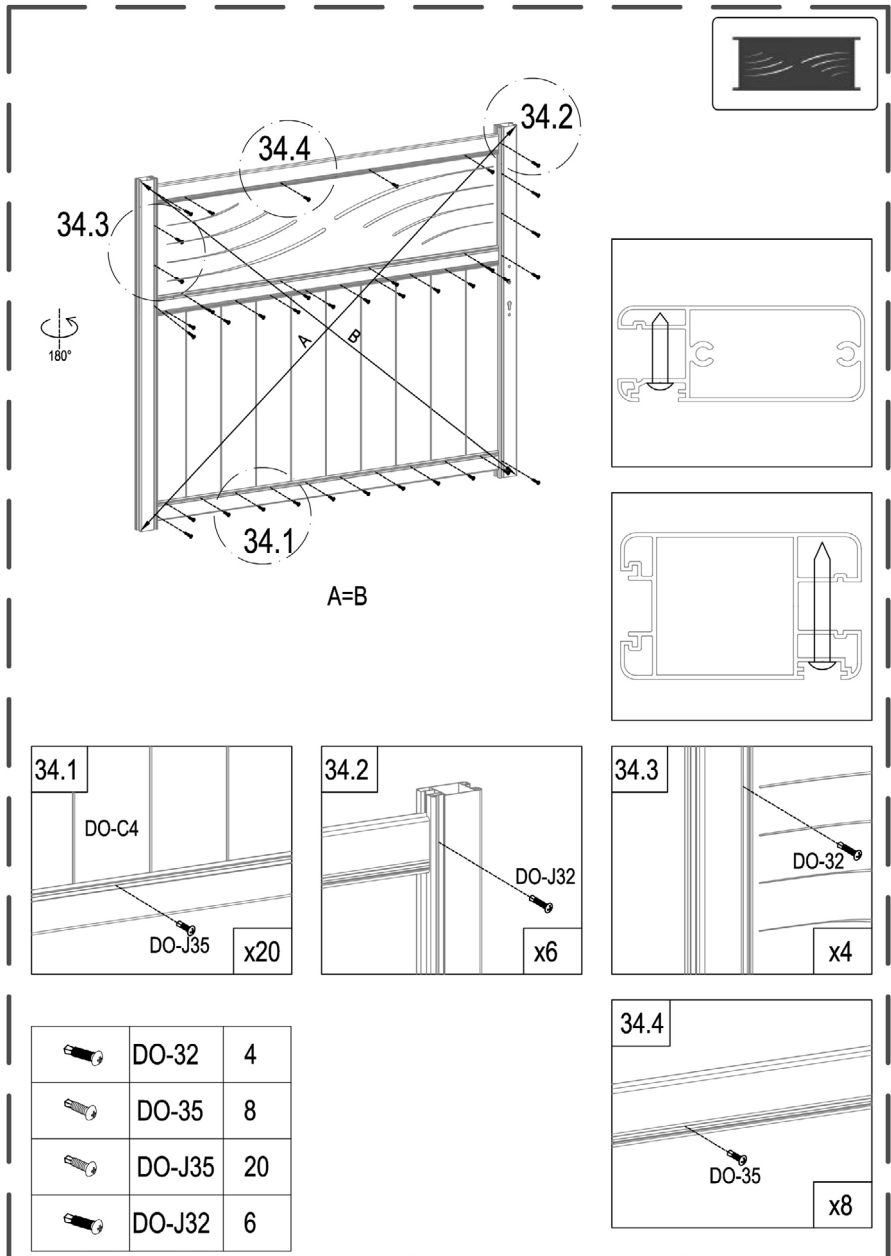



| | | |
|--|--------|---|
| | DO-A2 | 1 |
| | Dr-28 | 2 |
| | DO-28a | 1 |
| | DO-J31 | 6 |



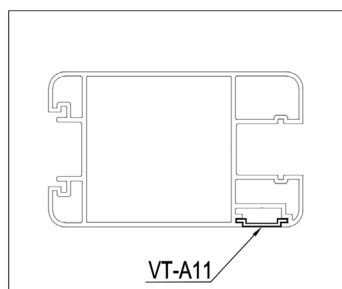
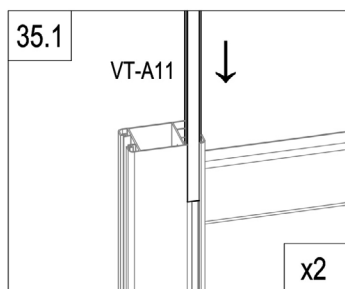
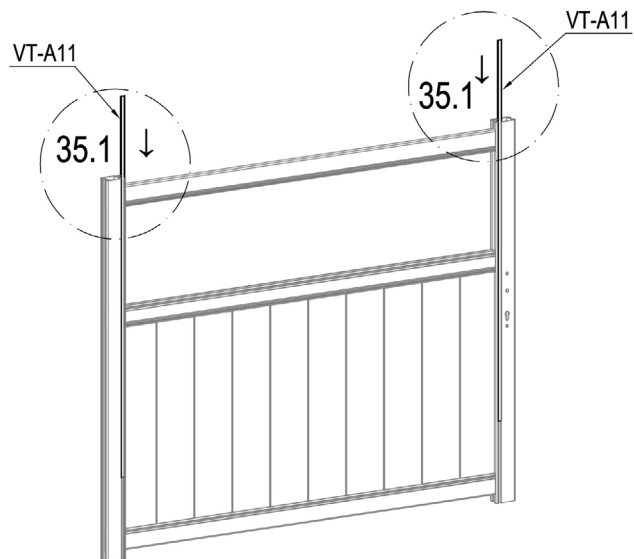

| | | |
|---|--------|----|
|  | DO-32 | 4 |
|  | DO-35 | 8 |
|  | DO-J35 | 20 |
|  | DO-J32 | 6 |

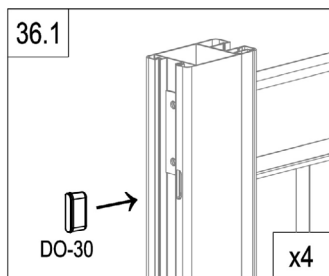
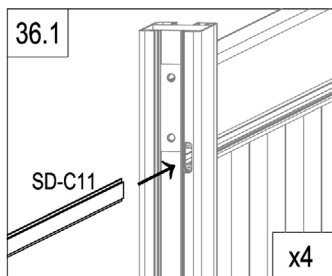
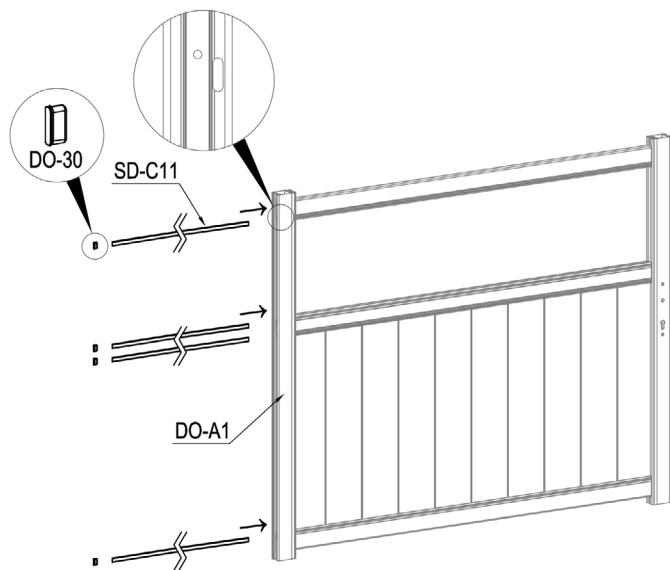

| | | |
|---|--------|---|
|  | VT-A11 | 2 |
|---|--------|---|



| | | |
|---|--------|---|
|  | SD-C11 | 4 |
|  | DO-30 | 4 |

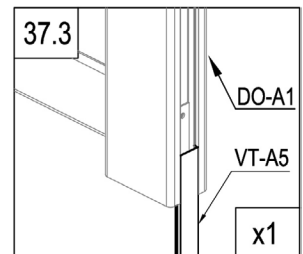
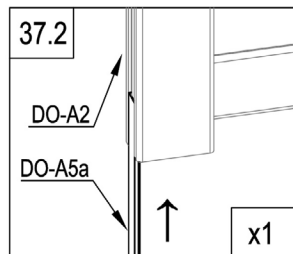
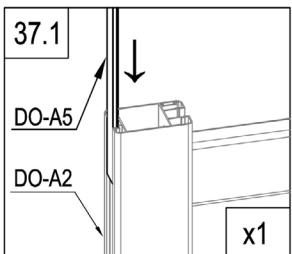
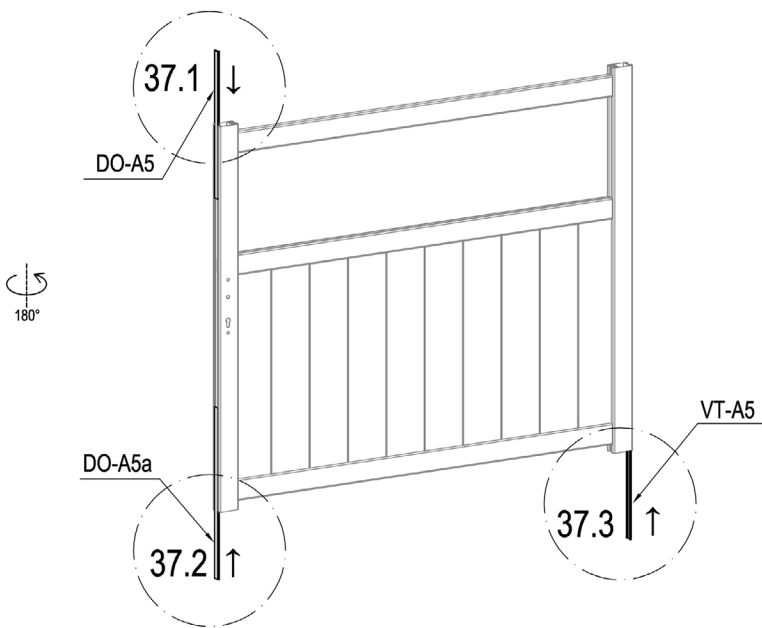

| | | |
|---|--------|---|
|  | VT-A5 | 1 |
| | DO-A5 | 1 |
| | DO-A5a | 1 |

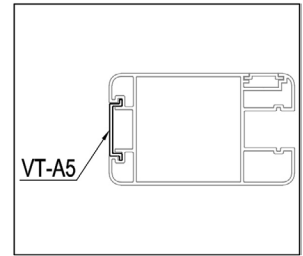

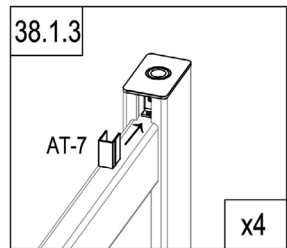
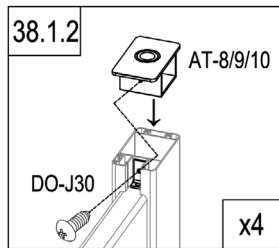
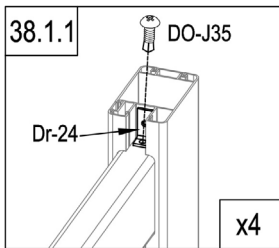
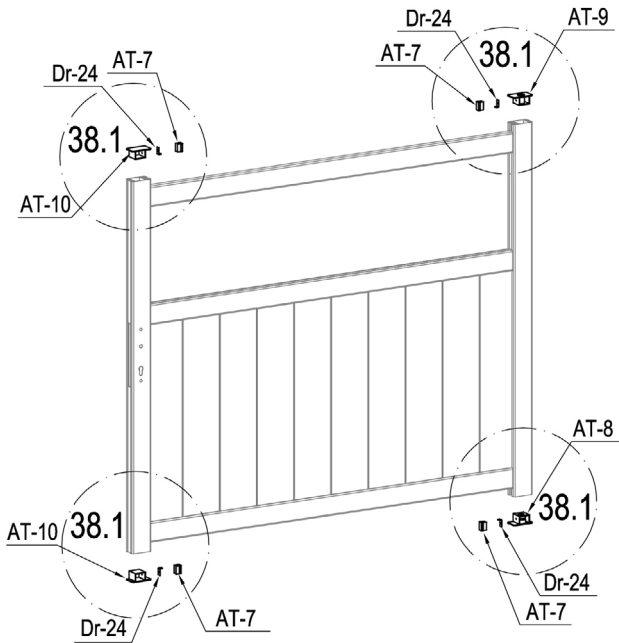

| | | |
|--|-------|---|
| | AT-8 | 1 |
| | AT-9 | 1 |
| | AT-10 | 2 |
| | Dr-24 | 4 |

| | | |
|--|--------|---|
| | AT-7 | 4 |
| | DO-J30 | 4 |
| | DO-J35 | 4 |

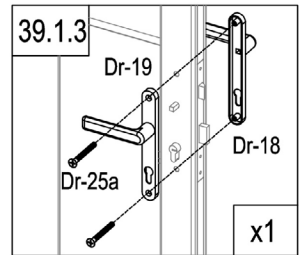
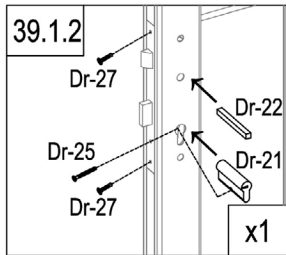
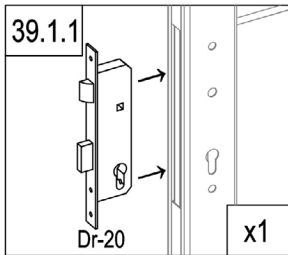
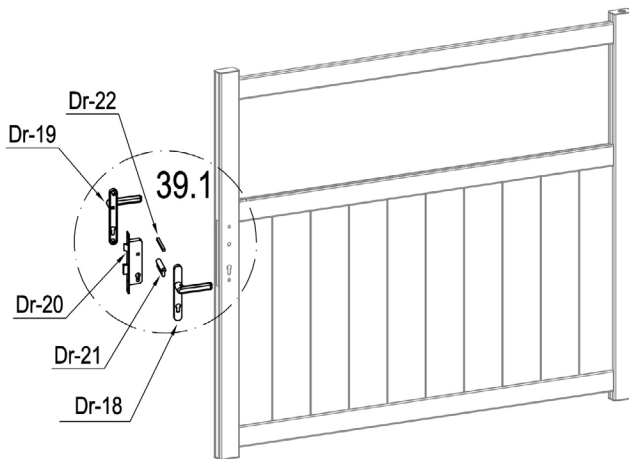

| | | |
|--|-------|---|
| | Dr-20 | 1 |
| | Dr-21 | 1 |
| | Dr-22 | 1 |
| | Dr-25 | 1 |

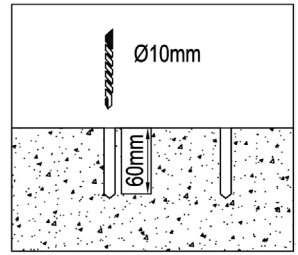
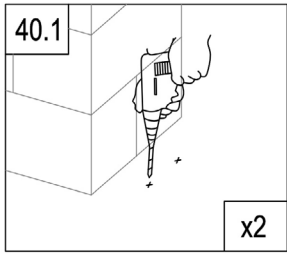
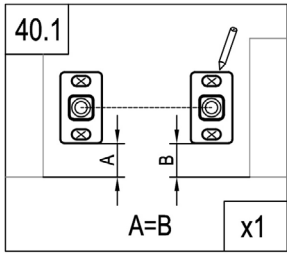
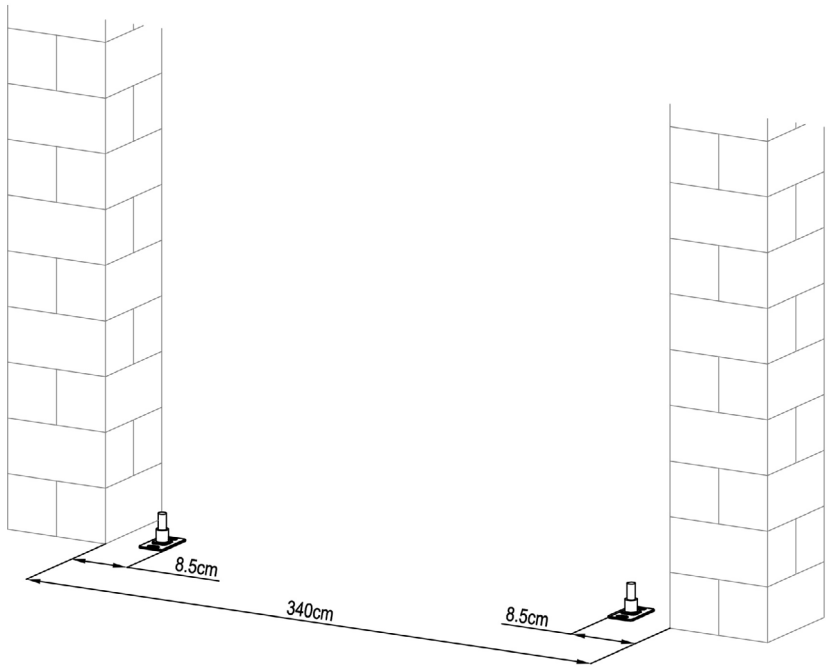

| | | |
|--|--------|---|
| | Dr-18 | 1 |
| | Dr-19 | 1 |
| | Dr-25a | 2 |
| | Dr-27 | 2 |

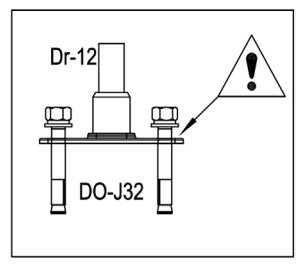
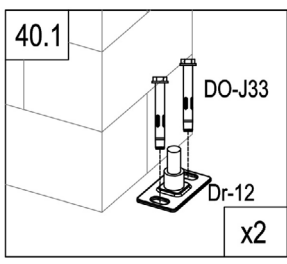

| | | |
|--|--------|---|
| | Dr-12 | 2 |
| | DO-J33 | 4 |

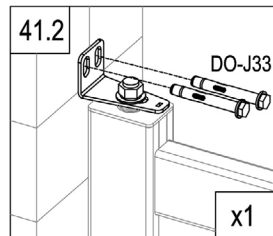
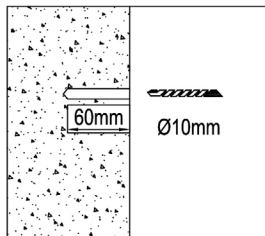
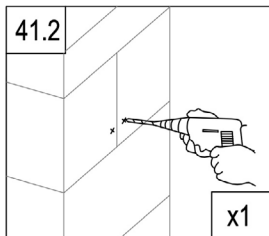
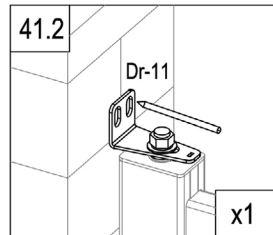
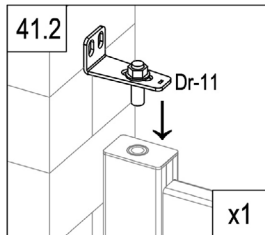
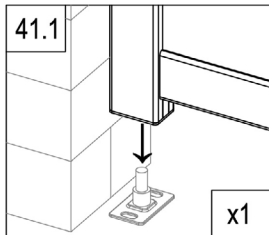
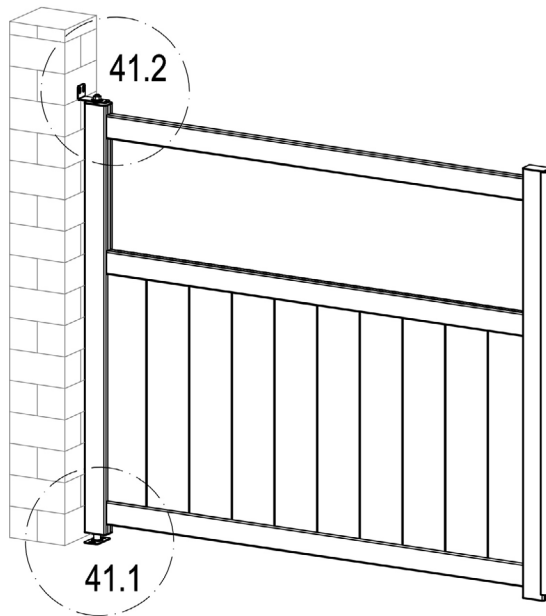





| | | |
|---|--------|---|
|  | Dr-11 | 1 |
|  | DO-J33 | 2 |

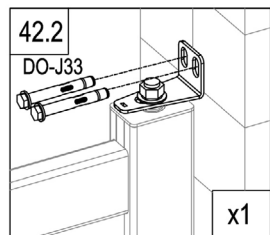
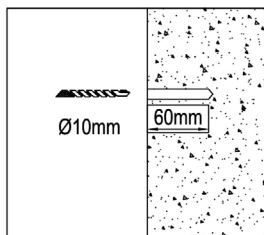
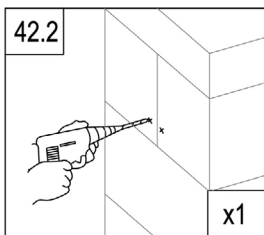
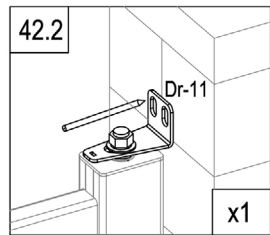
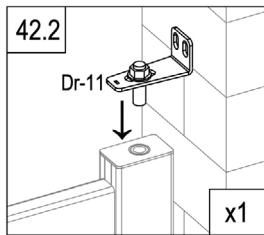
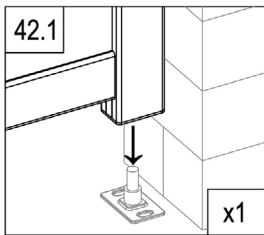
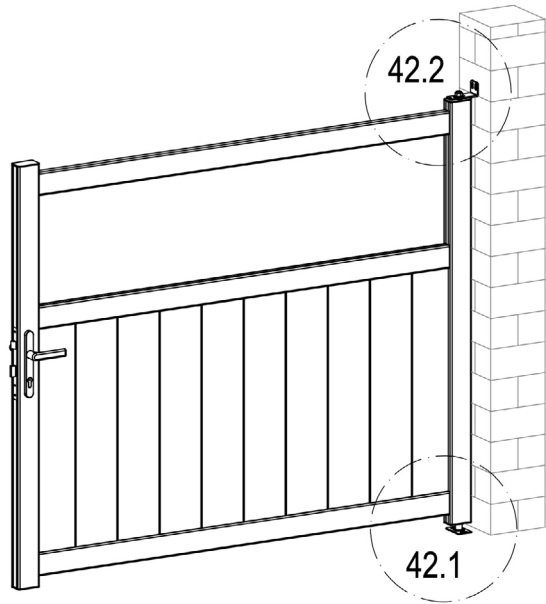

CASANOVO



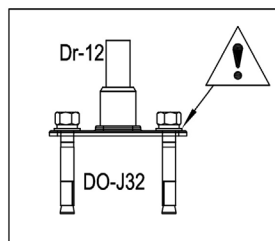
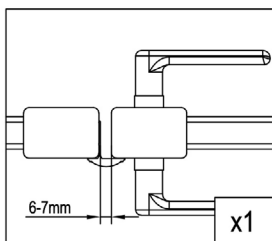
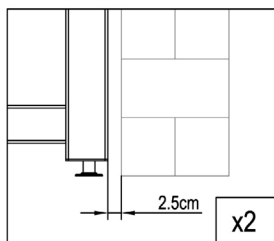
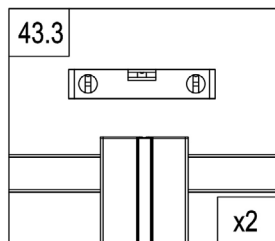
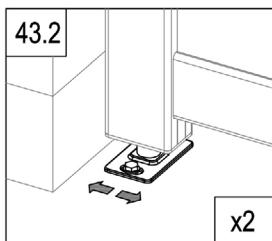
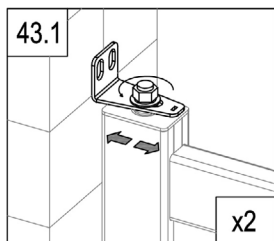
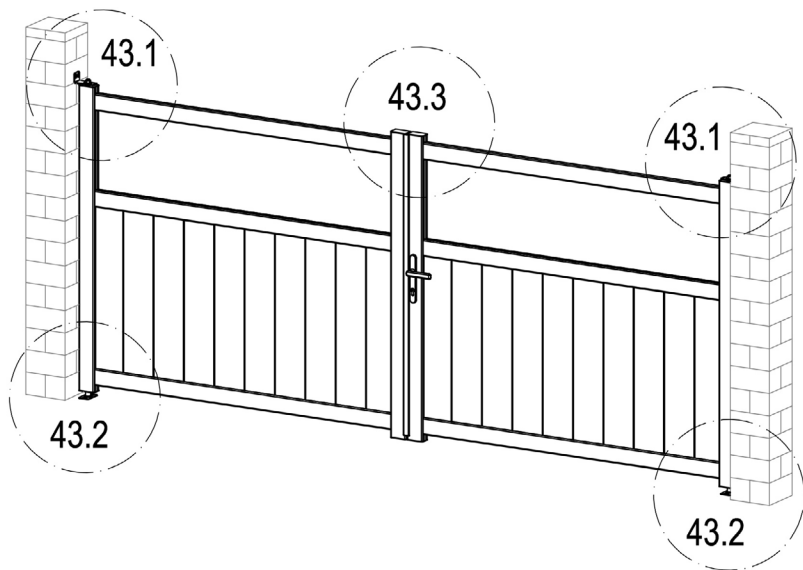
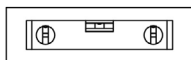

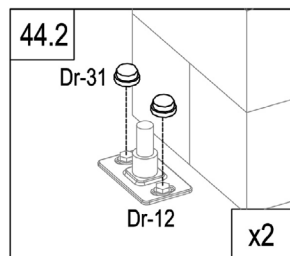
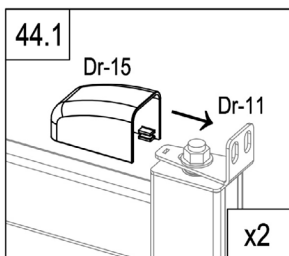
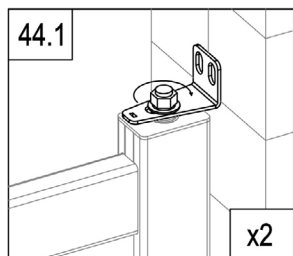
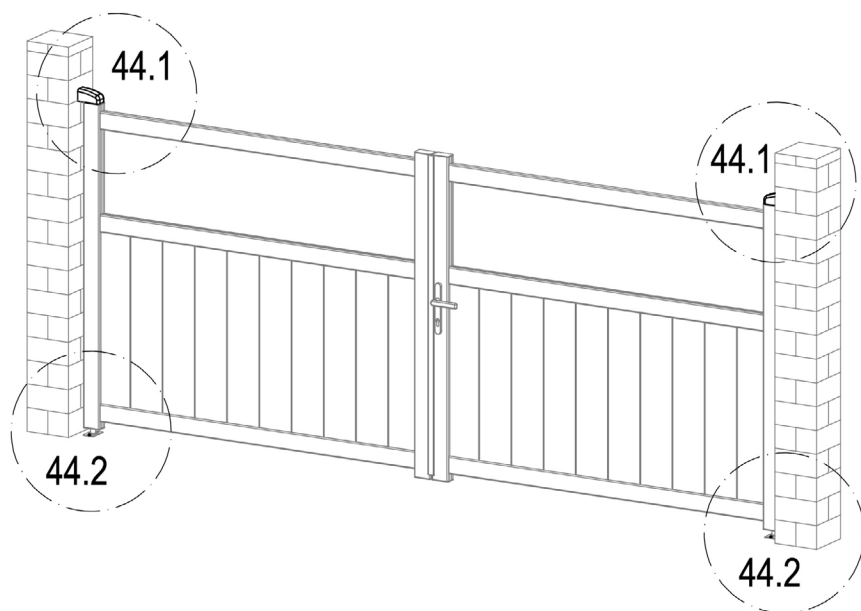

| | | |
|---|--------|---|
|  | Dr-11 | 1 |
|  | DO-J33 | 2 |



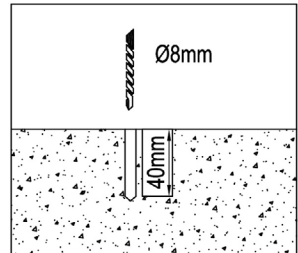
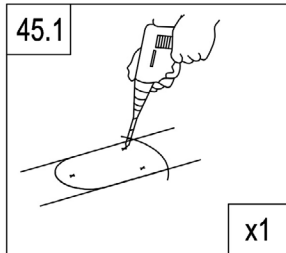
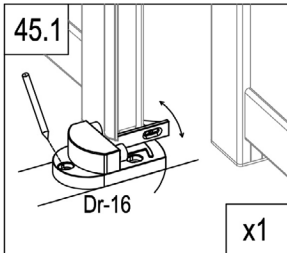
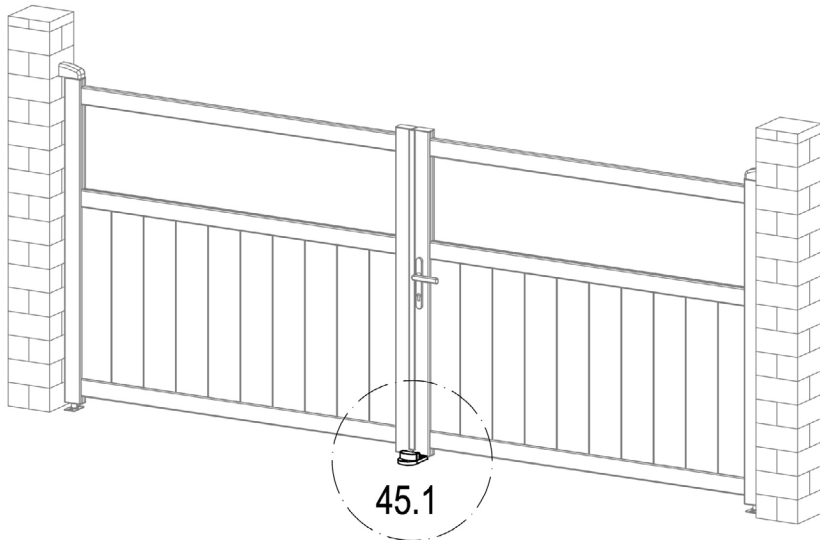

| | | |
|---|-------|---|
|  | Dr-15 | 2 |
|  | Dr-31 | 4 |



| | | |
|---|--------|---|
|  | Dr-16 | 1 |
|  | DO-J34 | 3 |
|  | DO-J36 | 3 |

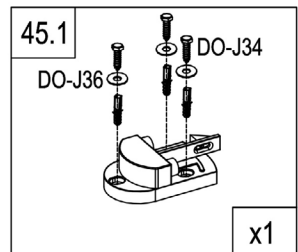

CASANOVO

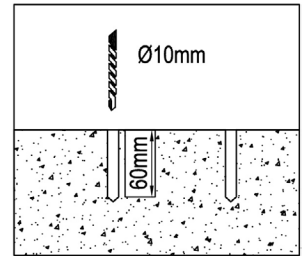
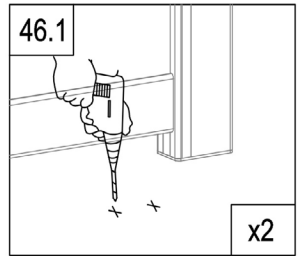
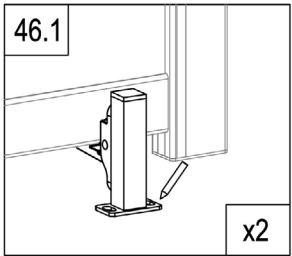
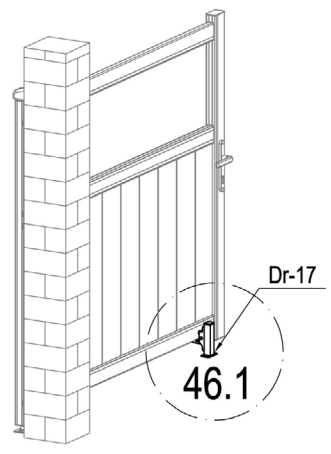
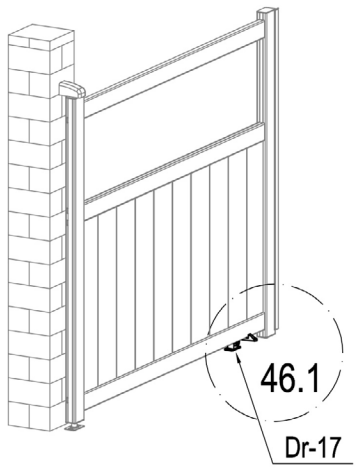

| | | |
|--|--------|---|
| | DO-J33 | 4 |
| | Dr-17 | 2 |

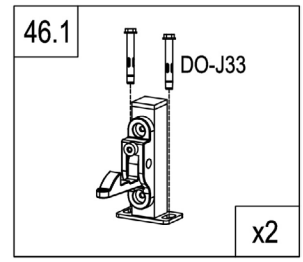

CASANOVO

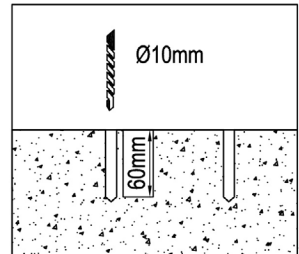
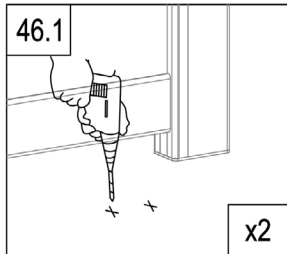
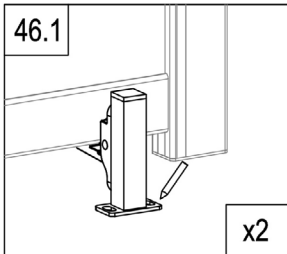
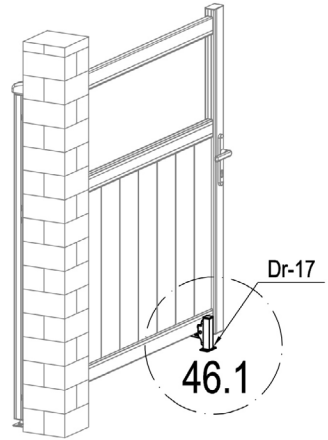
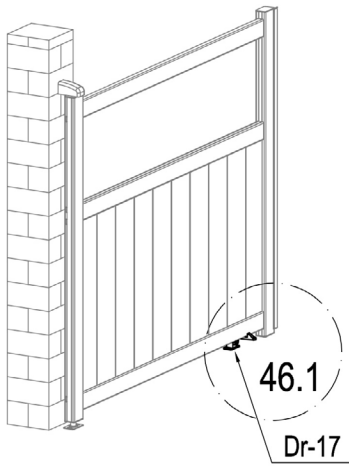

| | | |
|--|--------|---|
| | DO-J33 | 4 |
| | Dr-17 | 2 |

