

CASANOVO

CIMONE 300C160

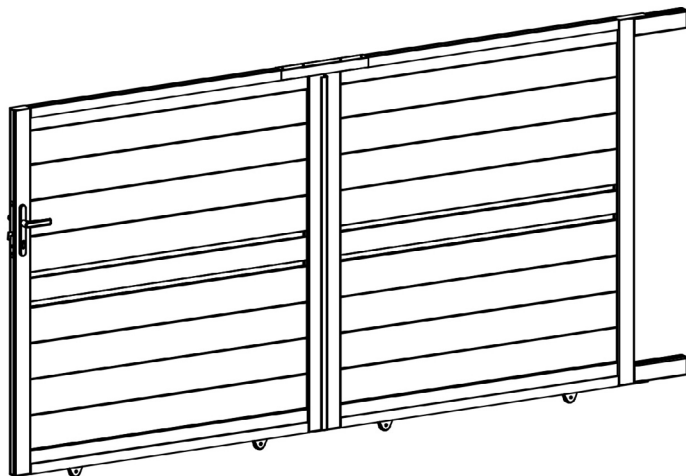

COM-001196 [x1]

COM-001197 [x1]

COM-001198 [x1]



INSTRUCTION MANUAL / NOTICE DE MONTAGE / MONTAGEANLEITUNG / MANUAL DE MONTAJE / MANUAL DE MONTAGEM / MANUALE DI MONTAGGIO /
MONTAGEHANDLEIDING / INSTRUKCJA MONTAŻU / KÄYTTÖOHJEET / BRUGSANVISNING / BRUGSANVISNING / INSTRUCȚIUNI DE ASAMBLARE /
NAVODILA ZA SESTAVLJANJE / NÁVOD NA MONTÁŽ / ÖSSZESZERELÉSI ÚTMUTATÓ / NÁVOD K MONTÁŽI / UPUTE ZA INSTALACIJU /
ΟΔΗΓΙΕΣ ΣΥΝΑΡΜΟΛΟΓΗΣΗΣ / SURINKIMO INSTRUKCIJOS / MONTĀŽAS INSTRUKCIJAS

Ext.

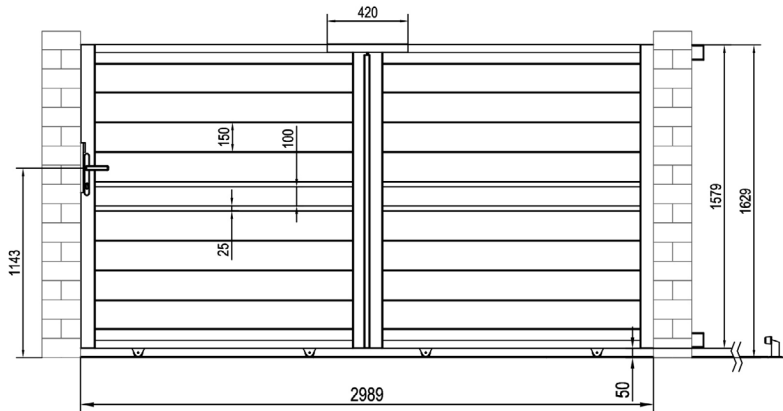

Int.

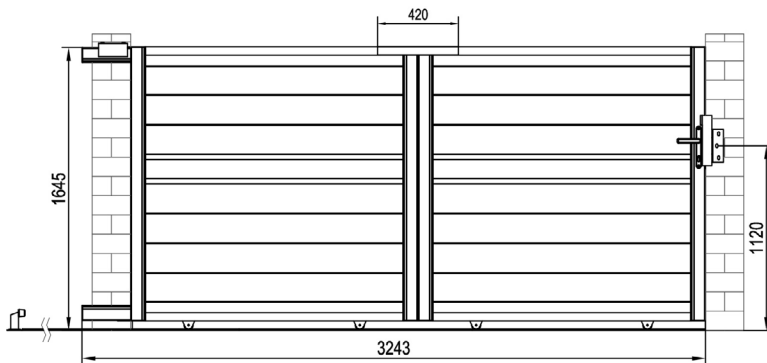

CASANOVO

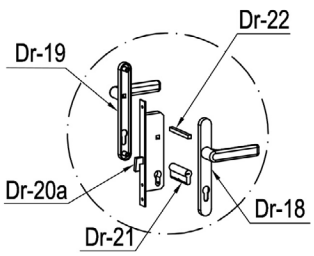
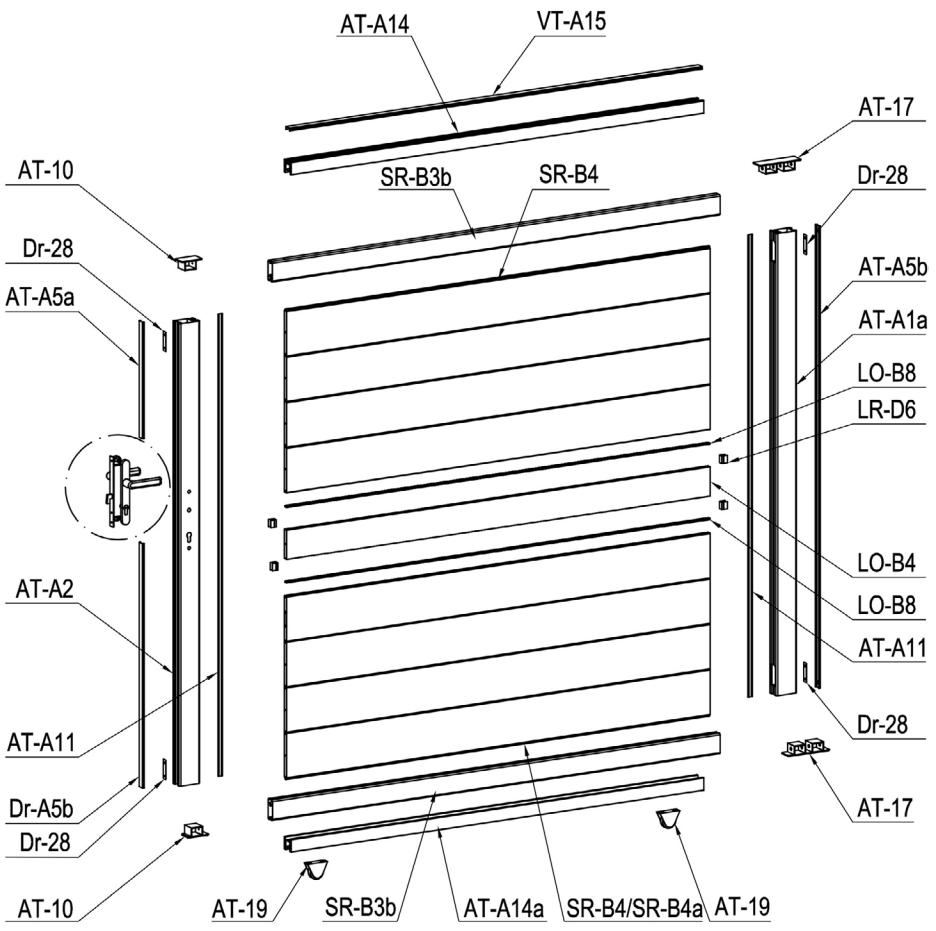



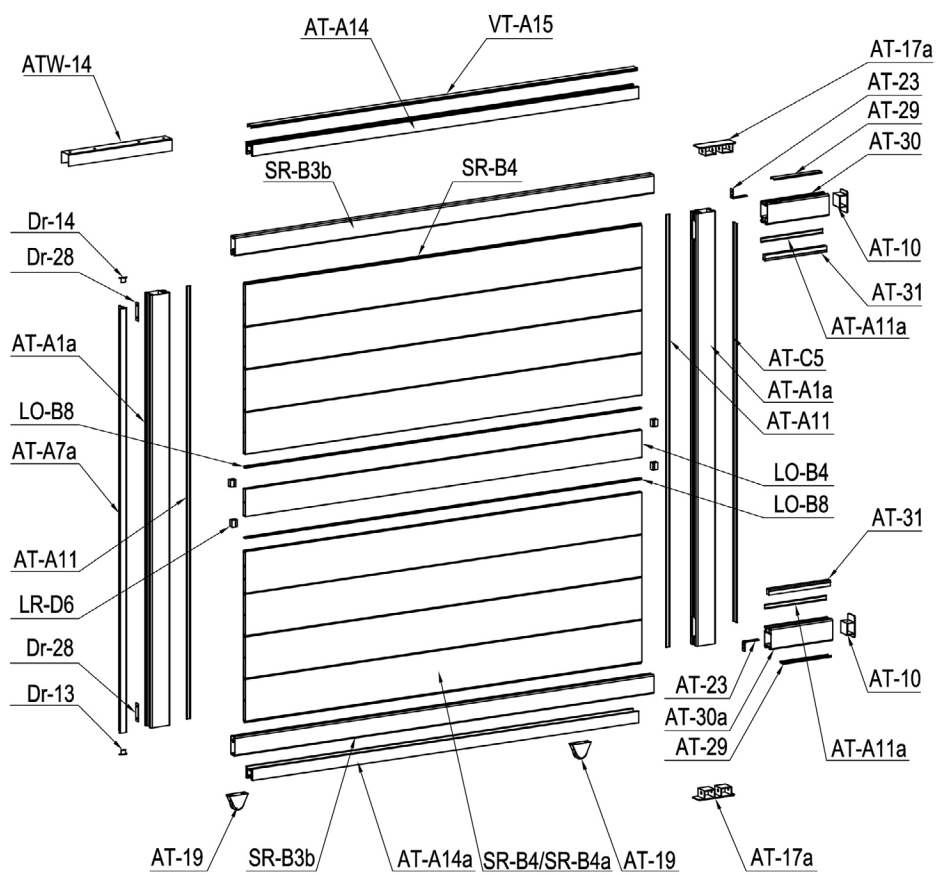

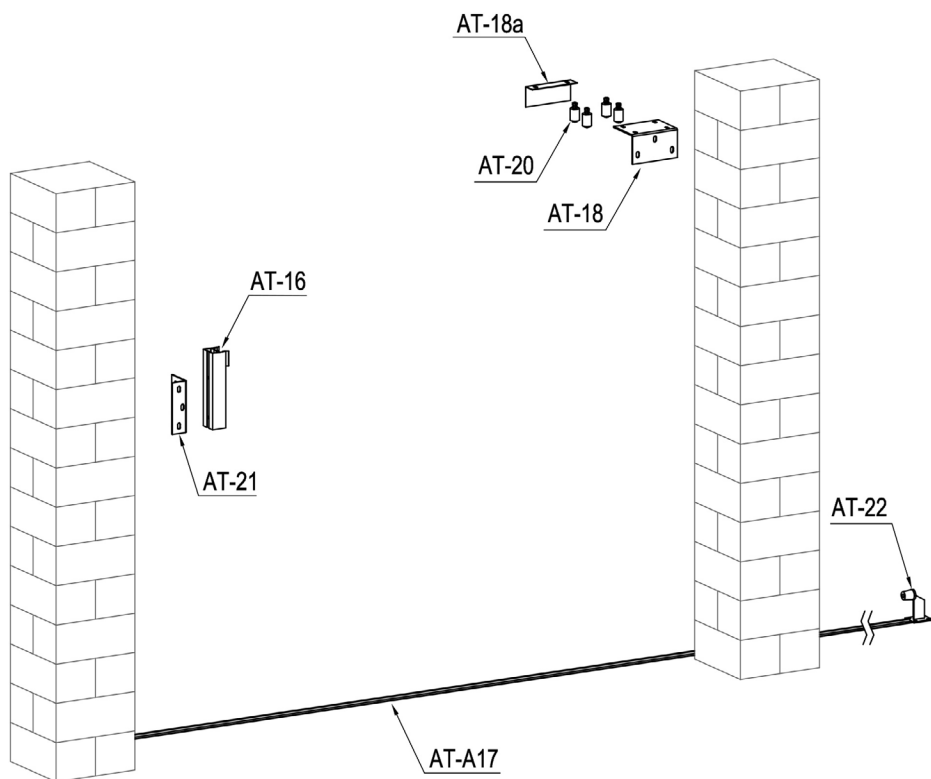









































CASANOVO







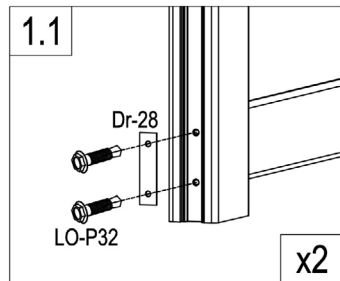
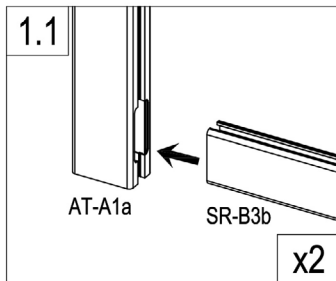
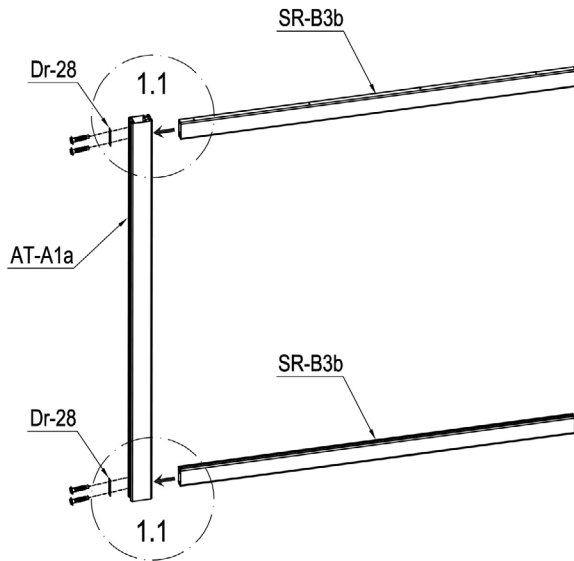

CASANOVO

| IMAGE | NO. | L.(mm) | QTY | IMAGE | NO. | L.(mm) | QTY |
|---|---------|--------|-----|---|--------|----------|-----|
|  | AT-A1a | 1573 | 3 |  | Dr-14 | | 1 |
| | AT-A2 | 1573 | 1 |  | AT-18 | | 1 |
| | AT-30 | 250 | 1 |  | AT-18a | | 1 |
| | AT-30a | 250 | 1 |  | ATW-14 | 420 | 1 |
|  | SR-B3b | 1471 | 4 |  | AT-19 | | 4 |
|  | SR-B4a | 1380 | 2 |  | AT-20 | | 4 |
|  | SR-B4 | 1380 | 14 |  | AT-21 | | 1 |
|  | LO-B4 | 1380 | 2 |  | AT-22 | | 1 |
|  | AT-A5b | 1573 | 1 |  | AT-23 | | 2 |
| | AT-C5 | 1448 | 1 |  | Dr-18 | | 1 |
| | AT-A5a | 395.5 | 1 |  | Dr-19 | | 1 |
| | Dr-A5b | 937 | 1 |  | Dr-20a | | 1 |
| | AT-29 | 193 | 2 |  | Dr-21 | | 1 |
|  | AT-A11 | 1573 | 4 |  | Dr-22 | | 1 |
| | AT-A11a | 250 | 2 |  | Dr-25 | | 1 |
|  | AT-31 | 250 | 2 |  | Dr-25a | | 2 |
| | LR-D6 | 25 | 8 |  | Dr-27 | | 2 |
|  | LO-B8 | 1379 | 4 |  | Dr-28 | | 6 |
|  | AT-A7a | 1520 | 1 |  | AT-22J | | 7 |
|  | AT-A14 | 1338 | 2 |  | LO-P30 | ST4x10 | 4 |
| | AT-A14a | 1338 | 2 |  | LO-P31 | M8x60 | 10 |
|  | VT-A15 | 1337 | 2 |  | LO-P32 | ST5.5x38 | 28 |
|  | AT-16 | 260 | 1 |  | LO-P33 | M8x130 | 4 |
|  | AT-A17 | 1212 | 5 |  | LO-P34 | ST4.8x38 | 72 |
|  | AT-17 | | 2 |  | LO-P35 | ST4.2x19 | 6 |
|  | AT-17a | | 2 |  | LO-P36 | M6x20 | 2 |
|  | AT-10 | | 4 |  | LO-P37 | M8x20 | 8 |
|  | Dr-13 | | 1 |  | LO-P38 | ST4x25 | 40 |

CASANOVO



| | | |
|---|--------|---|
|  | AT-A1a | 1 |
|  | SR-B3b | 2 |
|  | Dr-28 | 2 |
|  | LO-P32 | 4 |

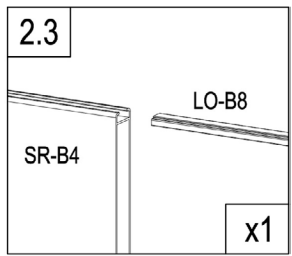
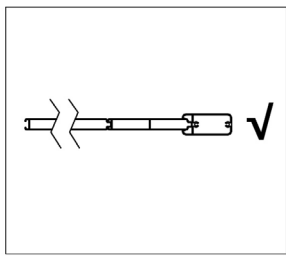
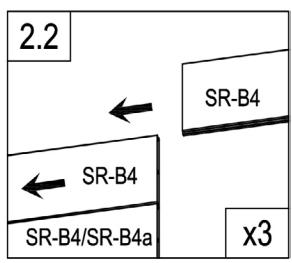
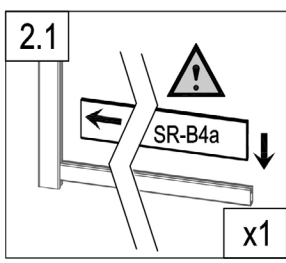
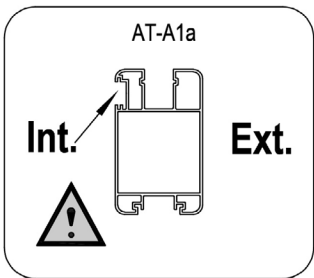
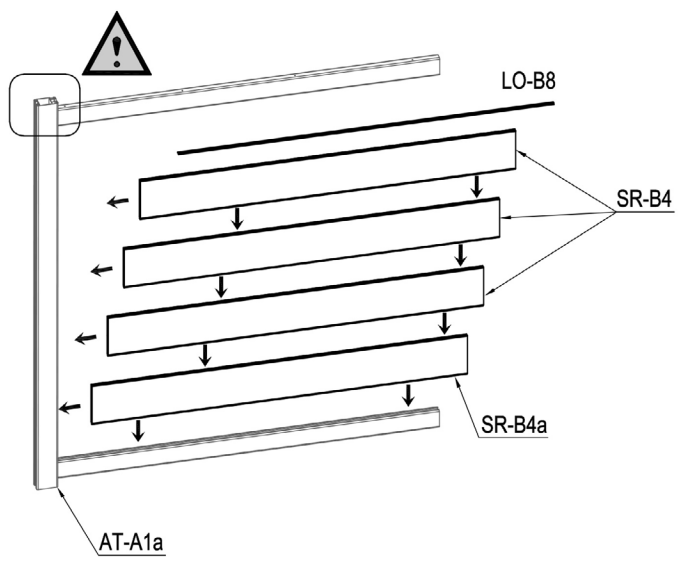

| | | |
|--|--------|---|
| | LO-B8 | 1 |
| | SR-B4 | 3 |
| | SR-B4a | 1 |

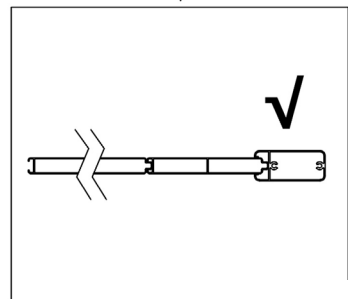
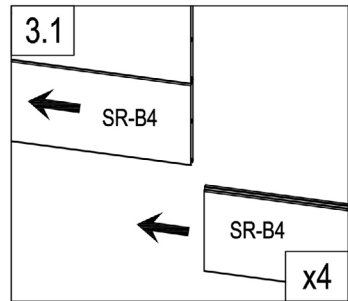
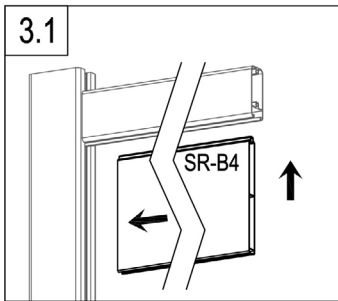
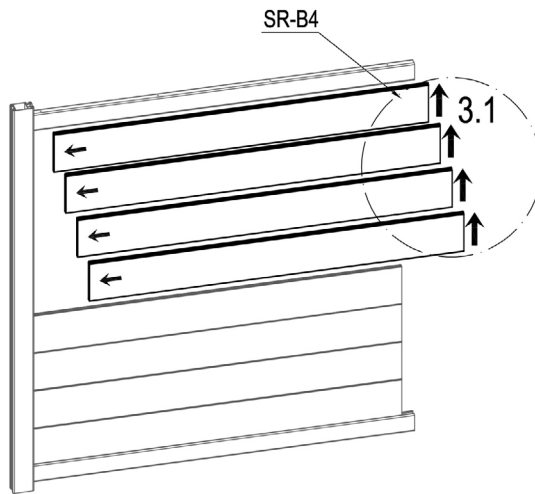

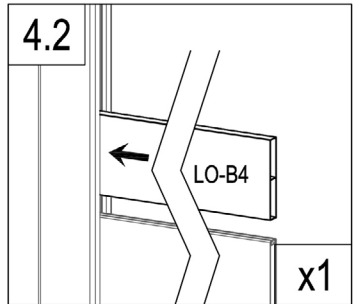
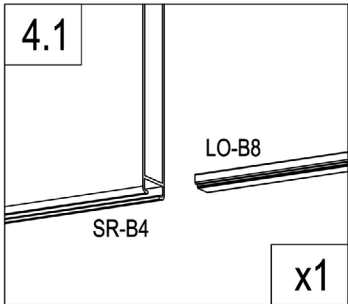
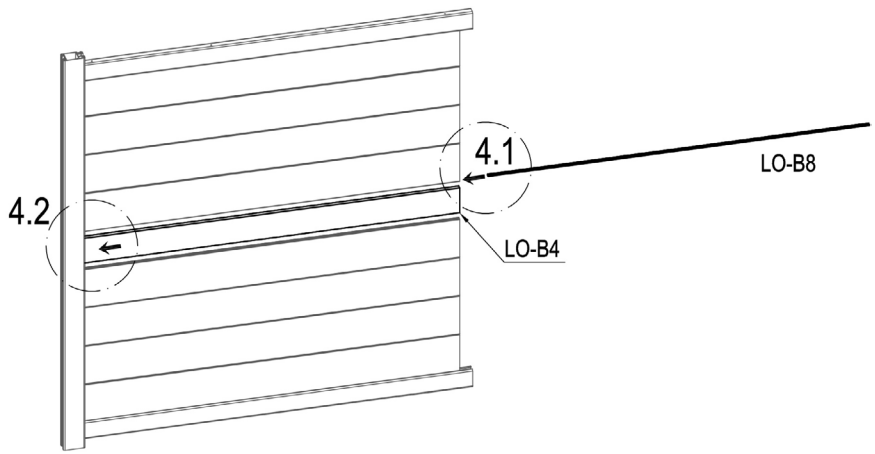

| | | |
|---|-------|---|
|  | SR-B4 | 4 |
|---|-------|---|

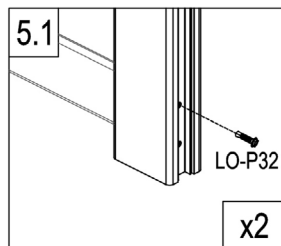
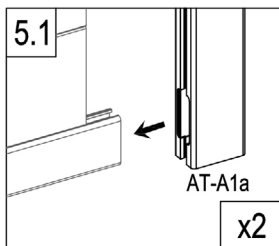
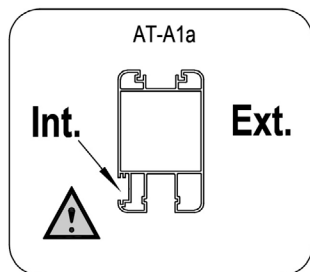
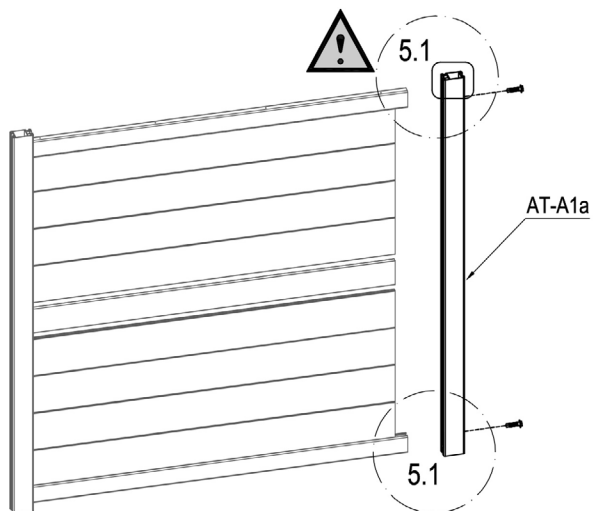

| | | |
|---|-------|---|
|  | LO-B4 | 1 |
|  | LO-B8 | 1 |



| | | |
|---|--------|---|
|  | AT-A1a | 1 |
|  | LO-P32 | 2 |

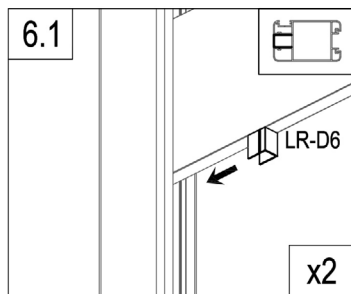
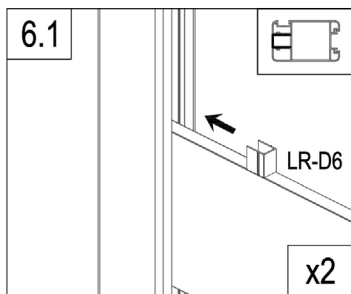
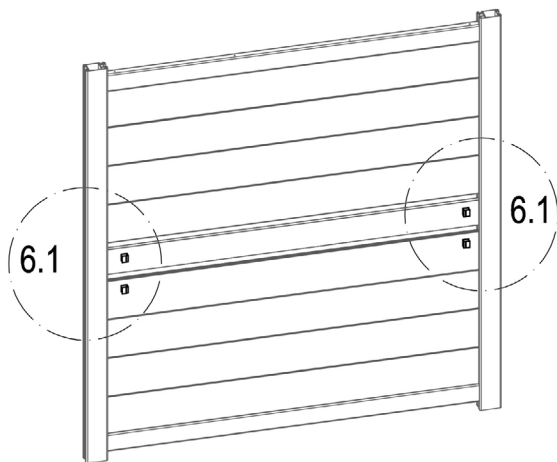

| | | |
|---|-------|---|
|  | LR-D6 | 4 |
|---|-------|---|

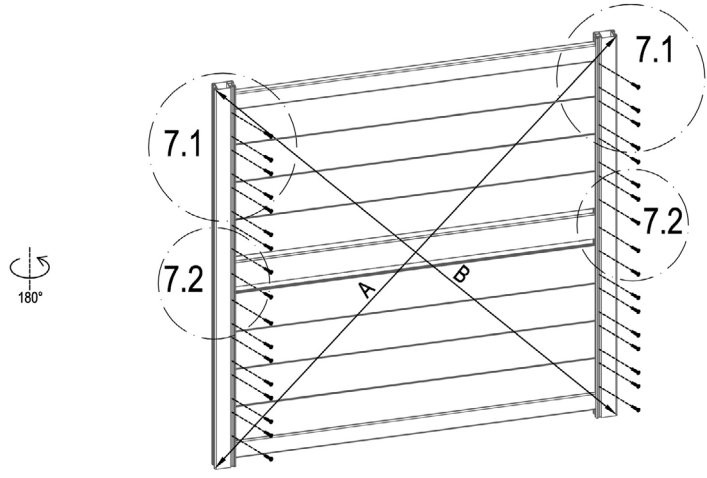

A=B

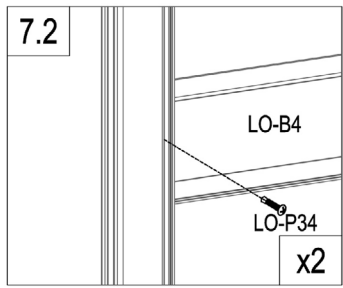
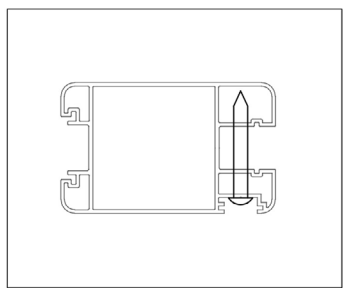
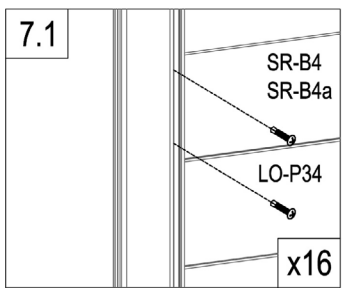



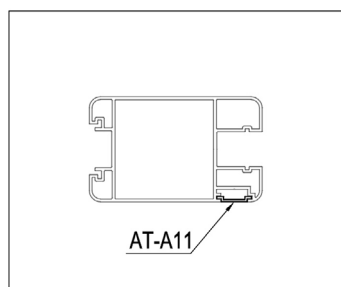
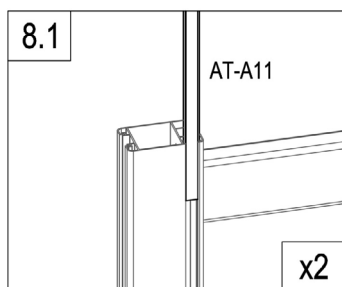
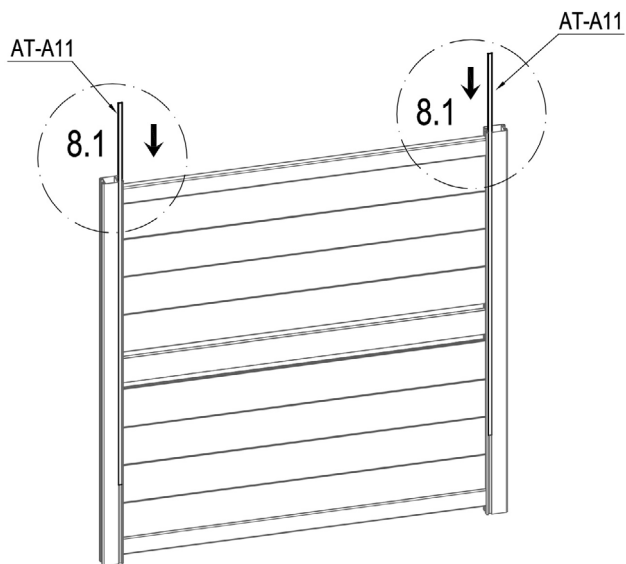

| | | |
|---|--------|----|
|  | LO-P34 | 34 |
|---|--------|----|

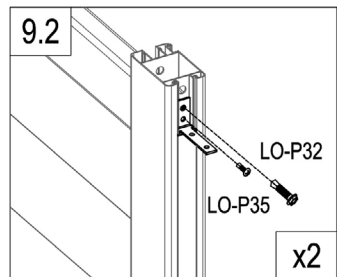
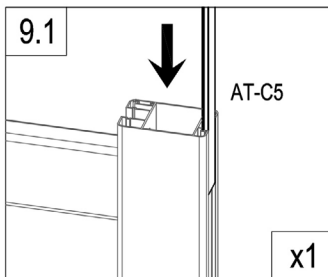
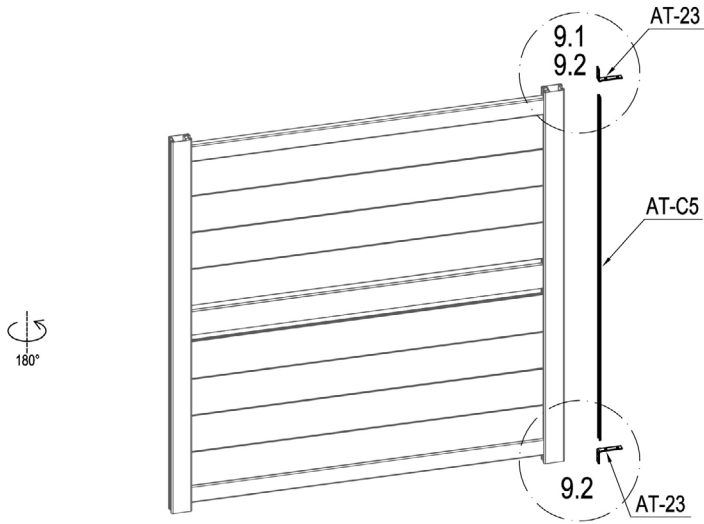

| | | |
|---|--------|---|
|  | AT-A11 | 2 |
|---|--------|---|





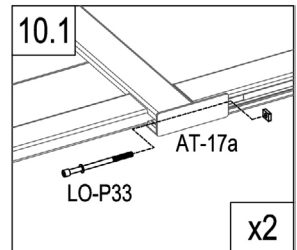
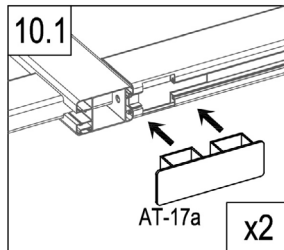
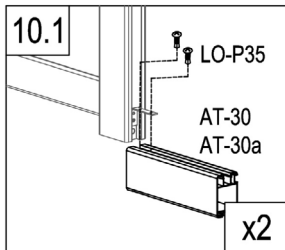
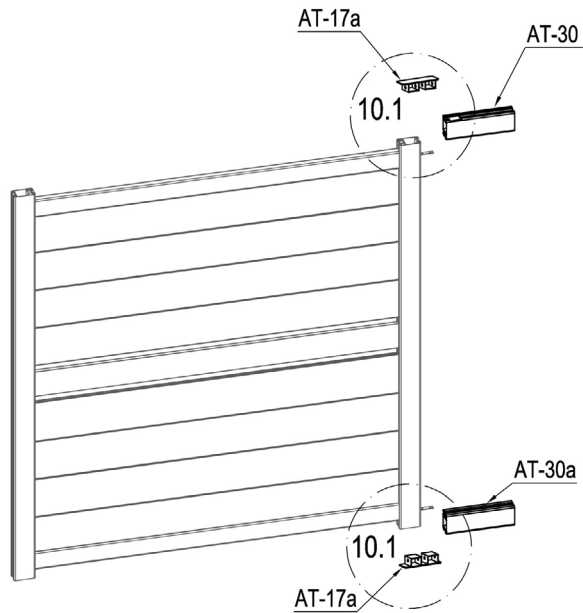

| | | |
|---|--------|---|
|  | AT-C5 | 1 |
|  | AT-23 | 2 |
|  | LO-P32 | 2 |
|  | LO-P35 | 2 |



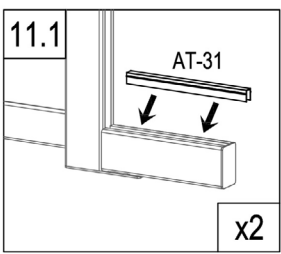
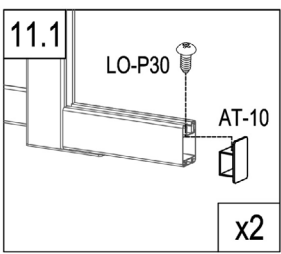
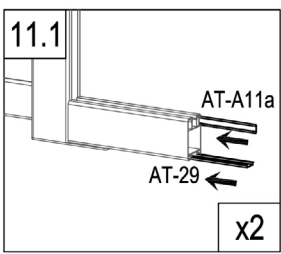
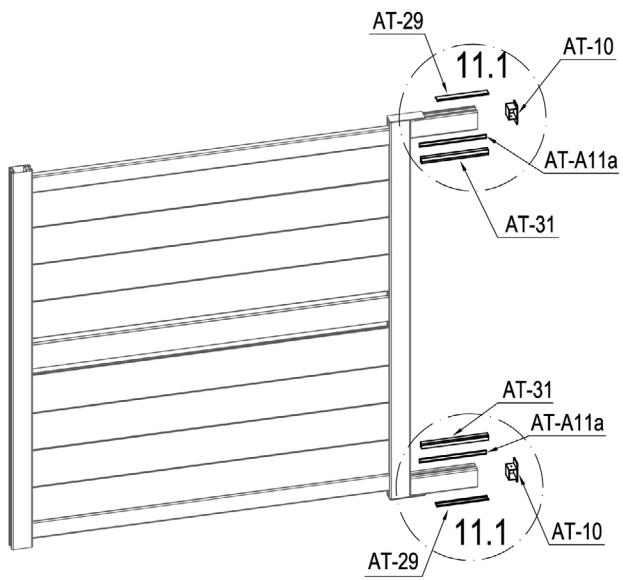

| | | |
|--|--------|---|
| | AT-30 | 1 |
| | AT-30a | 1 |
| | AT-17a | 2 |



| | | |
|--|--------|---|
| | LO-P33 | 2 |
| | LO-P35 | 4 |





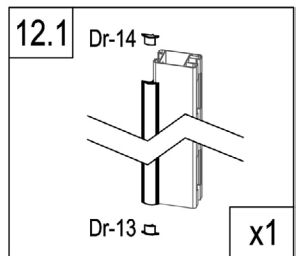
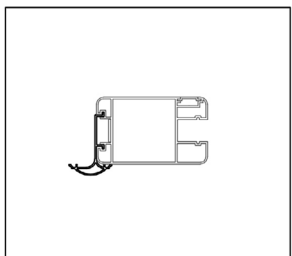
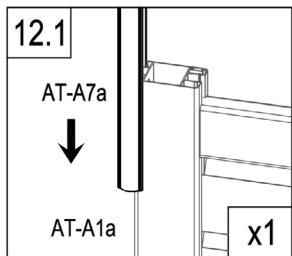
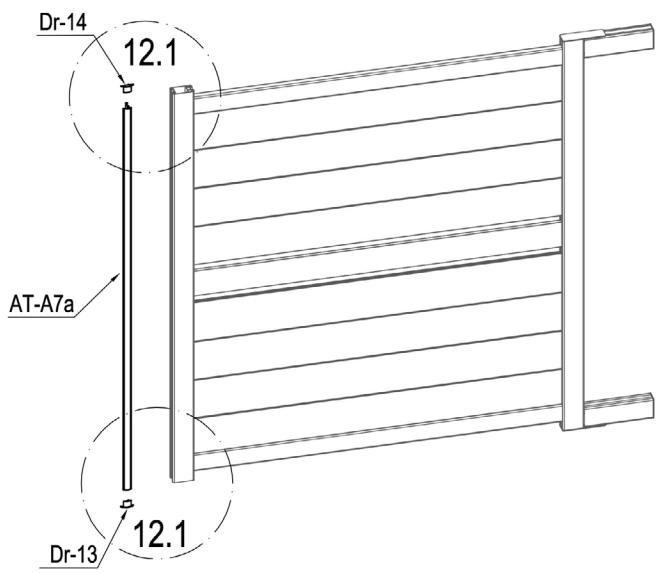

| | | |
|---|---------|---|
|  | AT-29 | 2 |
|  | AT-A11a | 2 |
|  | AT-31 | 2 |

| | | |
|---|--------|---|
|  | AT-10 | 2 |
|  | LO-P30 | 2 |

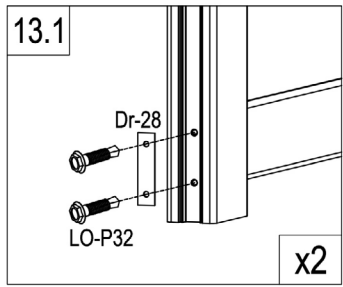
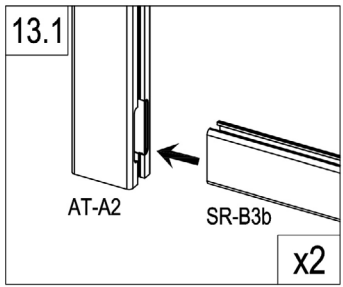
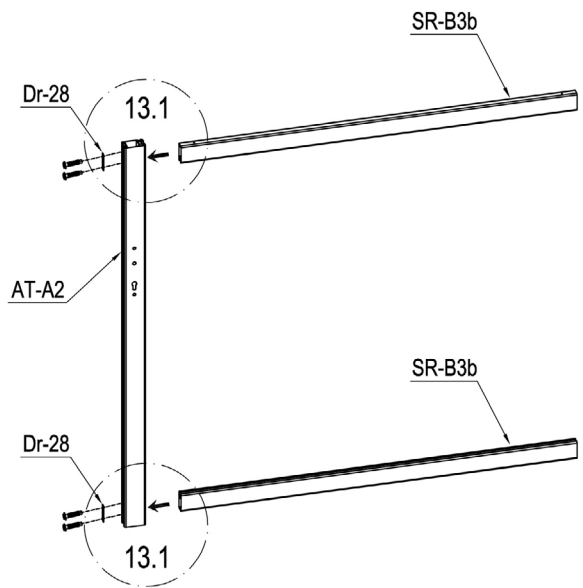

| | | |
|---|--------|---|
|  | AT-A7a | 1 |
|  | Dr-13 | 1 |
|  | Dr-14 | 1 |



| | | |
|---|--------|---|
|  | AT-A2 | 1 |
|  | SR-B3b | 2 |
|  | Dr-28 | 2 |
|  | LO-P32 | 4 |

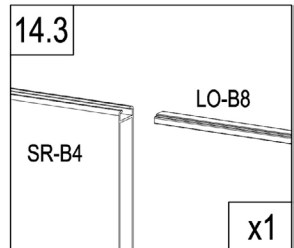
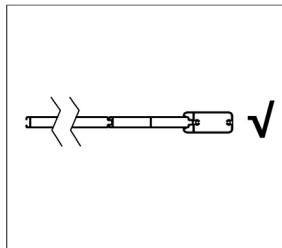
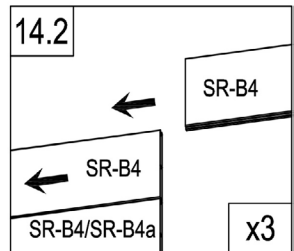
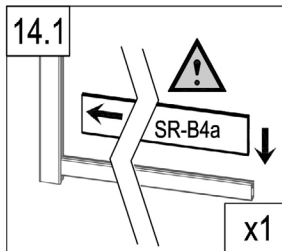
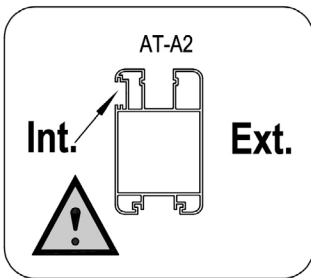
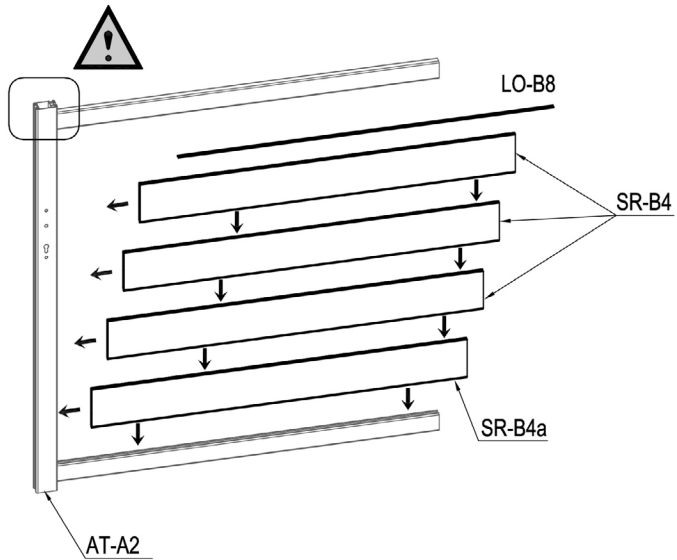

| | | |
|--|--------|---|
| | LO-B8 | 1 |
| | SR-B4 | 3 |
| | SR-B4a | 1 |

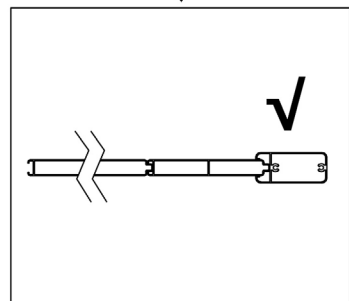
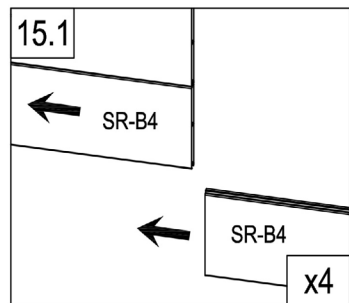
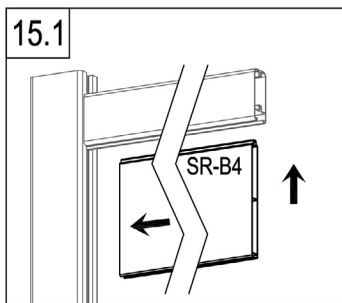
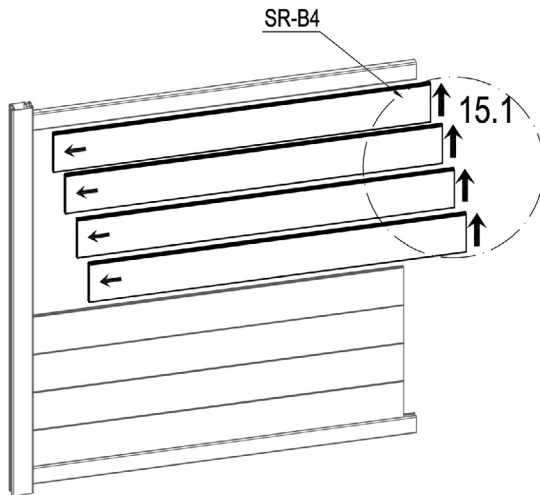

| | | |
|---|-------|---|
|  | SR-B4 | 4 |
|---|-------|---|

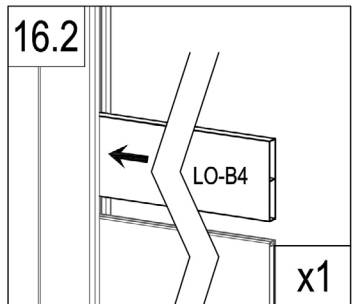
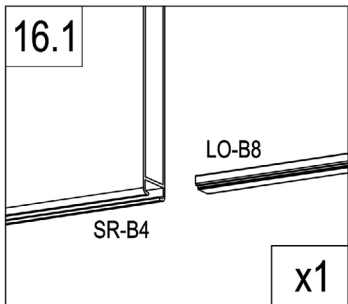
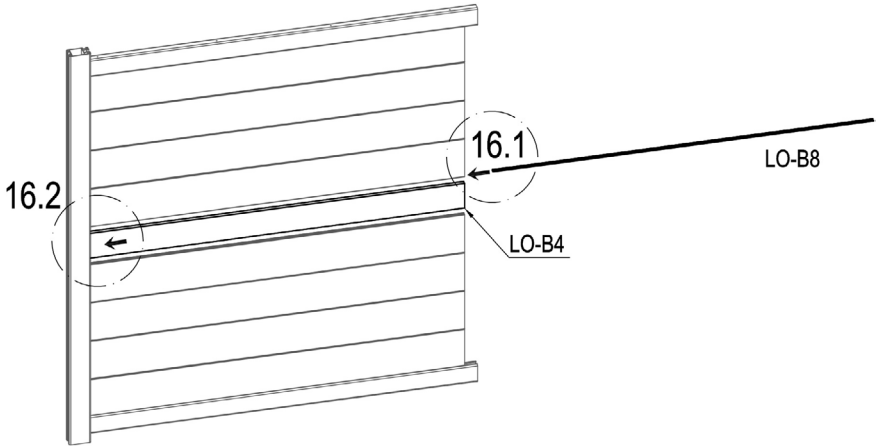

| | | |
|---|-------|---|
|  | LO-B4 | 1 |
|  | LO-B8 | 1 |

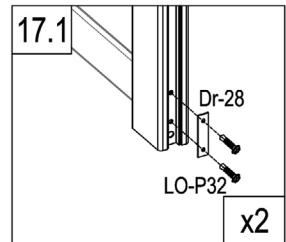
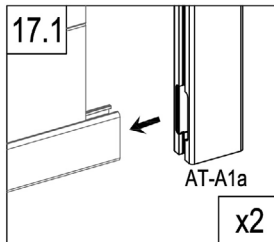
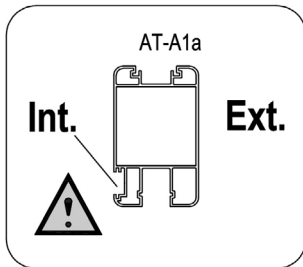
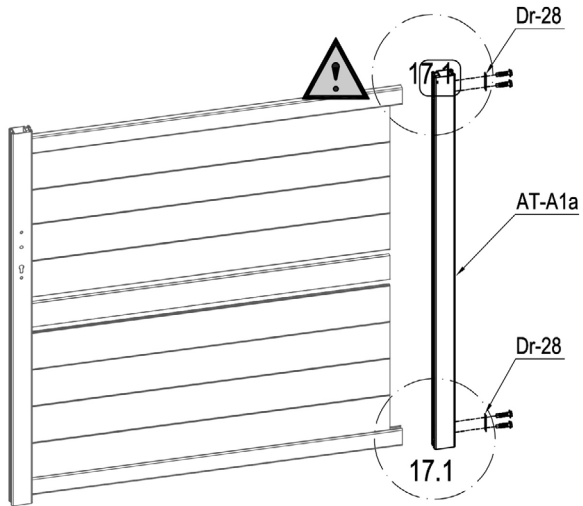

| | | |
|--|--------|---|
| | AT-A1a | 1 |
| | Dr-28 | 2 |
| | LO-P32 | 4 |

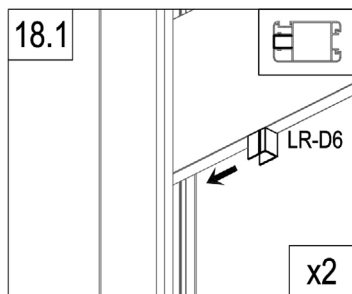
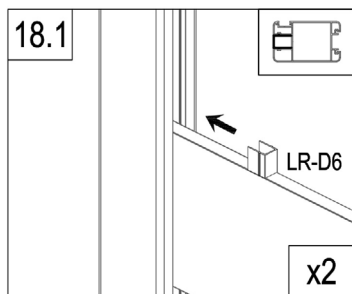
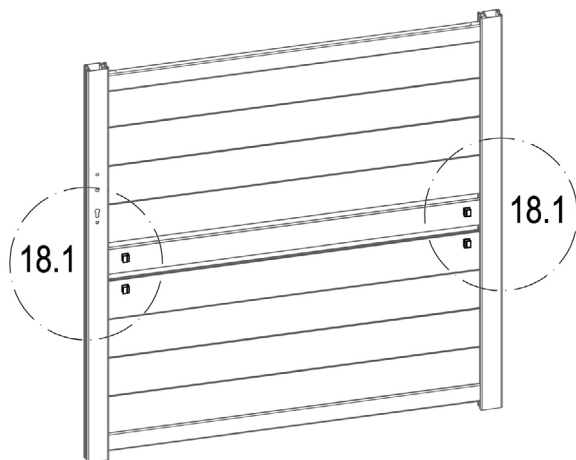

| | | |
|---|-------|---|
|  | LR-D6 | 4 |
|---|-------|---|

CASANOVO

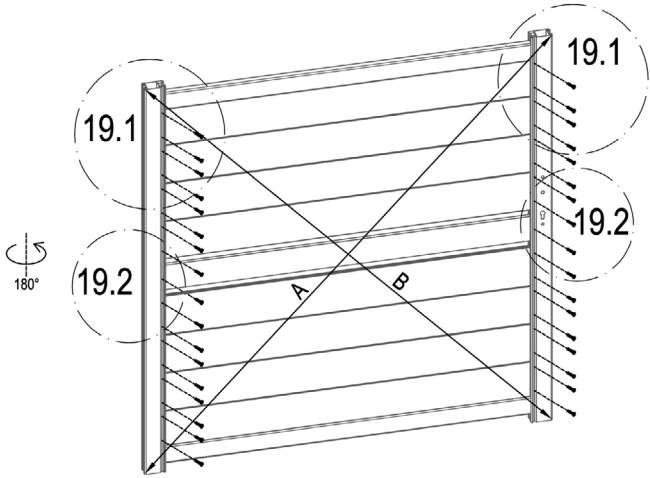

A=B

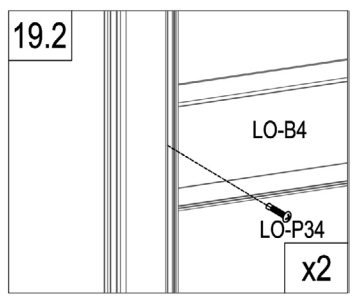
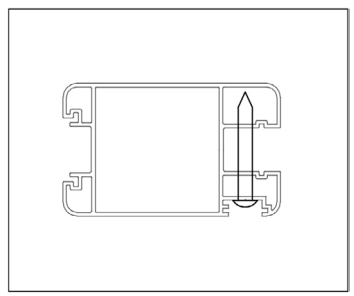
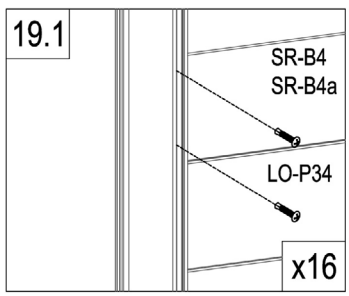

| | | |
|---|--------|----|
|  | LO-P34 | 34 |
|---|--------|----|

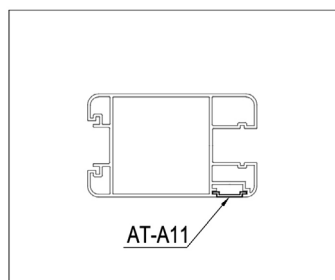
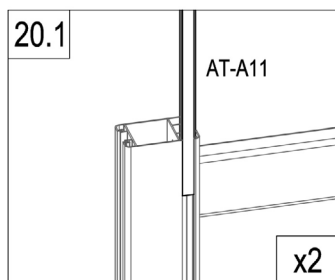
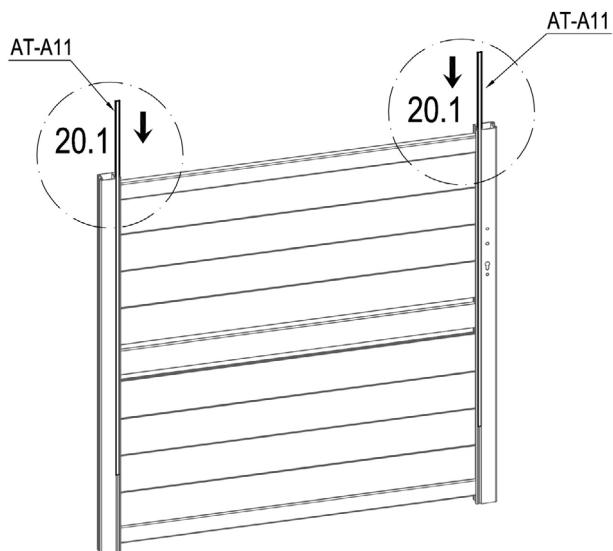

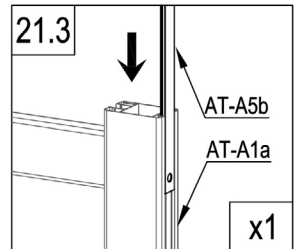
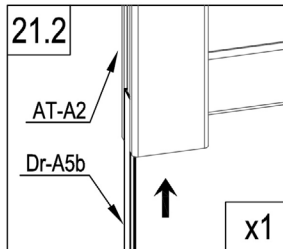
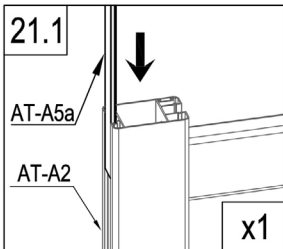
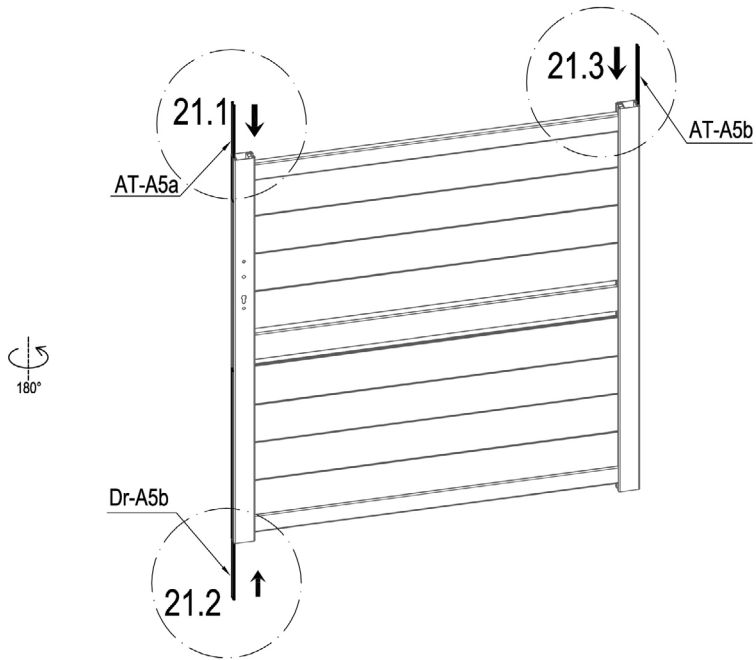

| | | |
|---|--------|---|
|  | AT-A11 | 2 |
|---|--------|---|



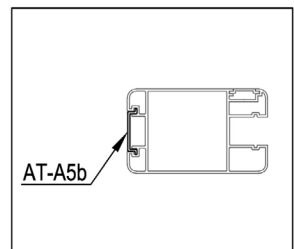

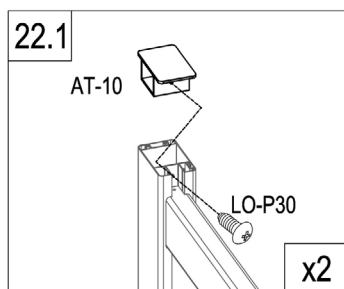
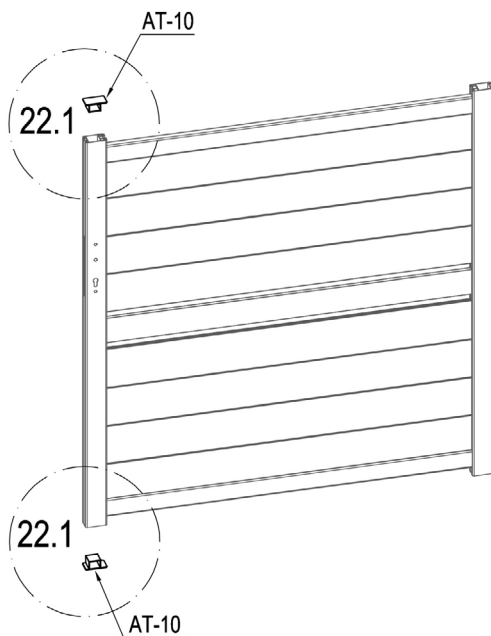
| | | |
|---|--------|---|
|  | AT-A5b | 1 |
| | AT-A5a | 1 |
| | Dr-A5b | 1 |



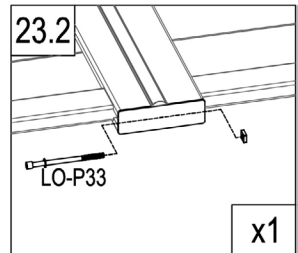
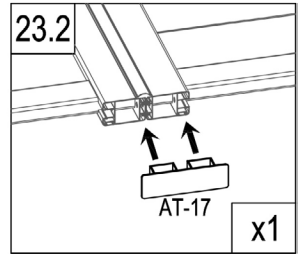
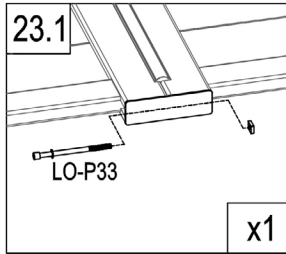
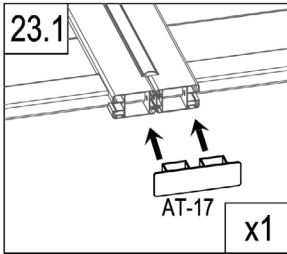
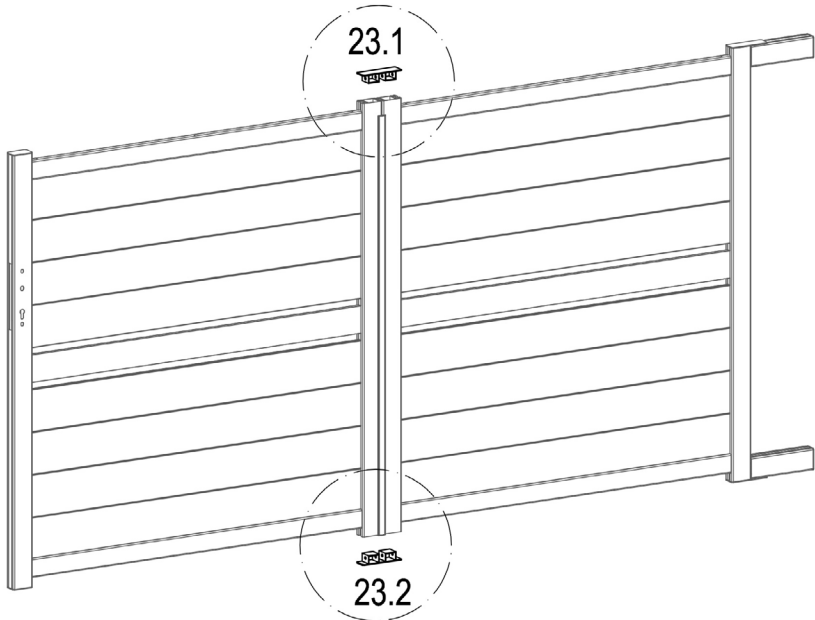

| | | |
|---|--------|---|
|  | AT-10 | 2 |
|  | LO-P30 | 2 |



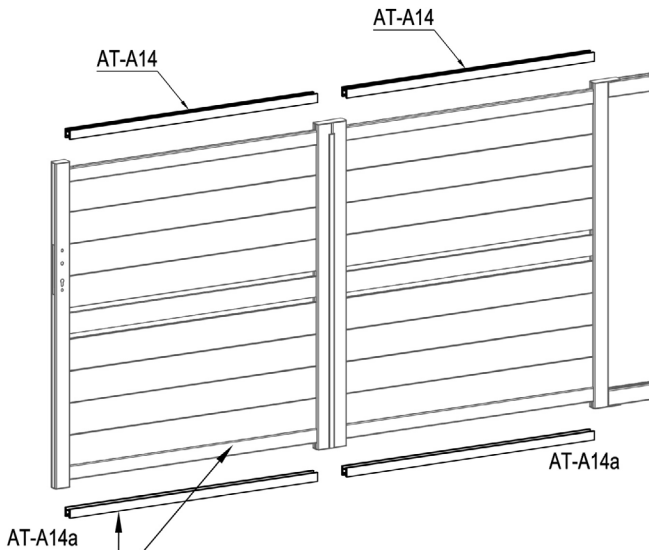

| | | |
|---|--------|---|
|  | AT-17 | 2 |
|  | LO-P33 | 2 |



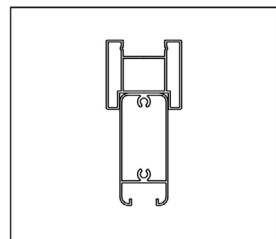
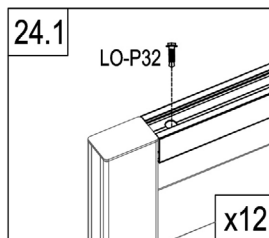
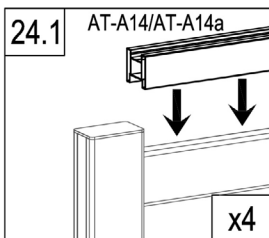

EN: These parts are made for connecting your gate's automation
 FR: Ces pièces sont faites pour relier l'automatisation de votre portail
 DE: Diese Teile sind für den Anschluss der Automatisierung Ihres Tores vorgesehen
 ES: Estas piezas están hechas para conectar la automatización de su puerta
 PT: Estas peças são feitas para ligar a automatização do seu portão
 IT: Queste parti sono realizzate per collegare l'automazione del vostro cancello
 NL: Deze onderdelen zijn gemaakt voor het aansluiten van de automatisering van uw poort.
 PL: Te części są wykonane do podłączenia automatyki bramy.



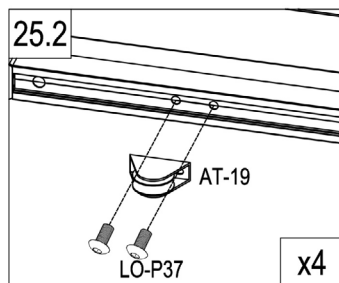
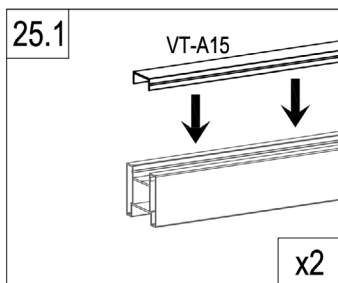
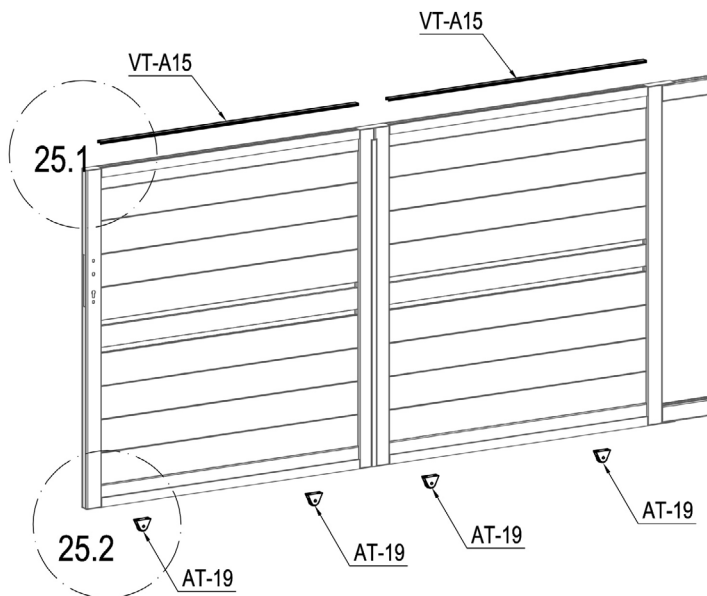

| | | |
|---|---------|----|
|  | AT-A14 | 2 |
| | AT-A14a | 2 |
|  | LO-P32 | 12 |

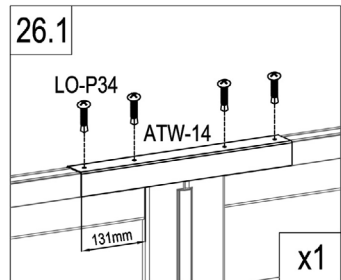
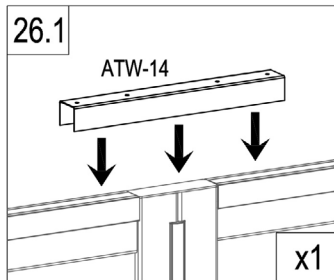
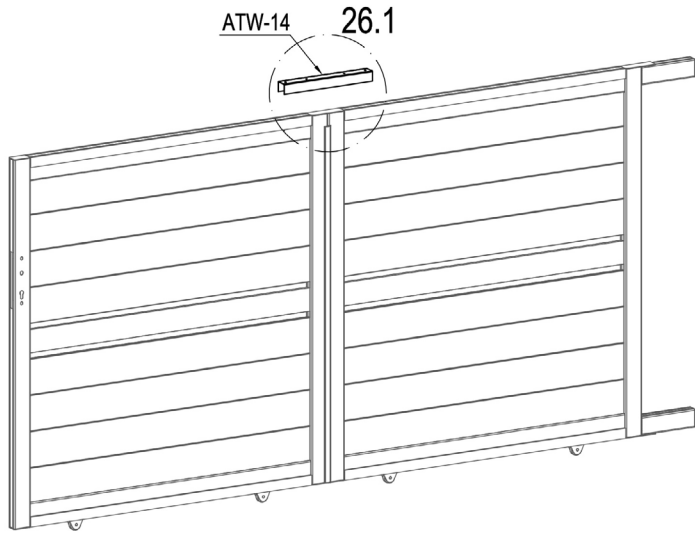

| | | |
|---|--------|---|
|  | VT-A15 | 2 |
|  | AT-19 | 4 |
|  | LO-P37 | 8 |



| | | |
|---|--------|---|
|  | ATW-14 | 1 |
|  | LO-P34 | 4 |

CASANOVO

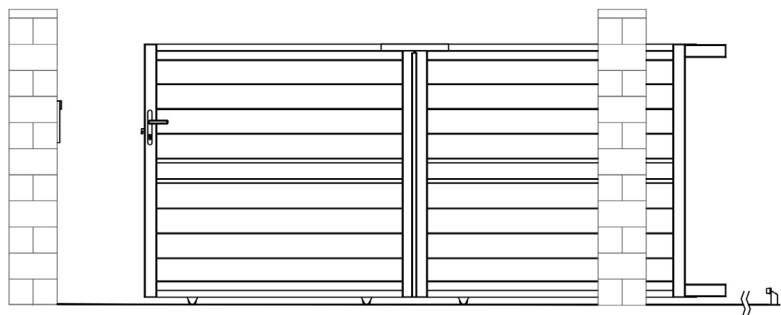

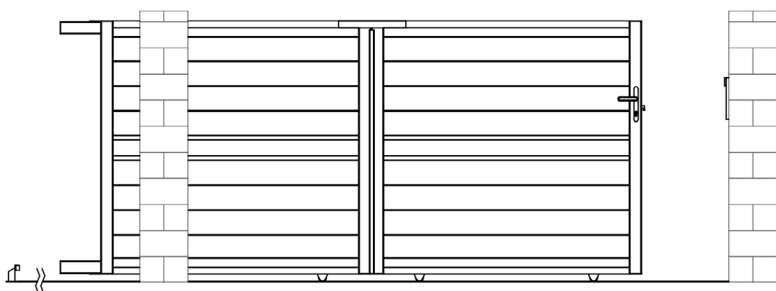

L

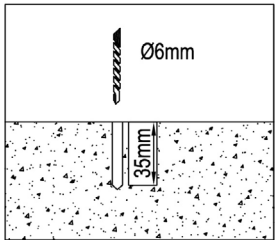
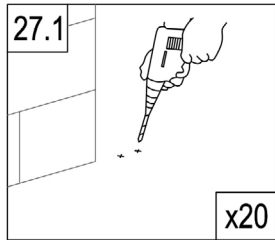
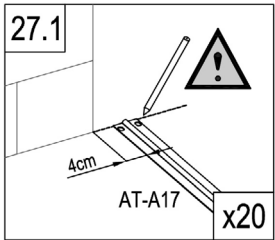
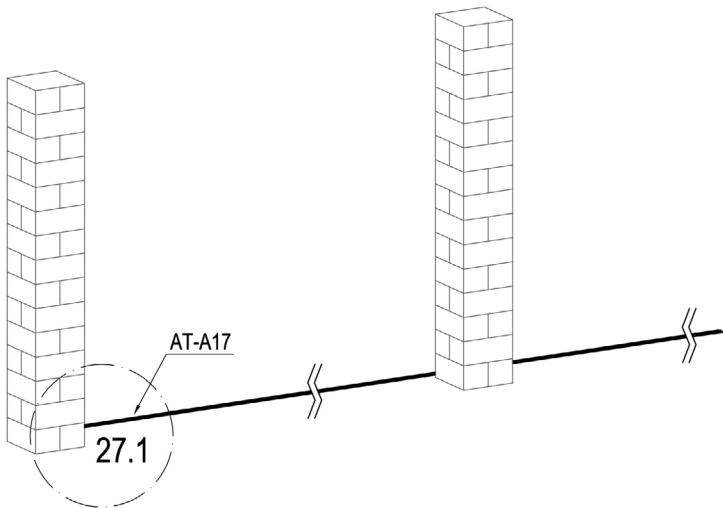

R

L



| | | |
|---|--------|----|
|  | AT-A17 | 5 |
|  | LO-P38 | 40 |

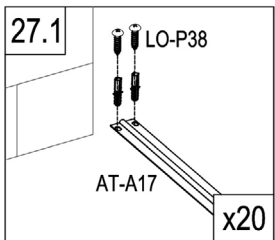

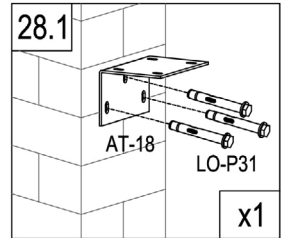
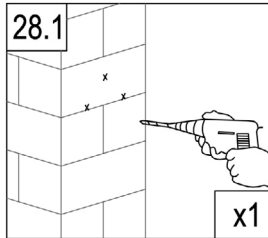
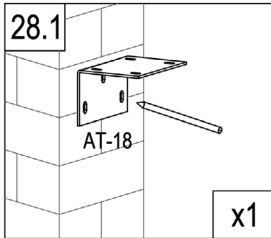
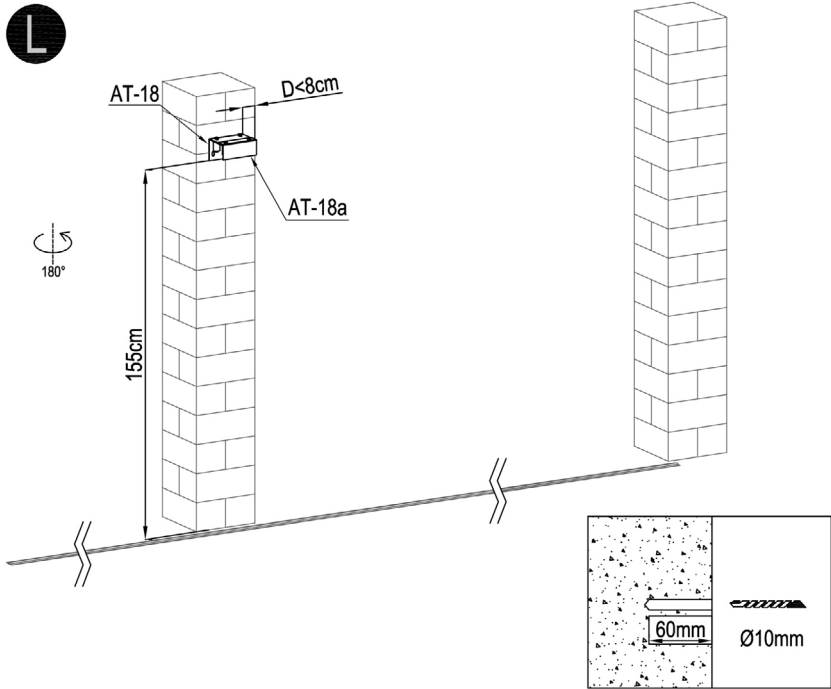

| | | |
|--|--------|---|
| | AT-18 | 1 |
| | AT-18a | 1 |
| | AT-20 | 4 |
| | LO-P31 | 3 |

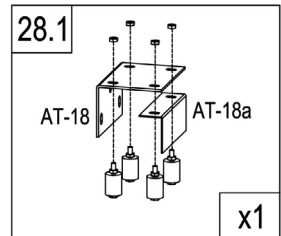
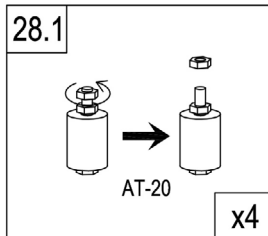

L

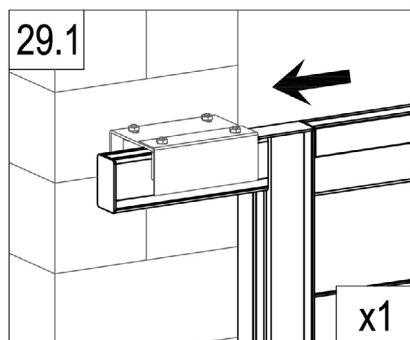
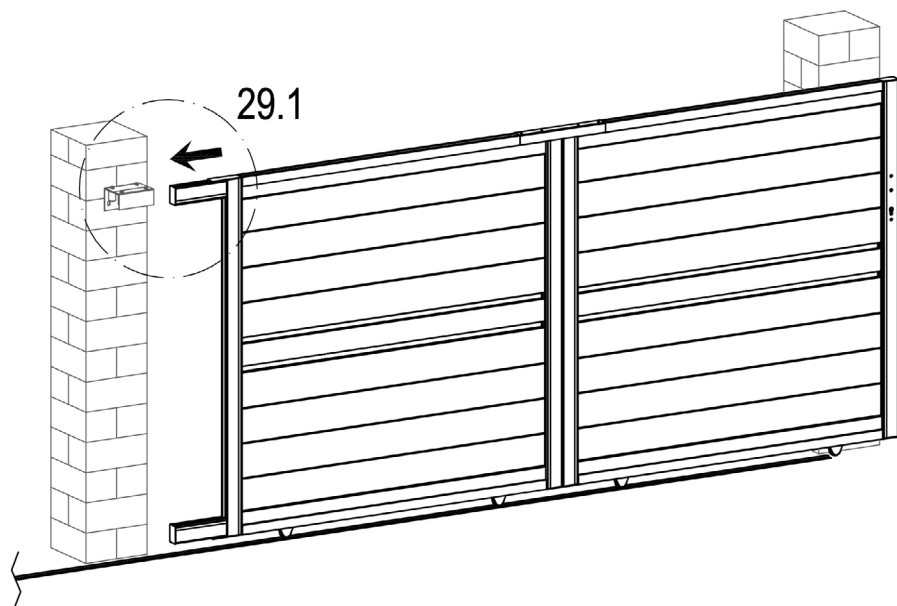

L

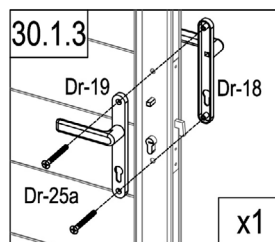
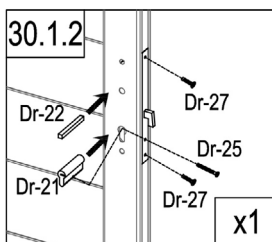
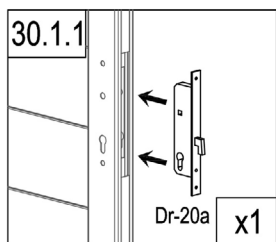
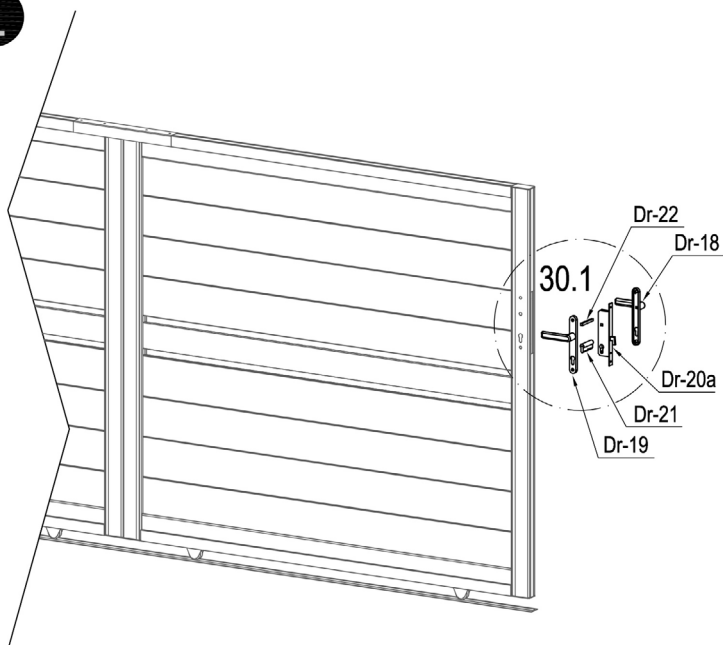

| | | |
|--|--------|---|
| | Dr-20a | 1 |
| | Dr-21 | 1 |
| | Dr-22 | 1 |
| | Dr-25 | 1 |

| | | |
|--|--------|---|
| | Dr-18 | 1 |
| | Dr-19 | 1 |
| | Dr-25a | 2 |
| | Dr-27 | 2 |

L

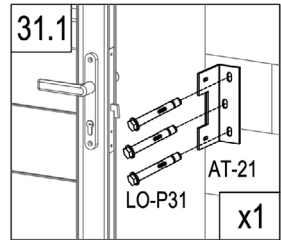
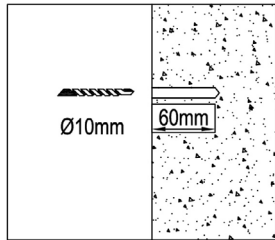
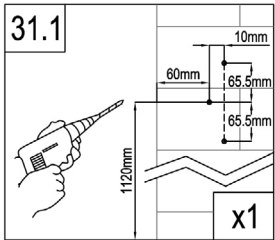
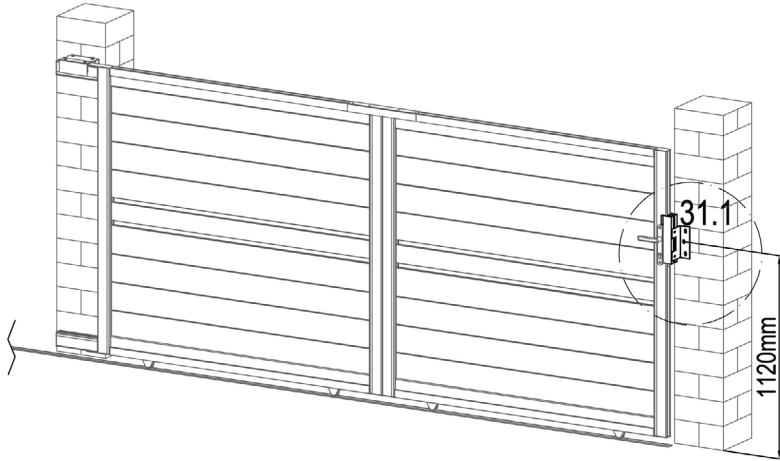

| | | |
|--|--------|---|
| | AT-16 | 1 |
| | AT-21 | 1 |
| | LO-P36 | 2 |
| | LO-P31 | 3 |
| | AT-22J | 3 |

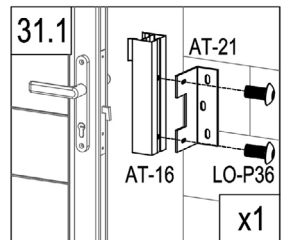
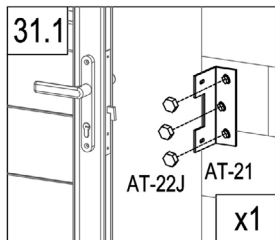

L

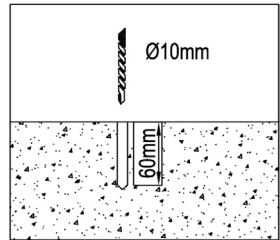
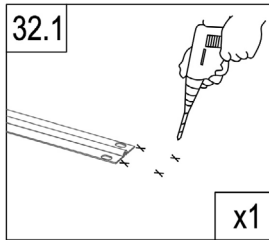
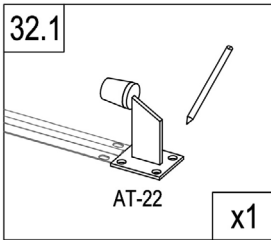
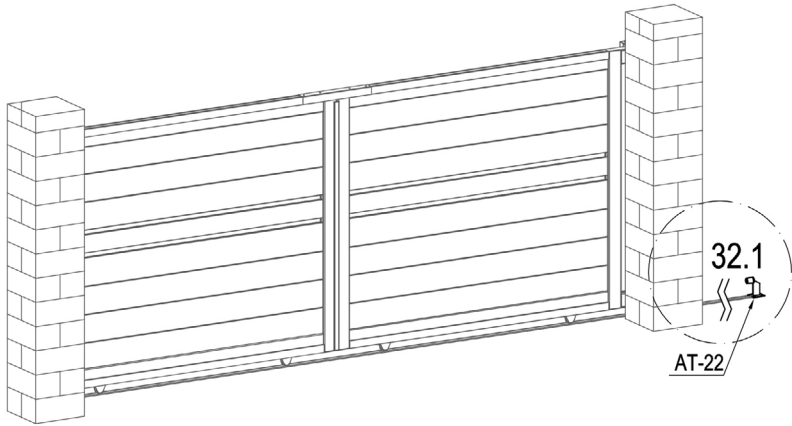

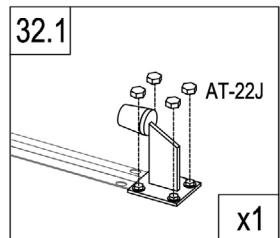
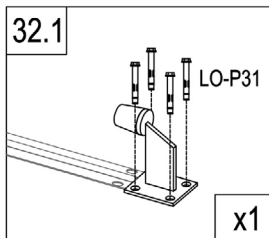

| | | |
|--|--------|---|
| | AT-22 | 1 |
| | LO-P31 | 4 |
| | AT-22J | 4 |

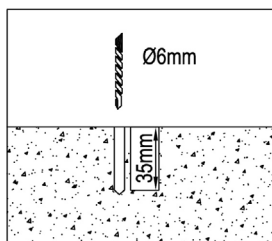
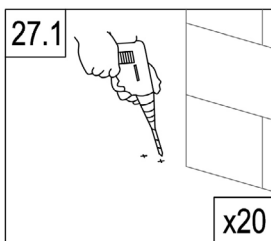
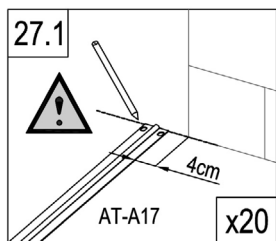
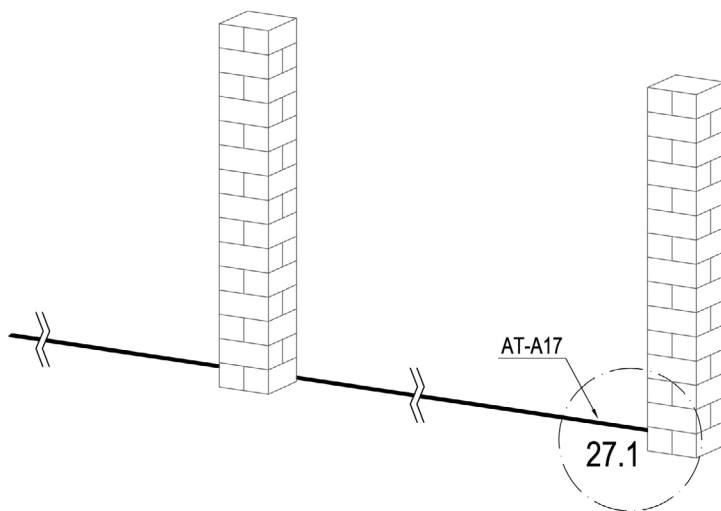

R



| | | |
|---|--------|----|
|  | AT-A17 | 5 |
|  | LO-P38 | 40 |

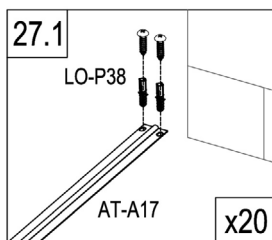

R

180°

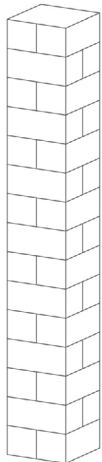

$D < 8\text{cm}$ AT-18

AT-18a

155cm

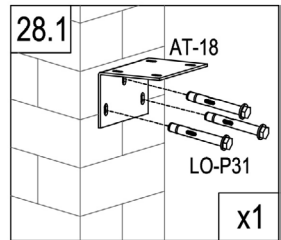
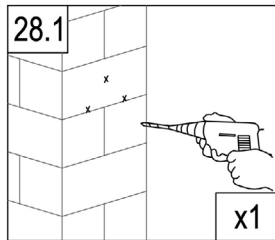
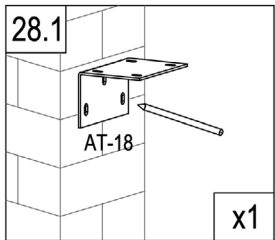
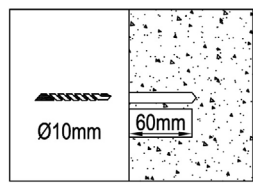
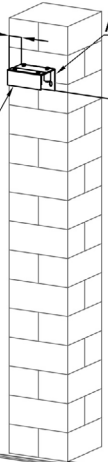

| | | |
|--|--------|---|
| | AT-18 | 1 |
| | AT-18a | 1 |
| | AT-20 | 4 |
| | LO-P31 | 3 |

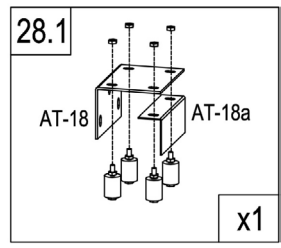
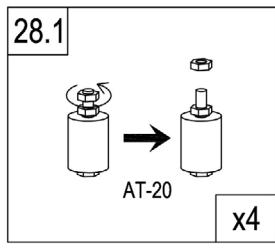

R

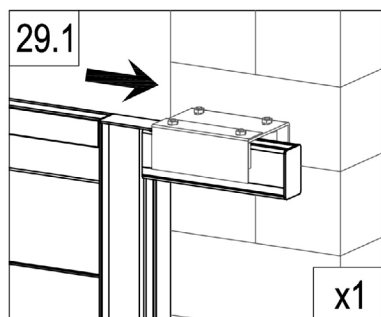
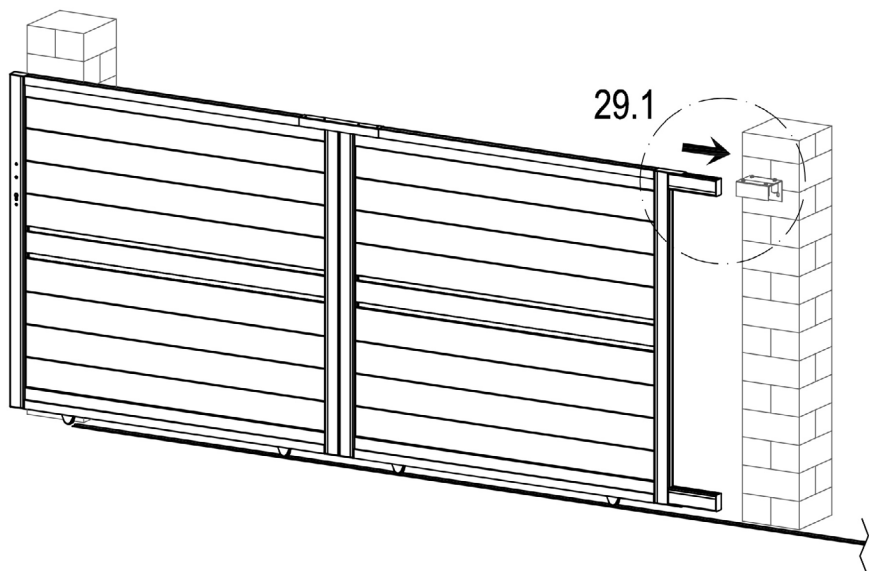

R

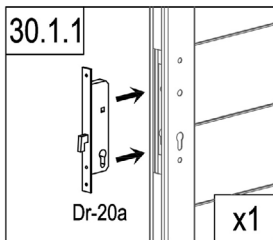
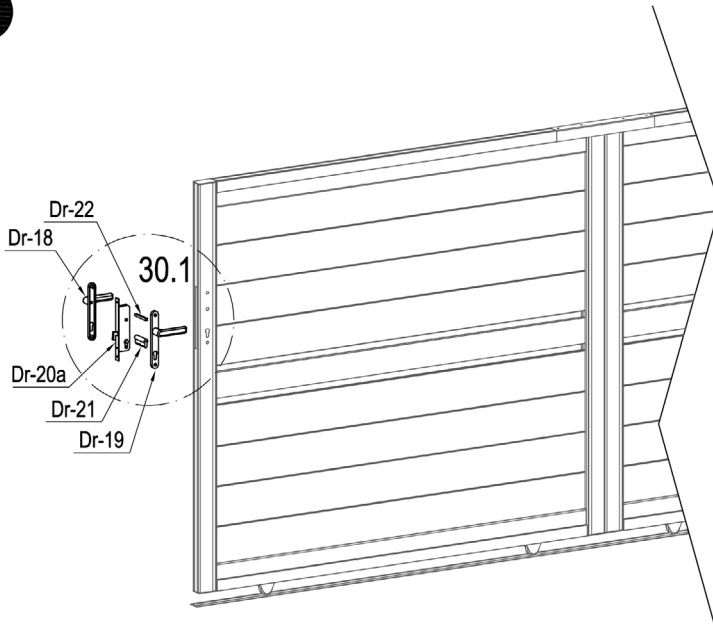

| | | |
|--|--------|---|
| | Dr-20a | 1 |
| | Dr-21 | 1 |
| | Dr-22 | 1 |
| | Dr-25 | 1 |

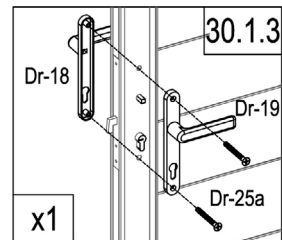
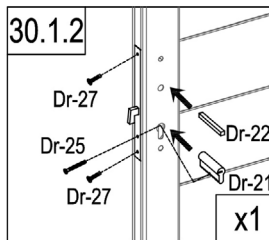

| | | |
|--|--------|---|
| | Dr-18 | 1 |
| | Dr-19 | 1 |
| | Dr-25a | 2 |
| | Dr-27 | 2 |

R

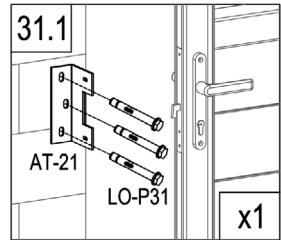
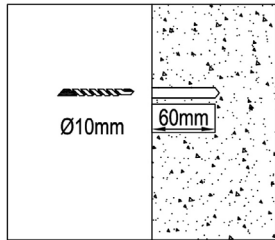
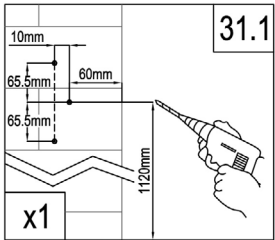
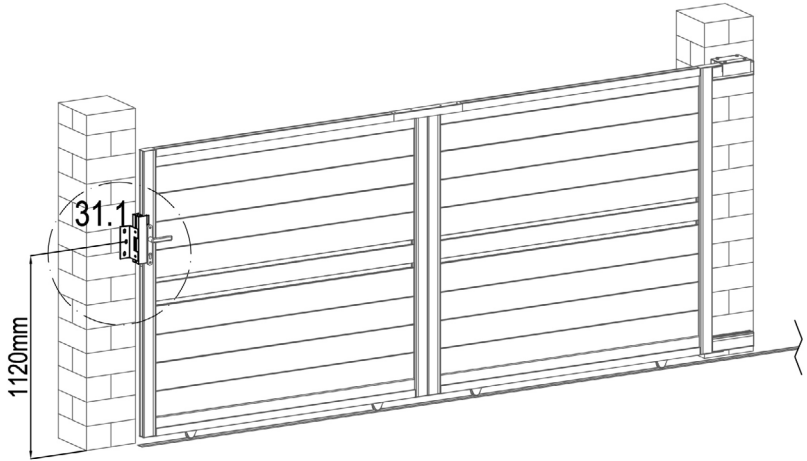

| | | |
|--|--------|---|
| | AT-16 | 1 |
| | AT-21 | 1 |
| | LO-P36 | 2 |
| | LO-P31 | 3 |
| | AT-22J | 3 |

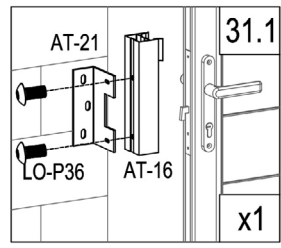
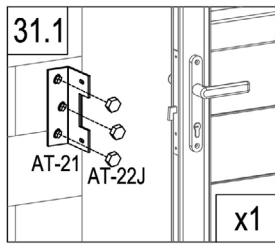

R

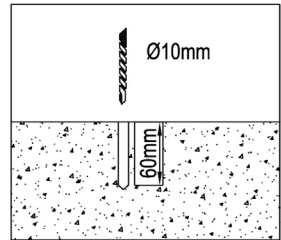
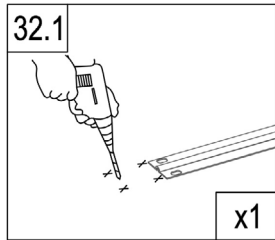
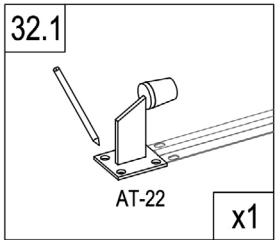
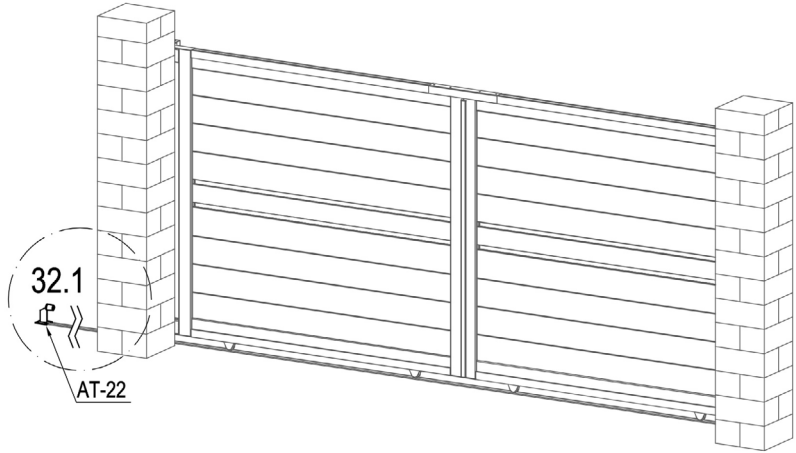

| | | |
|--|--------|---|
| | AT-22 | 1 |
| | LO-P31 | 4 |
| | AT-22J | 4 |

