

# CASANOVO

## CIMONE 300C140

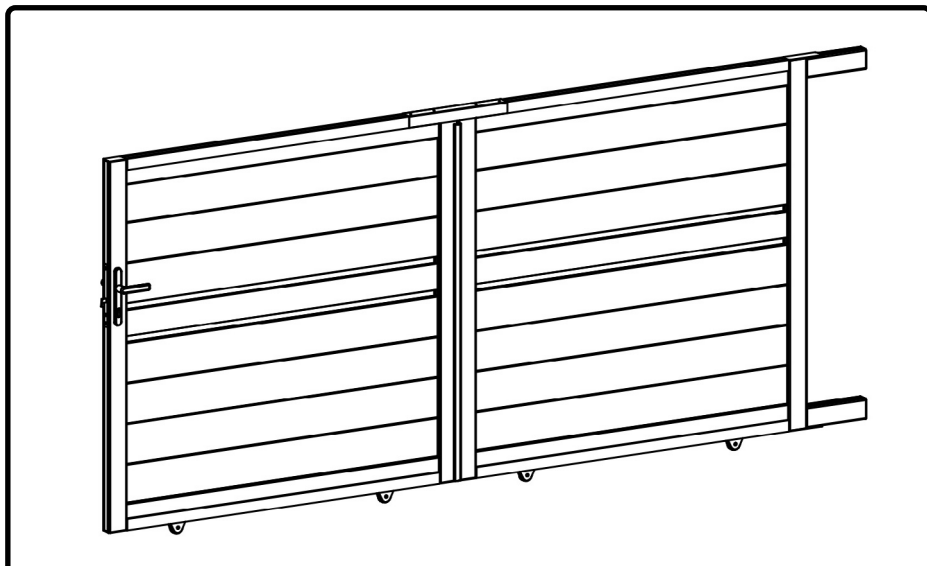

COM-001193 [x1]

COM-001194 [x1]

COM-001195 [x1]



INSTRUCTION MANUAL / NOTICE DE MONTAGE / MONTAGEANLEITUNG / MANUAL DE MONTAJE / MANUAL DE MONTAGEM / MANUALE DI MONTAGGIO /  
MONTAGEHANDLEIDING / INSTRUKCJA MONTAŻU / KÄYTTÖOHJEET / BRUKSANVISNING / BRUGSANVISNING / INSTRUCIUNI DE ASAMBLARE /  
NAVODILA ZA SESTAVLJANJE / NÁVOD NA MONTÁŽ / ÖSSZESZERELÉSI ÚTMUTATÓ / NÁVOD K MONTÁŽI / UPUTE ZA INSTALACIJU /  
ΟΔΗΓΙΕΣ ΣΥΝΑΡΜΟΛΟΓΗΣΗΣ / SURINKIMO INSTRUKCIJOS / MONTĀŽAS INSTRUKCIJAS

Ext.

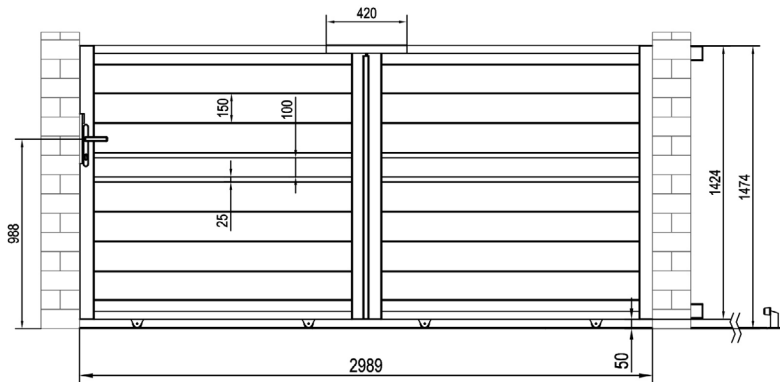

Int.

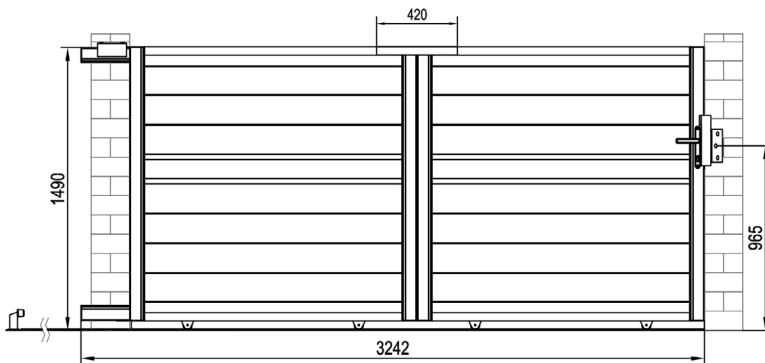

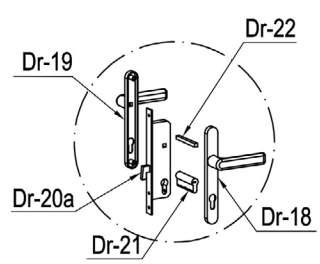
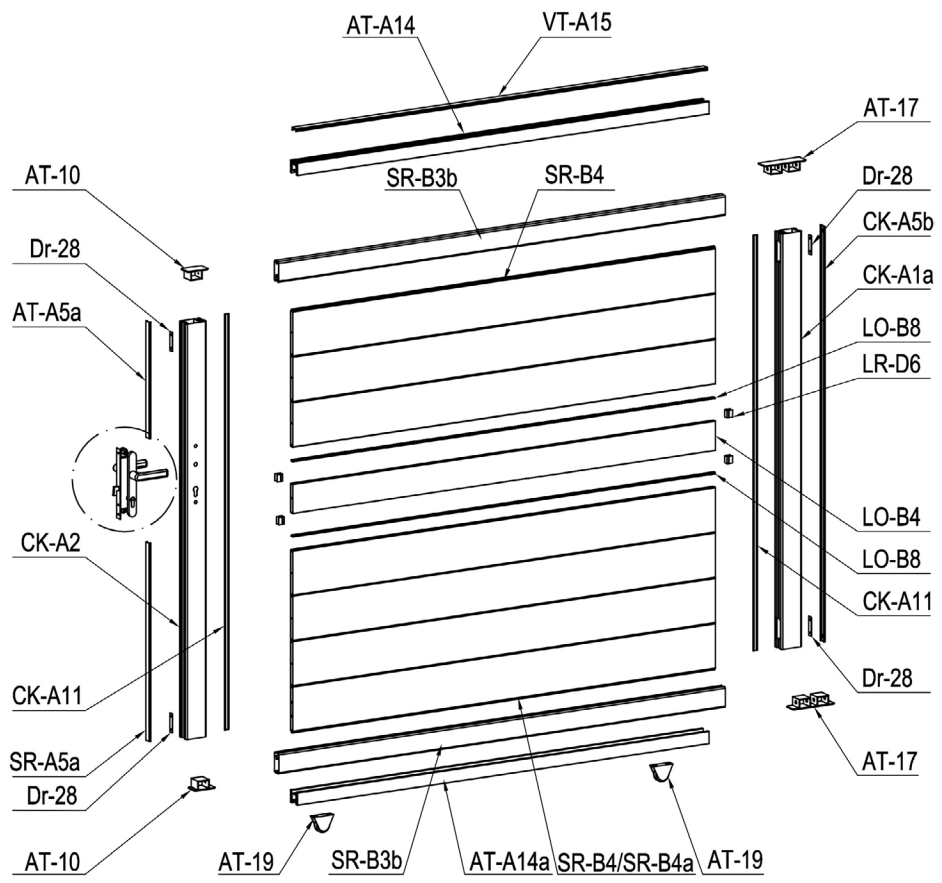

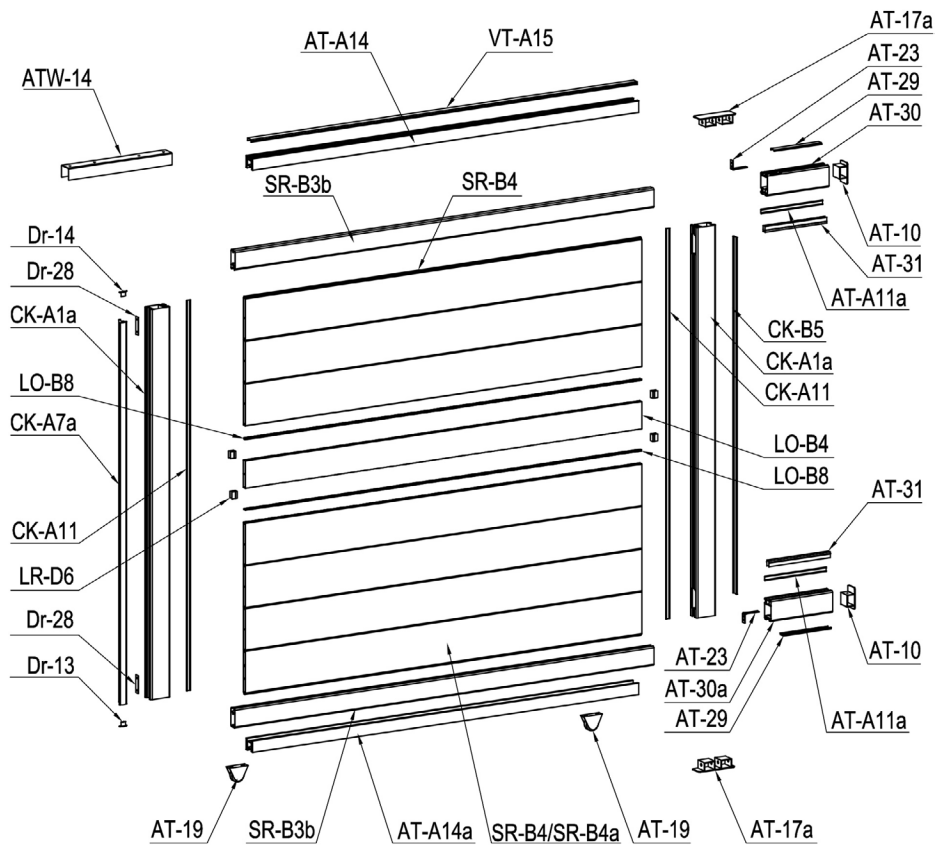

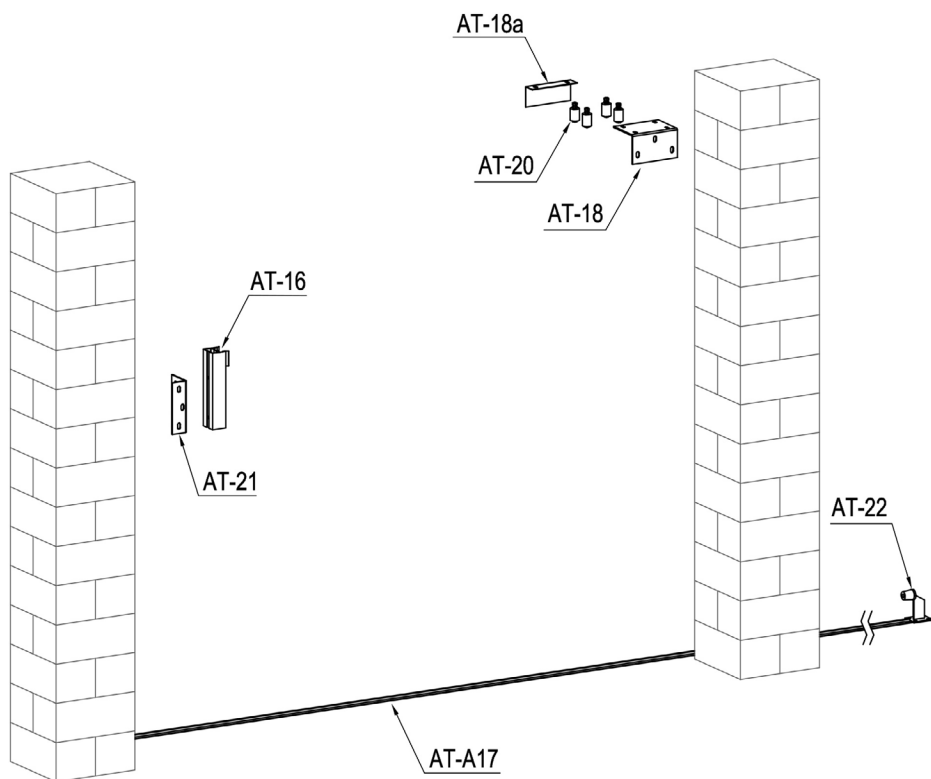

















































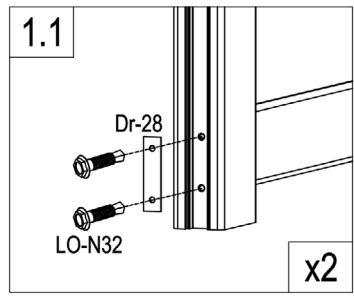
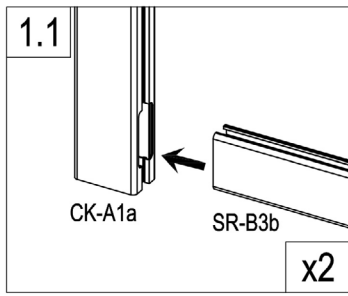
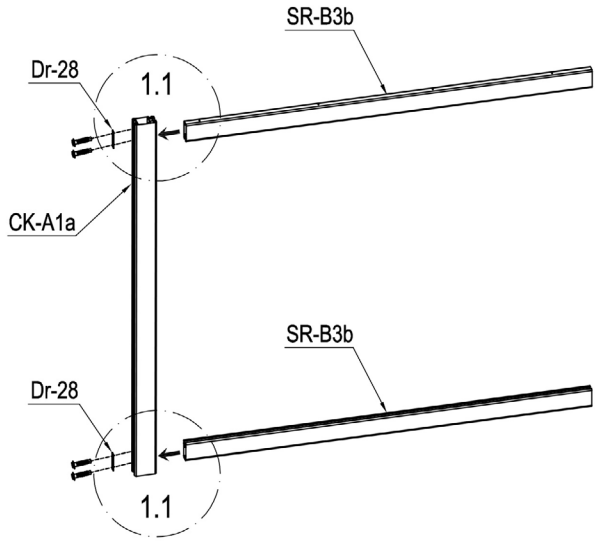

# CASANOVO

IMAGE	NO.	L.(mm)	QTY	IMAGE	NO.	L.(mm)	QTY
	CK-A1a	1418	3		Dr-14		1
	CK-A2	1418	1		AT-18		1
	AT-30	250	1		AT-18a		1
	AT-30a	250	1		ATW-14	420	1
	SR-B3b	1471	4		AT-19		4
	SR-B4a	1380	2		AT-20		4
	SR-B4	1380	12		AT-21		1
	LO-B4	1380	2		AT-22		1
	CK-A5b	1418	1		AT-23		2
	CK-B5	1293	1		Dr-18		1
	AT-A5a	395.5	1		Dr-19		1
	SR-A5a	782	1		Dr-20a		1
	AT-29	193	2		Dr-21		1
	CK-A11	1418	4		Dr-22		1
	AT-A11a	250	2		Dr-25		1
	AT-31	250	2		Dr-25a		2
	LR-D6	25	8		Dr-27		2
	LO-B8	1379	4		Dr-28		6
	CK-A7a	1365	1		AT-22J		7
	AT-A14	1338	2		LO-N30	ST4x10	4
	AT-A14a	1338	2		LO-N31	M8x60	10
	VT-A15	1337	2		LO-N32	ST5.5x38	28
	AT-16	260	1		LO-N33	M8x130	4
	AT-A17	1212	5		LO-N34	ST4.8x38	64
	AT-17		2		LO-N35	ST4.2x19	6
	AT-17a		2		LO-N36	M6x20	2
	AT-10		4		LO-N37	M8x20	8
	Dr-13		1		LO-N38	ST4x25	40



	CK-A1a	1
	SR-B3b	2
	Dr-28	2
	LO-N32	4

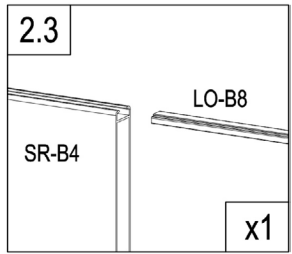
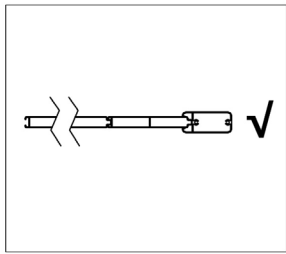
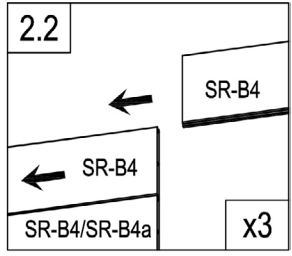
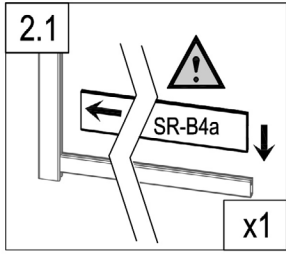
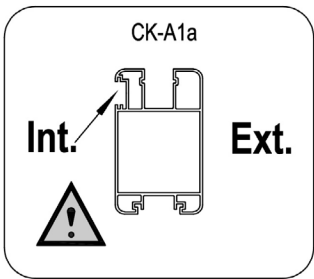
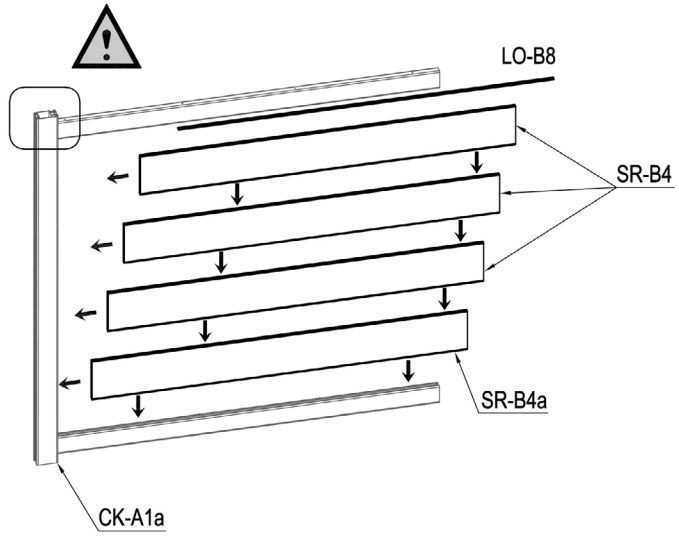

	LO-B8	1
	SR-B4	3
	SR-B4a	1



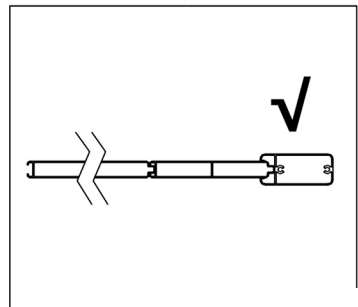
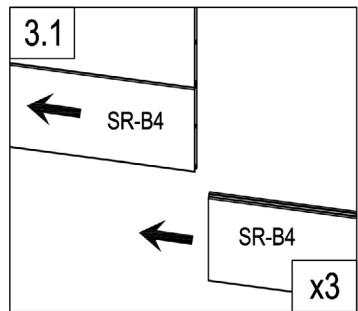
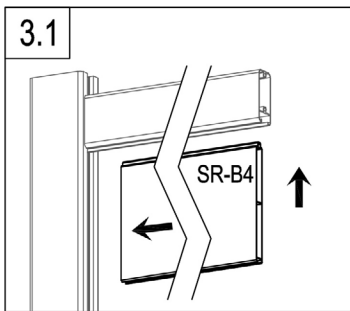
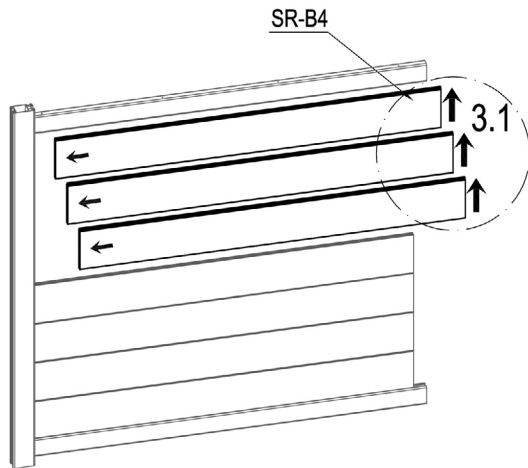

# CASANOVO



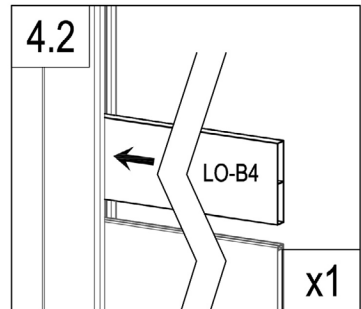
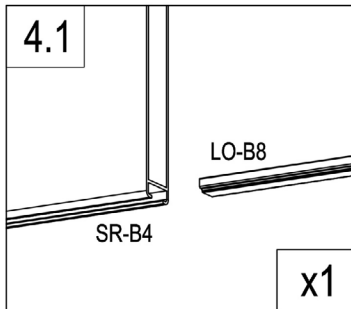
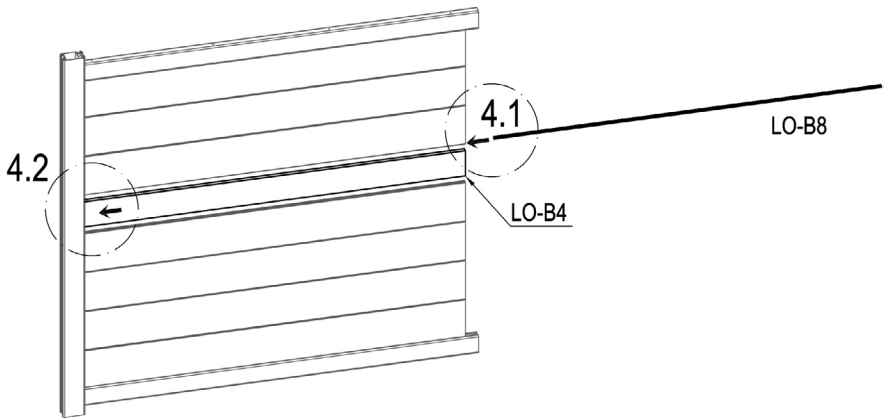

	SR-B4	3
---	-------	---

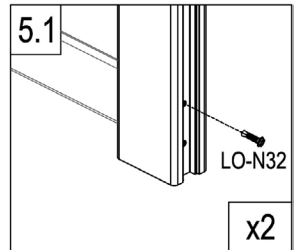
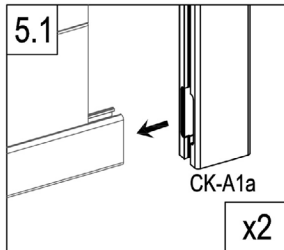
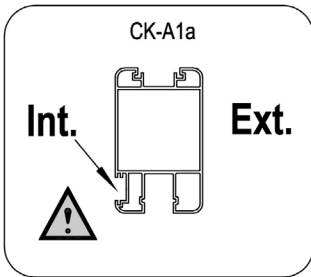
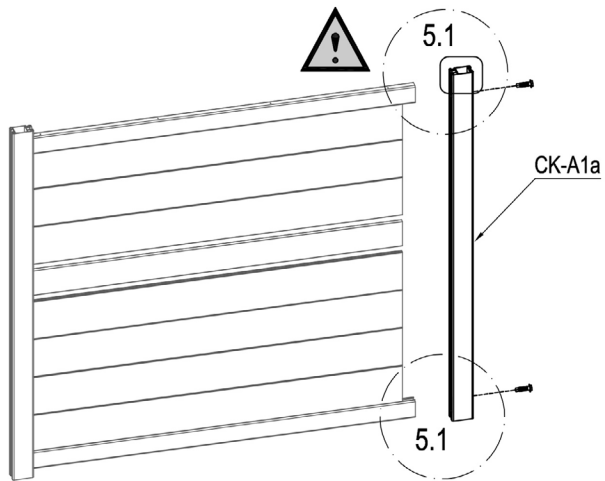

	LO-B4	1
	LO-B8	1



	CK-A1a	1
	LO-N32	2

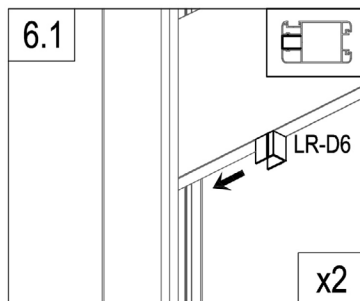
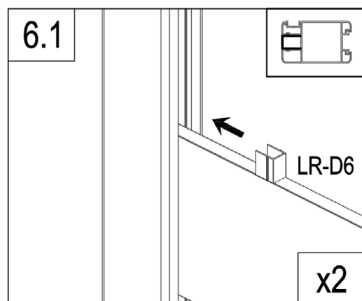
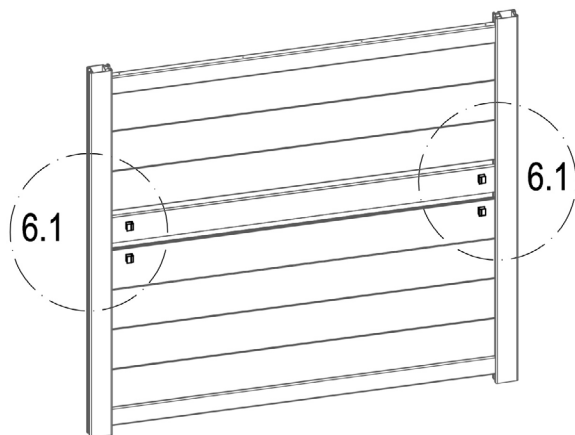

	LR-D6	4
---	-------	---

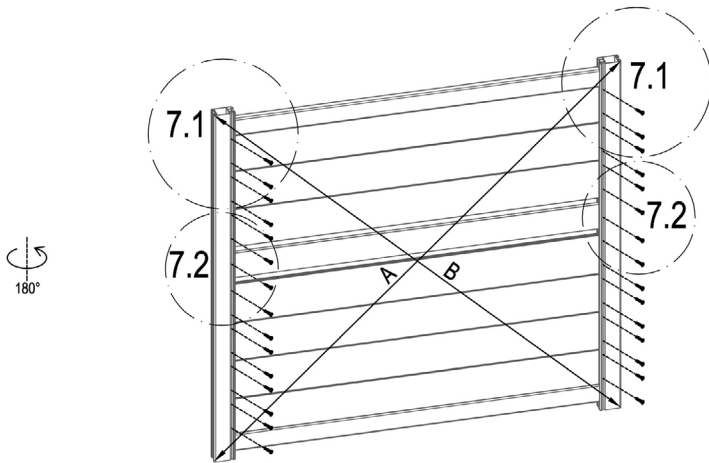

A=B

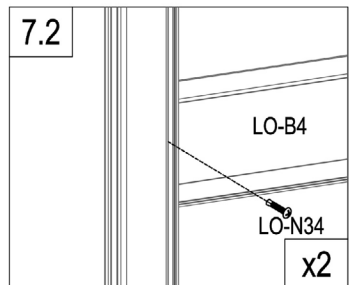
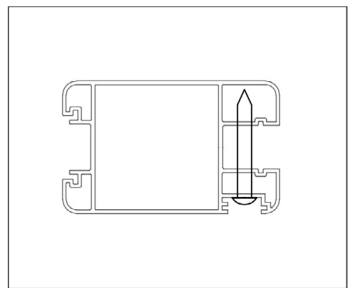
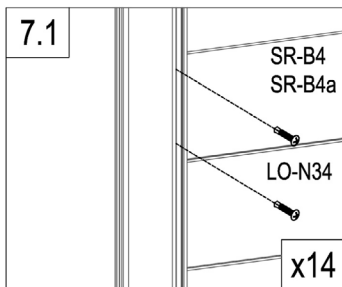

	LO-N34	30
---	--------	----

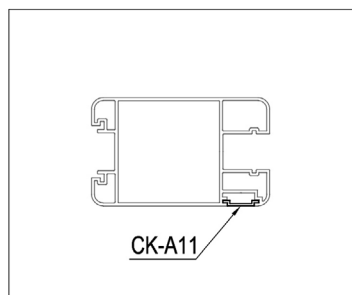
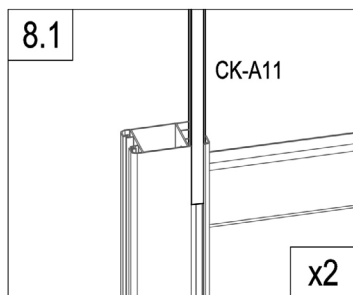
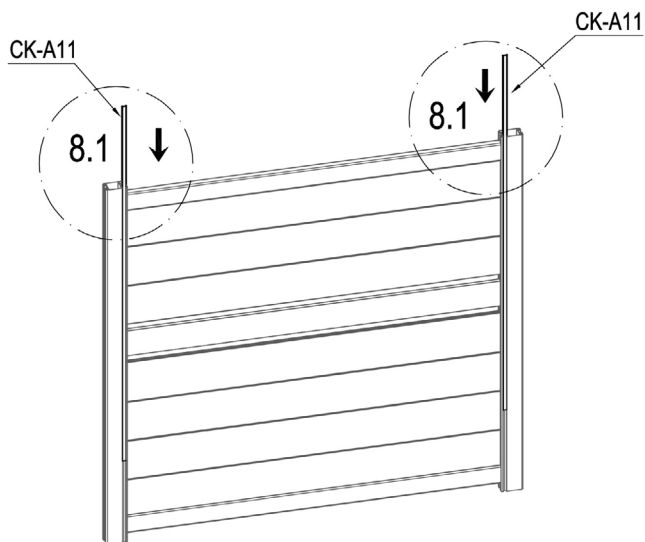

	CK-A11	2
---	--------	---

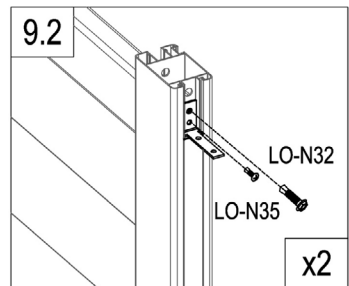
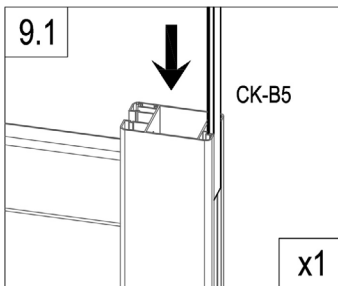
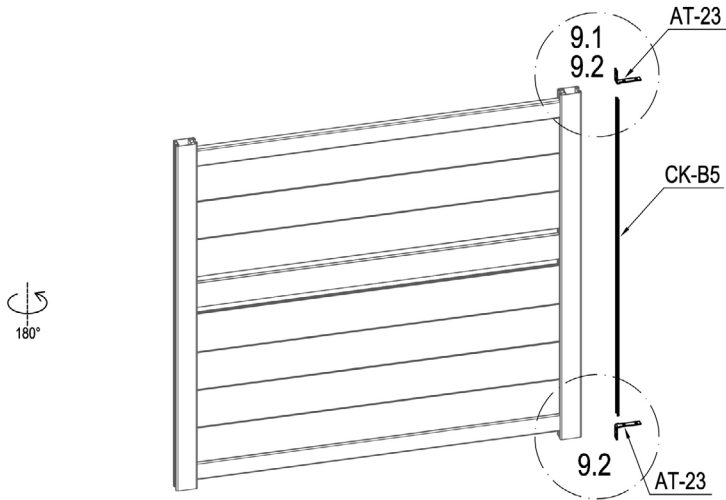

	CK-B5	1
	AT-23	2
	LO-N32	2
	LO-N35	2

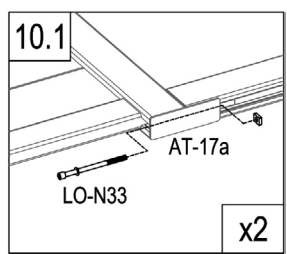
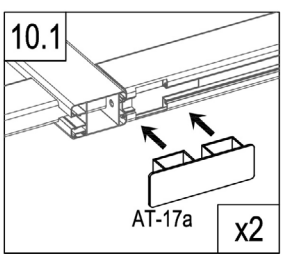
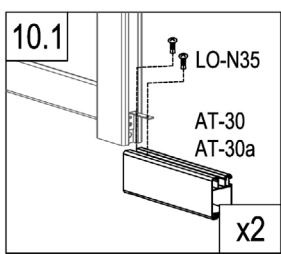
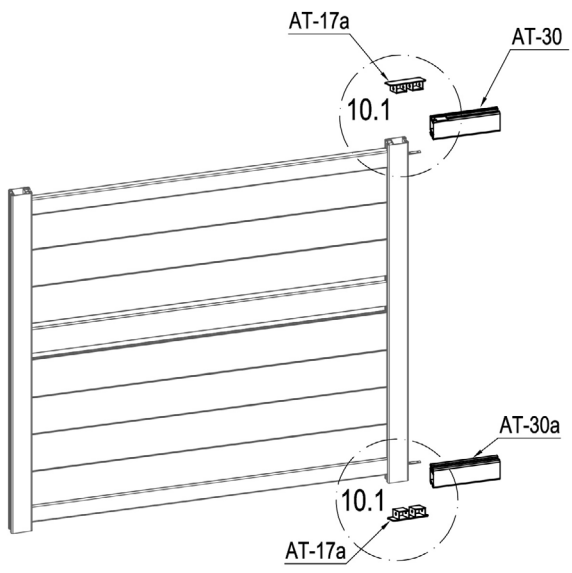



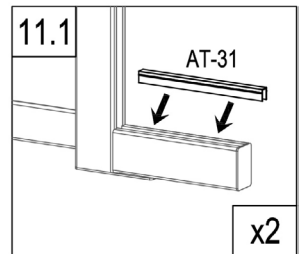
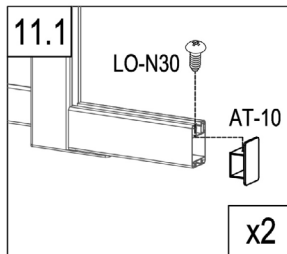
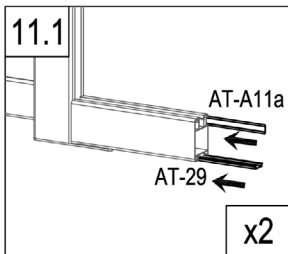
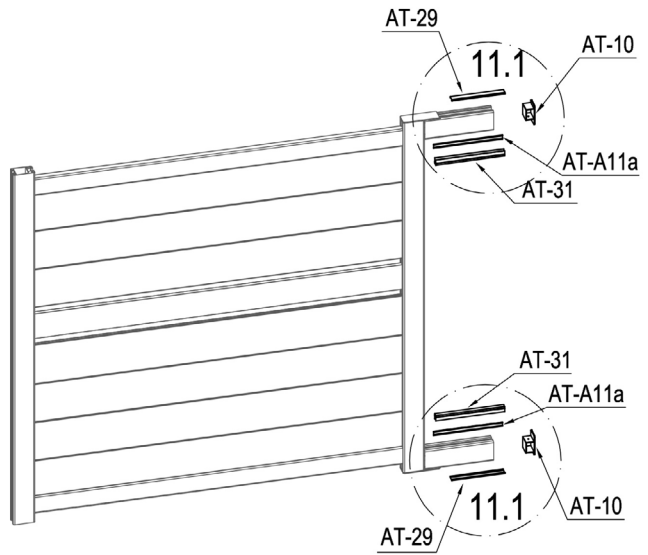

	AT-30	1
	AT-30a	1
	AT-17a	2

	LO-N33	2
	LO-N35	4









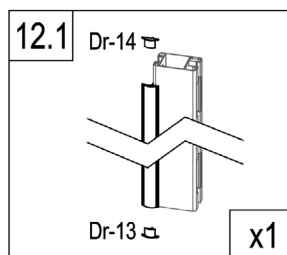
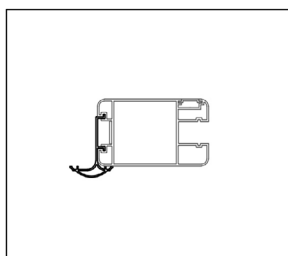
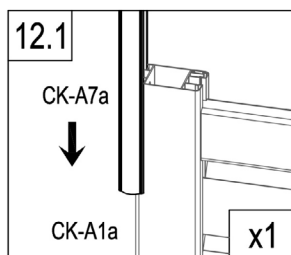
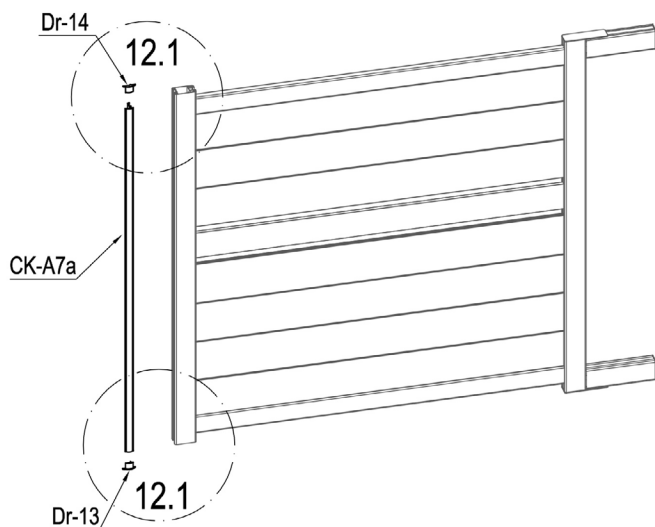

	AT-29	2
	AT-A11a	2
	AT-31	2

	AT-10	2
	LO-N30	2

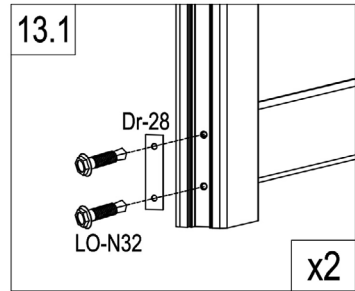
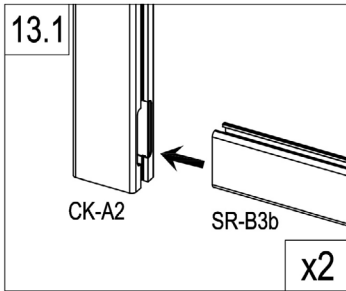
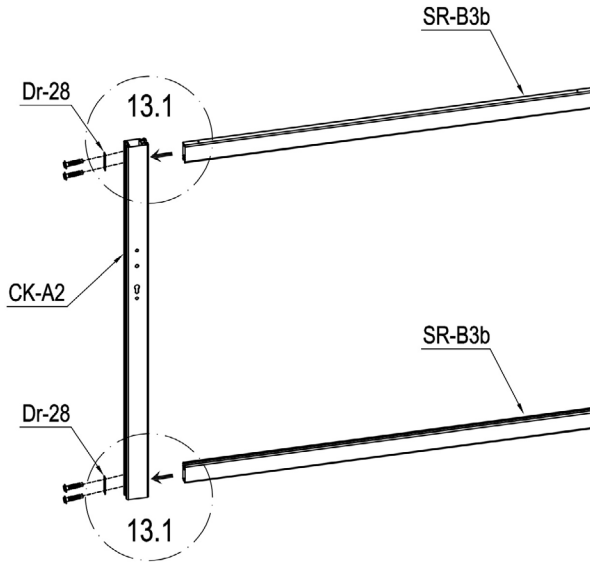



	CK-A7a	1
	Dr-13	1
	Dr-14	1

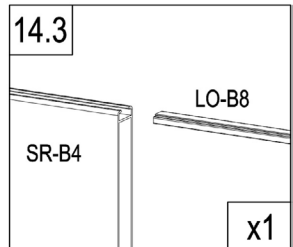
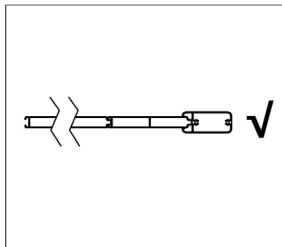
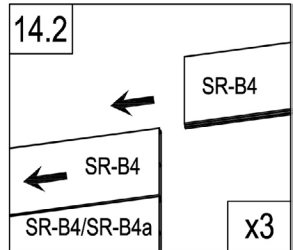
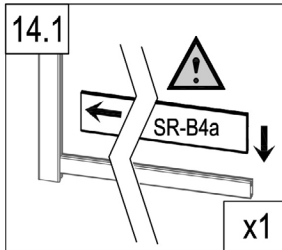
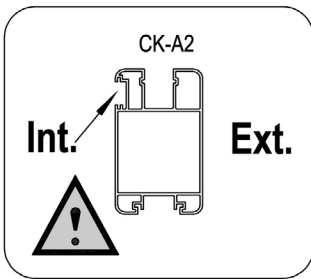
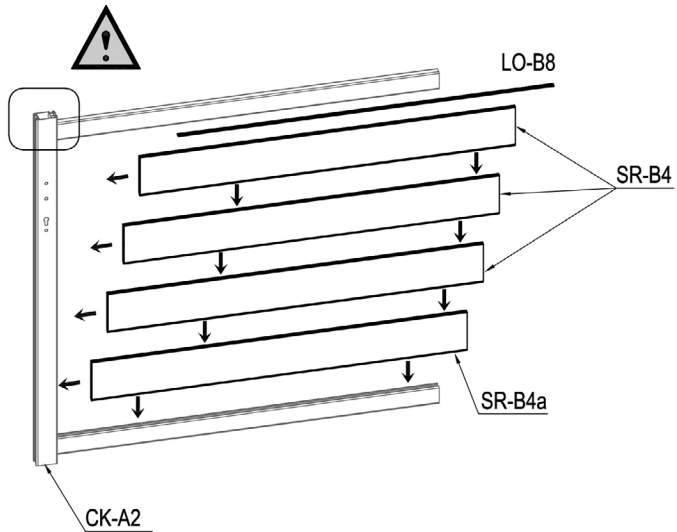

	CK-A2	1
	SR-B3b	2
	Dr-28	2
	LO-N32	4



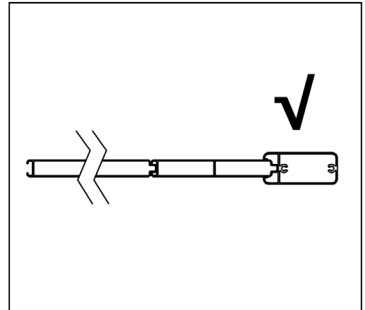
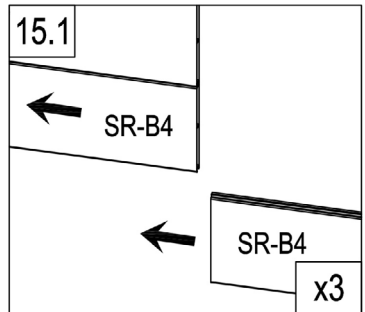
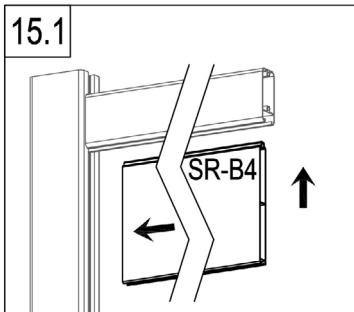
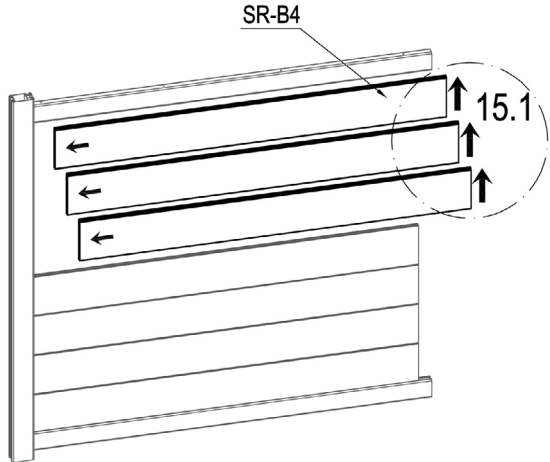

	LO-B8	1
	SR-B4	3
	SR-B4a	1

# CASANOVO



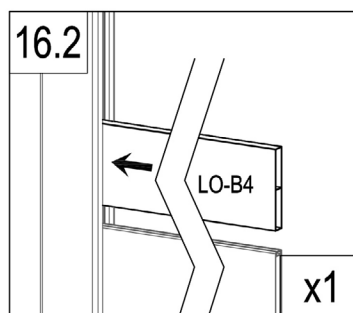
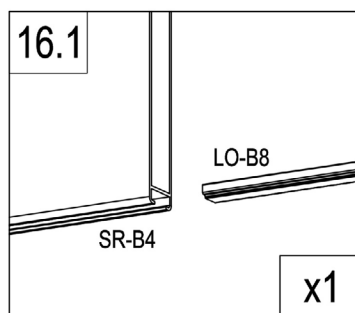
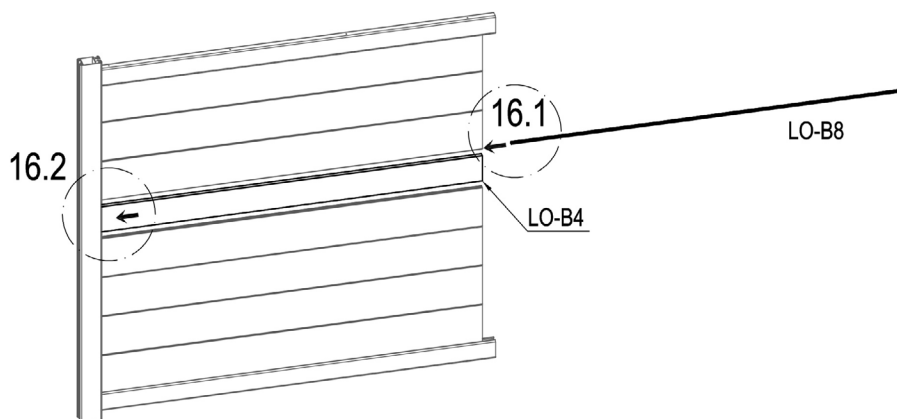

	SR-B4	3
---	-------	---

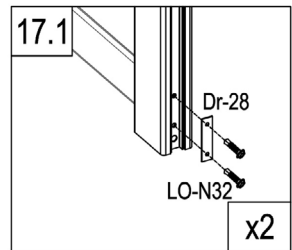
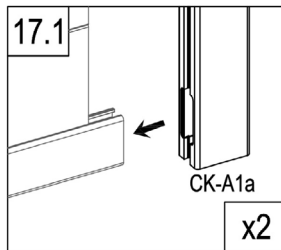
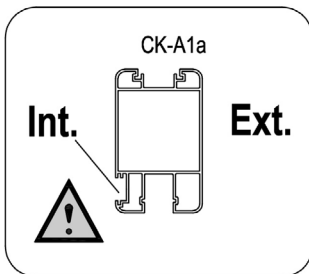
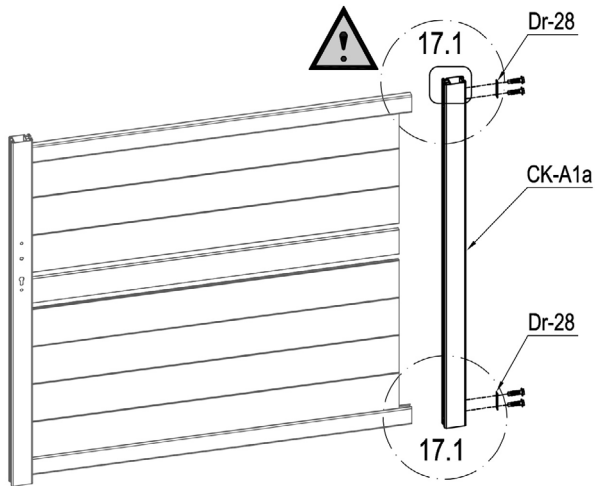

	LO-B4	1
	LO-B8	1



	CK-A1a	1
	Dr-28	2
	LO-N32	4

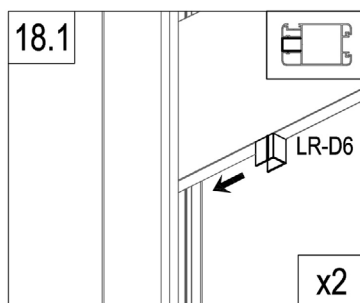
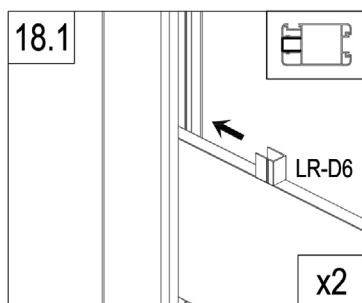
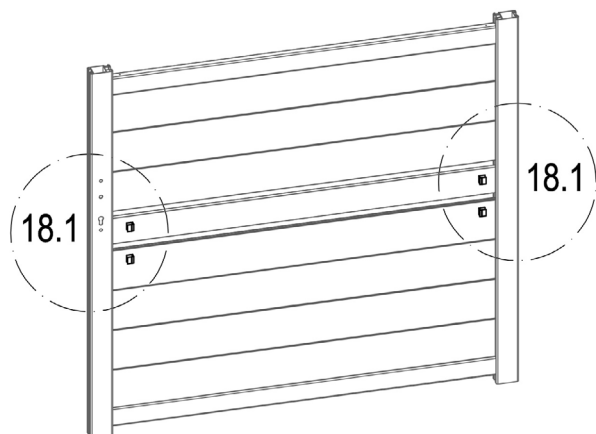

	LR-D6	4
---	-------	---



# CASANOVO

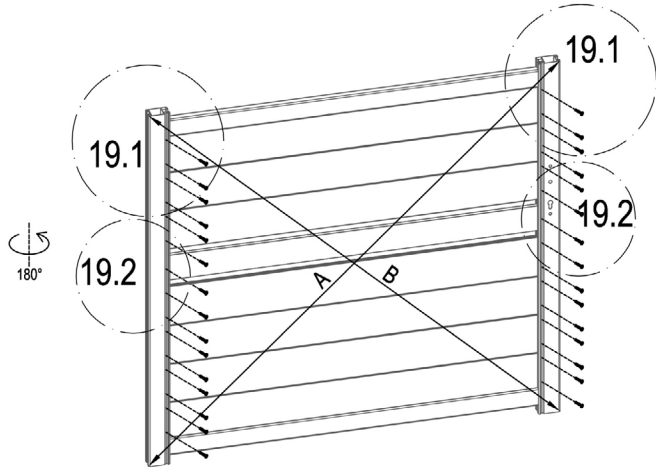

A=B

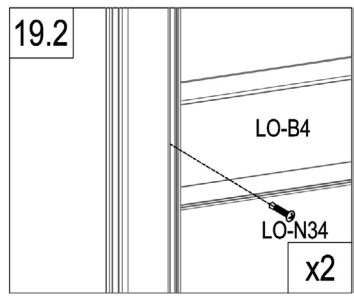
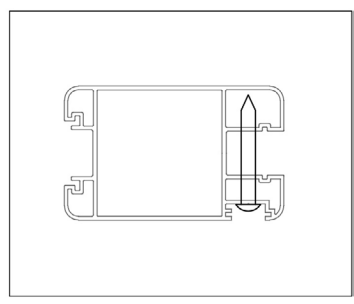
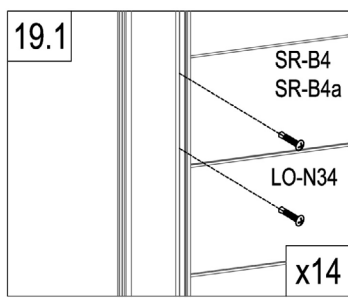

	LO-N34	30
---	--------	----

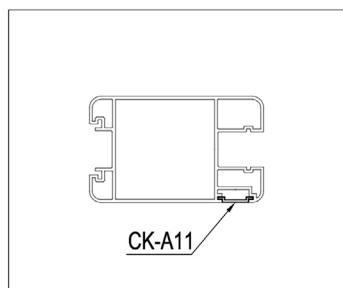
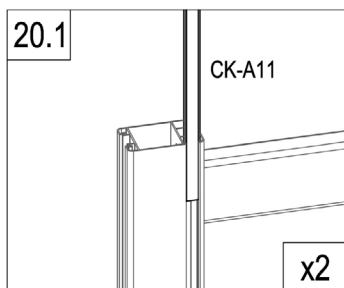
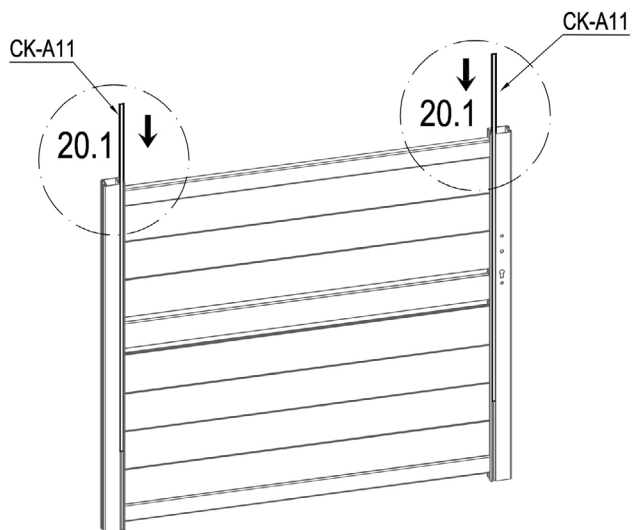

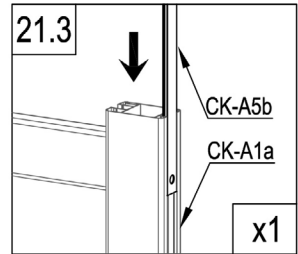
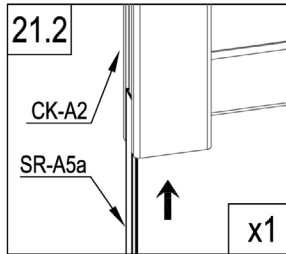
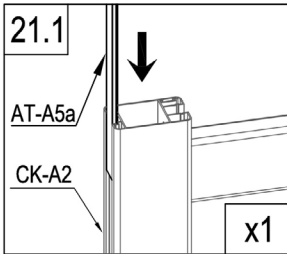
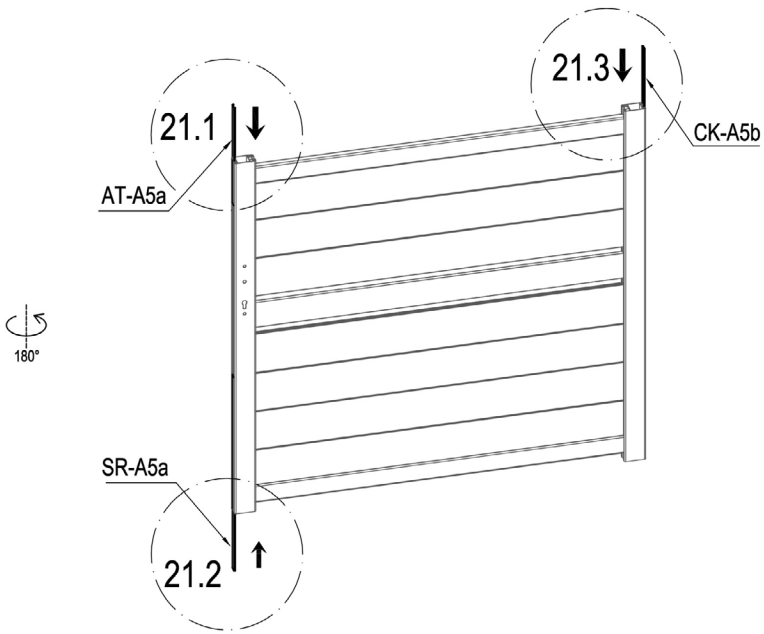

	CK-A11	2
---	--------	---

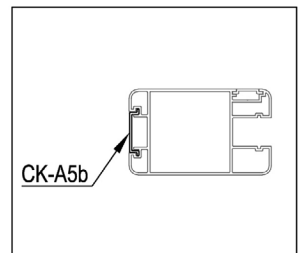

	CK-A5b	1
	AT-A5a	1
	SR-A5a	1

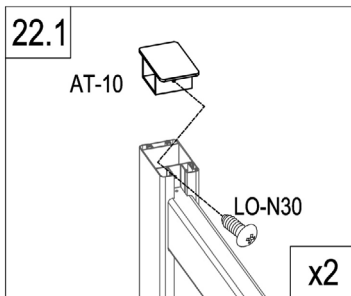
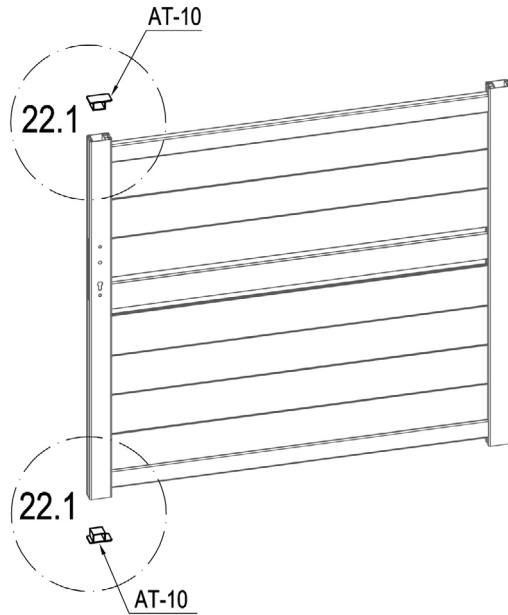



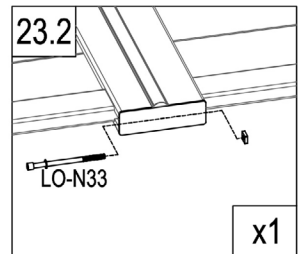
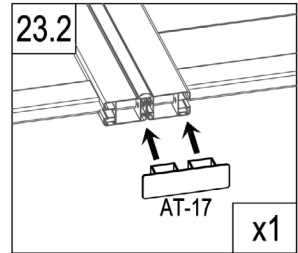
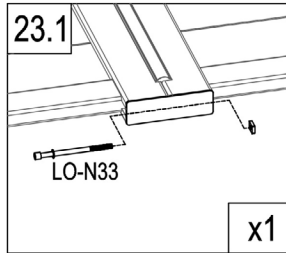
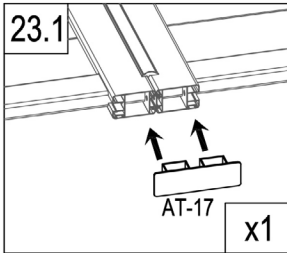
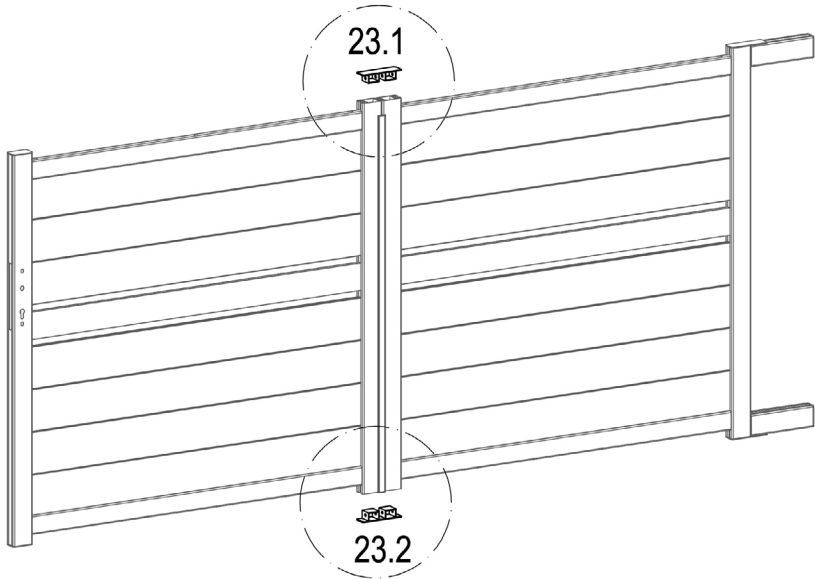

	AT-10	2
	LO-N30	2

# CASANOVA



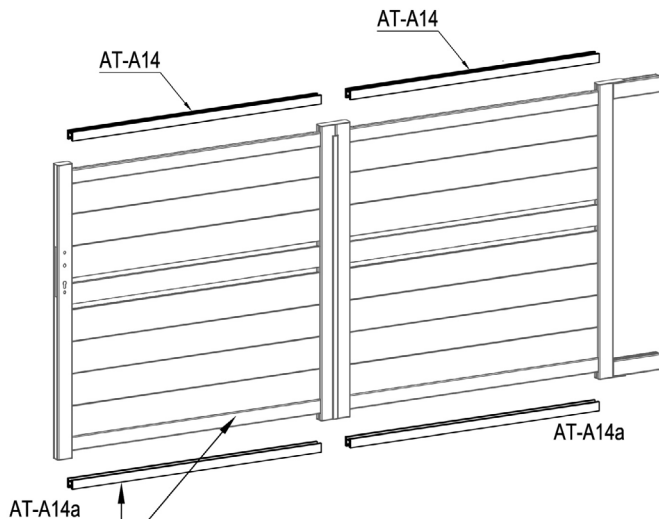

	AT-17	2
	LO-N33	2



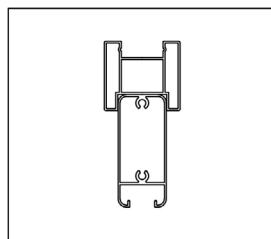
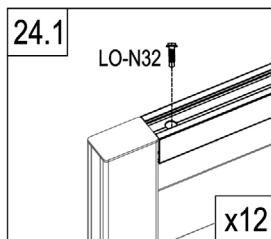
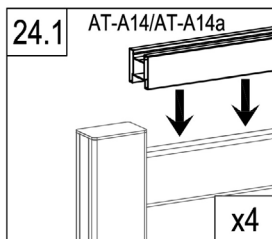

EN: These parts are made for connecting your gate's automation  
 FR: Ces pièces sont faites pour relier l'automatisation de votre portail  
 DE: Diese Teile sind für den Anschluss der Automatisierung Ihres Tores vorgesehen  
 ES: Estas piezas están hechas para conectar la automatización de su puerta  
 PT: Estas peças são feitas para ligar a automatização do seu portão  
 IT: Queste parti sono realizzate per collegare l'automazione del vostro cancello  
 NL: Deze onderdelen zijn gemaakt voor het aansluiten van de automatisering van uw poort.  
 PL: Te części są wykonane do podłączenia automatyki bramy.



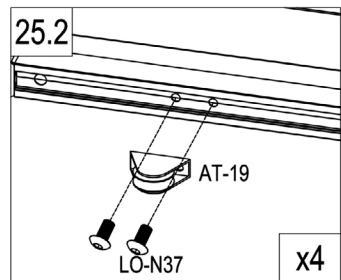
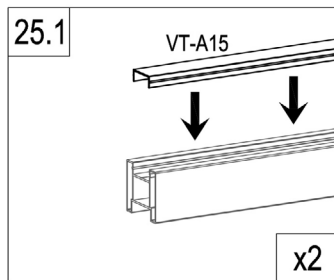
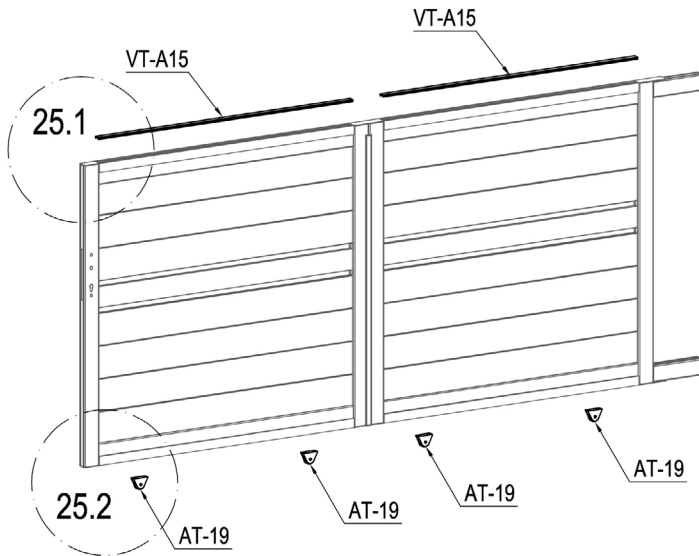

	AT-A14	2
	AT-A14a	2
	LO-N32	12

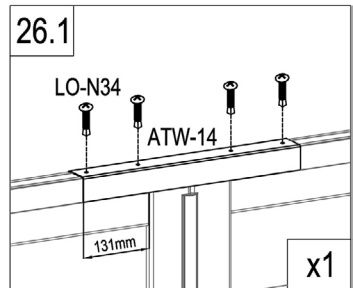
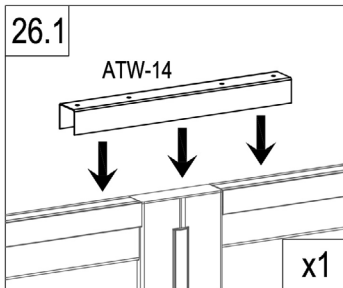
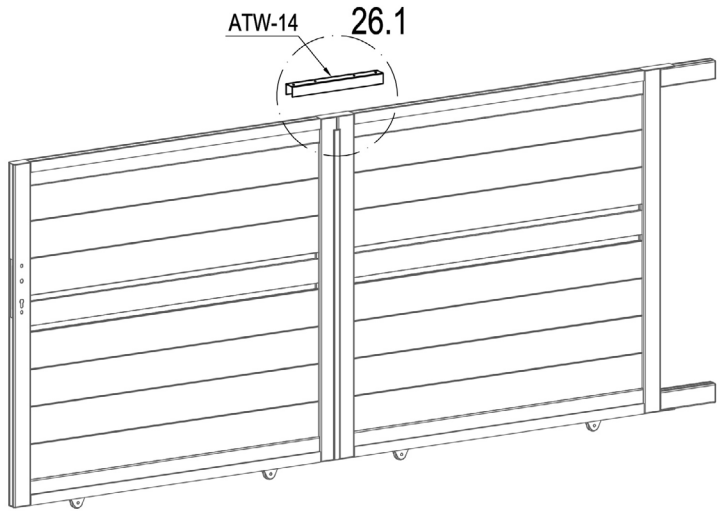

	VT-A15	2
	AT-19	4
	LO-N37	8



	ATW-14	1
	LO-N34	4



# CASANOVO

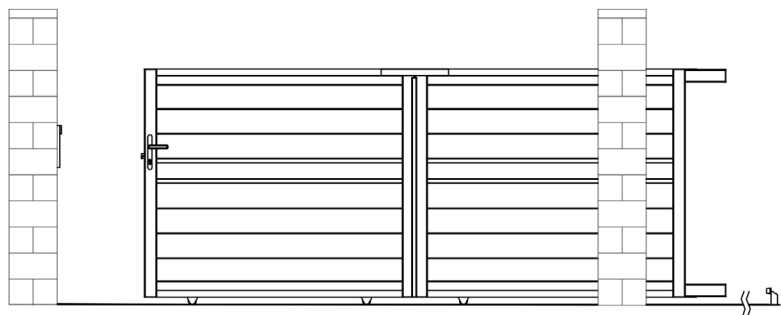

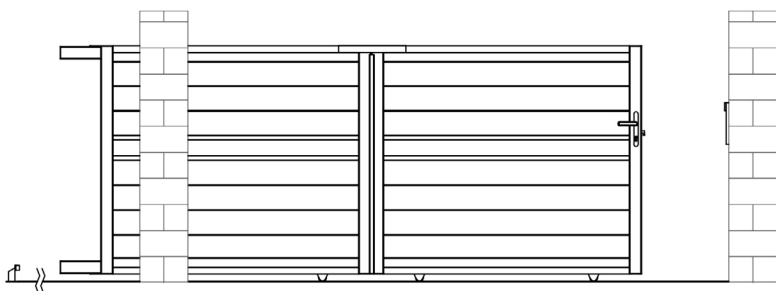

L

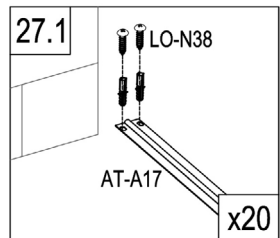
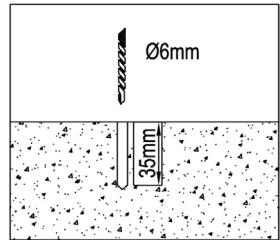
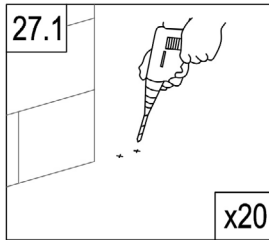
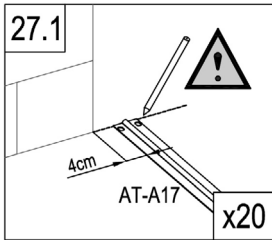
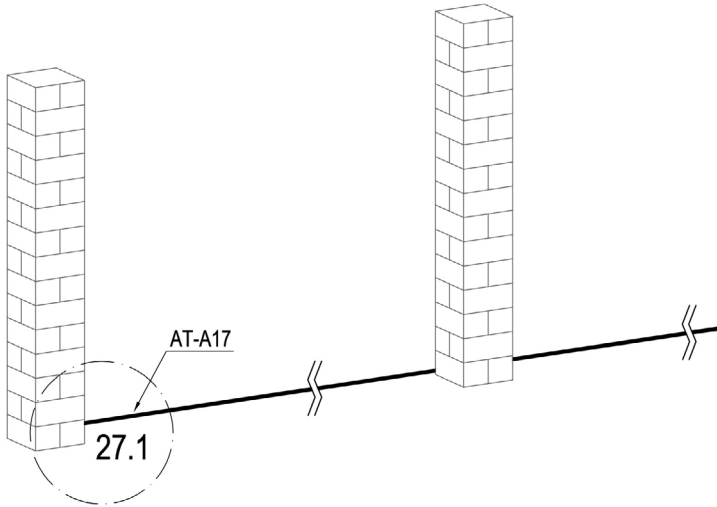

R

L



	AT-A17	5
	LO-N38	40

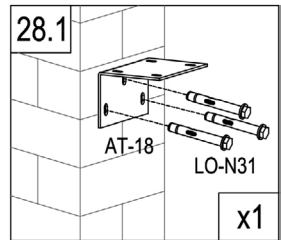
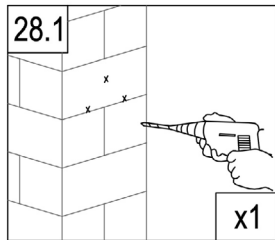
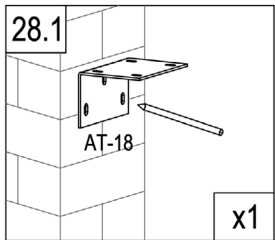
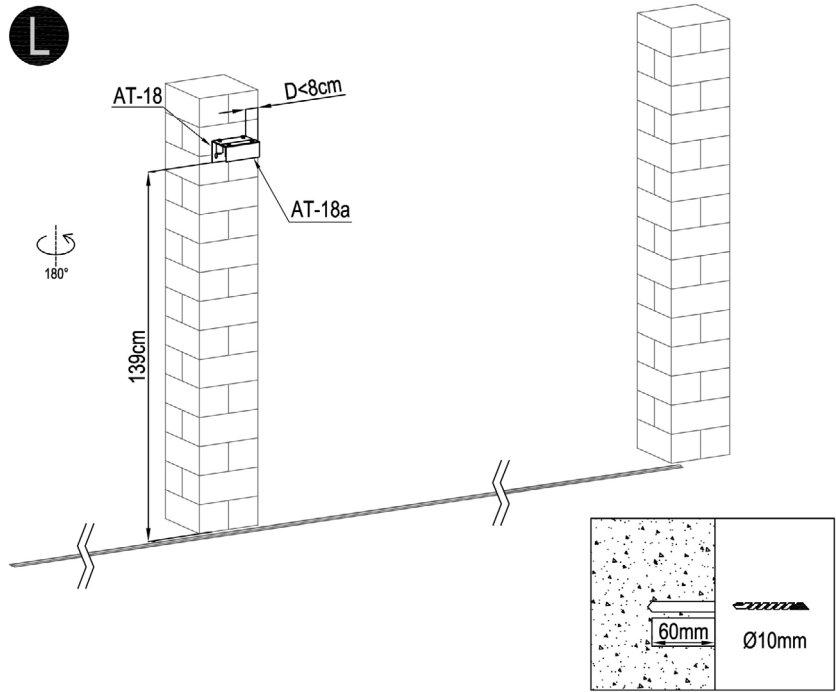

	AT-18	1
	AT-18a	1
	AT-20	4
	LO-N31	3

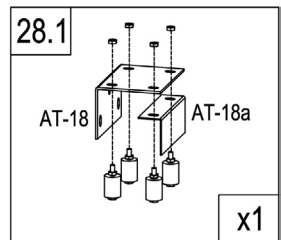
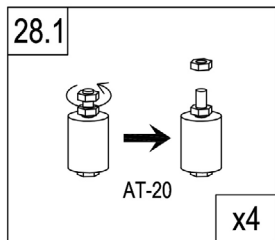

L

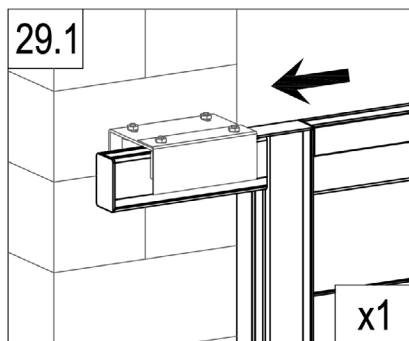
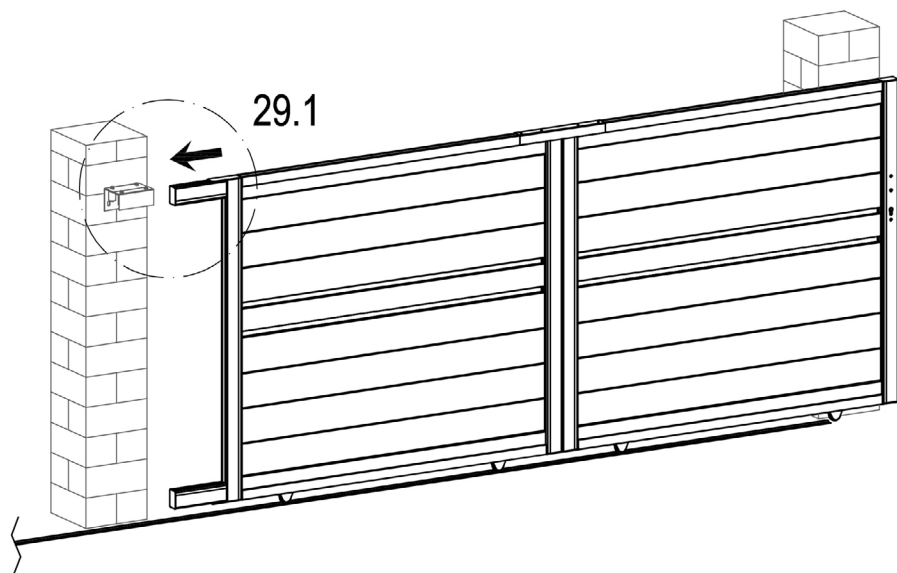

L

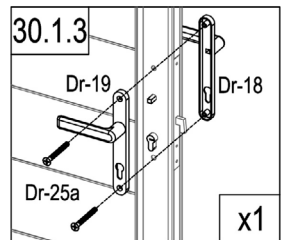
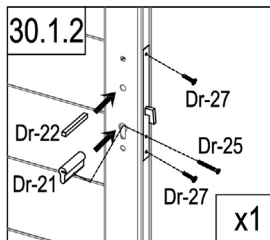
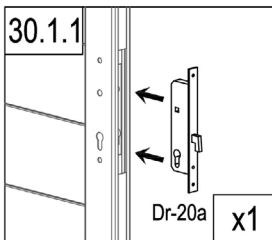
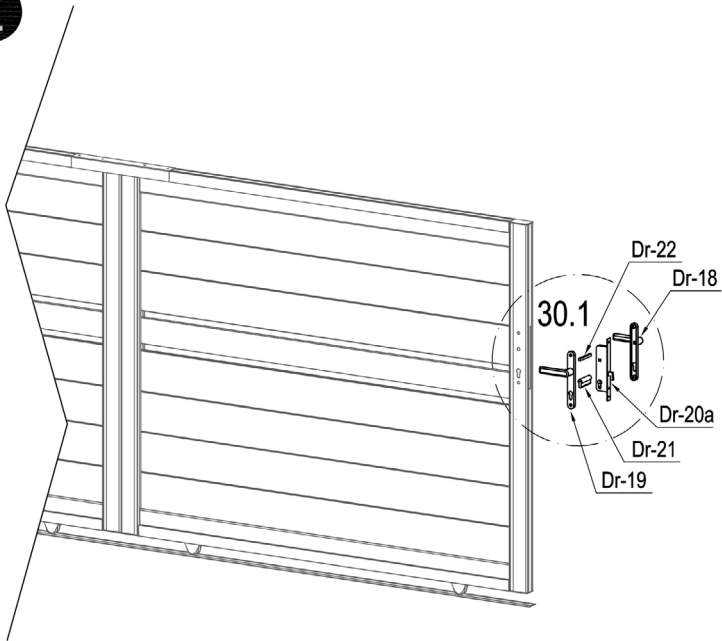

	Dr-20a	1
	Dr-21	1
	Dr-22	1
	Dr-25	1

	Dr-18	1
	Dr-19	1
	Dr-25a	2
	Dr-27	2

L

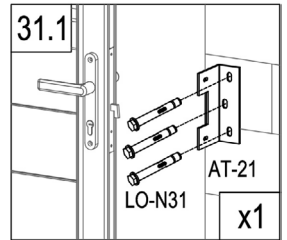
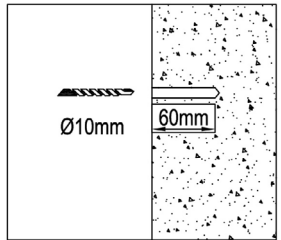
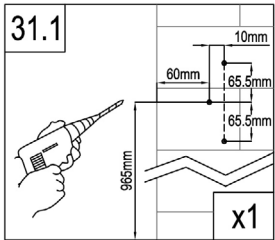
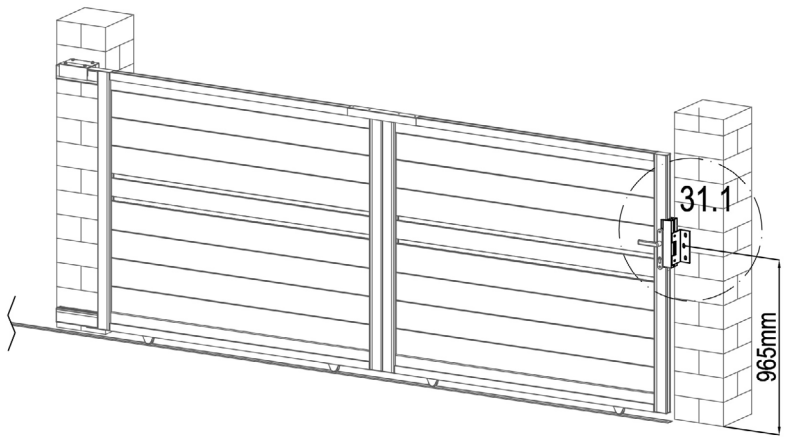

	AT-16	1
	AT-21	1
	LO-N36	2
	LO-N31	3
	AT-22J	3

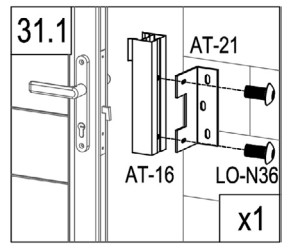
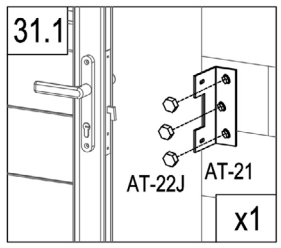

L

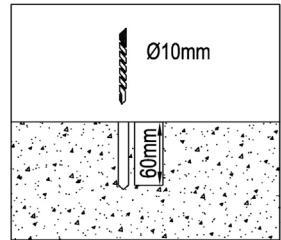
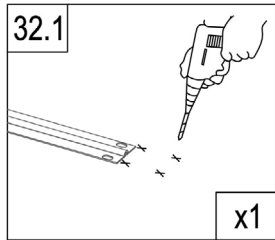
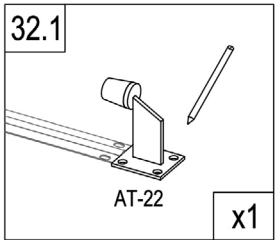
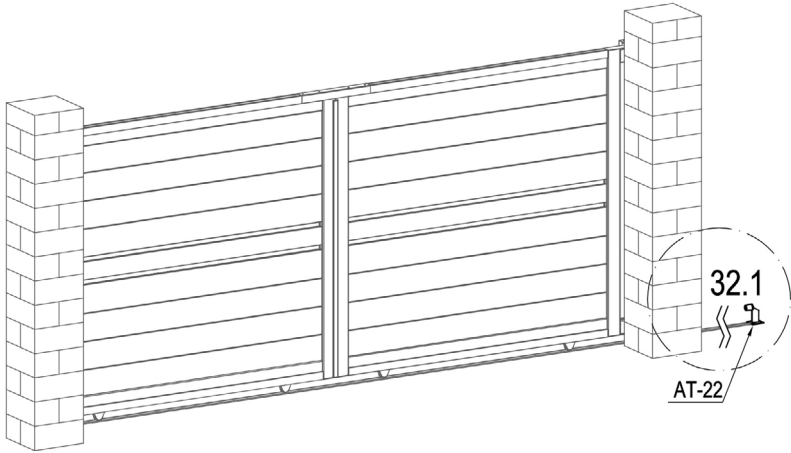

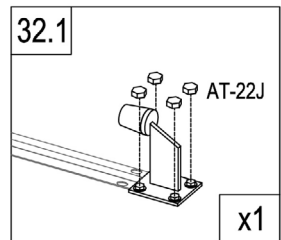
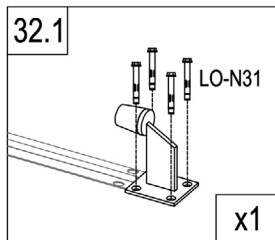

	AT-22	1
	LO-N31	4
	AT-22J	4

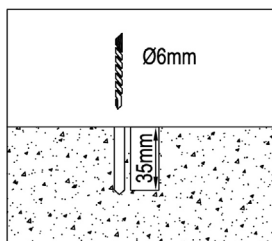
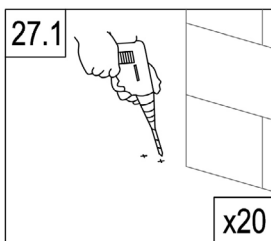
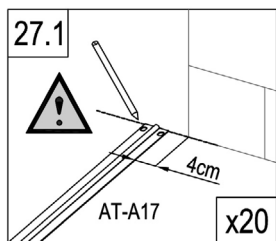
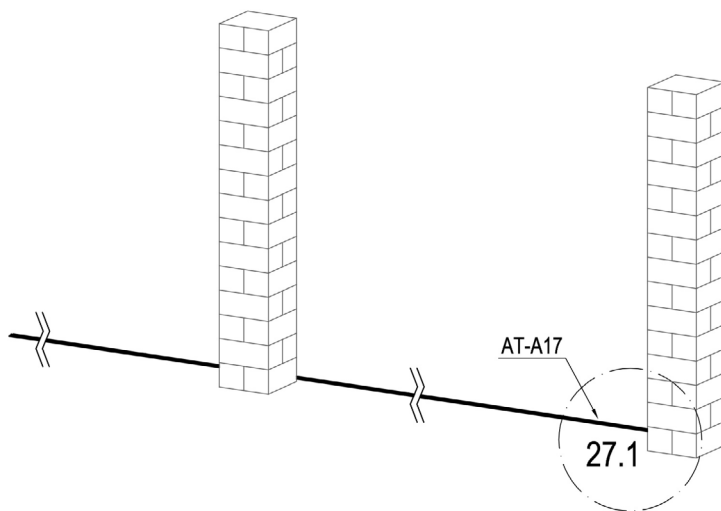

R



	AT-A17	5
	LO-N38	40

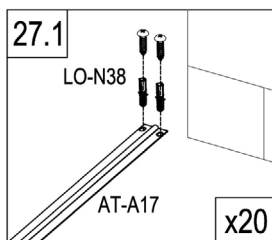



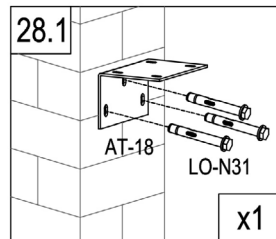
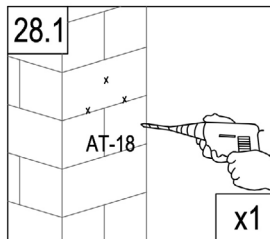
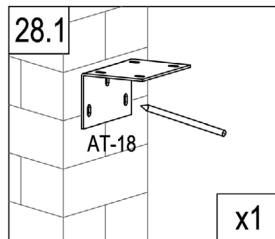
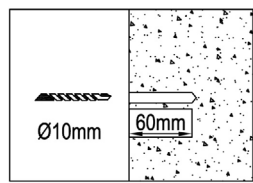
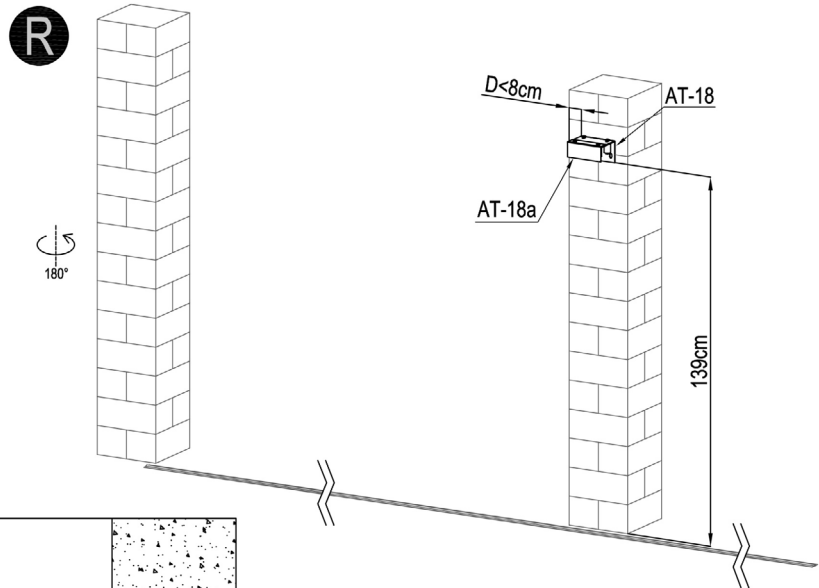

	AT-18	1
	AT-18a	1
	AT-20	4
	LO-N31	3

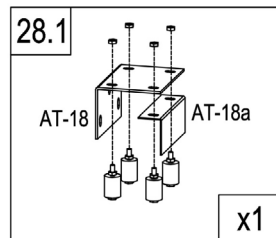
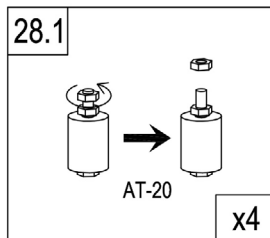

R

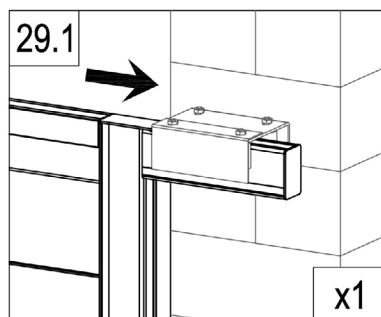
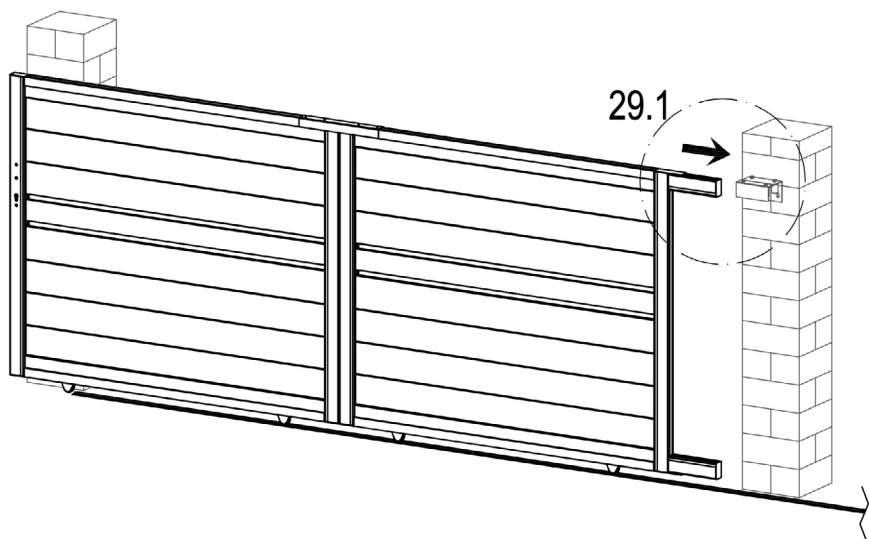

R

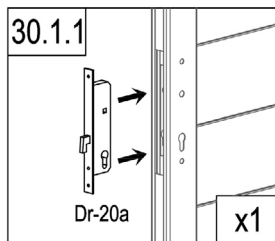
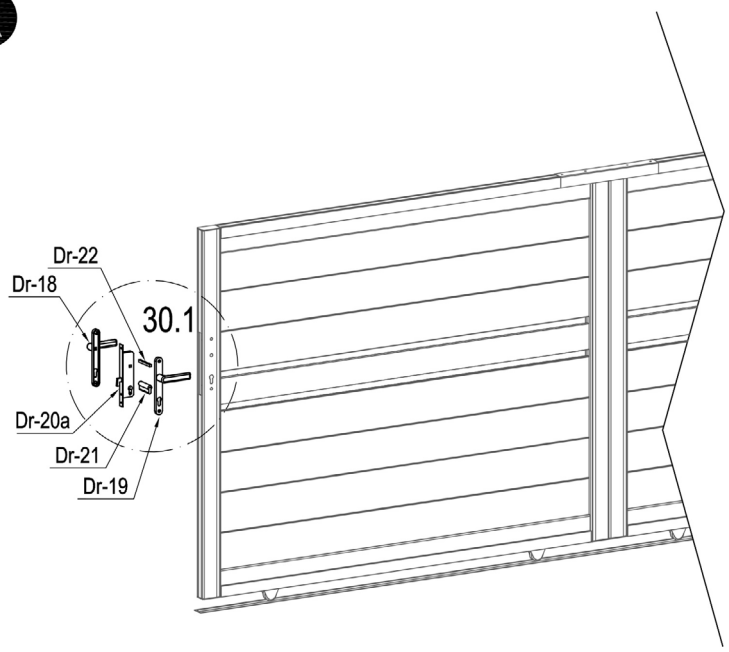

	Dr-20a	1
	Dr-21	1
	Dr-22	1
	Dr-25	1

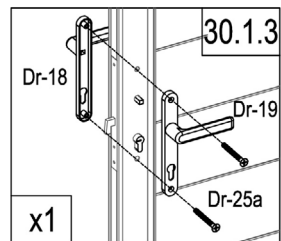
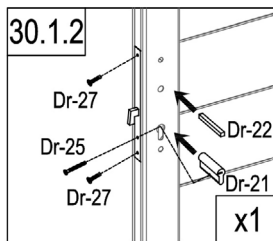

	Dr-18	1
	Dr-19	1
	Dr-25a	2
	Dr-27	2

R

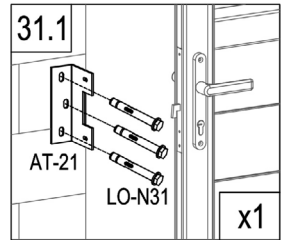
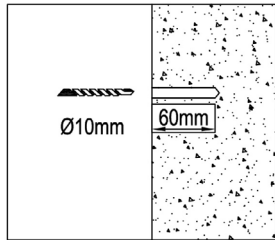
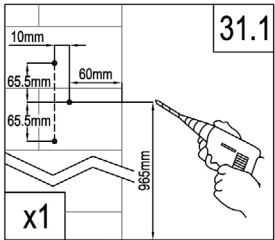
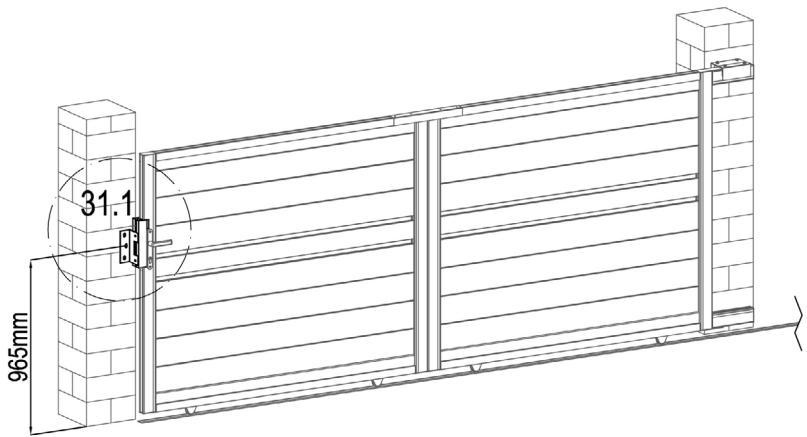

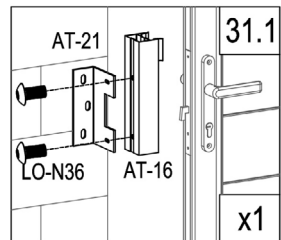
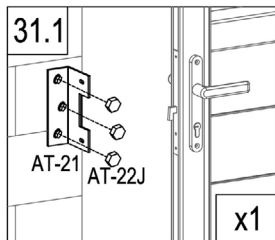

	AT-16	1
	AT-21	1
	LO-N36	2
	LO-N31	3
	AT-22J	3

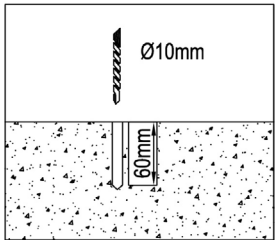
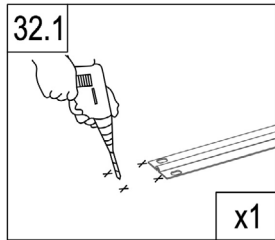
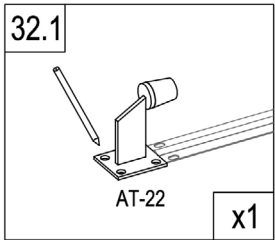
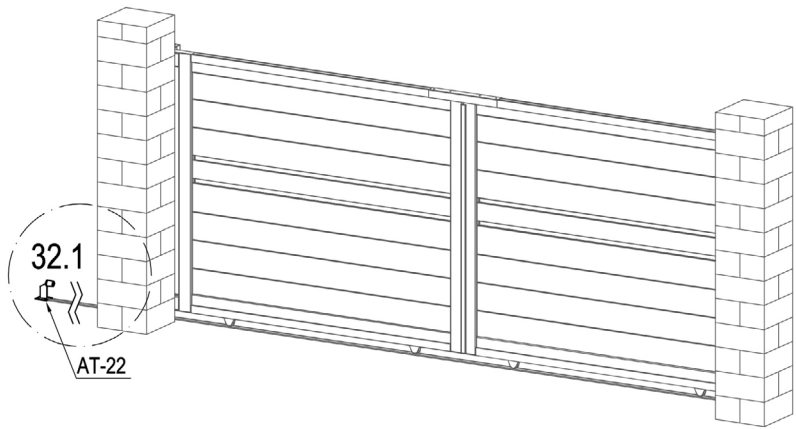

R



	AT-22	1
	LO-N31	4
	AT-22J	4

