

CASANOVO

SUNNY 500C160

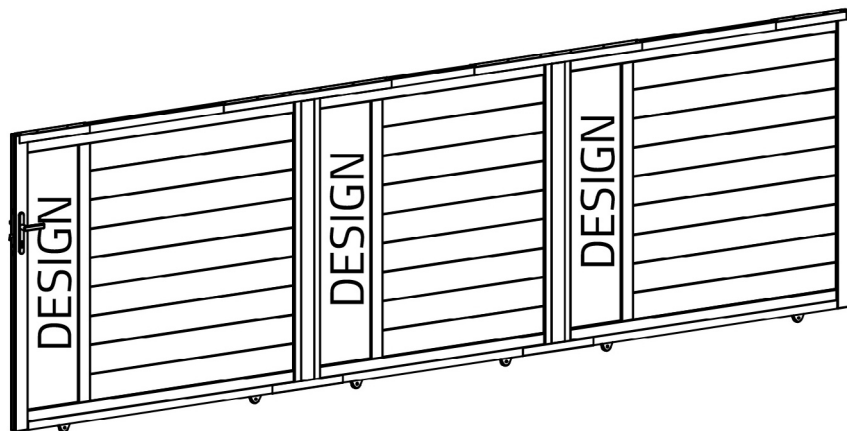

COM-001083 [x1]

COM-001085 [x1]

COM-000284 [x1]

COM-001084 [x1]

COM-001086 [x1]

COM-000286 [x1]



7-8H



X 2



INSTRUCTION MANUAL / NOTICE DE MONTAGE / MONTAGEANLEITUNG / MANUAL DE MONTAJE / MANUAL DE MONTAGEM / MANUALE DI MONTAGGIO /
MONTAGEHANDLEIDING / INSTRUKCJA MONTAŻU / KÄYTTÖOHJEET / BRUKSANVISNING / BRUGSANVISNING / INSTRUCȚIUNI DE ASAMBLARE /
NAVODILA ZA SESTAVLJANJE / NÁVOD NA MONTÁŽ / ÖSSZESZERELÉSI ÚTMUTATÓ / NÁVOD K MONTÁŽI / UPUTE ZA INSTALACIJU /
ΟΔΗΓΙΕΣ ΣΥΝΑΡΜΟΛΟΓΗΣΗΣ / SURINKIMO INSTRUKCIJOS / MONTĀŽAS INSTRUKCIJAS

Ext.

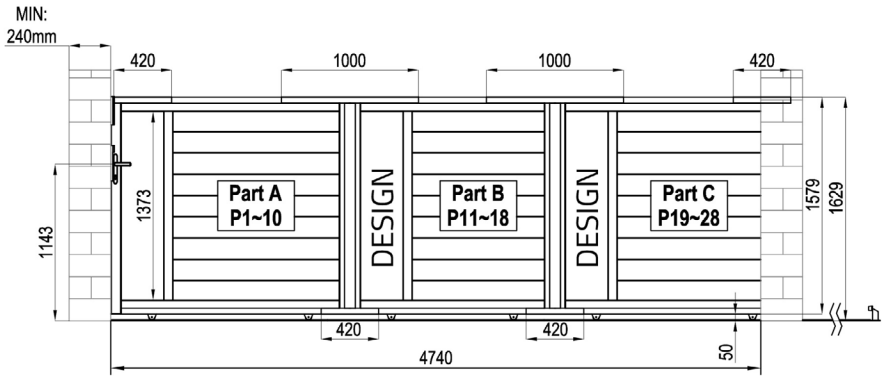

Int.

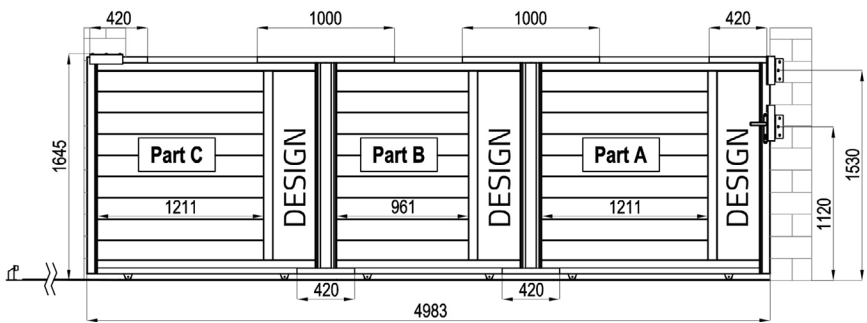

Part A.

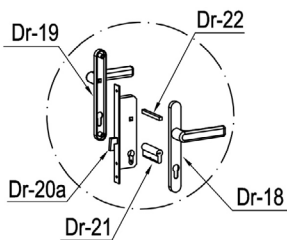
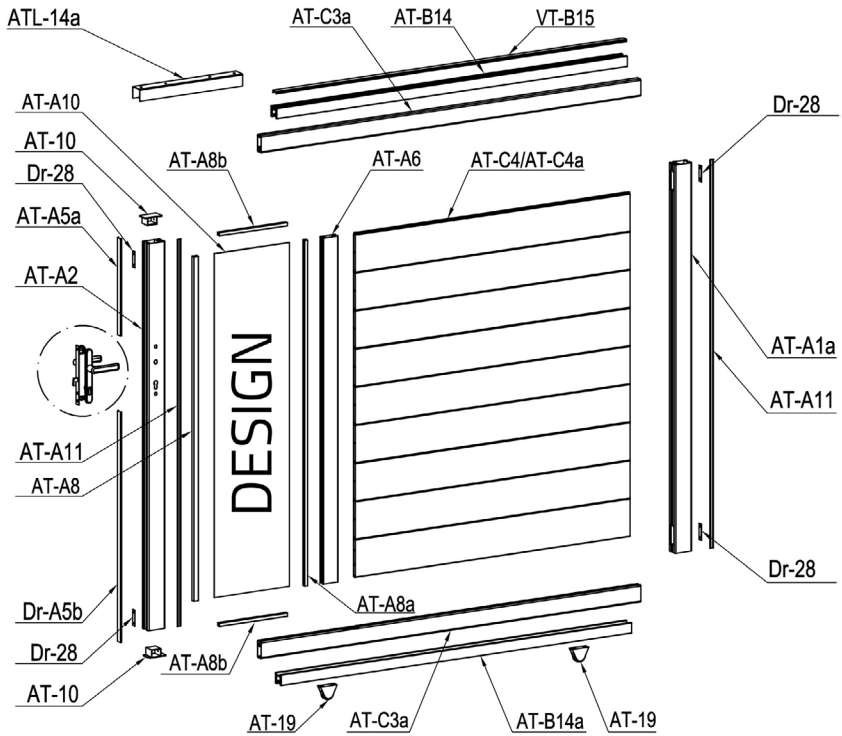

Part B.

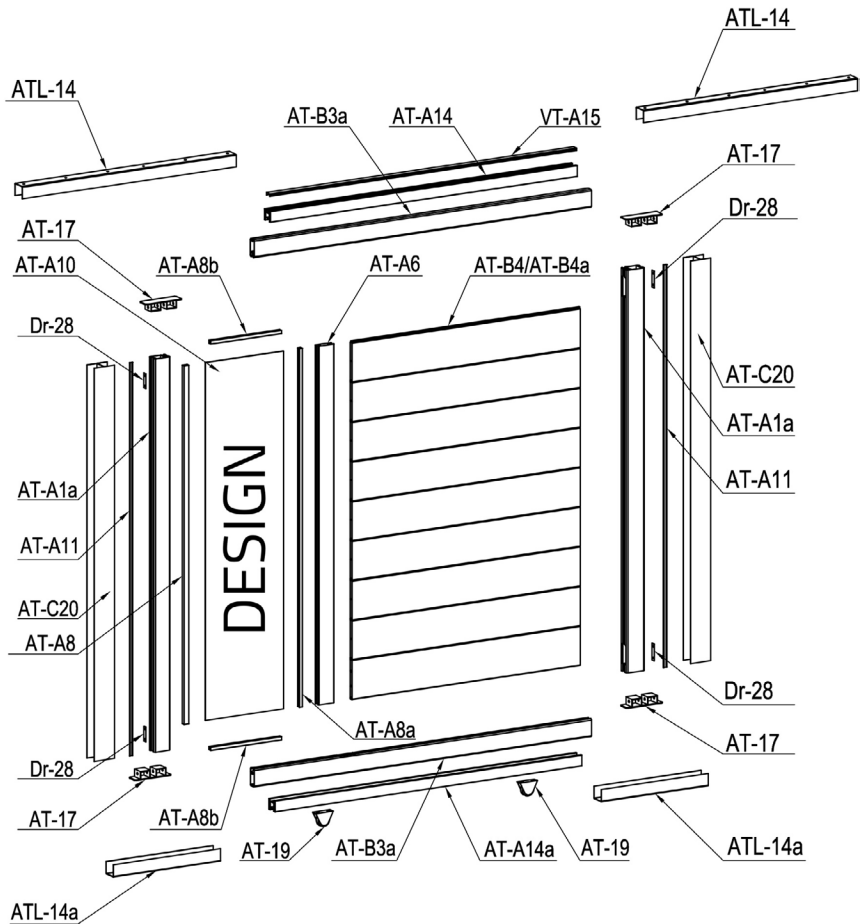

Part C.

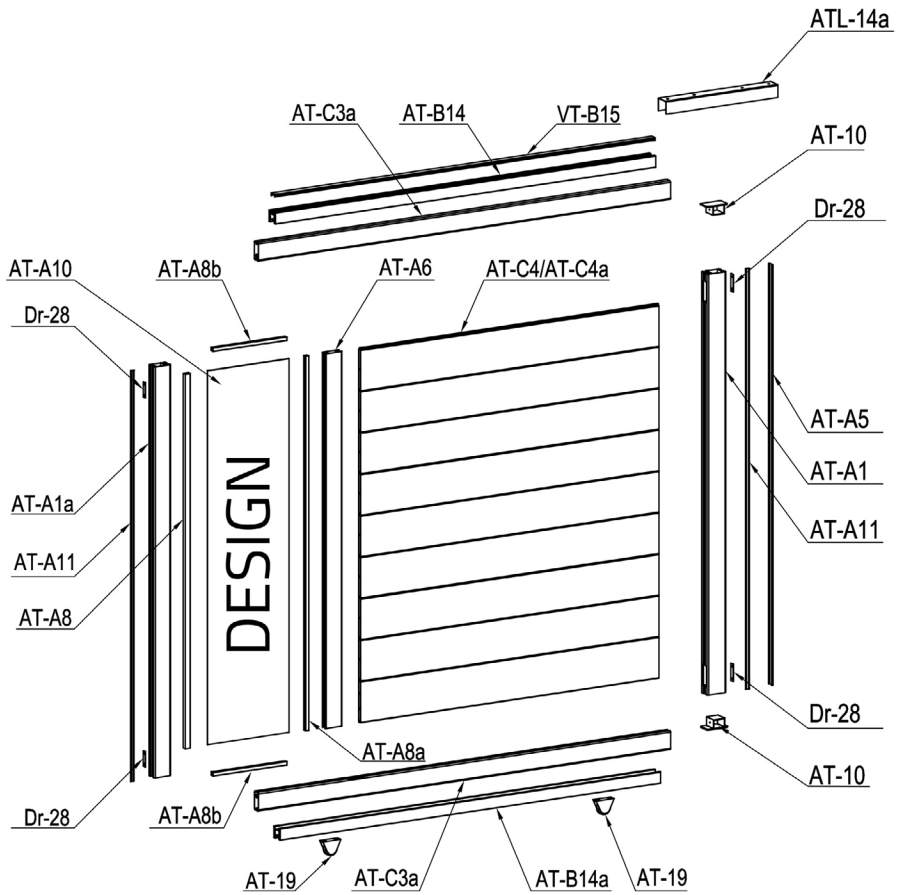

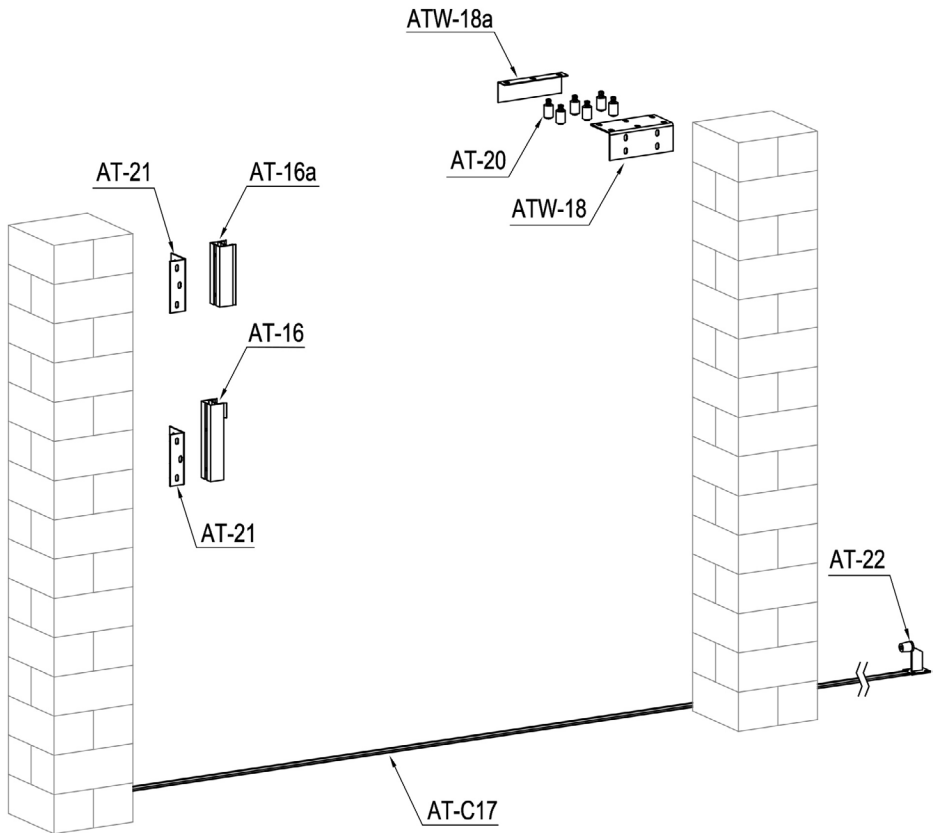



PART LIST

IMAGE	NO.	L.(mm)	QTY	IMAGE	NO.	L.(mm)	QTY
	AT-A1	1573	1		AT-C17	1580	6
	AT-A1a	1573	4		ATW-18		1
	AT-A2	1573	1		ATW-18a		1
	AT-B3a	1471	2		ATL-14	1000	2
	AT-C3a	1721	4		ATL-14a	420	4
	AT-A6	1401	3		AT-19		6
	AT-B4	995	8		AT-20		6
	AT-C4	1245	16		AT-21		2
	AT-B4a	995	1		AT-22		1
	AT-C4a	1245	2		Dr-18		1
	AT-A5	1573	1		Dr-19		1
	AT-A5a	395.5	1		Dr-20a		1
	Dr-A5b	937	1		Dr-21		1
	AT-A11	1573	6		Dr-22		1
	AT-A8	1400	3		Dr-25		1
	AT-A8a	1400	3		Dr-25a		2
	AT-A8b	308.5	6		Dr-27		2
	AT-A10	1398	3		Dr-28		12
	AT-C20	1493	2		AT-22J		10
	AT-A14	1338	1		AT-CP30	ST4x10	4
	AT-A14a	1338	1		AT-CP31	M8x60	14
	AT-B14	1588	2		AT-CP32	ST5.5x38	46
	AT-B14a	1588	2		AT-CP33	M8x130	4
	VT-A15	1337	1		AT-CP34	ST4.8x38	40
	VT-B15	1587	2		AT-CP35	ST4.2x19	81
	AT-16	260	1		AT-CP36	M6x20	4
	AT-16a	205	1		AT-CP37	M8x20	12
	AT-17		4		AT-CP38	ST4x25	60
	AT-10		4		AT-CP39	ST4.2x13	12

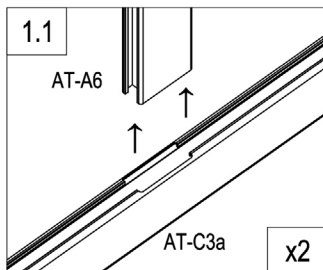
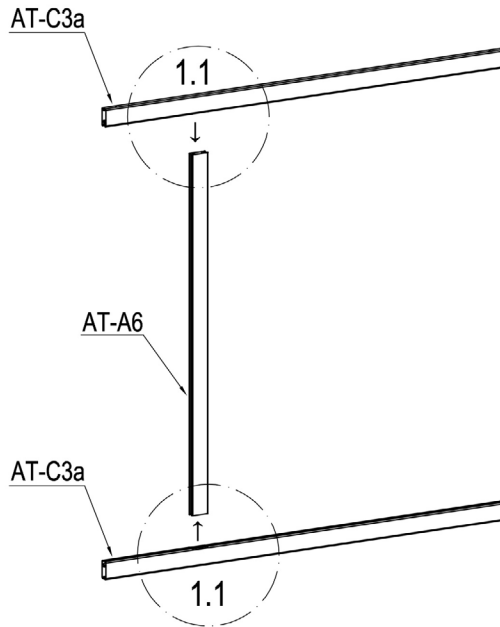
Part A.



	AT-A6	1
	AT-C3a	2

Part A.

EN :you can flip and switch the direction of this plate to personalize your gate

FR: vous pouvez retourner et changer la direction de cette plaque pour personnaliser votre portail

DE: Sie können dieses Schild umdrehen und die Richtung wechseln, um Ihr Tor zu personalisieren.

ES: puedes girar y cambiar la dirección de esta placa para personalizar tu puerta

PT: pode virar e mudar a direção desta placa para personalizar o seu portão

IT: potete capovolgere e cambiare la direzione di questa piastra per personalizzare il vostro cancello

NL: u kunt de richting van deze plaat omdraaien en veranderen om uw poort te verpersoonlijken...

PL: można obrócić i przełączyć kierunek tej płyty, aby spersonalizować bramę.

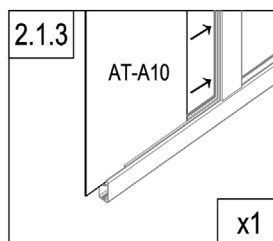
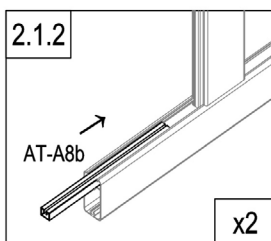
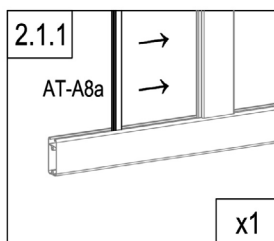
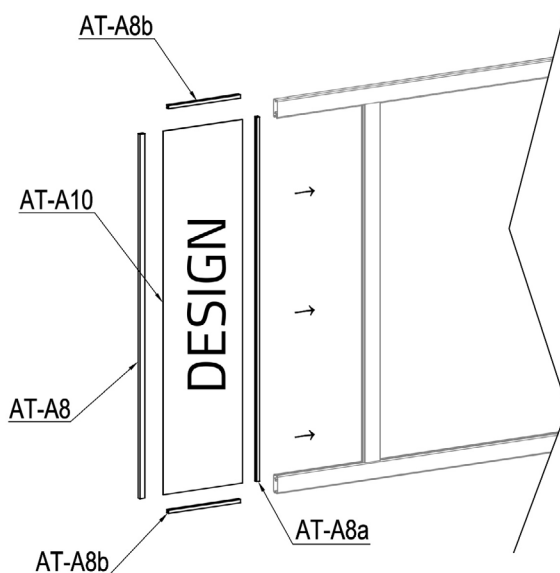

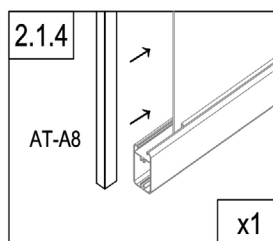

	AT-A8a	1
	AT-A8b	2
	AT-A10	1
	AT-A8	1



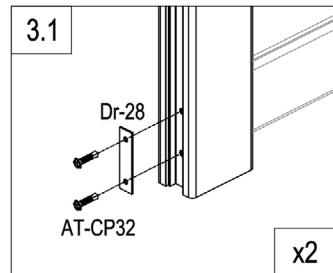
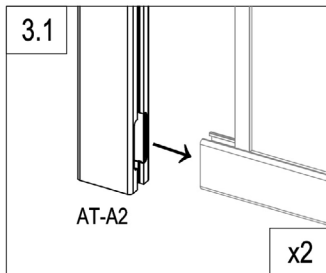
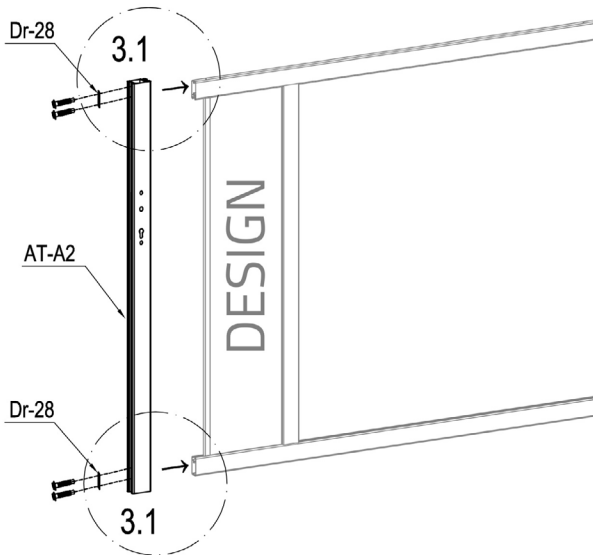

Part A.

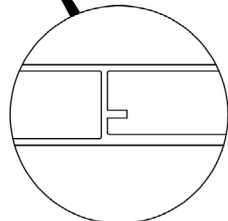
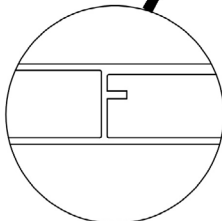
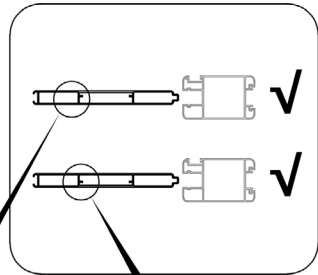
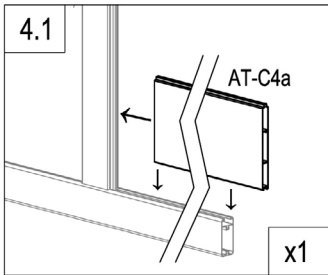
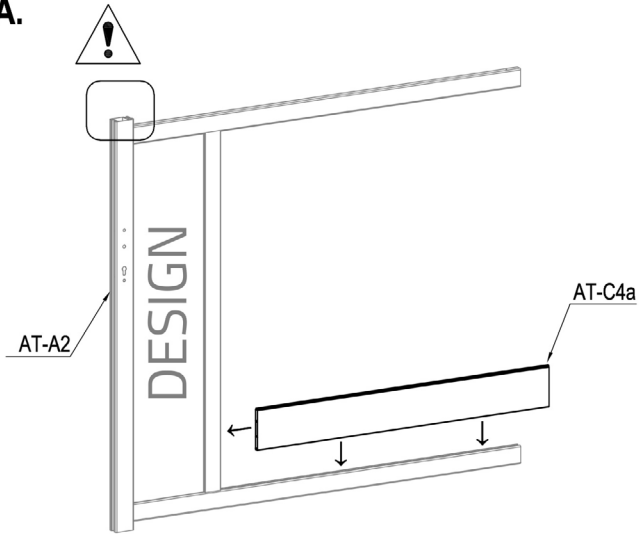

	AT-A2	1
	Dr-28	2
	AT-CP32	4

Part A.



	AT-C4a	1
---	--------	---

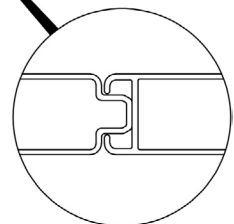
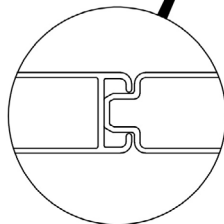
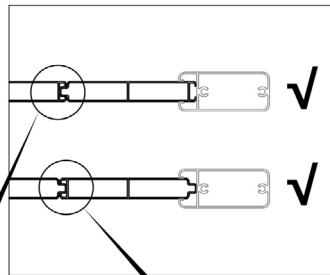
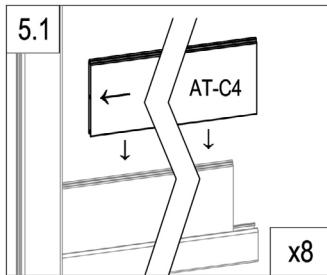
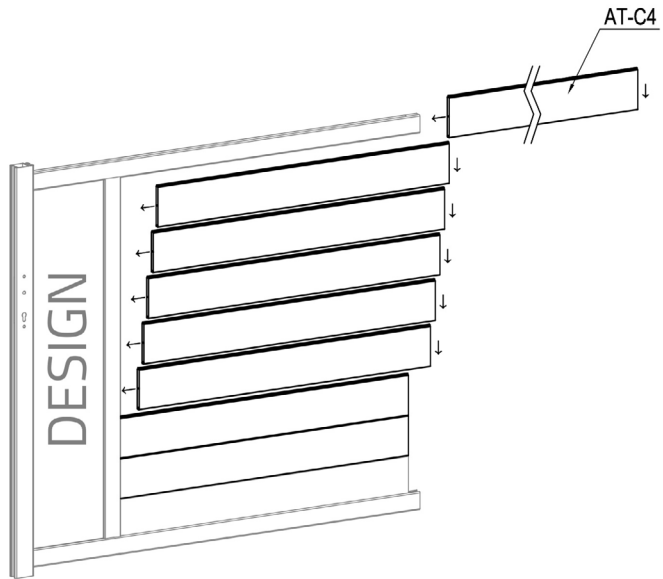

Part A.

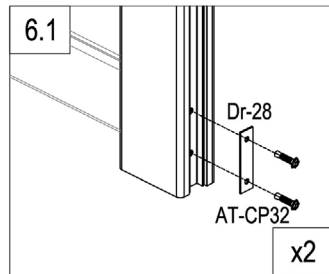
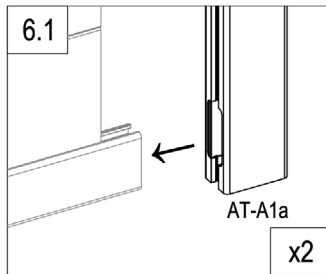
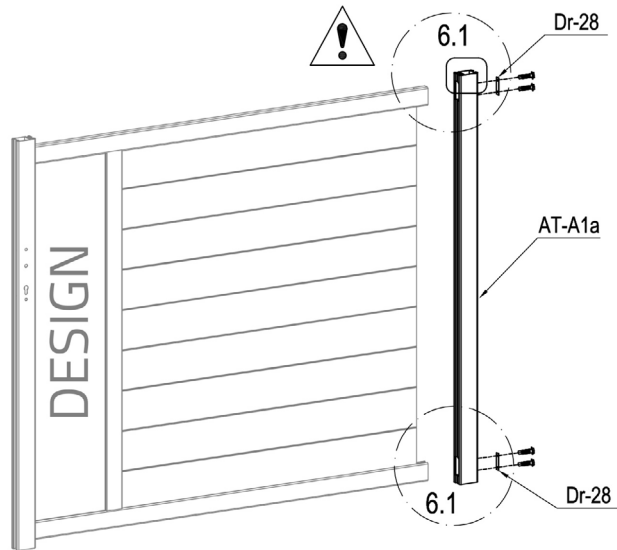

	AT-C4	8
---	-------	---

Part A.



	AT-A1a	1
	Dr-28	2
	AT-CP32	4

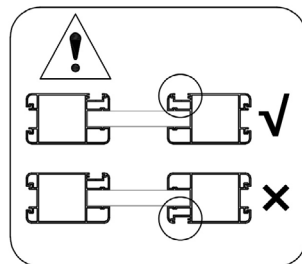

Part A.

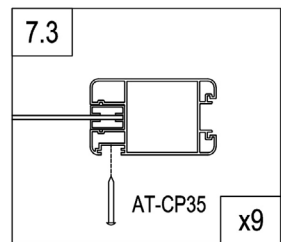
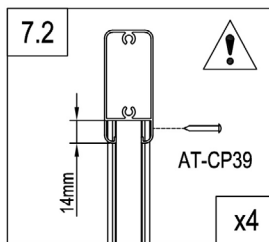
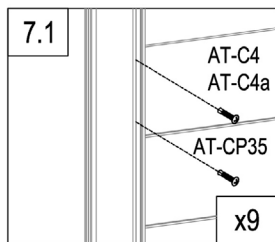
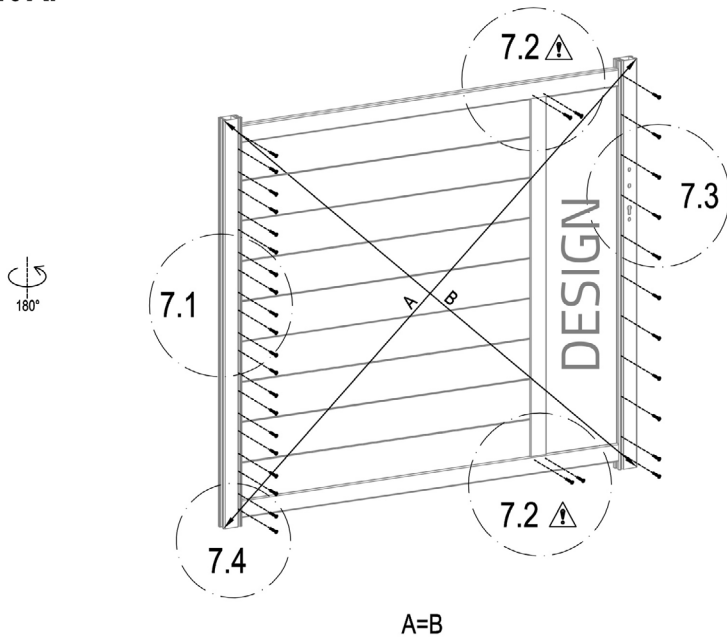

	AT-CP34	4
	AT-CP35	27
	AT-CP39	4

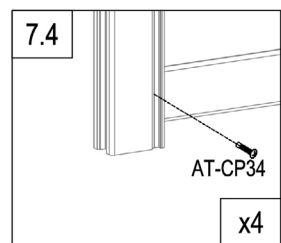

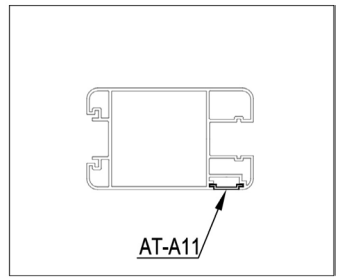
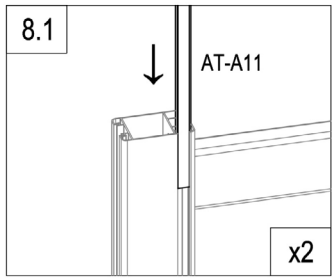
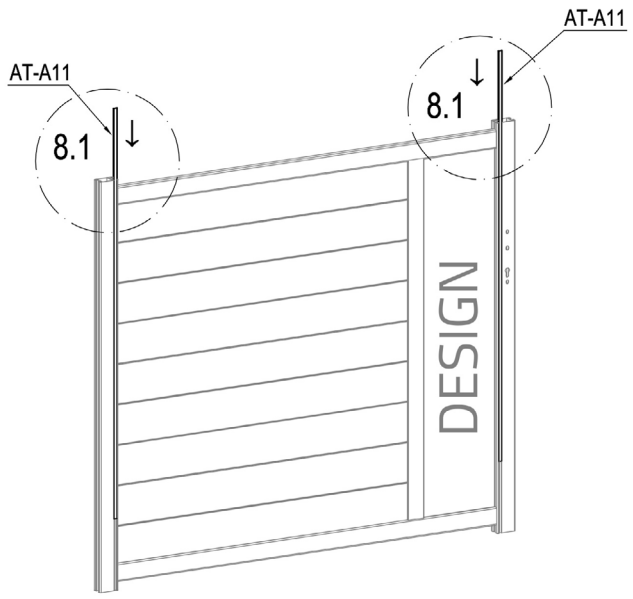

Part A.



	AT-A11	2
---	--------	---

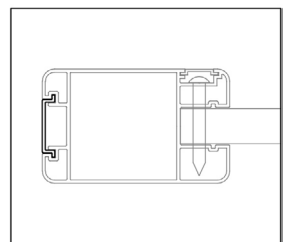
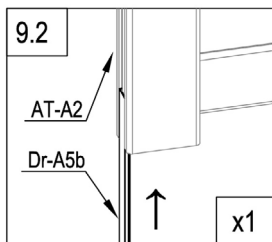
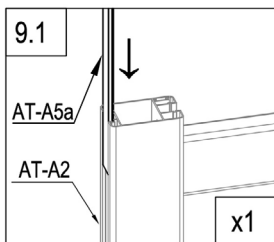
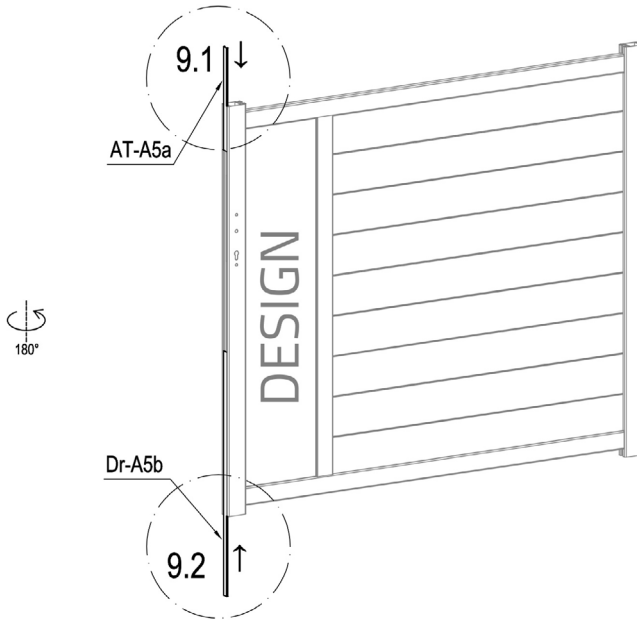

Part A.



	AT-A5a	1
	Dr-A5b	1

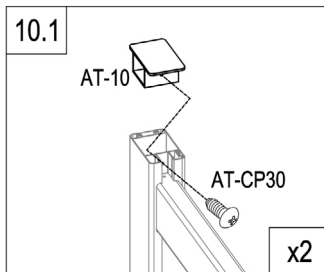
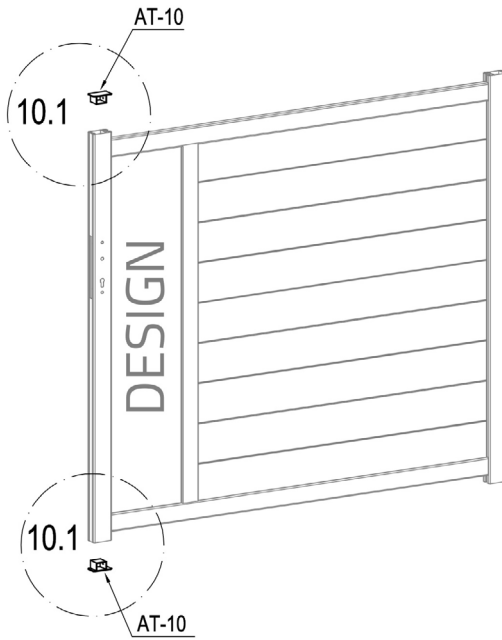

Part A.

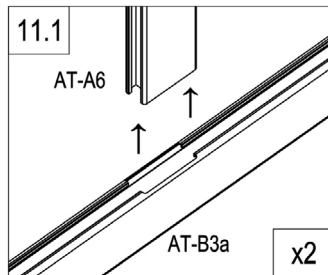
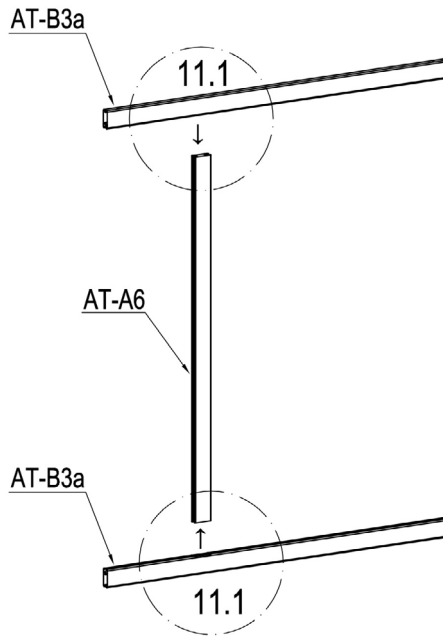

	AT-10	2
	AT-CP30	2

Part B.



	AT-A6	1
	AT-B3a	2

Part B.

EN :you can flip and switch the direction of this plate to personalize your gate

FR: vous pouvez retourner et changer la direction de cette plaque pour personnaliser votre portail

DE: Sie können dieses Schild umdrehen und die Richtung wechseln, um Ihr Tor zu personalisieren.

ES: puedes girar y cambiar la dirección de esta placa para personalizar tu puerta





PT: pode virar e mudar a direção desta placa para personalizar o seu portão

IT: potete capovolgere e cambiare la direzione di questa piastra per personalizzare il vostro cancello

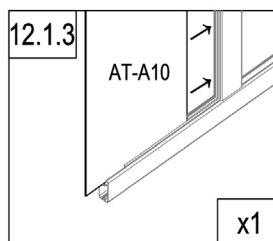
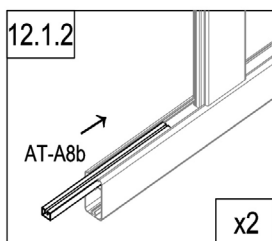
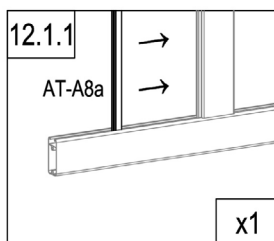
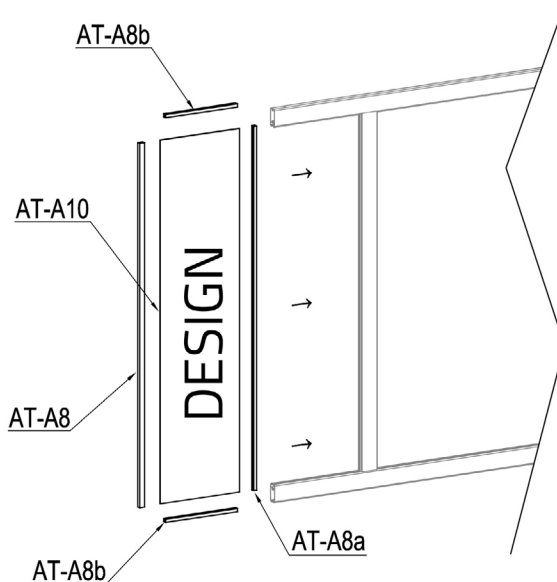
NL: u kunt de richting van deze plaat omdraaien en veranderen om uw poort te verpersoonlijken...

PL: można obrócić i przełączyć kierunek tej płyty, aby spersonalizować bramę.



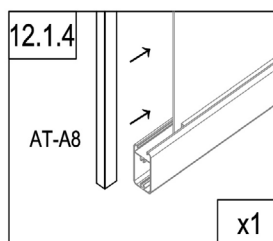

	AT-A8a	1
	AT-A8b	2
	AT-A10	1
	AT-A8	1

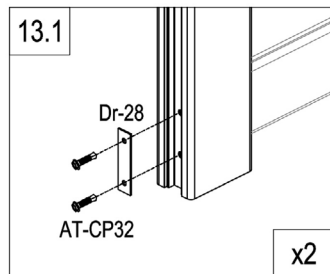
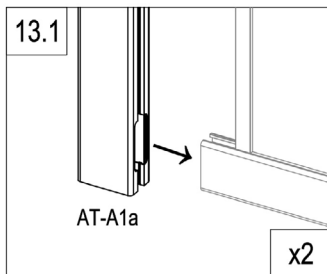
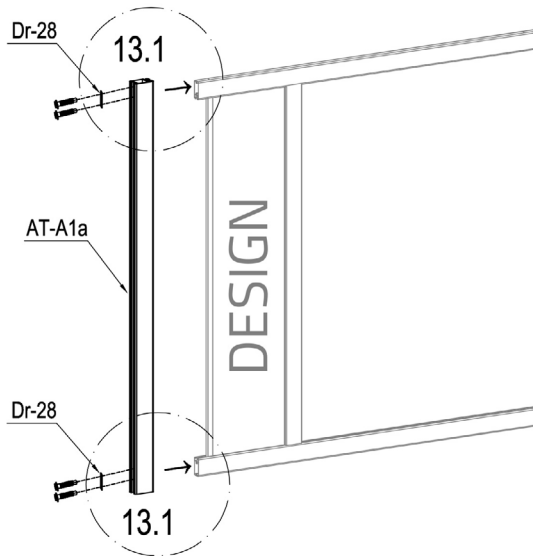

Part B.



	AT-A1a	1
	Dr-28	2
	AT-CP32	4

Part B.

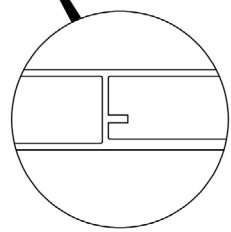
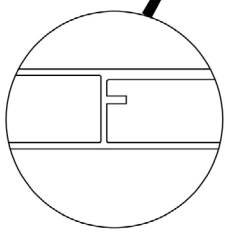
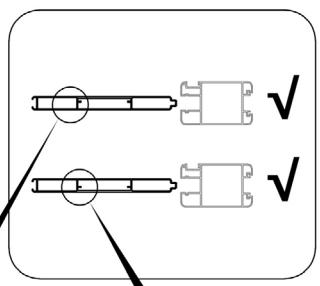
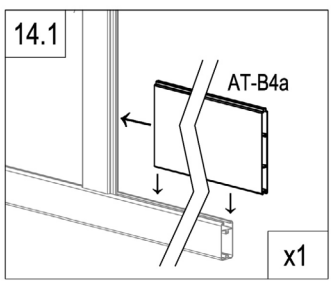
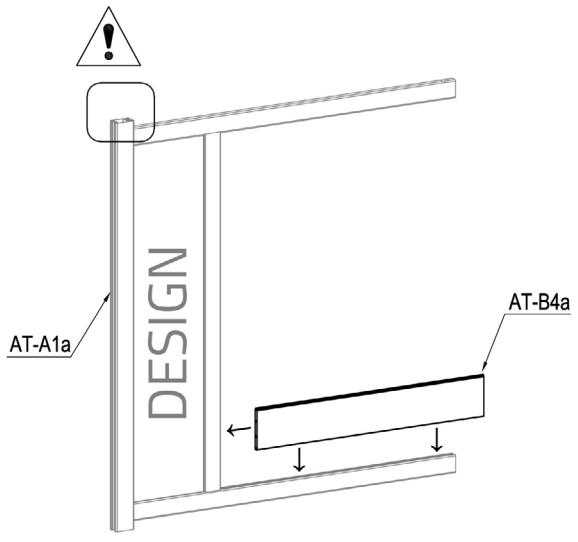

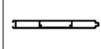
	AT-B4a	1
---	--------	---

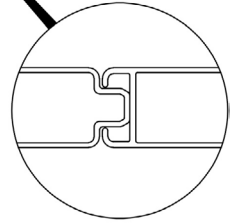
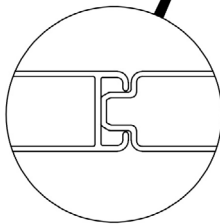
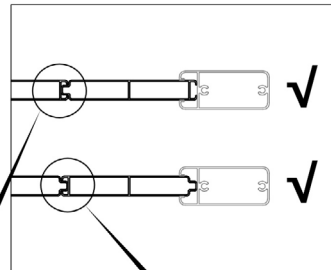
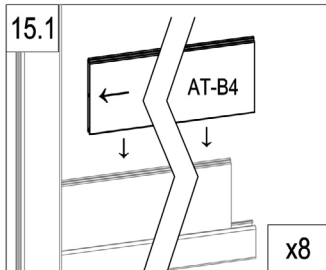
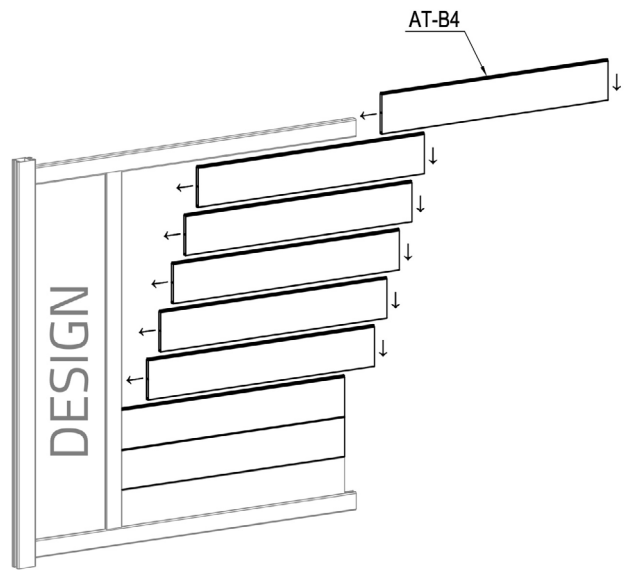

Part B.

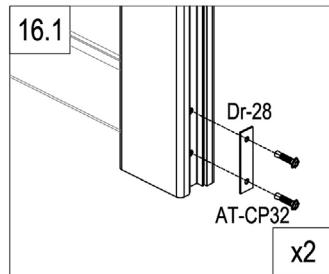
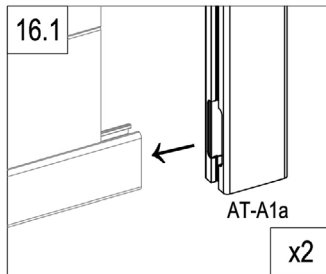
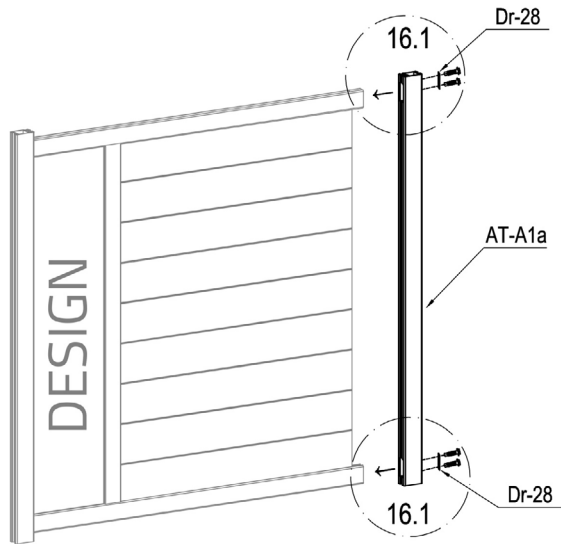

	AT-B4	8
---	-------	---

Part B.



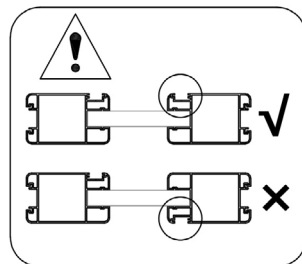

	AT-A1a	1
	Dr-28	2
	AT-CP32	4

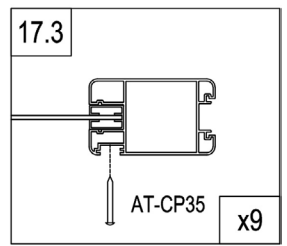
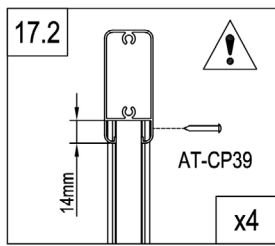
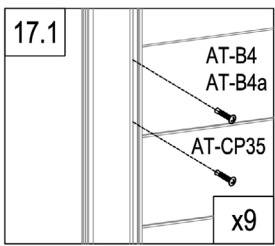
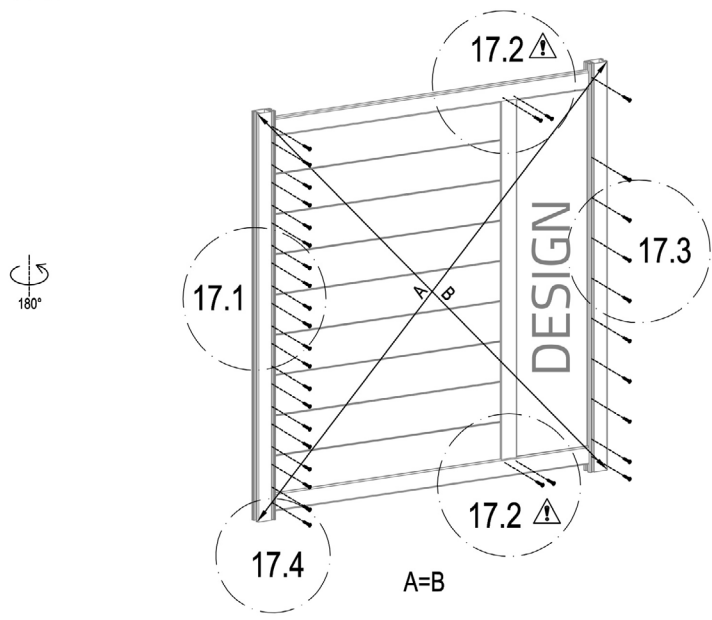

Part B.



	AT-CP34	4
	AT-CP35	27
	AT-CP39	4

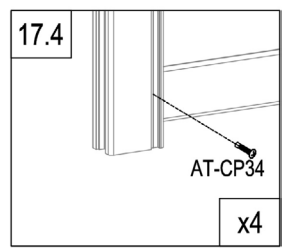

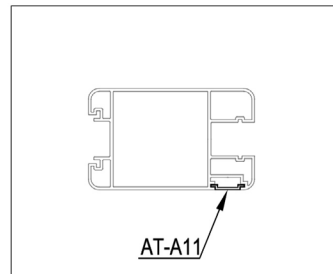
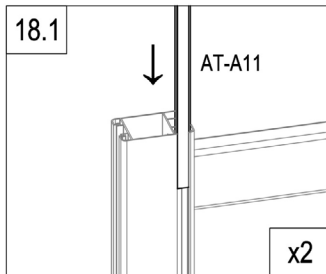
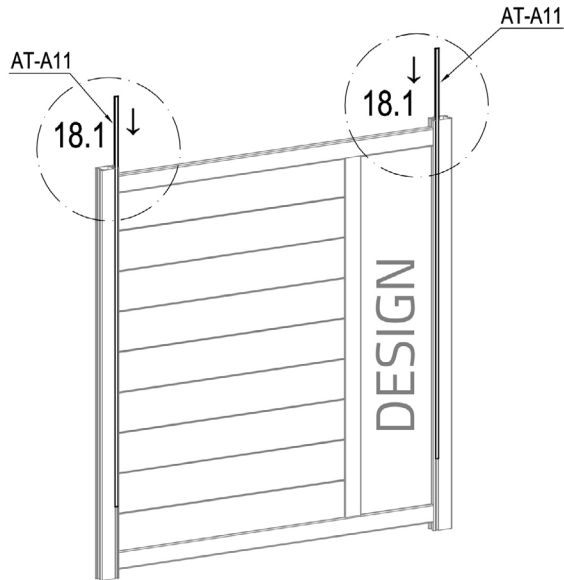

Part B.

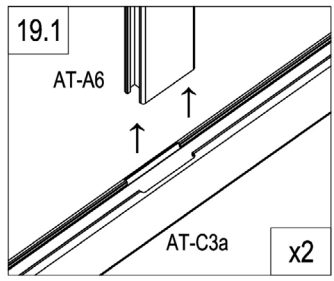
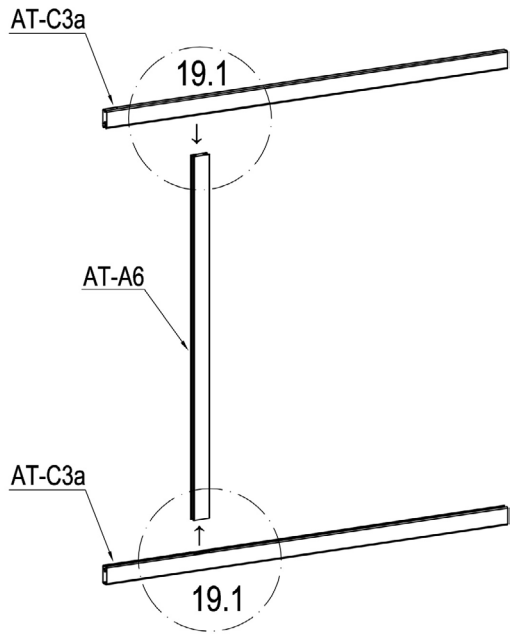

	AT-A11	2
---	--------	---

Part C.



	AT-A6	1
	AT-C3a	2

Part C.

EN :you can flip and switch the direction of this plate to personalize your gate

FR: vous pouvez retourner et changer la direction de cette plaque pour personnaliser votre portail

DE: Sie können dieses Schild umdrehen und die Richtung wechseln, um Ihr Tor zu personalisieren.

ES: puedes girar y cambiar la dirección de esta placa para personalizar tu puerta





PT: pode virar e mudar a direção desta placa para personalizar o seu portão

IT: potete capovolgere e cambiare la direzione di questa piastra per personalizzare il vostro cancello

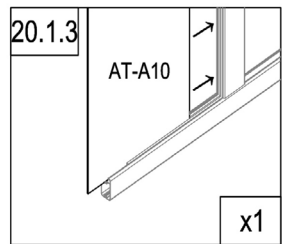
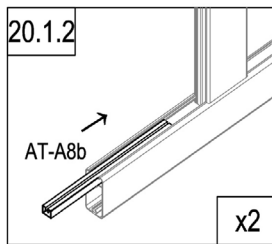
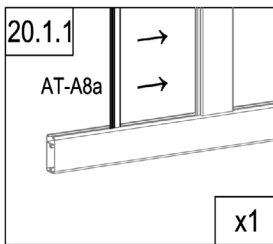
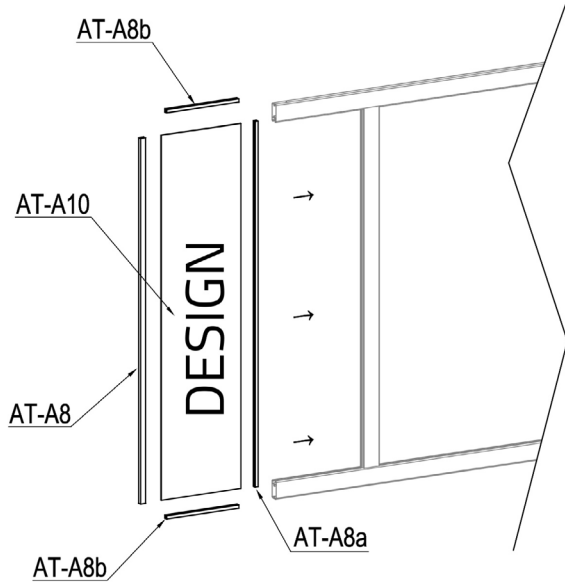
NL: u kunt de richting van deze plaat omdraaien en veranderen om uw poort te verspersonlijken...

PL: można obrócić i przełączyć kierunek tej płyty, aby personalizować bramę.



	AT-A8a	1
	AT-A8b	2
	AT-A10	1
	AT-A8	1

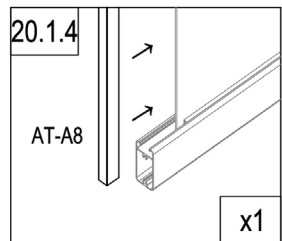

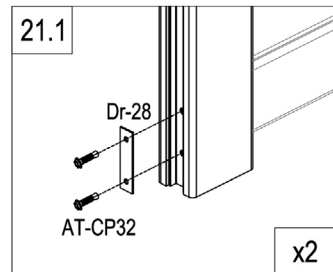
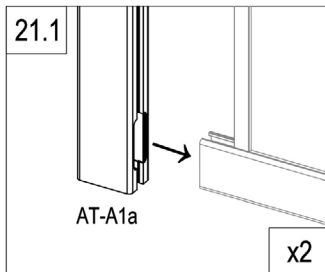
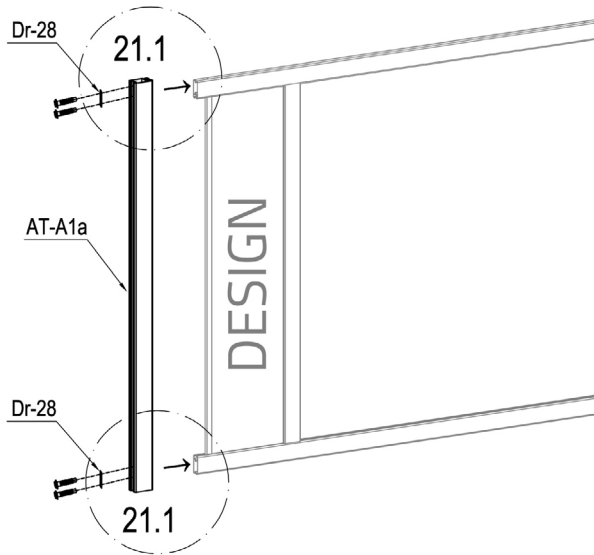

Part C.

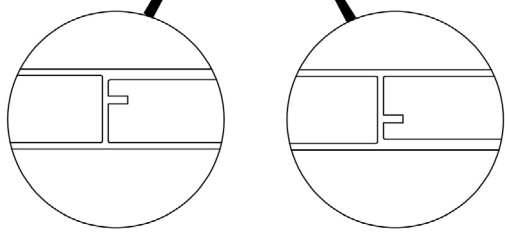
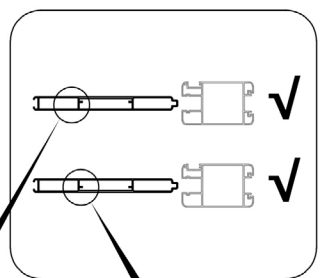
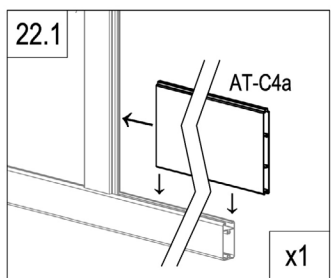
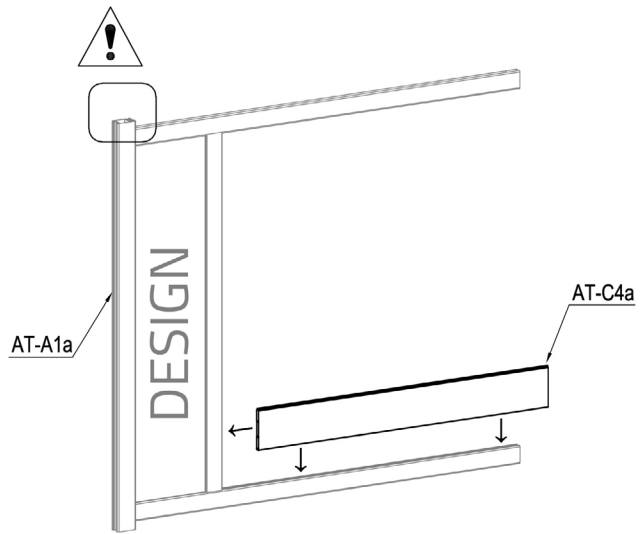

	AT-A1a	1
	Dr-28	2
	AT-CP32	4

Part C.



	AT-C4a	1
---	--------	---

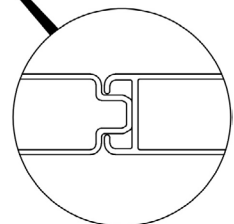
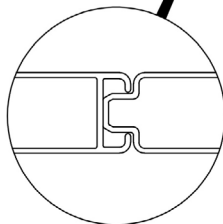
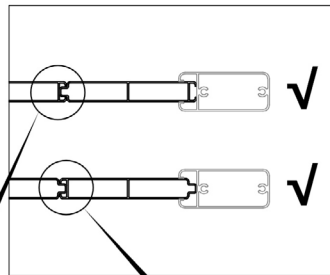
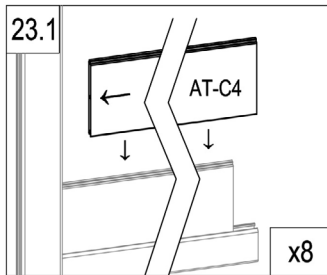
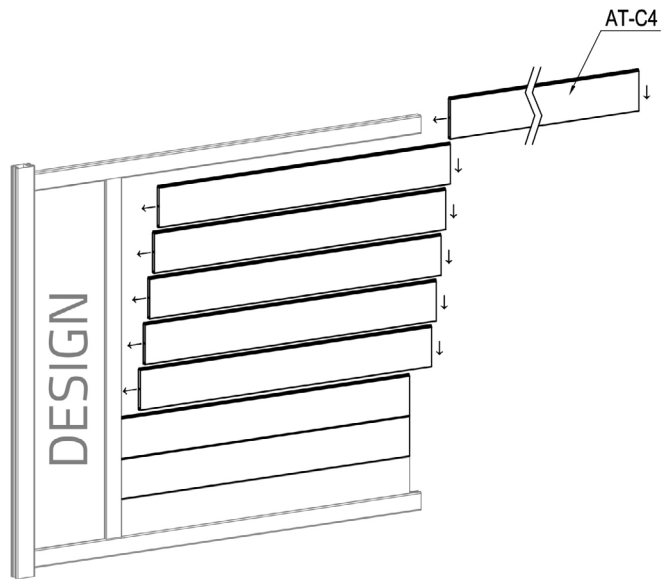

Part C.

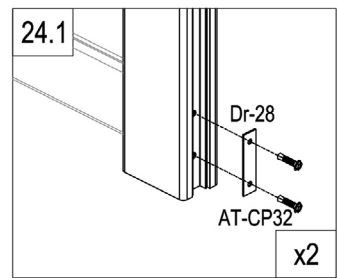
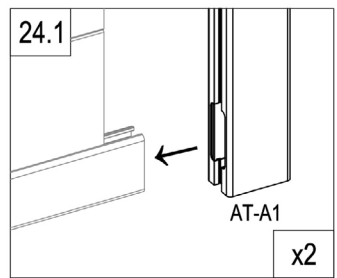
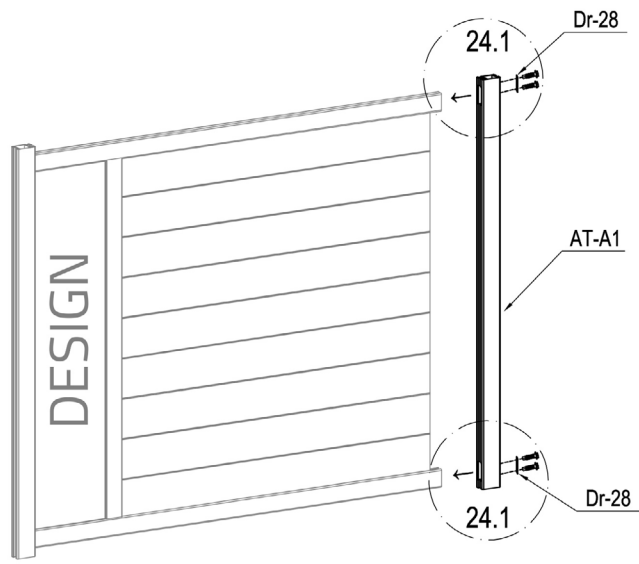

	AT-C4	8
---	-------	---

Part C.



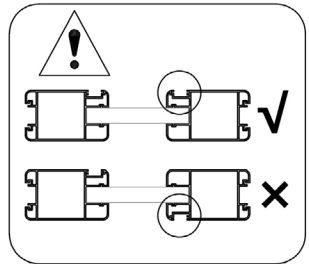

	AT-A1	1
	Dr-28	2
	AT-CP32	4

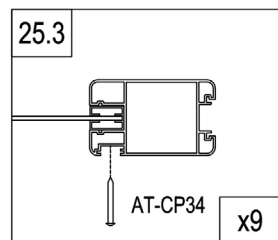
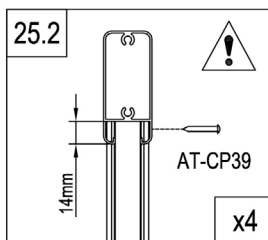
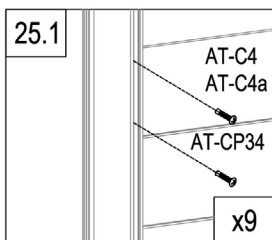
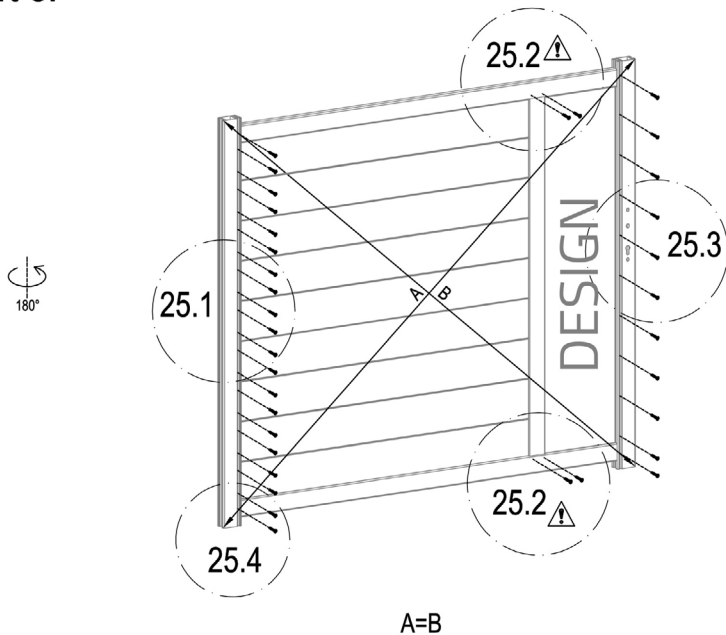

Part C.



	AT-CP34	4
	AT-CP35	27
	AT-CP39	4

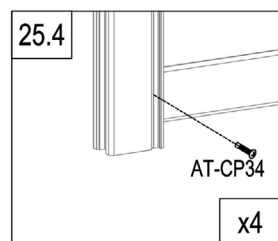

Part C.

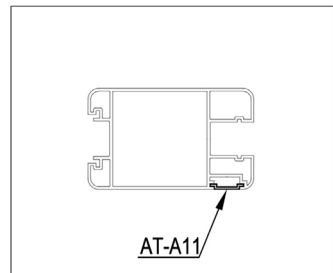
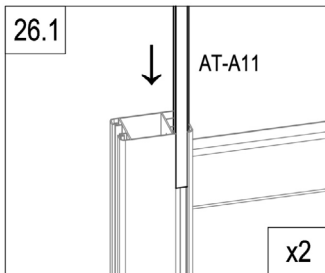
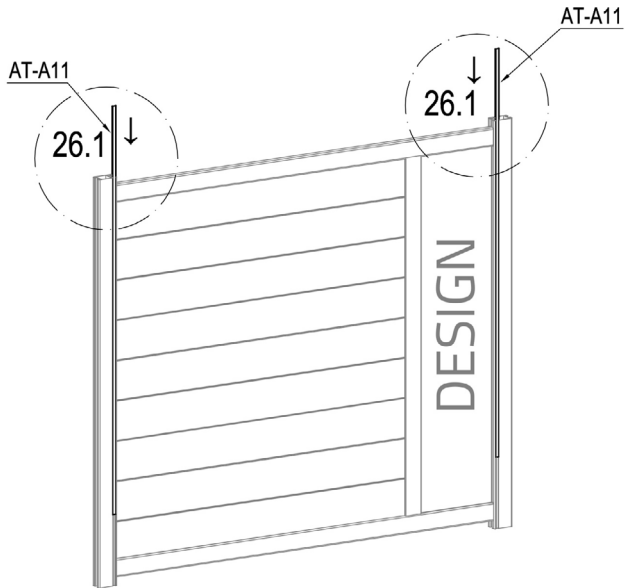

	AT-A11	2
---	--------	---

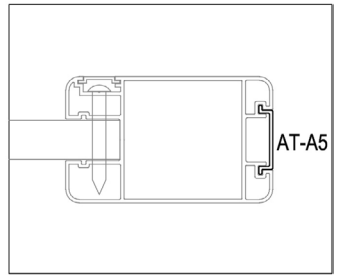
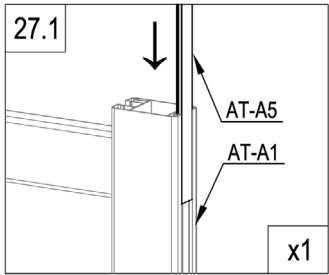
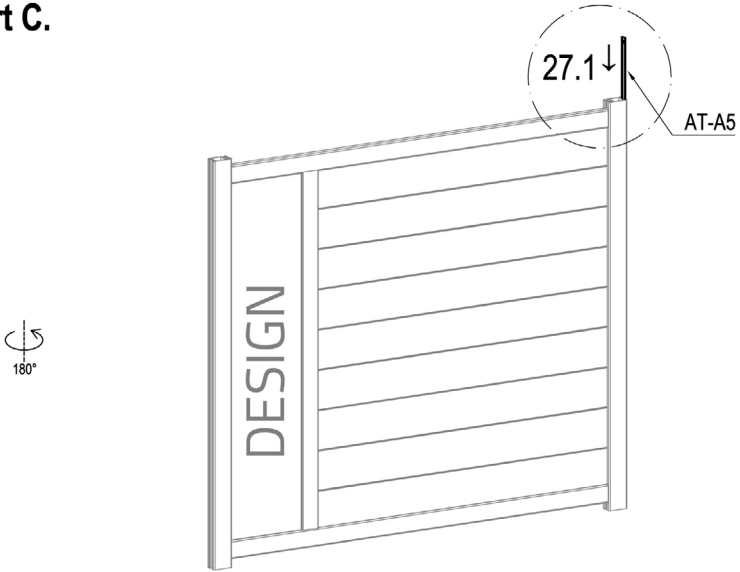

Part C.





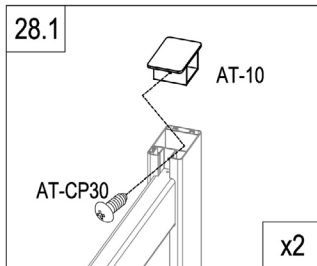
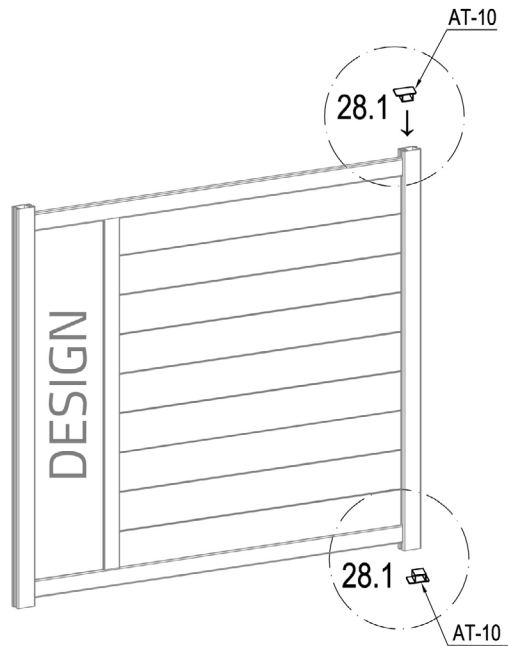

]	AT-A5	1
---	-------	---

Part C.

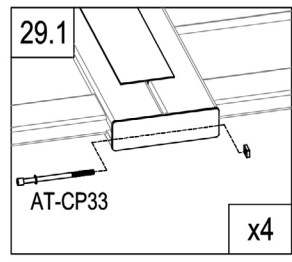
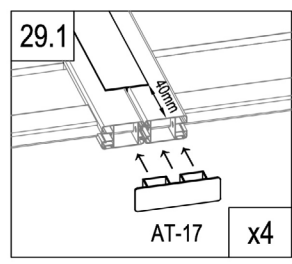
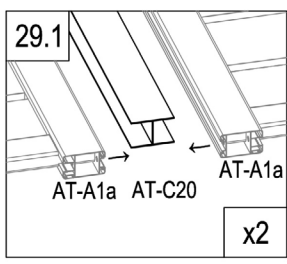
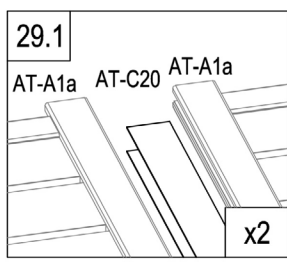
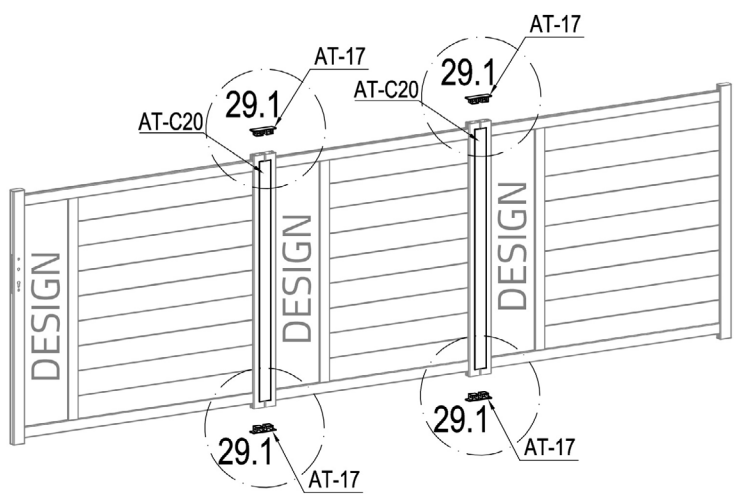



	AT-10	2
	AT-CP30	2

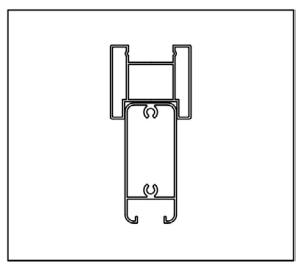
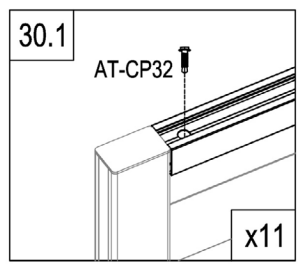
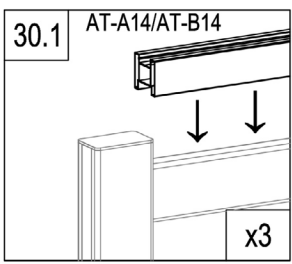
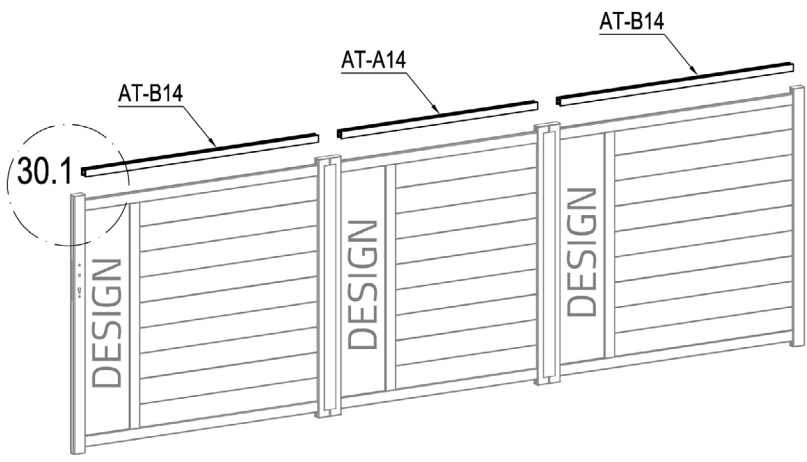

	AT-C20	2
	AT-17	4
	AT-CP33	4



	AT-A14	1
	AT-B14	2
	AT-CP32	11

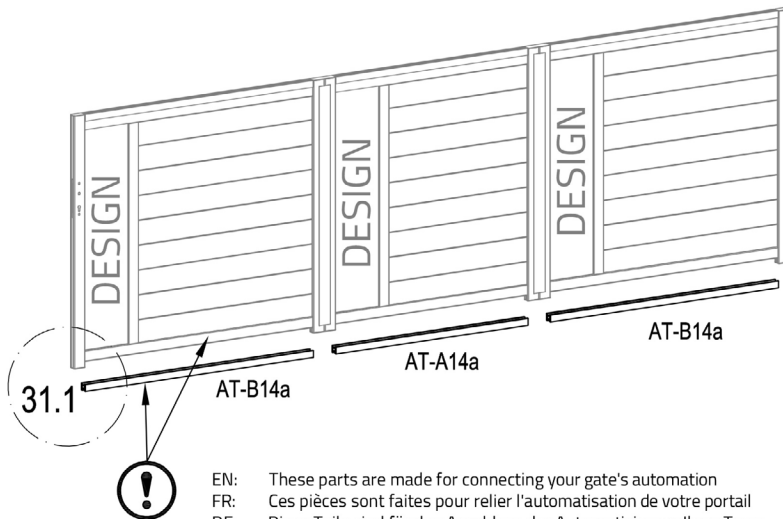

EN: These parts are made for connecting your gate's automation
 FR: Ces pièces sont faites pour relier l'automatisation de votre portail
 DE: Diese Teile sind für den Anschluss der Automatisierung Ihres Tores vorgesehen
 ES: Estas piezas están hechas para conectar la automatización de su puerta
 PT: Estas peças são feitas para ligar a automatização do seu portão
 IT: Queste parti sono realizzate per collegare l'automazione del vostro cancello
 NL: Deze onderdelen zijn gemaakt voor het aansluiten van de automatisering van uw poort.
 PL: Te części są wykonane do podłączenia automatyki bramy.

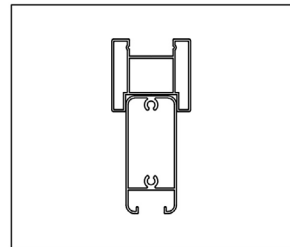
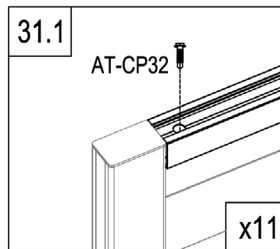
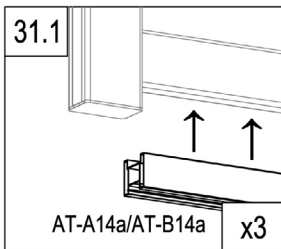

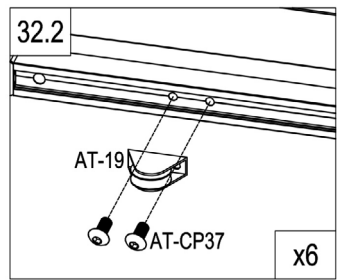
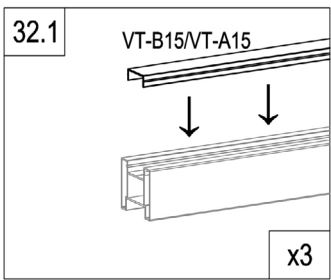
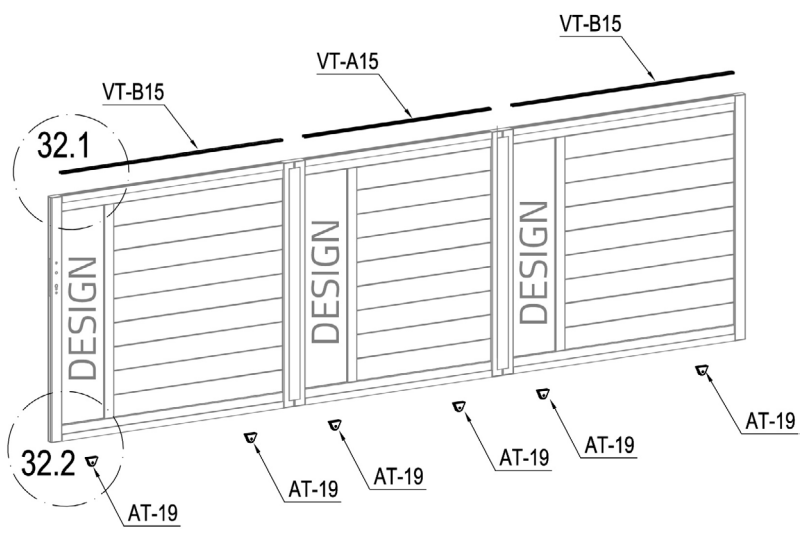

	AT-A14a	1
	AT-B14a	2
	AT-CP32	11

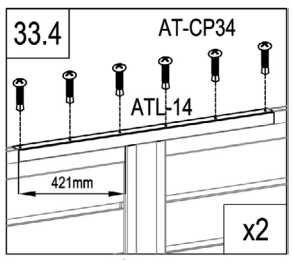
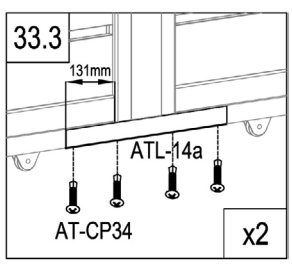
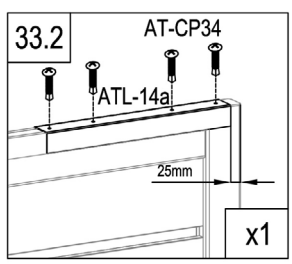
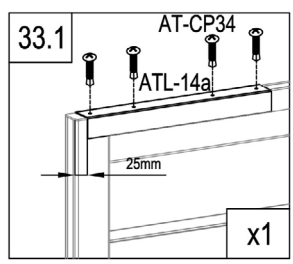
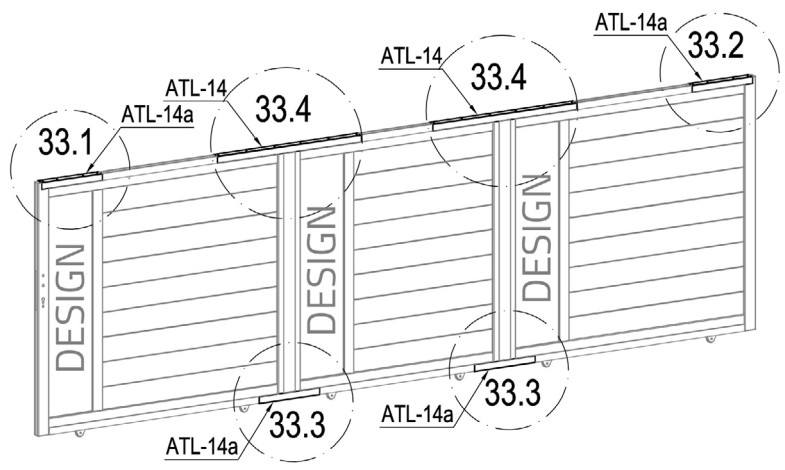

┌	VT-A15	1
	VT-B15	2
⌋	AT-19	6
⌋	AT-CP37	12



	ATL-14	2
	ATL-14a	4
	AT-CP34	28

Ext.

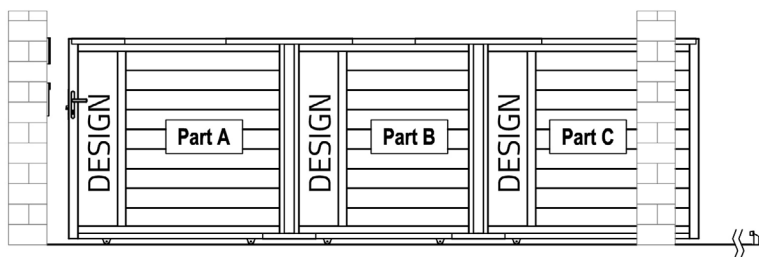

Int.

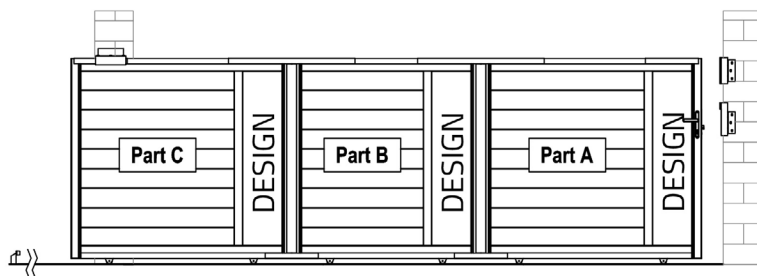

Ext.

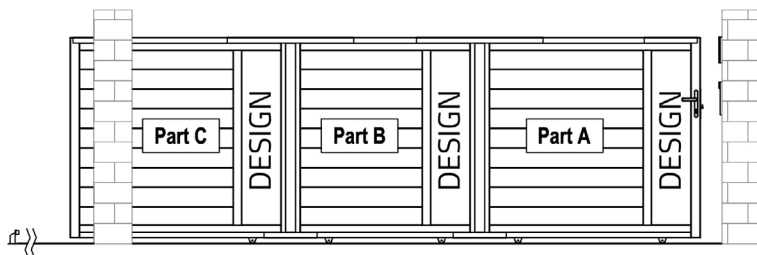

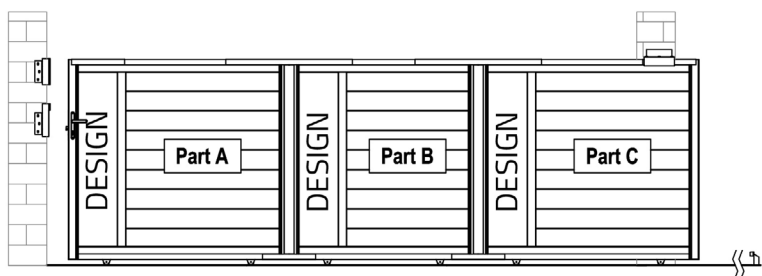

Int.

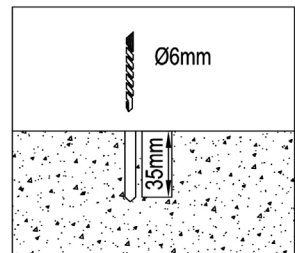
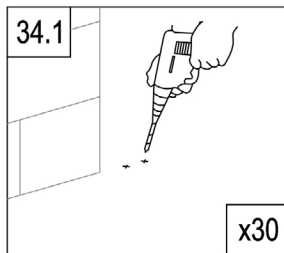
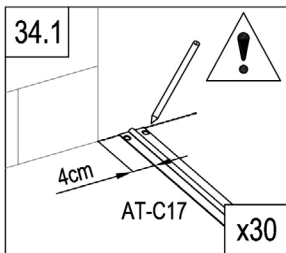
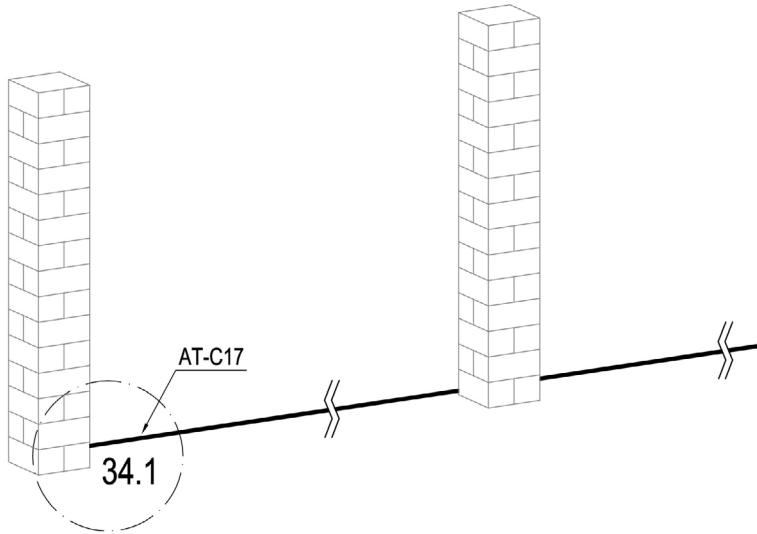

R

L



	AT-C17	6
	AT-CP38	60

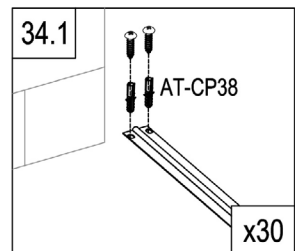

L

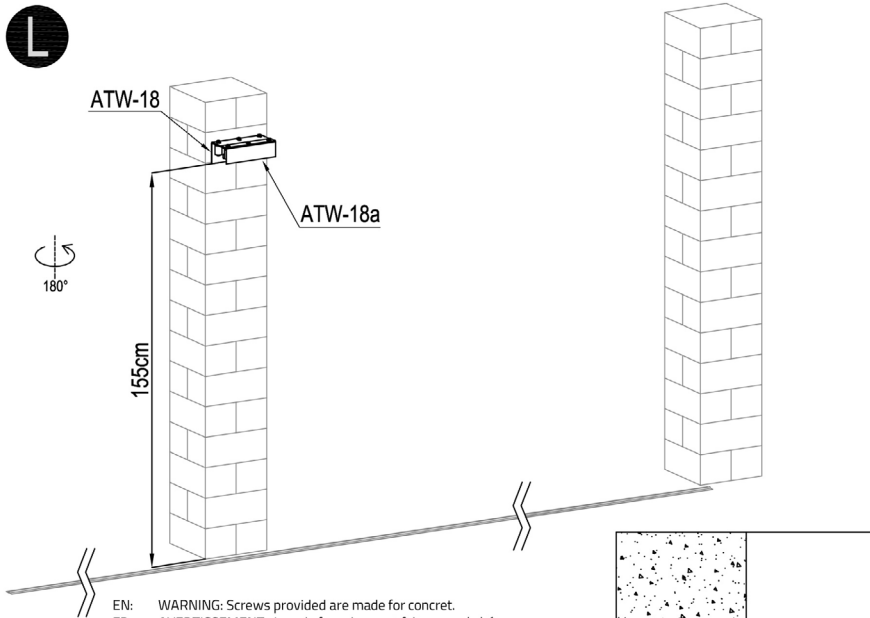

EN: WARNING: Screws provided are made for concret.
 FR: AVERTISSEMENT : Les vis fournies sont faites pour le béton.
 DE: WARNUNG: Die mitgelieferten Schrauben sind für Beton ausgelegt.
 ES: ADVERTENCIA: Los tornillos suministrados están hechos para el hormigón.
 IT: ATTENZIONE: Le viti fornite sono fatte per il calcestruzzo.
 NL: WAARSCHUWING: De bijgeleverde schroeven zijn gemaakt voor beton.
 PL: OSTRZEŻENIE: Dostarczone śruby są przeznaczone do betonu.
 PT: AVISO: Os parafusos fornecidos são feitos para betão.

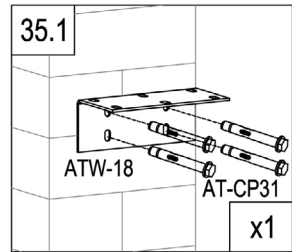
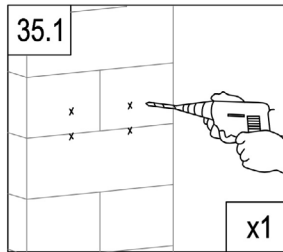
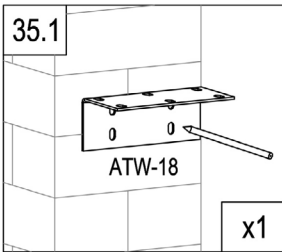
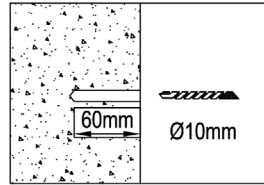

	ATW-18	1
	ATW-18a	1
	AT-20	6
	AT-CP31	4

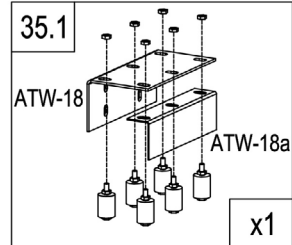
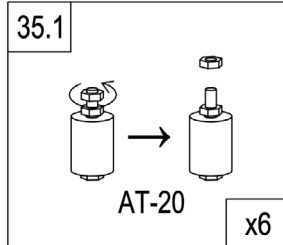

L

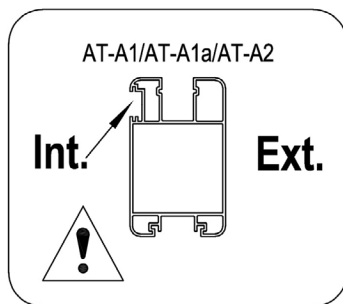
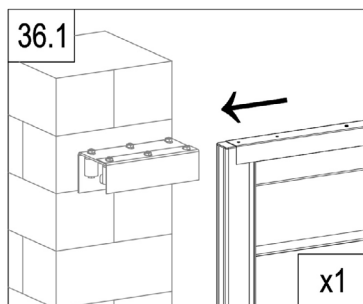
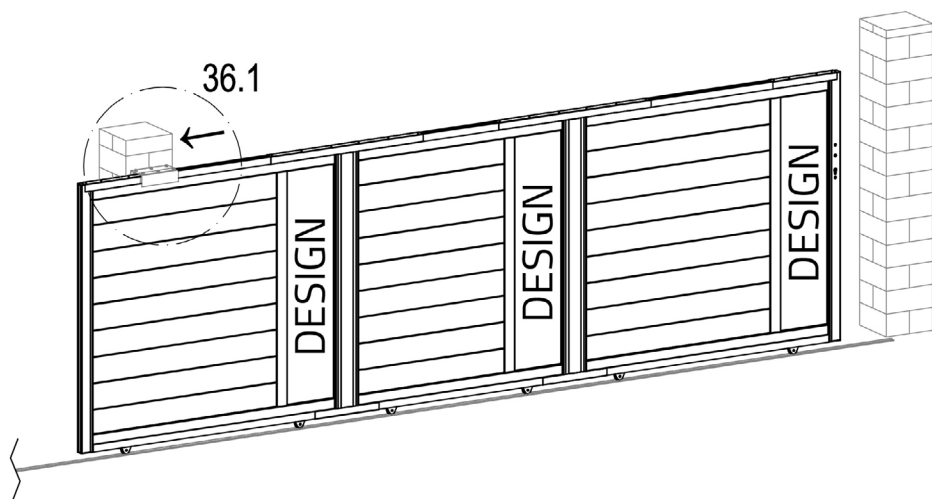

L

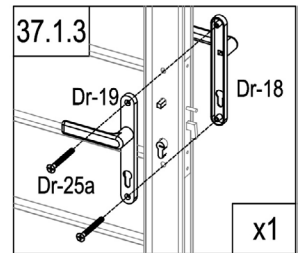
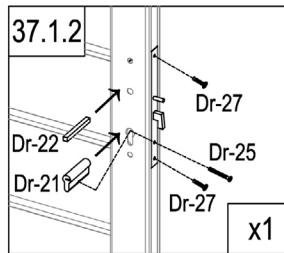
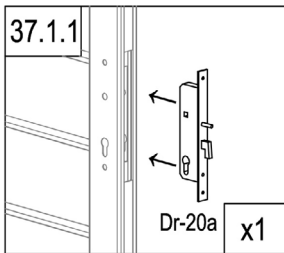
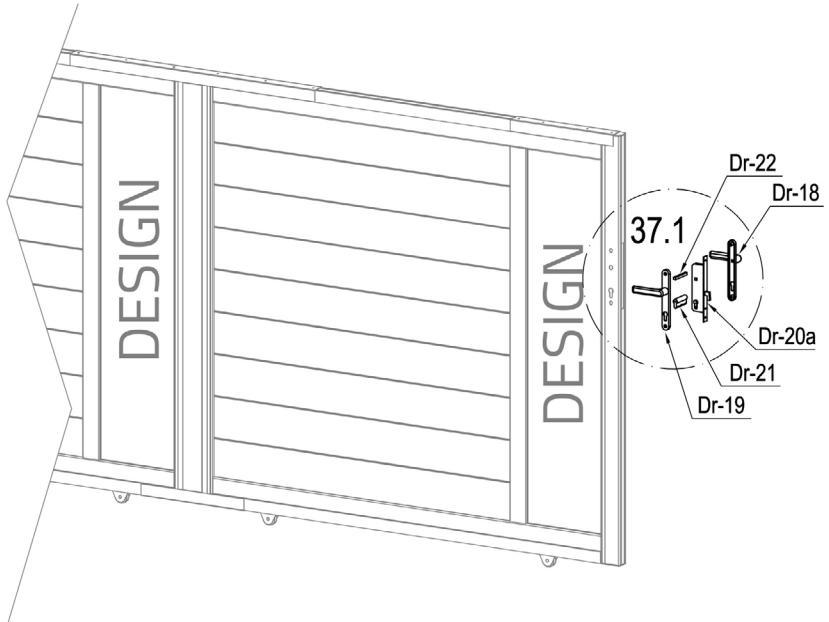

	Dr-20a	1
	Dr-21	1
	Dr-22	1
	Dr-25	1

	Dr-18	1
	Dr-19	1
	Dr-25a	2
	Dr-27	2



EN: WARNING: Screws provided are made for concret.
 FR: AVERTISSEMENT : Les vis fournies sont faites pour le béton.
 DE: WARNUNG: Die mitgelieferten Schrauben sind für Beton ausgelegt.
 ES: ADVERTENCIA: Los tornillos suministrados están hechos para el hormigón.
 IT: ATTENZIONE: Le viti fornite sono fatte per il calcestruzzo.
 NL: WAARSCHUWING: De bijgeleverde schroeven zijn gemaakt voor beton.
 PL: OSTRZEŻENIE: Dostarczone śruby są przeznaczone do betonu.
 PT: AVISO: Os parafusos fornecidos são feitos para betão.

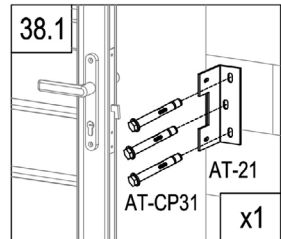
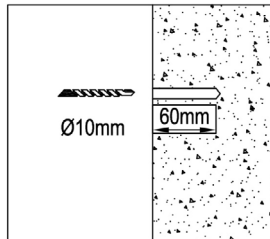
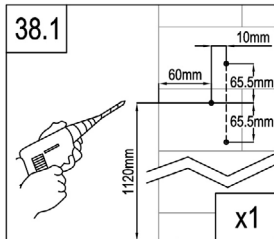
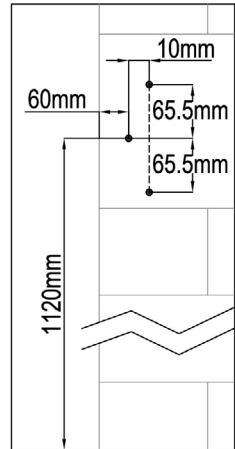
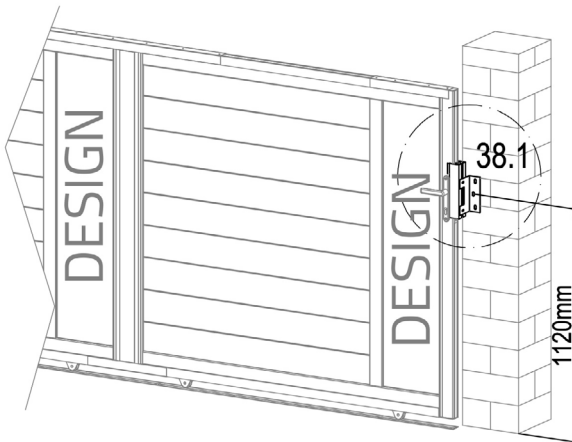

	AT-16	1
	AT-21	1
	AT-CP36	2
	AT-CP31	3
	AT-22J	3

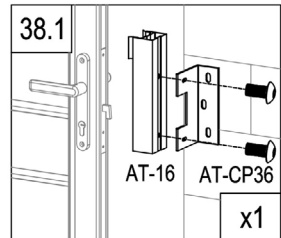
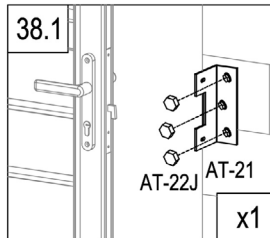

L

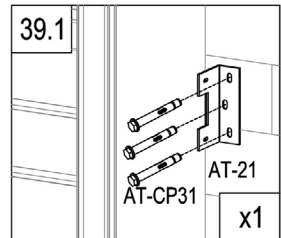
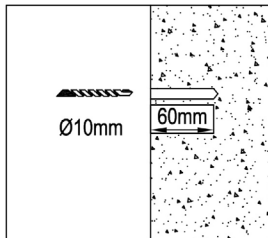
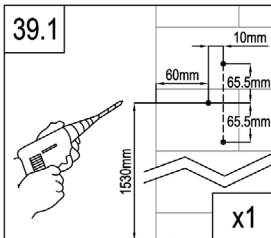
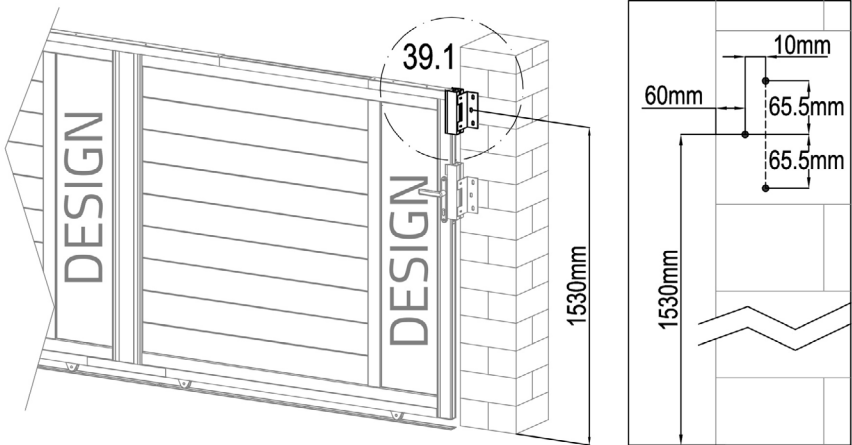

	AT-16a	1
	AT-21	1
	AT-CP36	2
	AT-CP31	3
	AT-22J	3

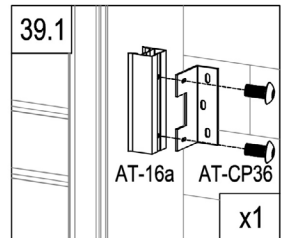
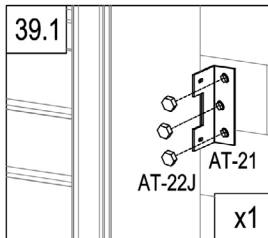

L

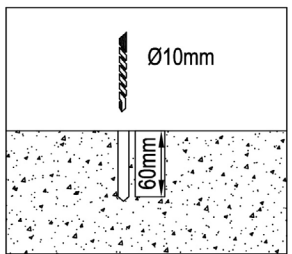
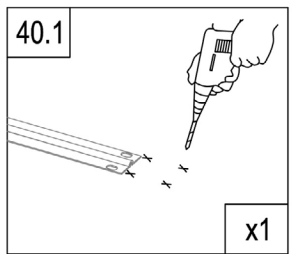
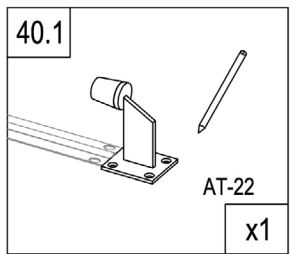
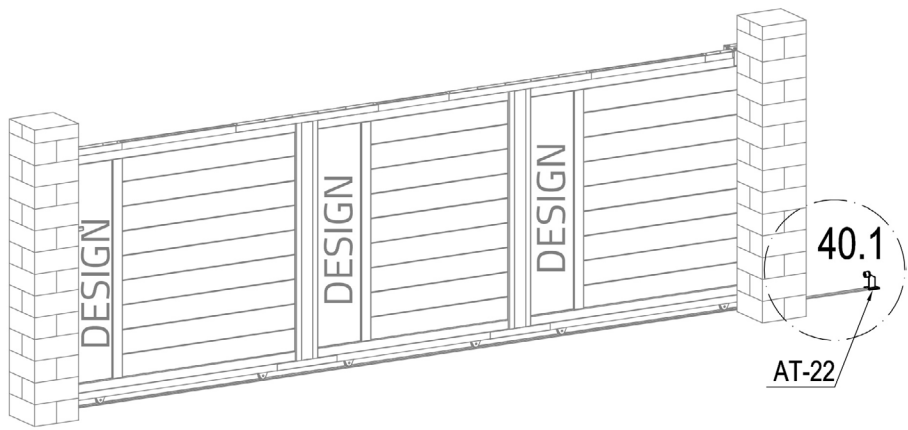

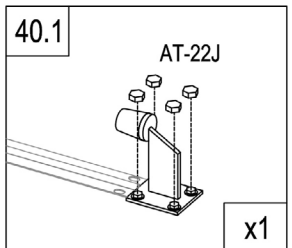
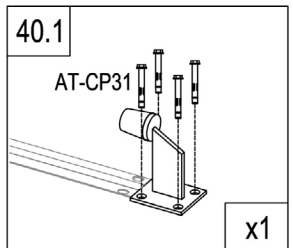

	AT-22	1
	AT-CP31	4
	AT-22J	4

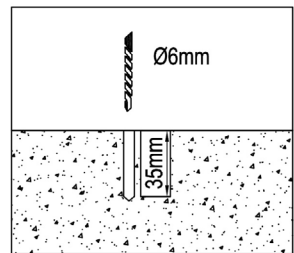
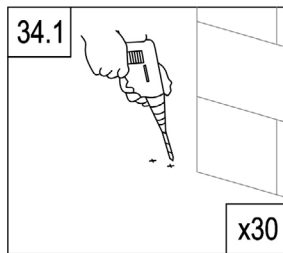
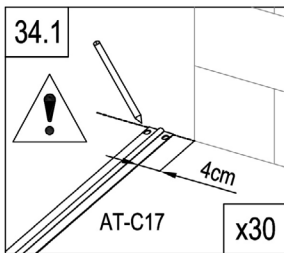
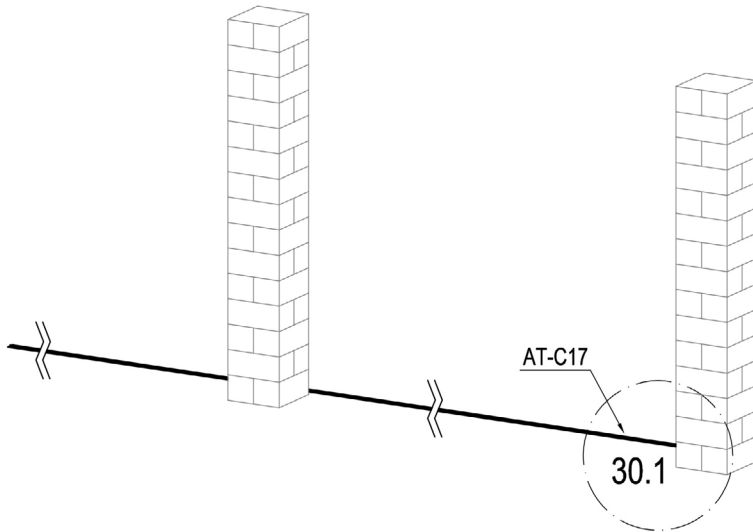

R



	AT-C17	6
	AT-CP38	60

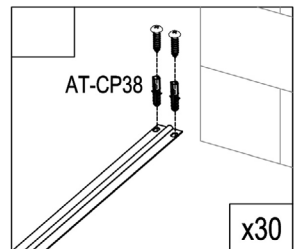

R

180°

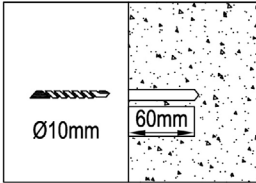
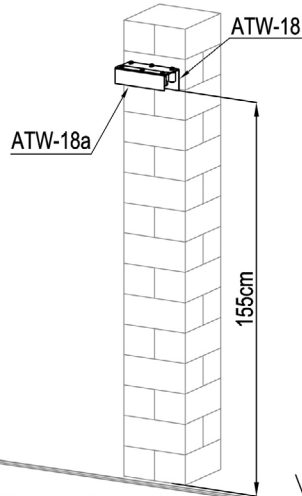

EN: WARNING: Screws provided are made for concret.
 FR: AVERTISSEMENT : Les vis fournies sont faites pour le béton.
 DE: WARNUNG: Die mitgelieferten Schrauben sind für Beton ausgelegt.
 ES: ADVERTENCIA: Los tornillos suministrados están hechos para el hormigón.
 IT: ATTENZIONE: Le viti fornite sono fatte per il calcestruzzo.
 NL: WAARSCHUWING: De bijgeleverde schroeven zijn gemaakt voor beton.
 PL: OSTRZEŻENIE: Dostarczone śruby są przeznaczone do betonu.
 PT: AVISO: Os parafusos fornecidos são feitos para betão.

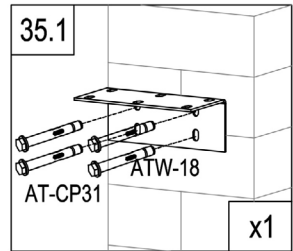
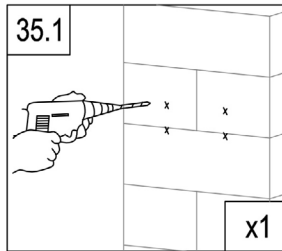
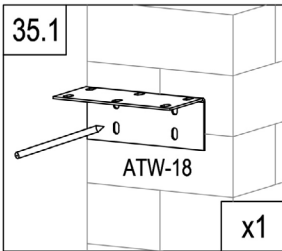

	ATW-18	1
	ATW-18a	1
	AT-20	6
	AT-CP31	4

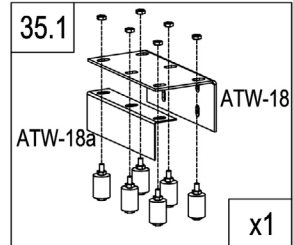
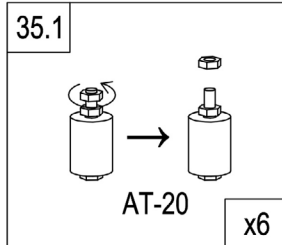

R

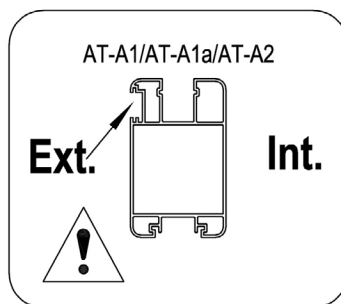
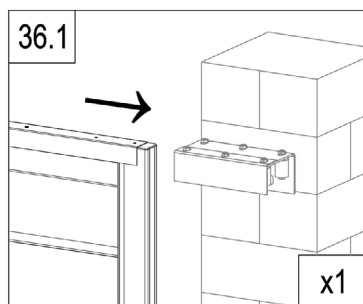
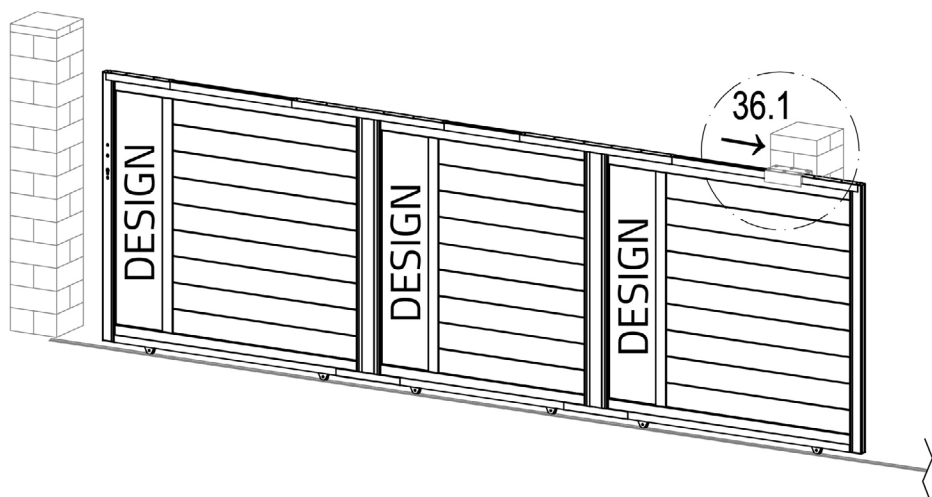

R

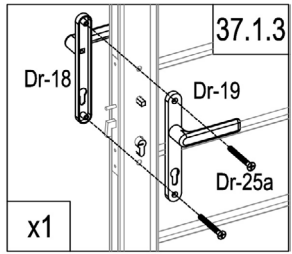
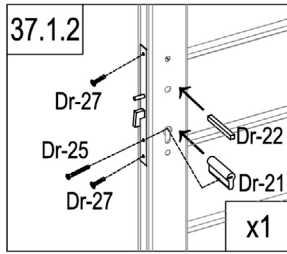
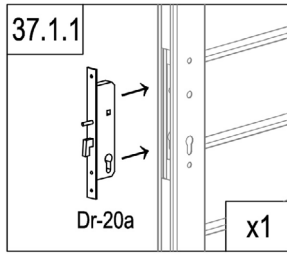
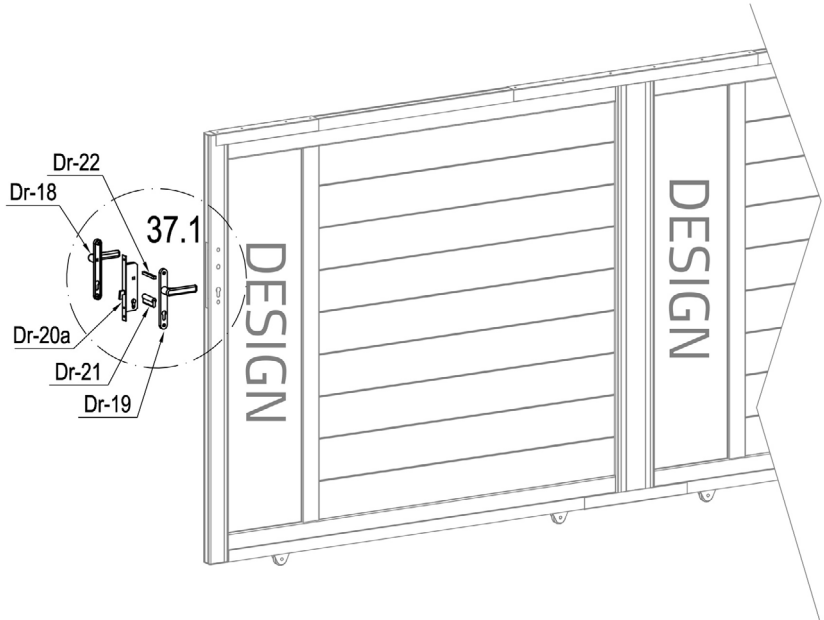

	Dr-20a	1
	Dr-21	1
	Dr-22	1
	Dr-25	1

	Dr-18	1
	Dr-19	1
	Dr-25a	2
	Dr-27	2

R

EN: WARNING: Screws provided are made for concret.
 FR: AVERTISSEMENT : Les vis fournies sont faites pour le béton.
 DE: WARNUNG: Die mitgelieferten Schrauben sind für Beton ausgelegt.
 ES: ADVERTENCIA: Los tornillos suministrados están hechos para el hormigón.
 IT: ATTENZIONE: Le viti fornite sono fatte per il calcestruzzo.
 NL: WAARSCHUWING: De bijgeleverde schroeven zijn gemaakt voor beton.
 PL: OSTRZEŻENIE: Dostarczone śruby są przeznaczone do betonu.
 PT: AVISO: Os parafusos fornecidos são feitos para betão.

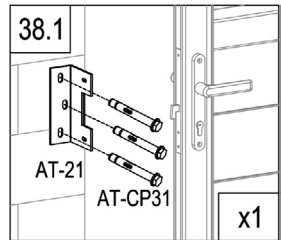
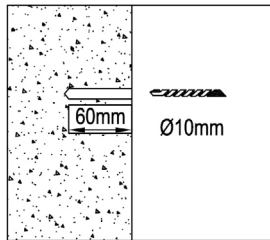
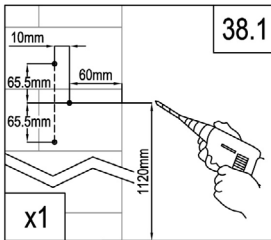
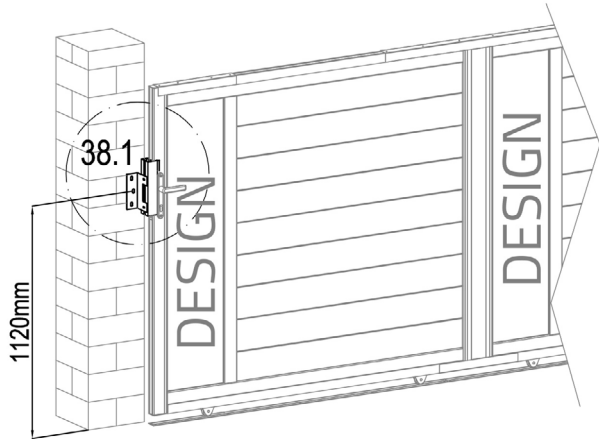
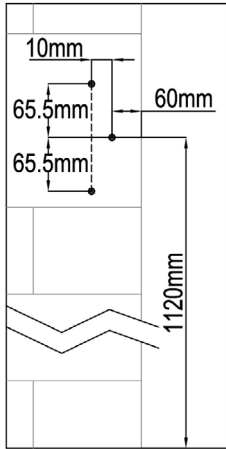

	AT-16	1
	AT-21	1
	AT-CP36	2
	AT-CP31	3
	AT-22J	3

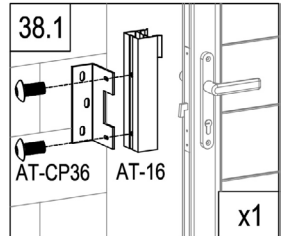
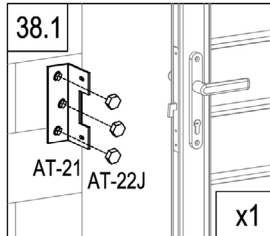

R

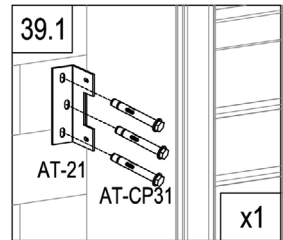
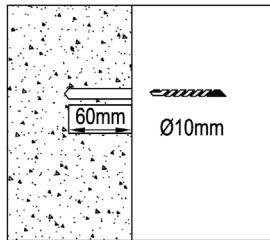
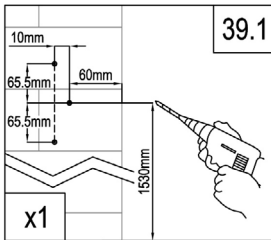
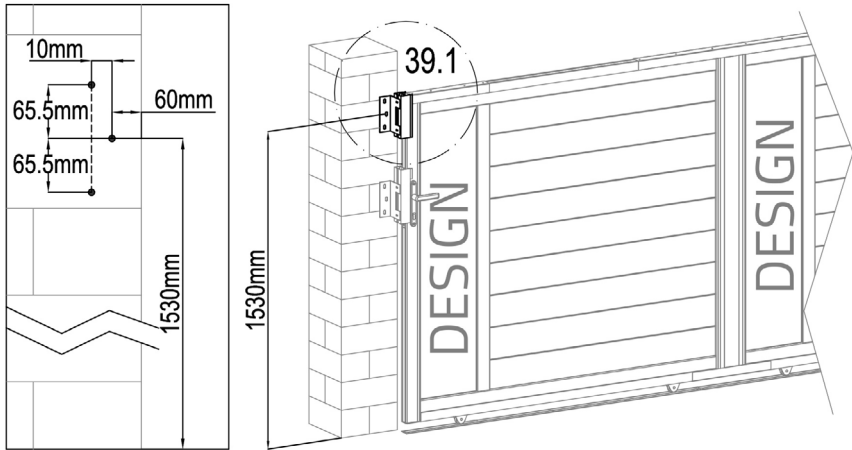

	AT-16a	1
	AT-21	1
	AT-CP36	2
	AT-CP31	3
	AT-22J	3

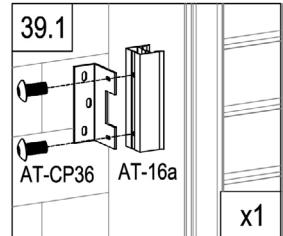
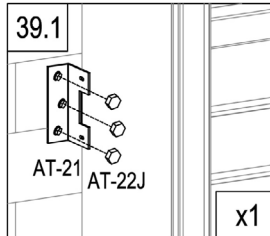

R

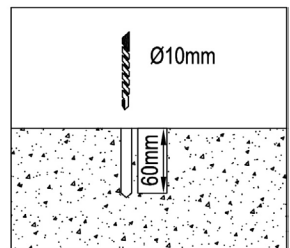
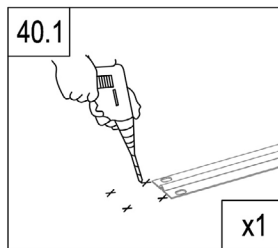
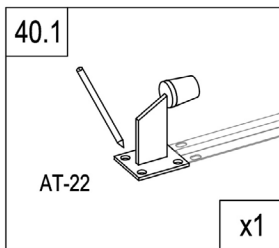
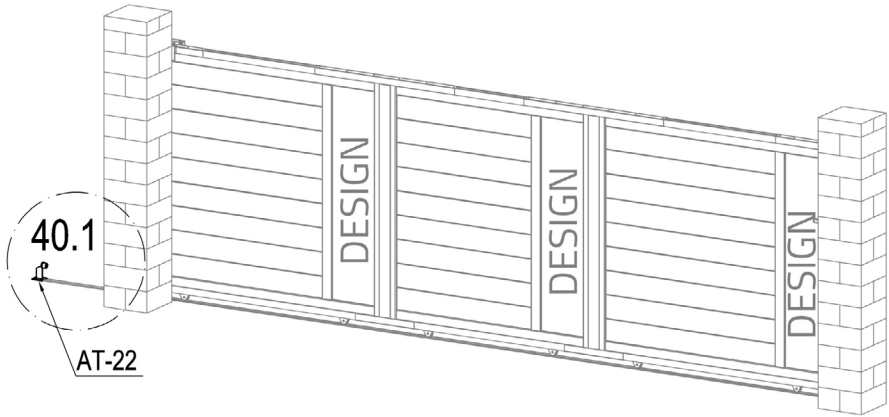

	AT-22	1
	AT-CP31	4
	AT-22J	4

