

CASANOVO

ARLBERG 600C160

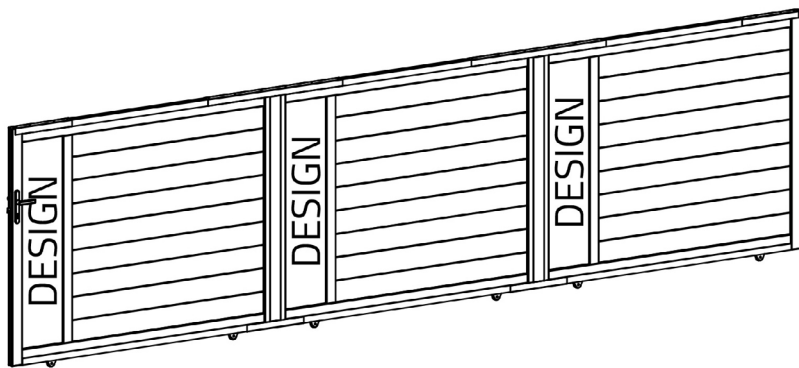

COM-001092 [x1]

COM-001094 [x1]

COM-001096 [x1]

COM-000198 [x1]

COM-001093 [x1]

COM-001095 [x1]

COM-000196 [x1]



INSTRUCTION MANUAL / NOTICE DE MONTAGE / MONTAGEANLEITUNG / MANUAL DE MONTAJE / MANUAL DE MONTAGEM / MANUALE DI MONTAGGIO /
MONTAGEHANDLEIDING / INSTRUKCJA MONTAŻU / KÄYTTÖOHJEET / BRUKSANVISNING / BRUGSANVISNING / INSTRUCIUNI DE ASAMBLARE /
NAVODILA ZA SESTAVLJANJE / NÁVOD NA MONTÁŽ / ÖSSZESZERELÉSI ÚTMUTATÓ / NÁVOD K MONTÁŽI / UPUTE ZA INSTALACIJU /
ΟΔΗΓΙΕΣ ΣΥΝΑΡΜΟΛΟΓΗΣΗΣ / SURINKIMO INSTRUKCIJOS / MONTŽAS INSTRUKCIJAS

Ext.

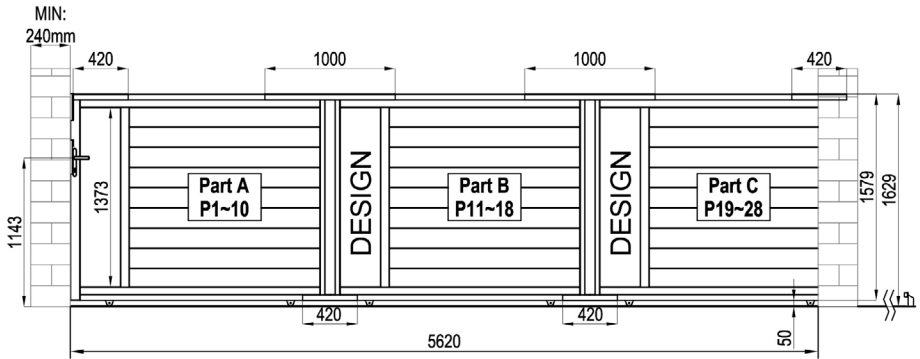

Int.

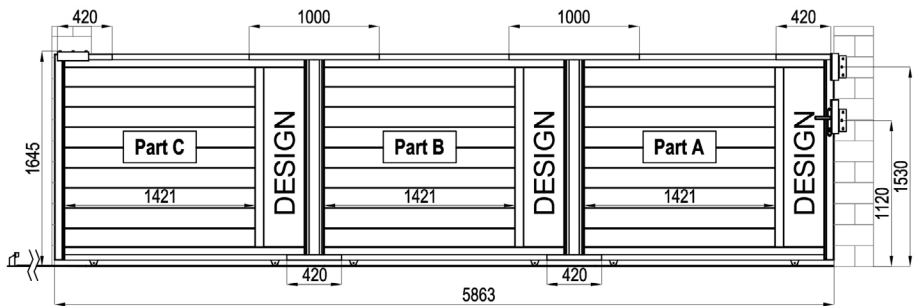

Part A.

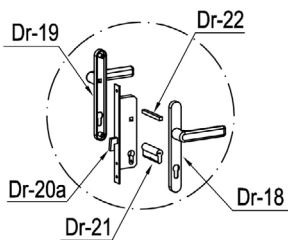
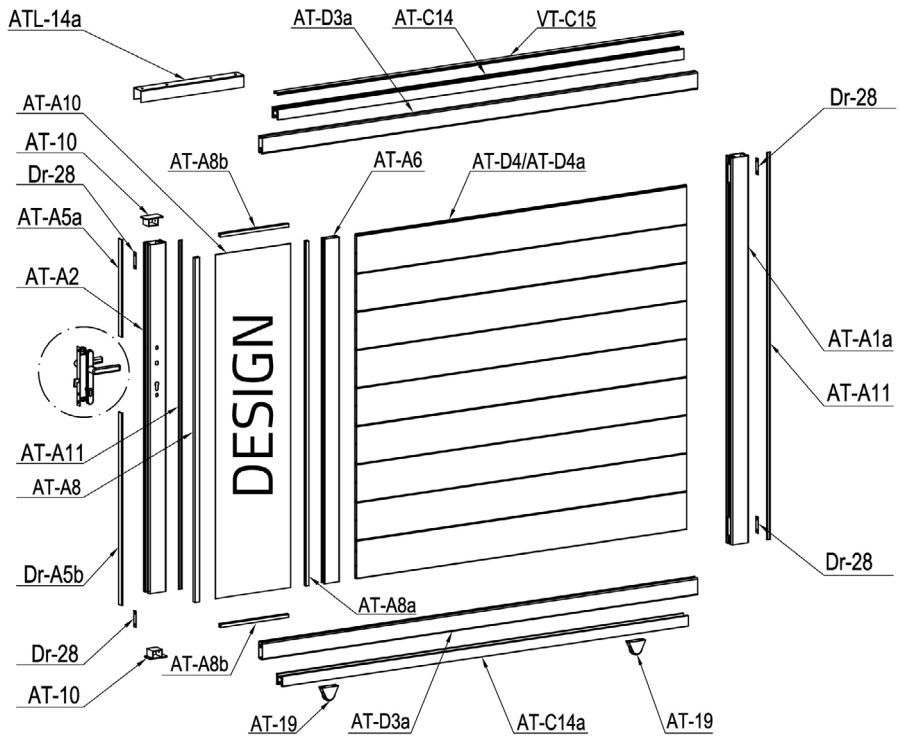

Part B.

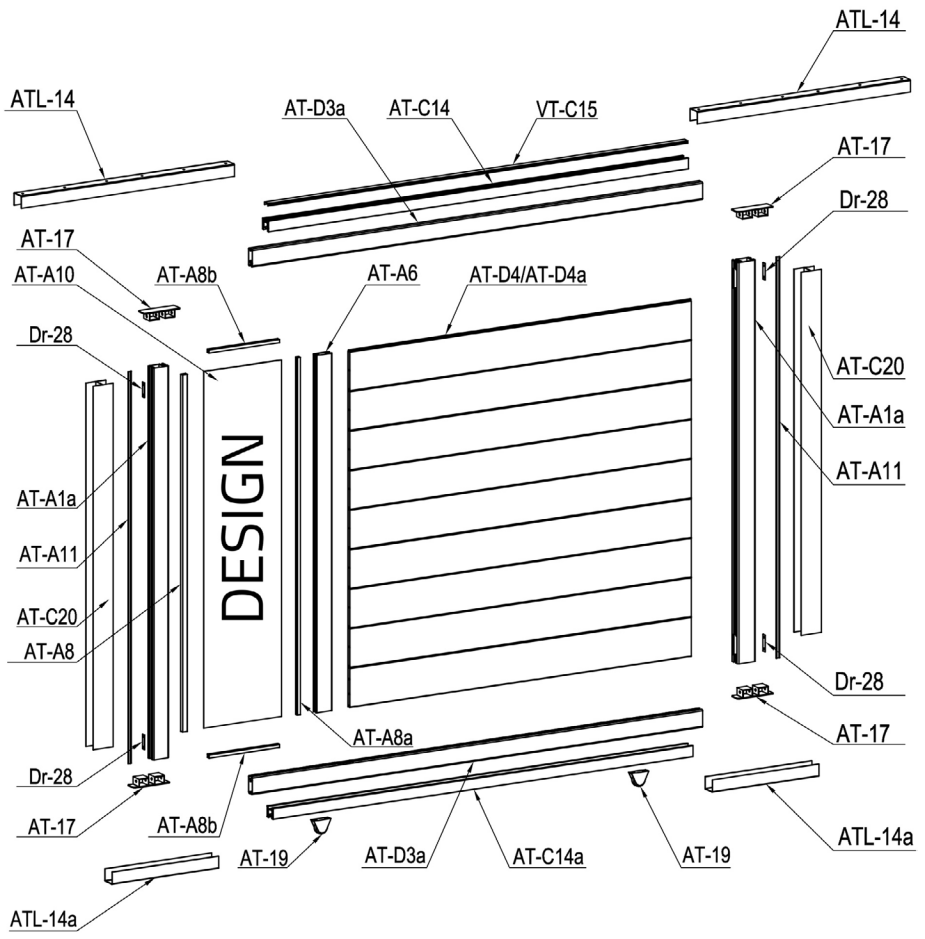

Part C.

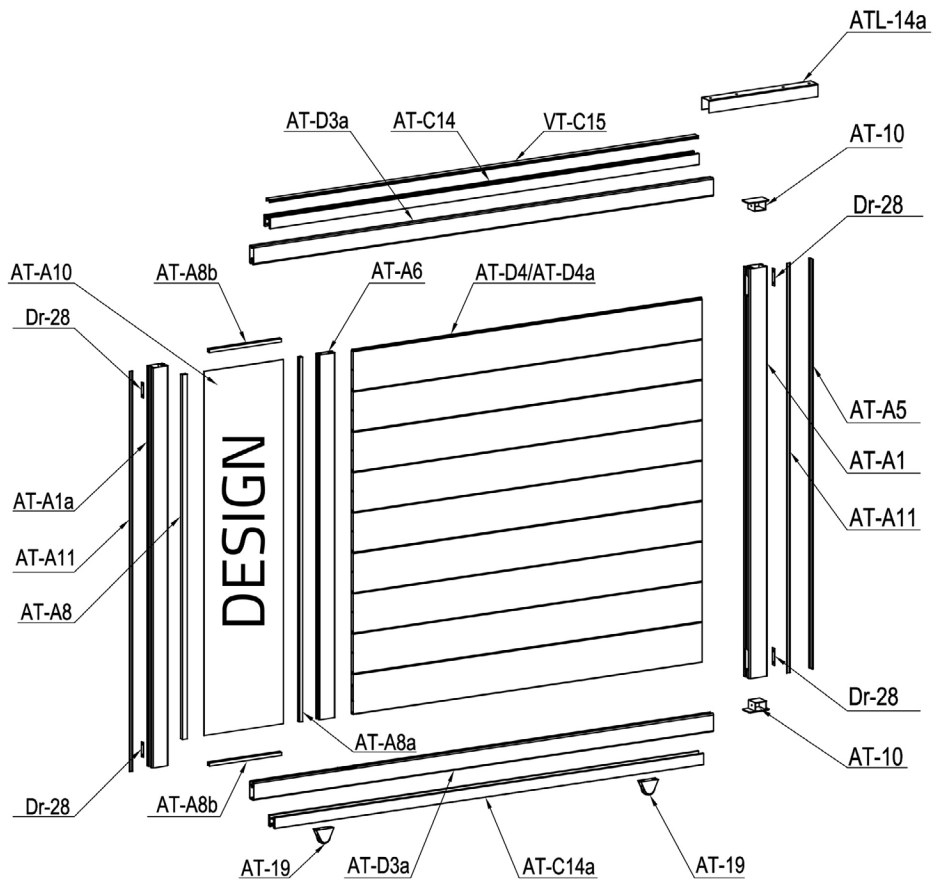

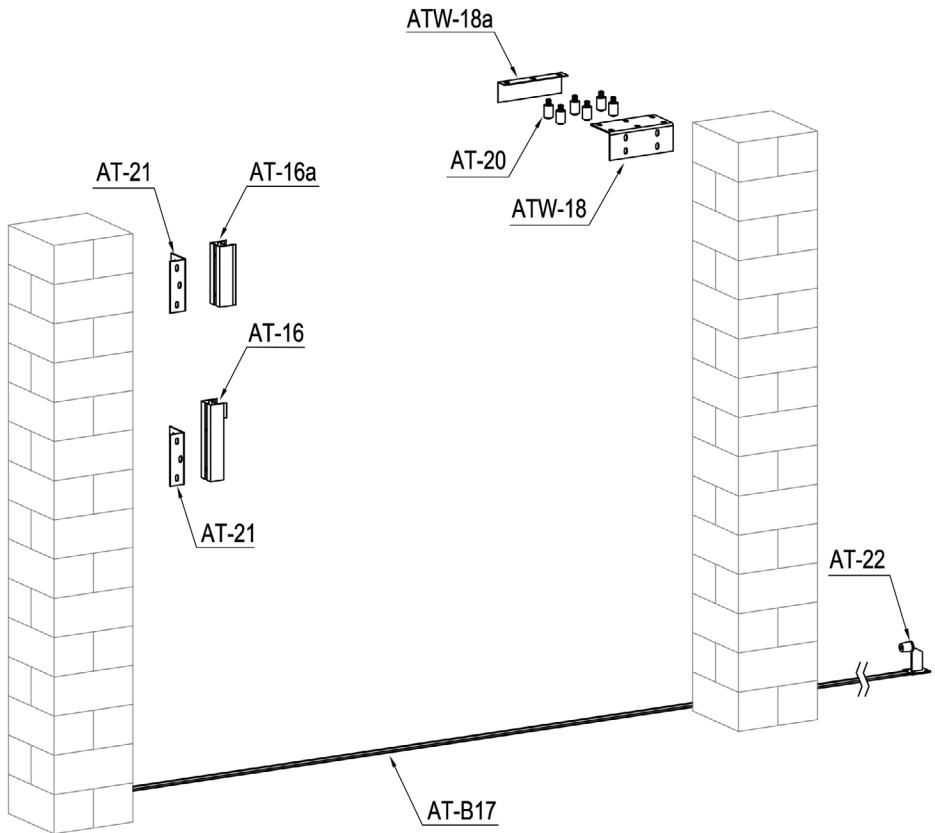

PART LIST

IMAGE	NO.	L.(mm)	QTY	IMAGE	NO.	L.(mm)	QTY
	AT-A1	1573	1		AT-19		6
	AT-A1a	1573	4		AT-20		6
	AT-A2	1573	1		AT-21		2
	AT-D3a	1931	6		AT-22		1
	AT-A6	1401	3		Dr-18		1
	AT-D4	1455	24		Dr-19		1
	AT-D4a	1455	3		Dr-20a		1
	AT-A5	1573	1		Dr-21		1
	AT-A5a	395.5	1		Dr-22		1
	Dr-A5b	937	1		Dr-25		1
	AT-A11	1573	6		Dr-25a		2
	AT-A8	1400	3		Dr-27		2
	AT-A8a	1400	3		Dr-28		12
	AT-A8b	308.5	6		AT-22J		10
	AT-A10	1398	3		AT-CS30	ST4x10	4
	AT-C20	1493	2		AT-CS31	M8x60	14
	AT-C14	1798	3		AT-CS32	ST5.5x38	48
	AT-C14a	1798	3		AT-CS33	M8x130	4
	VT-C15	1797	3		AT-CS34	ST4.8x38	40
	AT-16	260	1		AT-CS35	ST4.2x19	81
	AT-16a	205	1		AT-CS36	M6x20	4
	AT-B17	1412	8		AT-CS37	M8x20	12
	AT-17		4		AT-CS38	ST4x25	80
	AT-10		4		AT-CS39	ST4.2x13	12
	ATW-18		1				
	ATW-18a		1				
	ATL-14	1000	2				
	ATL-14a	420	4				

Part A.

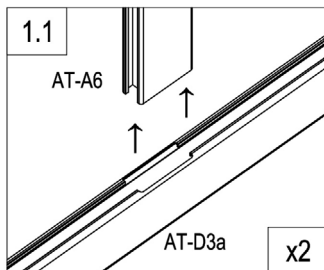
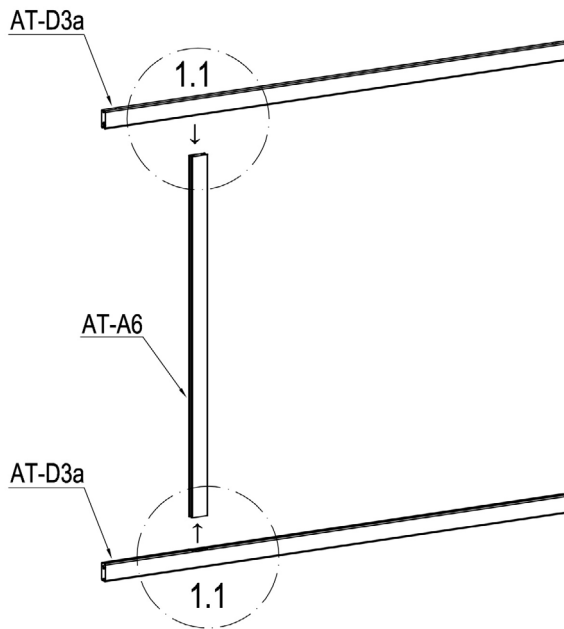

	AT-A6	1
	AT-D3a	2

Part A.

EN :you can flip and switch the direction of this plate to personalize your gate

FR: vous pouvez retourner et changer la direction de cette plaque pour personnaliser votre portail

DE: Sie können dieses Schild umdrehen und die Richtung wechseln, um Ihr Tor zu personalisieren.

ES: puedes girar y cambiar la dirección de esta placa para personalizar tu puerta





PT: pode virar e mudar a direção desta placa para personalizar o seu portão

IT: potete capovolgere e cambiare la direzione di questa piastra per personalizzare il vostro cancello

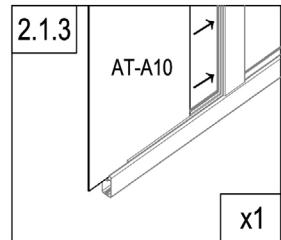
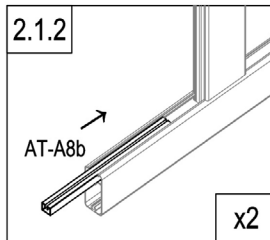
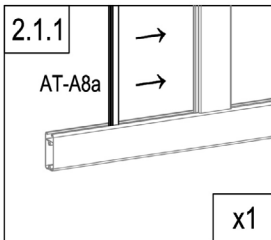
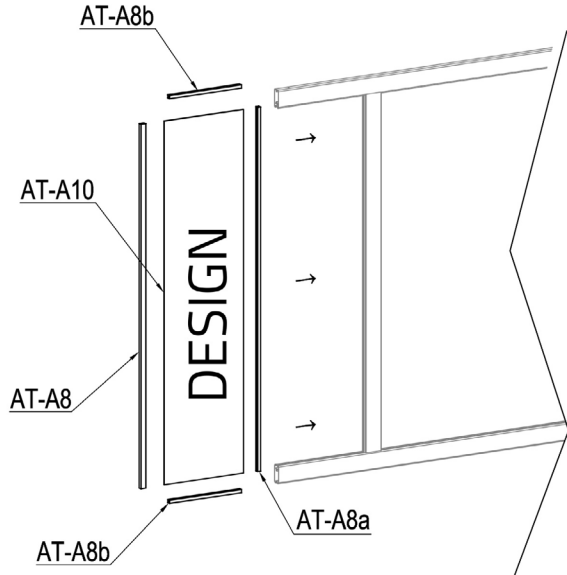
NL: u kunt de richting van deze plaat omdraaien en veranderen om uw poort te verpersoonlijken...

PL: można obrócić i przełączyć kierunek tej płyty, aby spersonalizować bramę.



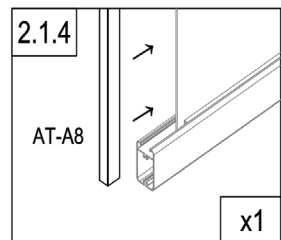

	AT-A8a	1
	AT-A8b	2
	AT-A10	1
	AT-A8	1



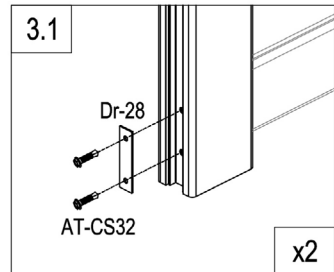
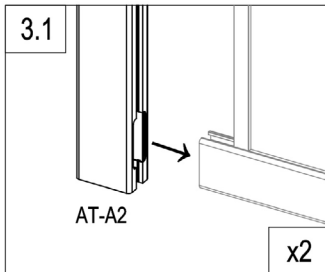
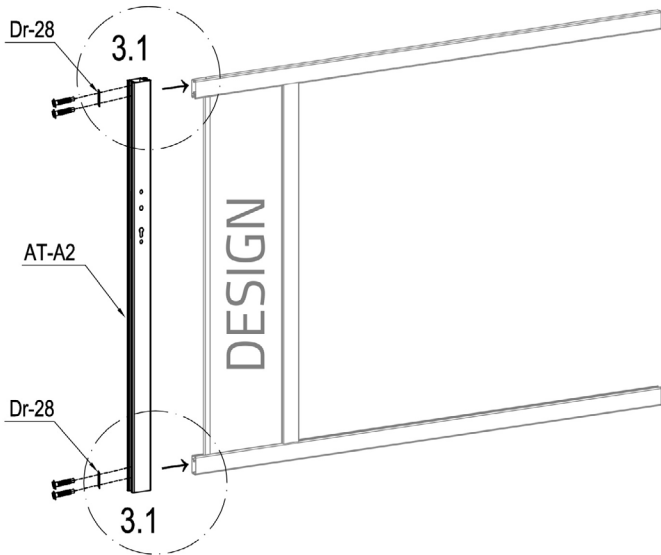

Part A.

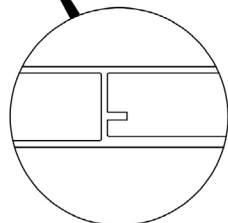
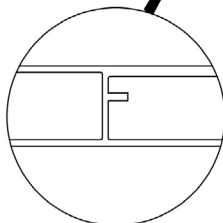
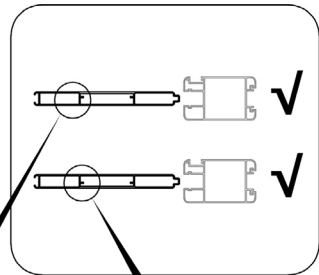
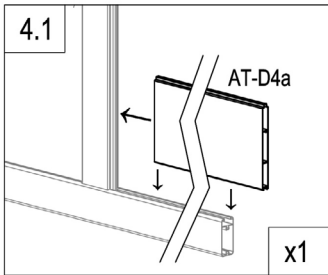
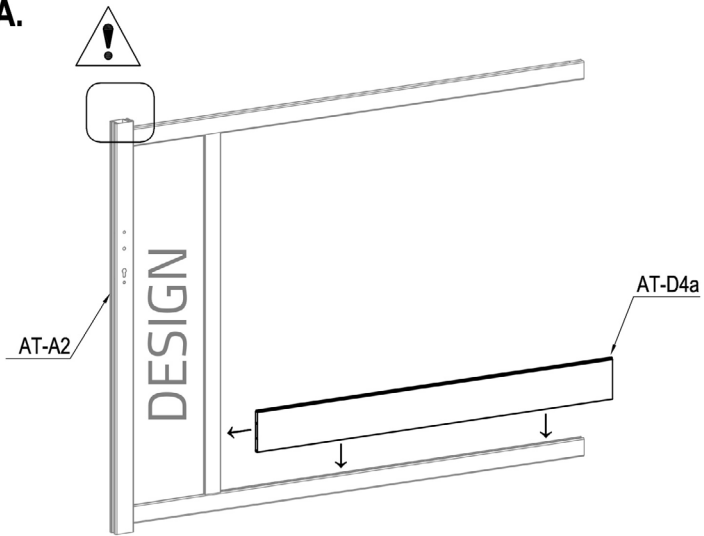

	AT-A2	1
	Dr-28	2
	AT-CS32	4

Part A.



	AT-D4a	1
---	--------	---

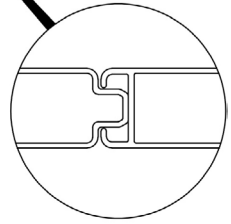
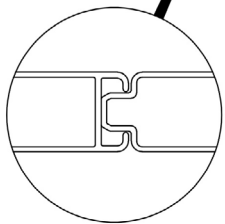
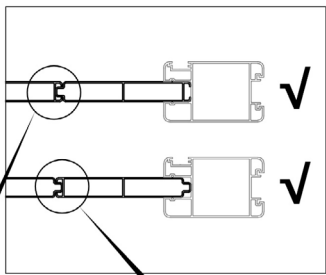
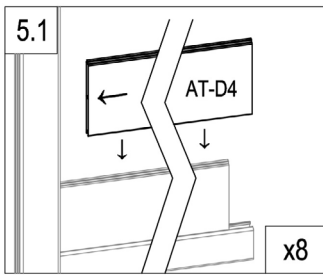
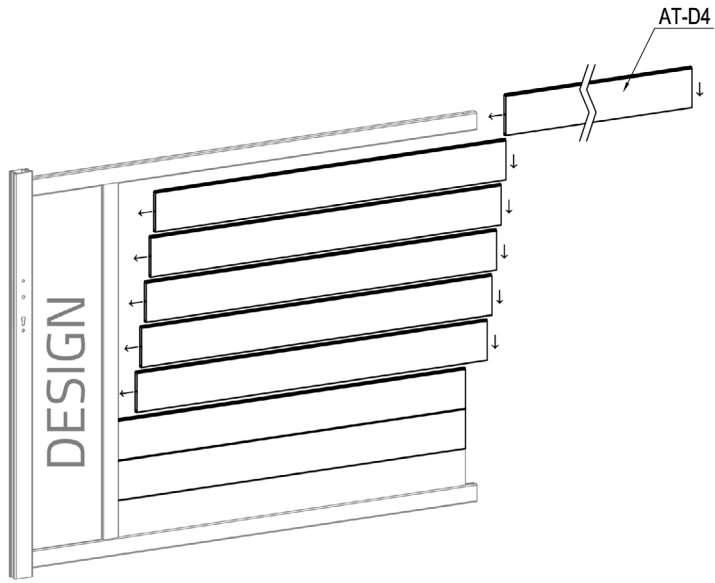

Part A.

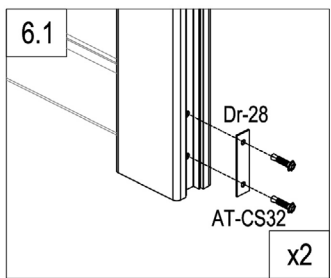
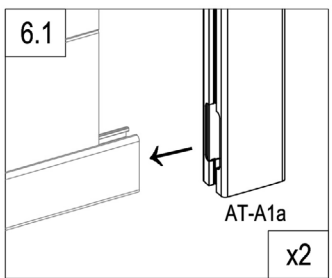
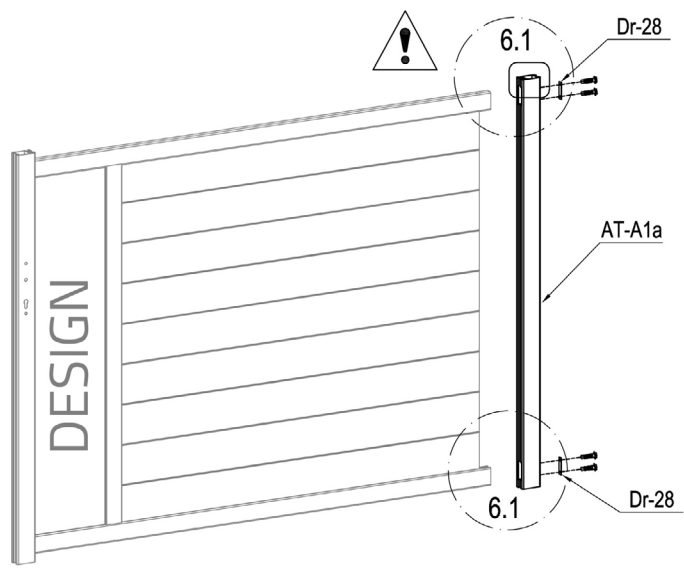

	AT-D4	8
--	-------	---

Part A.



	AT-A1a	1
	Dr-28	2
	AT-CS32	4

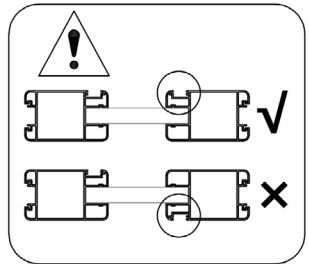

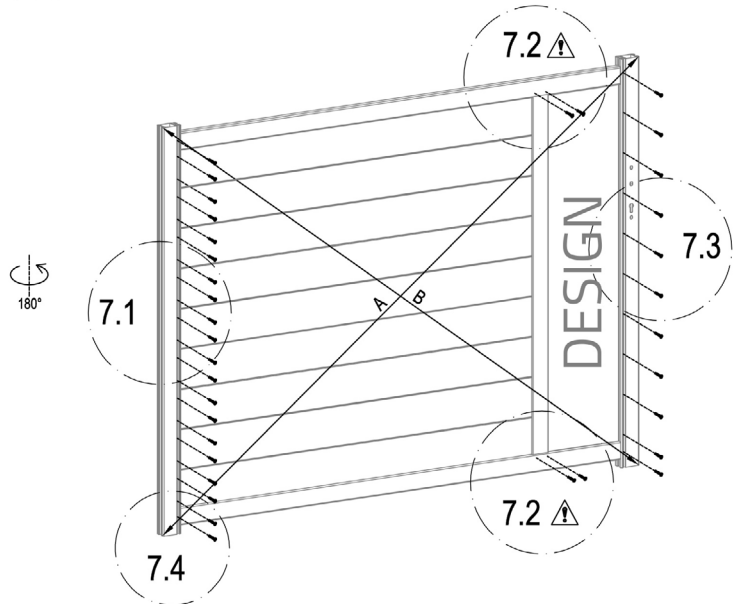

Part A.

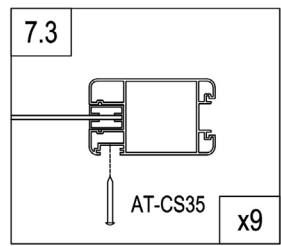
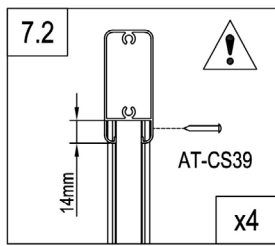
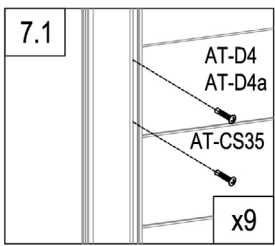

A=B



	AT-CS34	4
	AT-CS35	27
	AT-CS39	4

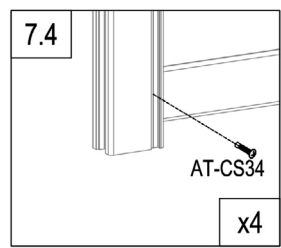

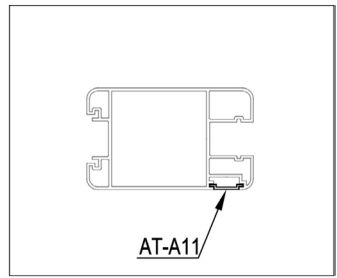
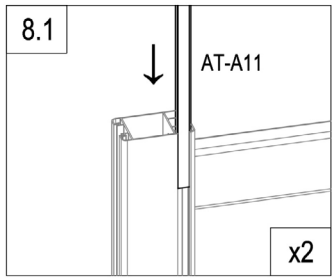
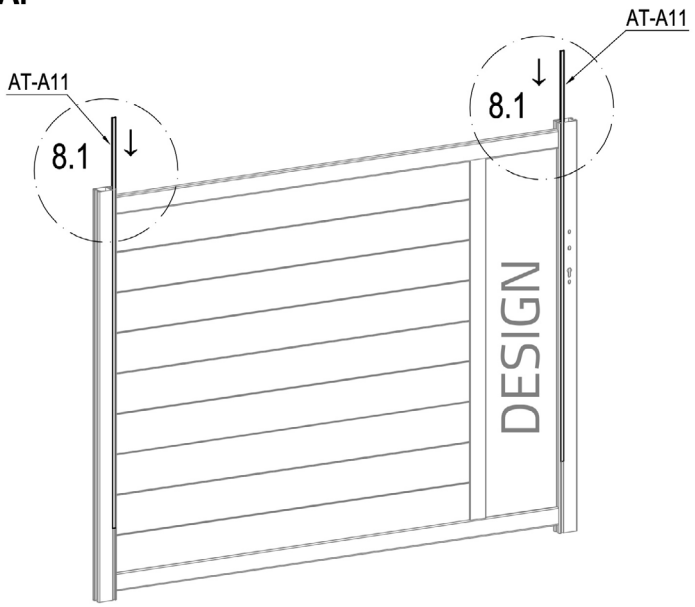

Part A.



	AT-A11	2
---	--------	---

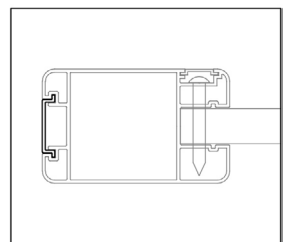
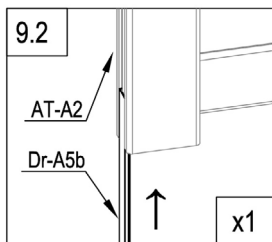
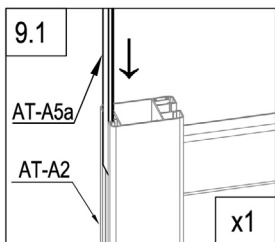
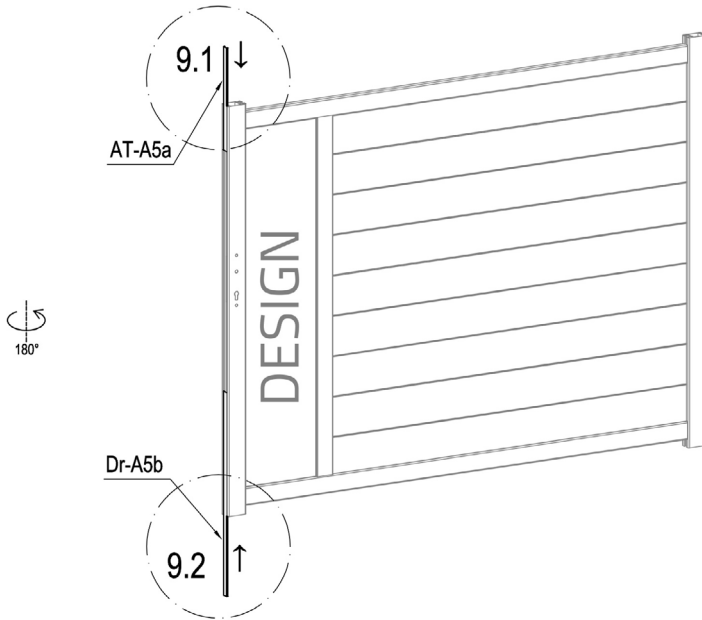

Part A.



	AT-A5a	1
	Dr-A5b	1

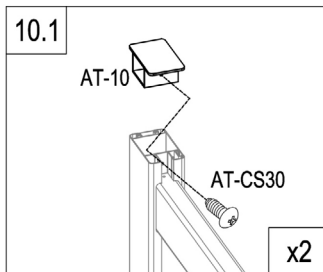
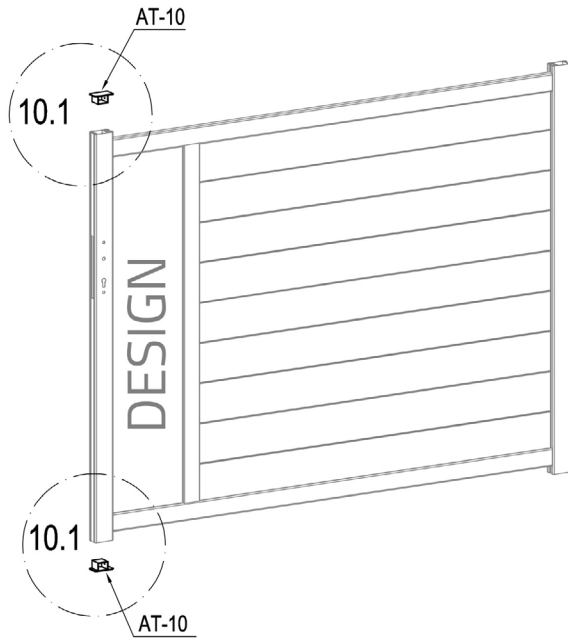

Part A.

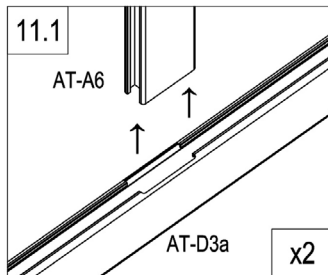
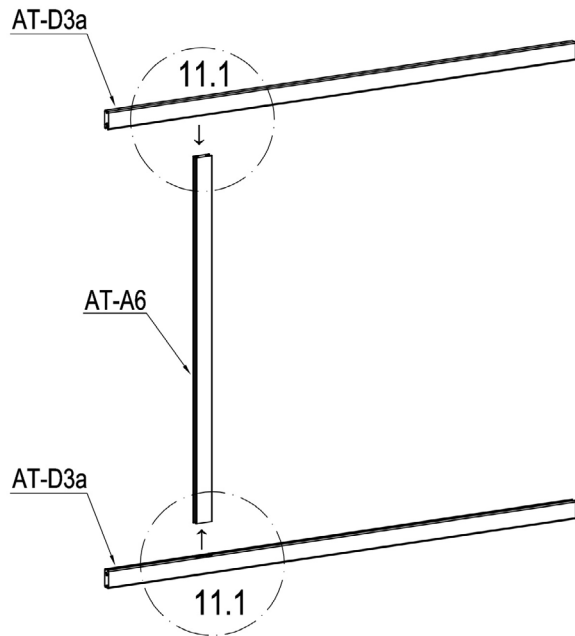

	AT-10	2
	AT-CS30	2

Part B.



	AT-A6	1
	AT-D3a	2

Part B.

EN :you can flip and switch the direction of this plate to personalize your gate

FR: vous pouvez retourner et changer la direction de cette plaque pour personnaliser votre portail

DE: Sie können dieses Schild umdrehen und die Richtung wechseln, um Ihr Tor zu personalisieren.

ES: puedes girar y cambiar la dirección de esta placa para personalizar tu puerta



PT: pode virar e mudar a direção desta placa para personalizar o seu portão

IT: potete capovolgere e cambiare la direzione di questa piastra per personalizzare il vostro cancello

NL: u kunt de richting van deze plaat omdraaien en veranderen om uw poort te verpersoonlijken...

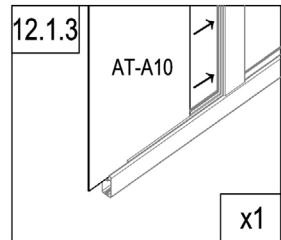
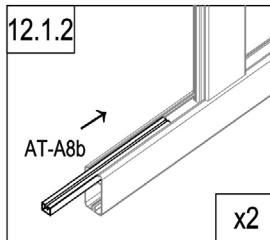
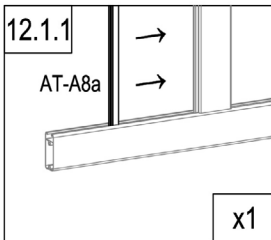
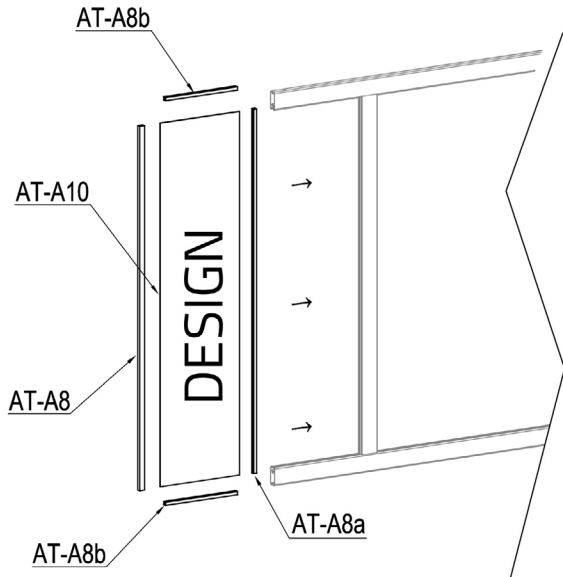
PL: można obrócić i przełączyć kierunek tej płyty, aby spersonalizować bramę.



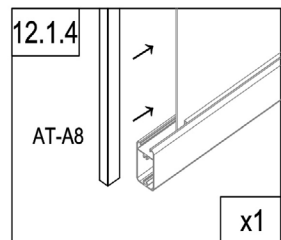

	AT-A8a	1
	AT-A8b	2
	AT-A10	1
	AT-A8	1



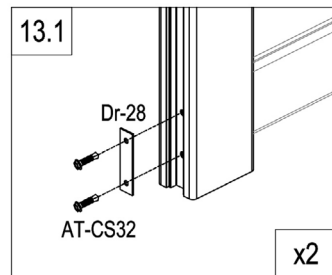
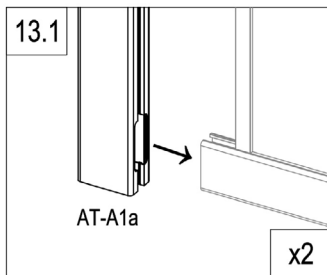
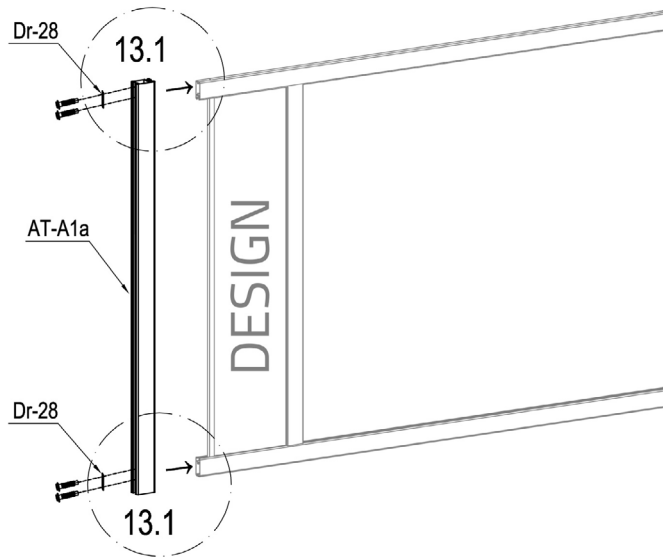

Part B.

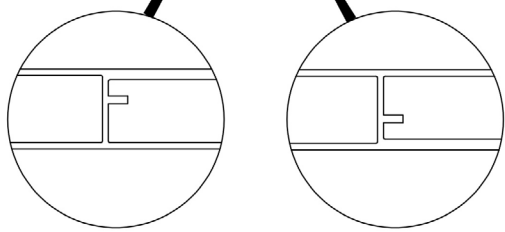
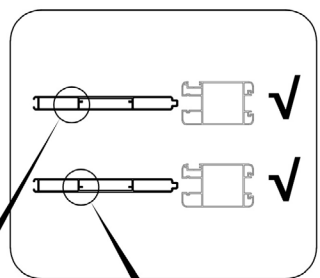
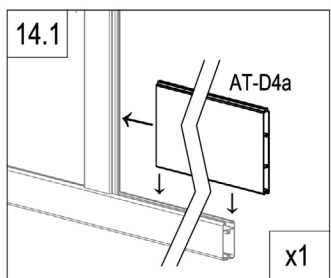
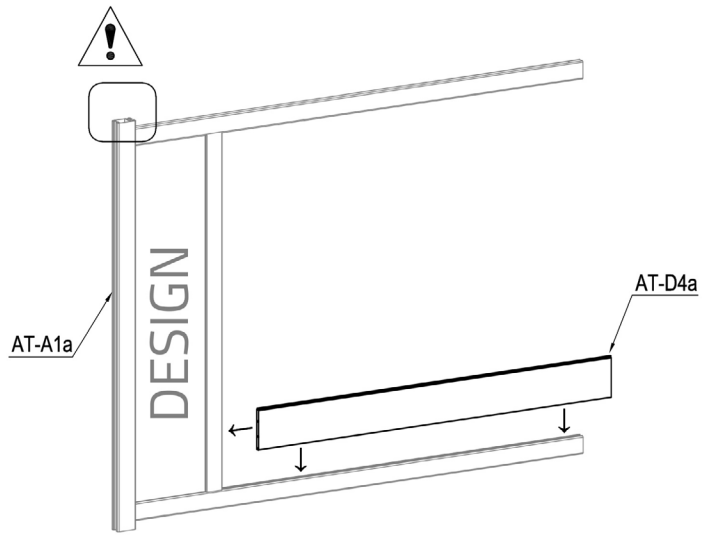

	AT-A1a	1
	Dr-28	2
	AT-CS32	4

Part B.



	AT-D4a	1
---	--------	---

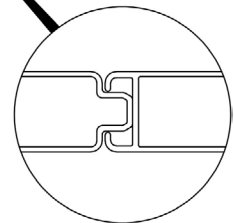
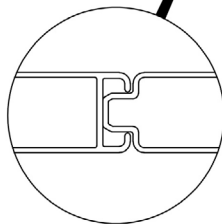
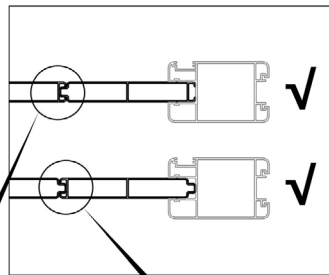
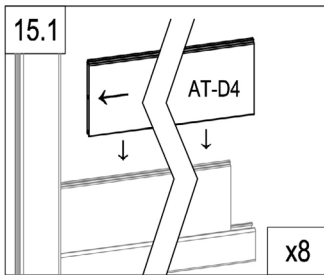
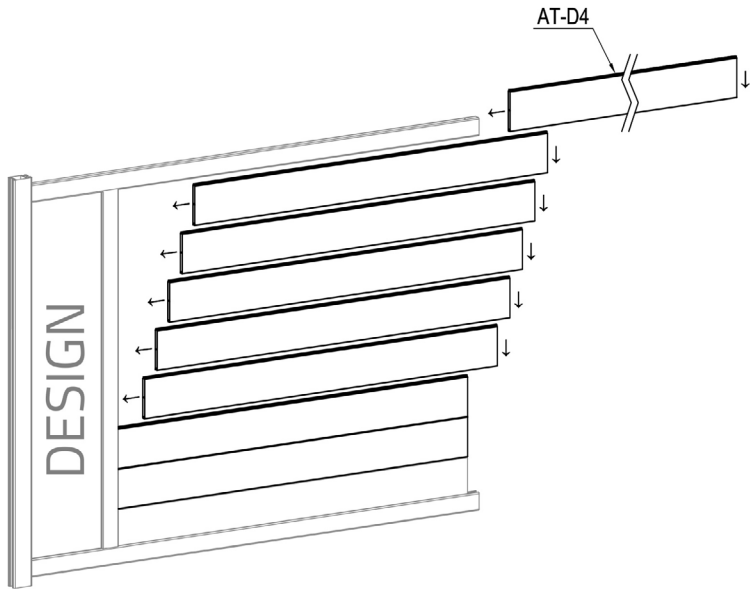

Part B.

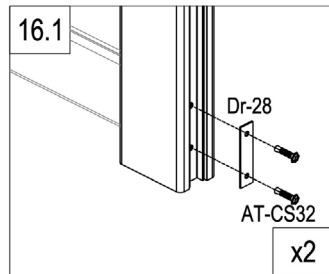
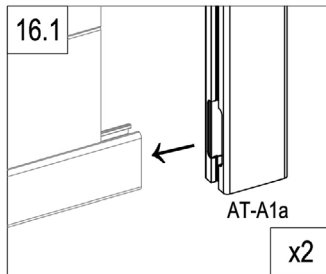
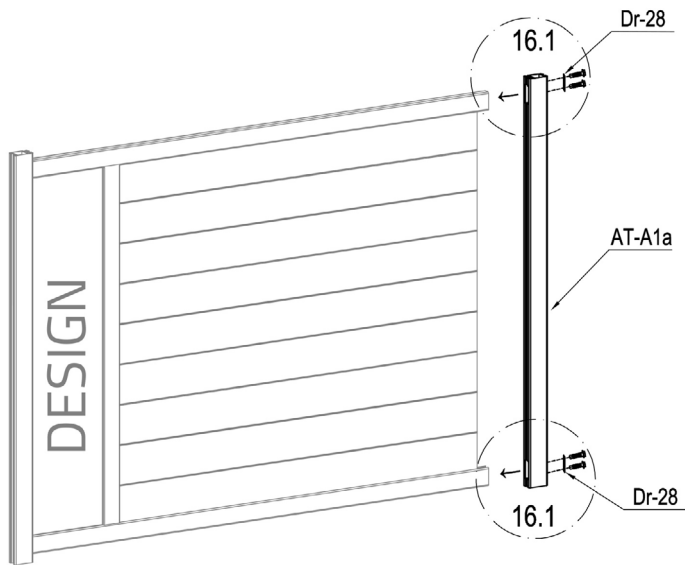

	AT-D4	8
---	-------	---

Part B.



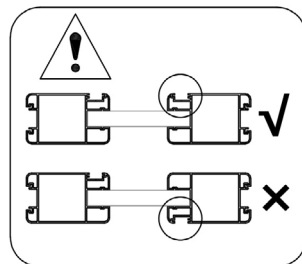

	AT-A1a	1
	Dr-28	2
	AT-CS32	4

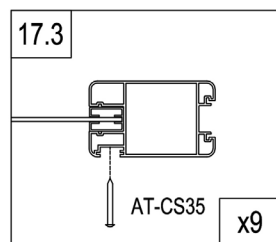
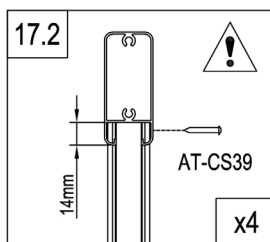
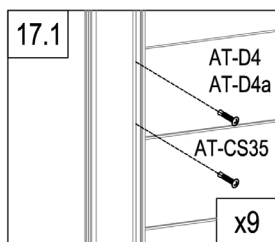
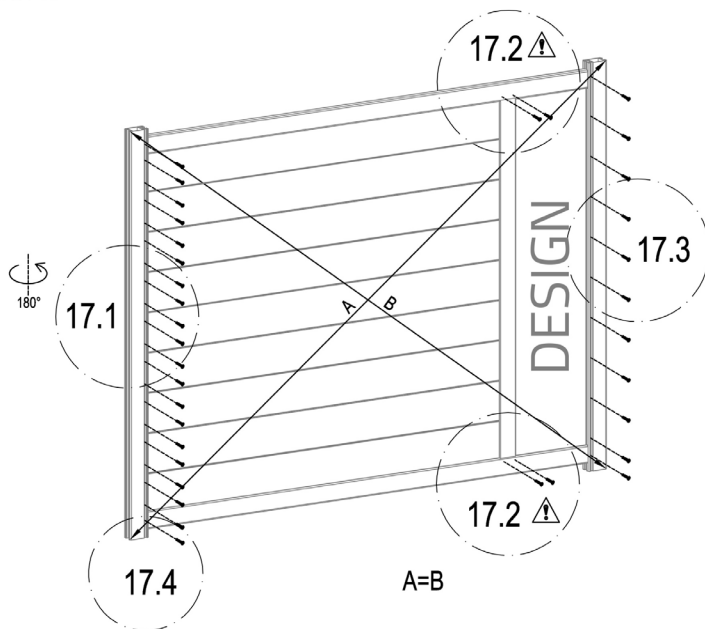

Part B.



	AT-CS34	4
	AT-CS35	27
	AT-CS39	4

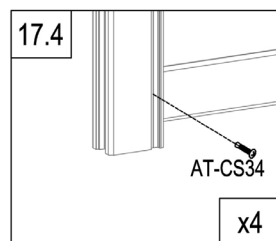

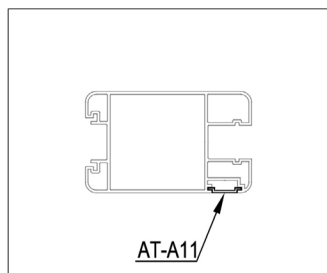
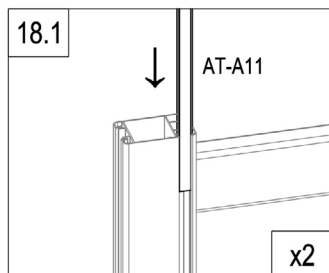
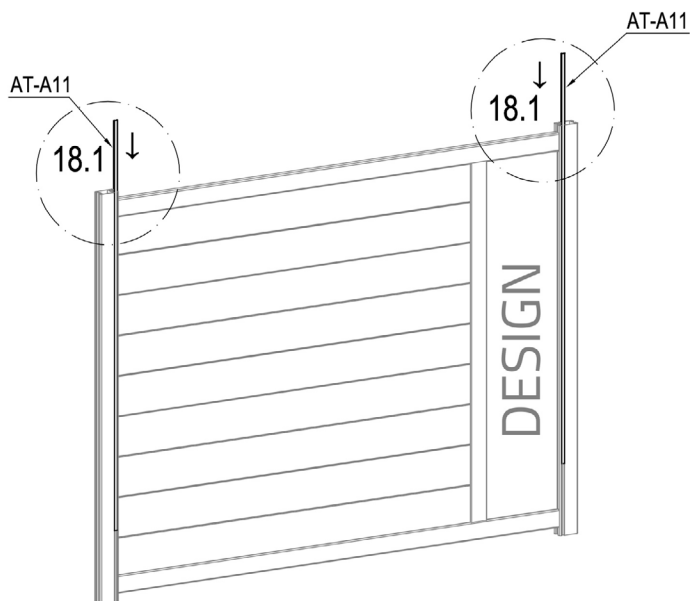

Part B.

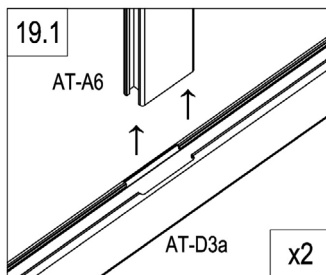
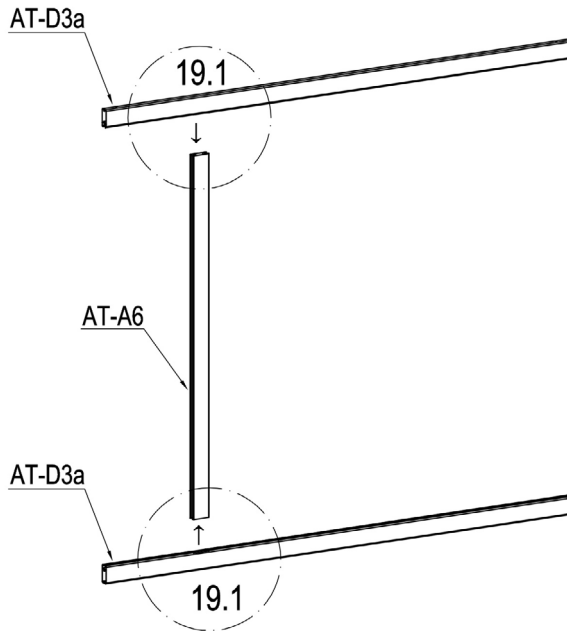

	AT-A11	2
---	--------	---

Part C.



	AT-A6	1
	AT-D3a	2

Part C.

EN :you can flip and switch the direction of this plate to personalize your gate

FR: vous pouvez retourner et changer la direction de cette plaque pour personnaliser votre portail

DE: Sie können dieses Schild umdrehen und die Richtung wechseln, um Ihr Tor zu personalisieren.

ES: puedes girar y cambiar la dirección de esta placa para personalizar tu puerta

PT: pode virar e mudar a direção desta placa para personalizar o seu portão

IT: potete capovolgere e cambiare la direzione di questa piastra per personalizzare il vostro cancello

NL: u kunt de richting van deze plaat omdraaien en veranderen om uw poort te verpersoonlijken...

PL: można obrócić i przełączyć kierunek tej płyty, aby personalizować bramę.

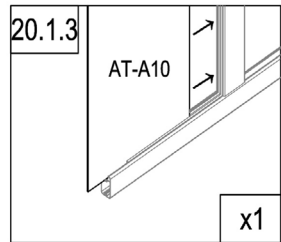
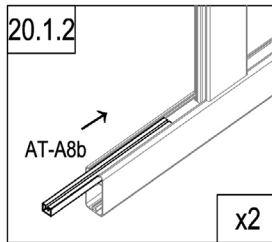
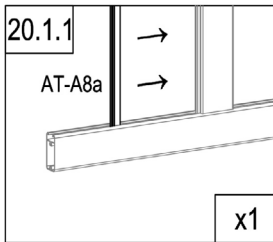
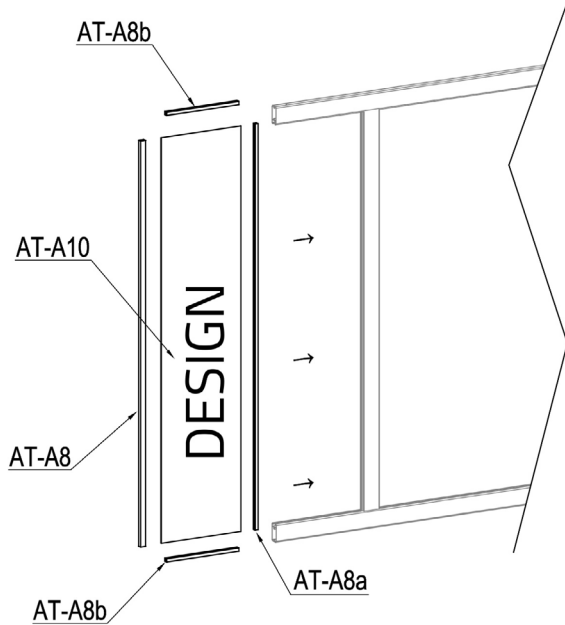

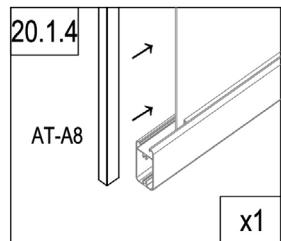

	AT-A8a	1
	AT-A8b	2
	AT-A10	1
	AT-A8	1



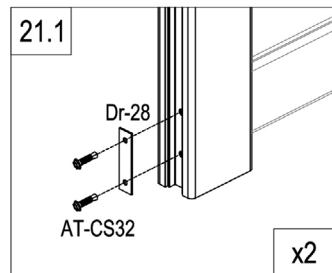
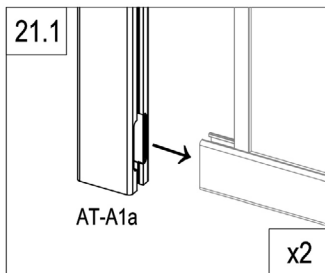
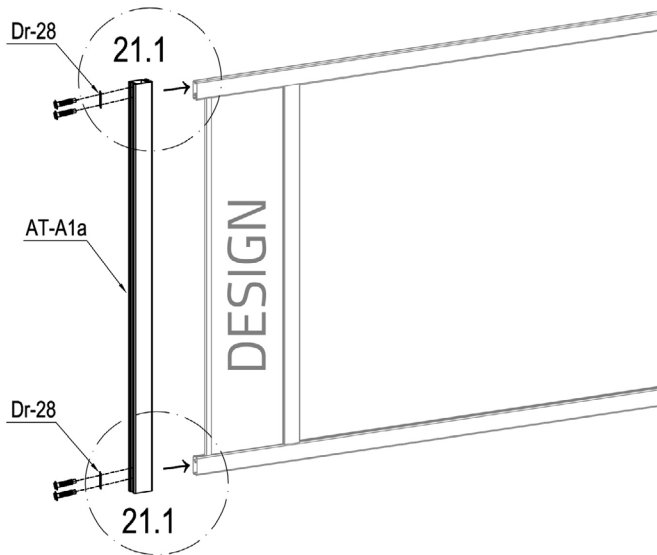

Part C.

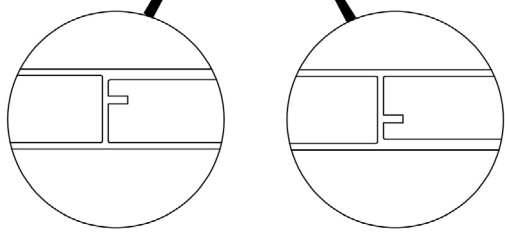
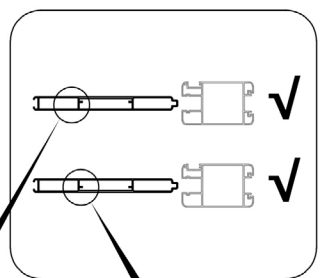
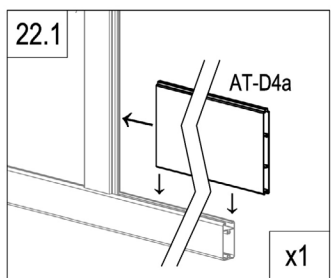
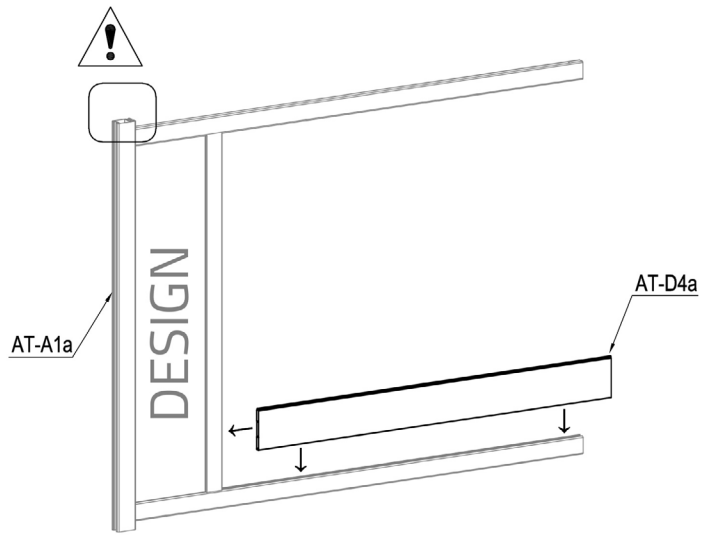

	AT-A1a	1
	Dr-28	2
	AT-CS32	4

Part C.



	AT-D4a	1
---	--------	---

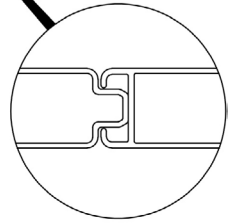
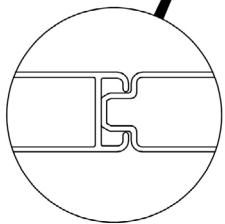
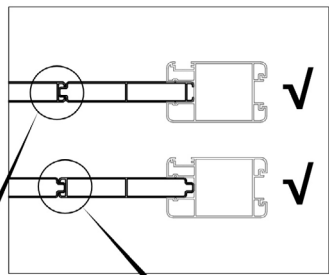
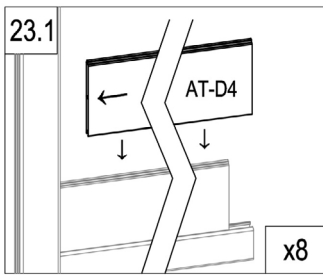
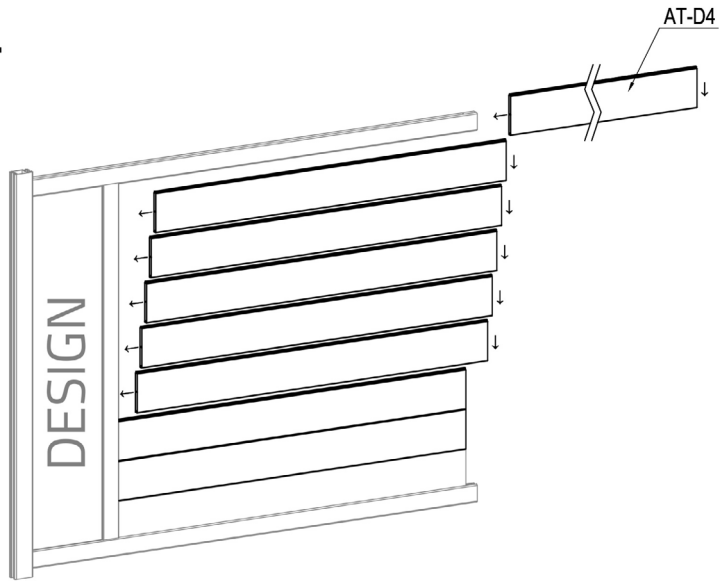

Part C.

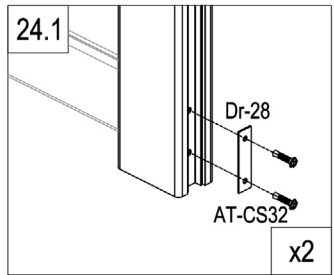
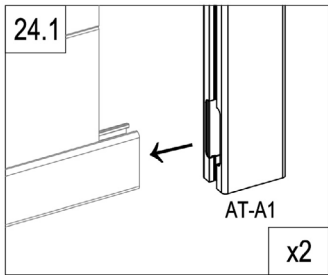
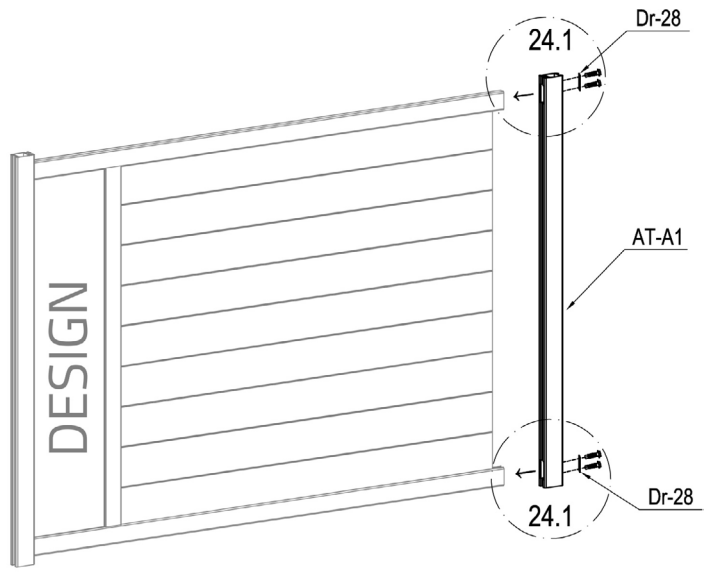

	AT-D4	8
---	-------	---

Part C.



	AT-A1	1
	Dr-28	2
	AT-CS32	4

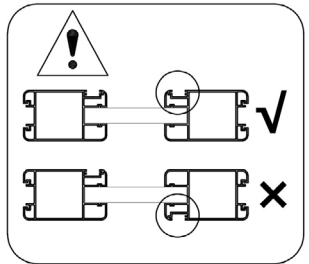

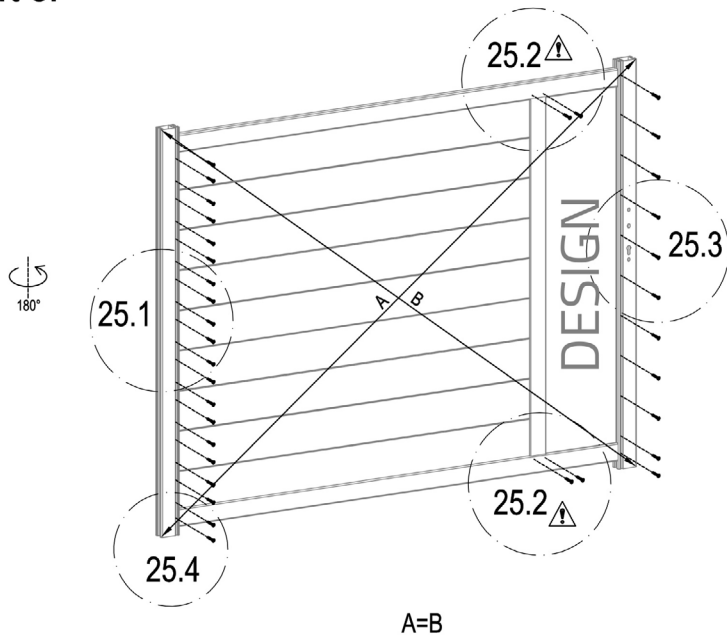

Part C.



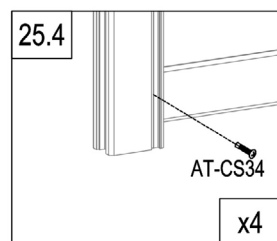
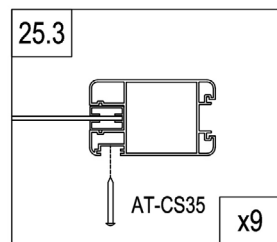
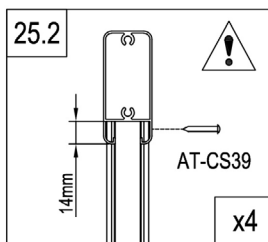
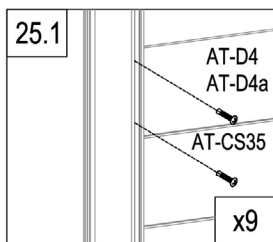

A=B

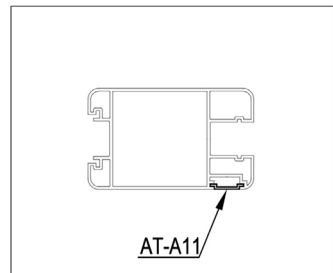
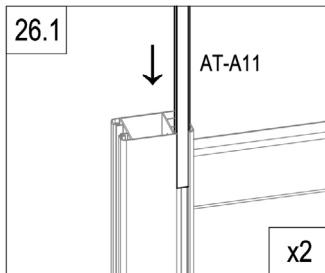
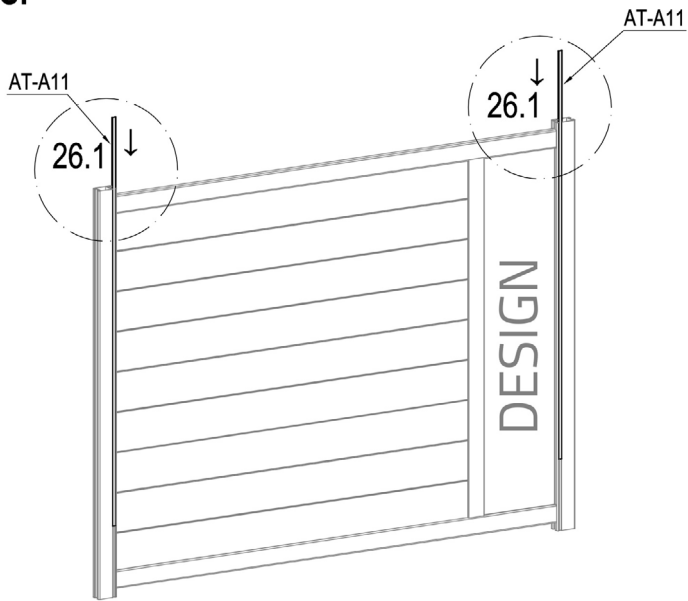

	AT-CS34	4
	AT-CS35	27
	AT-CS39	4

Part C.



	AT-A11	2
---	--------	---

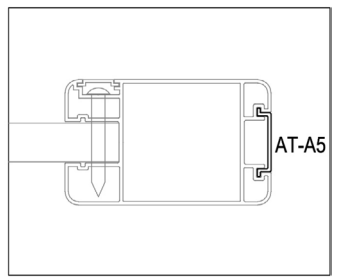
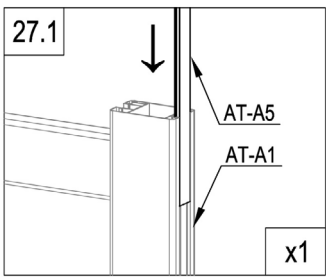
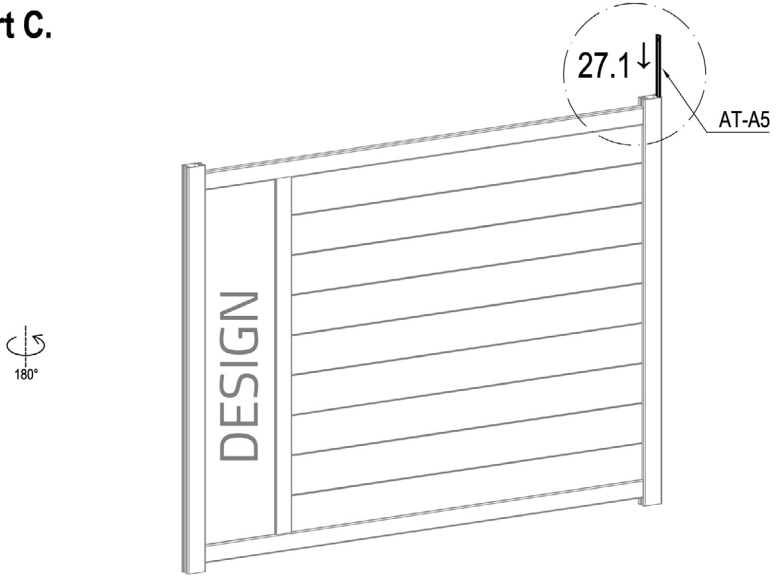

Part C.





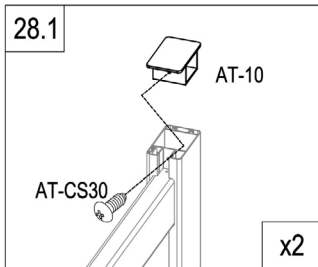
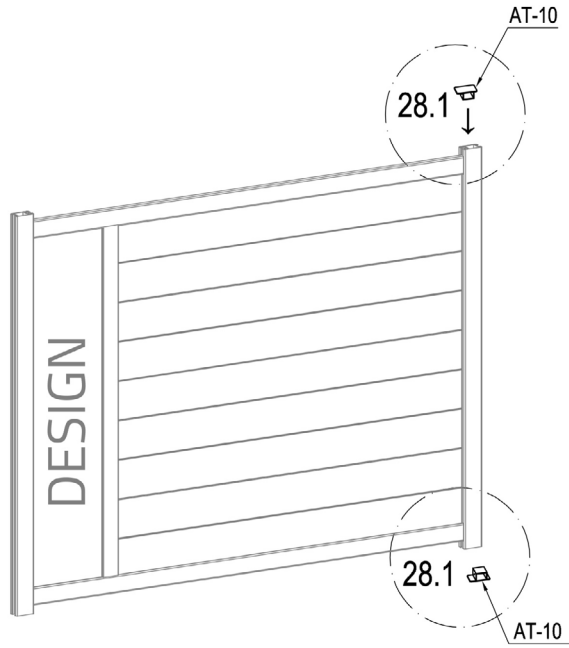

]	AT-A5	1
---	-------	---

Part C.

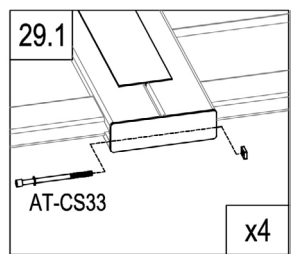
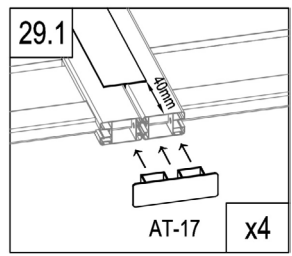
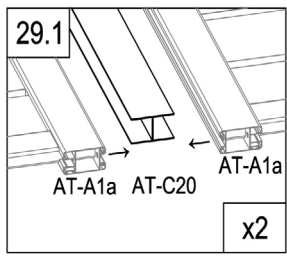
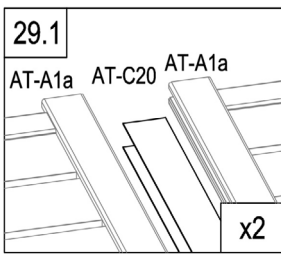
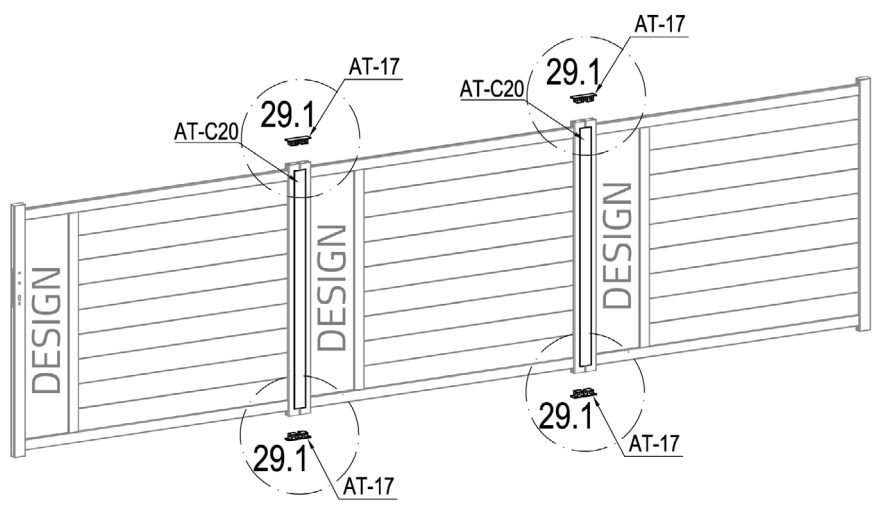



	AT-10	2
	AT-CS30	2

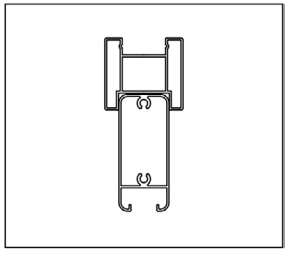
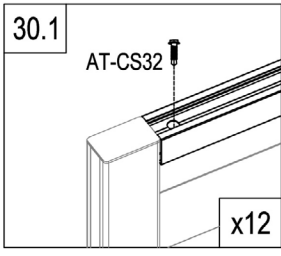
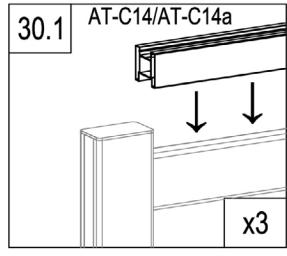
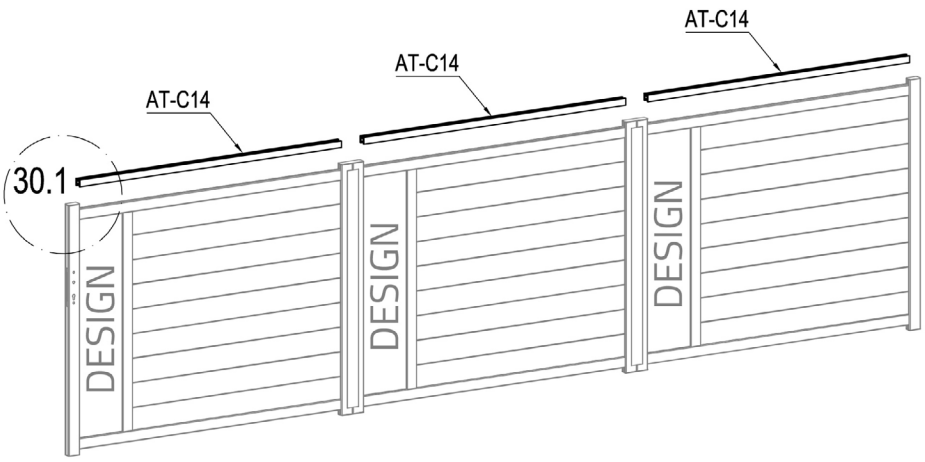

	AT-C20	2
	AT-17	4
	AT-CS33	4



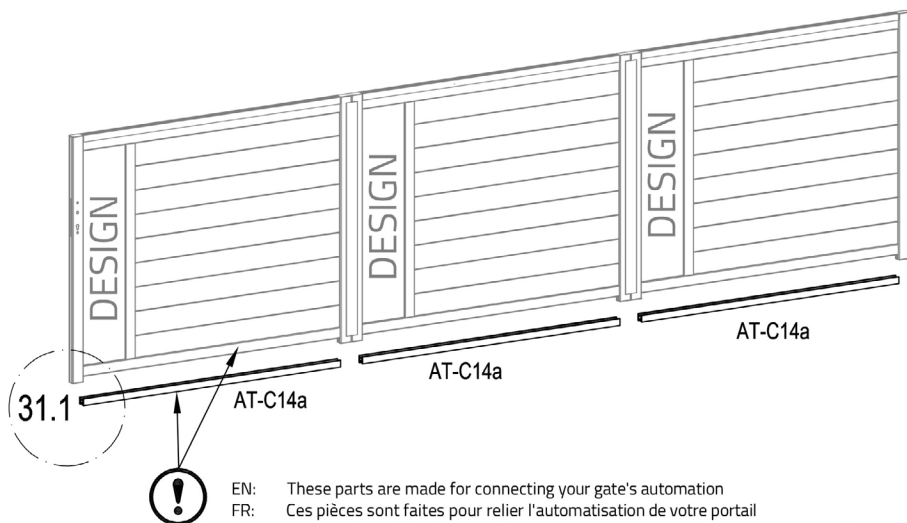

	AT-C14	3
	AT-CS32	12



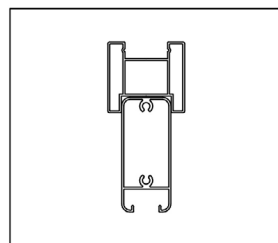
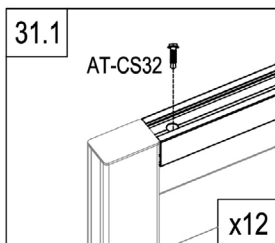
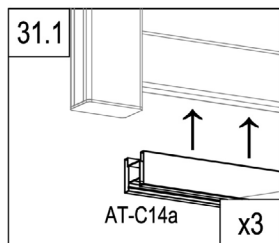

EN: These parts are made for connecting your gate's automation
 FR: Ces pièces sont faites pour relier l'automatisation de votre portail
 DE: Diese Teile sind für den Anschluss der Automatisierung Ihres Tores vorgesehen
 ES: Estas piezas están hechas para conectar la automatización de su puerta
 PT: Estas peças são feitas para ligar a automatização do seu portão
 IT: Queste parti sono realizzate per collegare l'automazione del vostro cancello
 NL: Deze onderdelen zijn gemaakt voor het aansluiten van de automatisering van uw poort.
 PL: Te części są wykonane do podłączenia automatyki bramy.

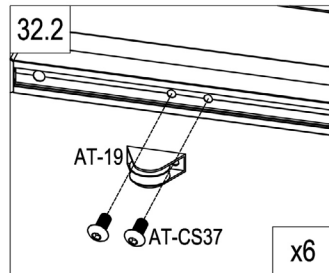
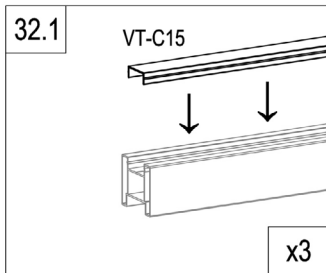
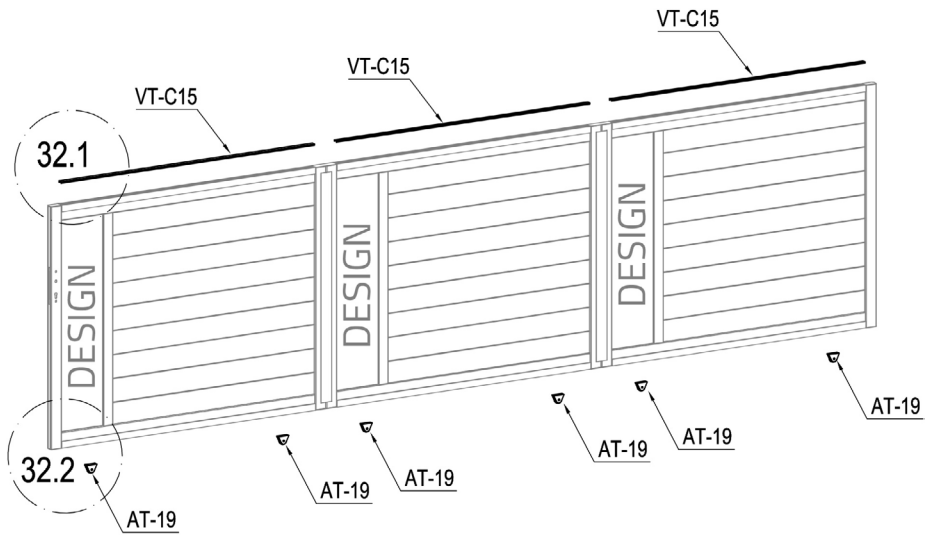

	AT-C14a	3
	AT-CS32	12



	VT-C15	3
	AT-19	6
	AT-CS37	12

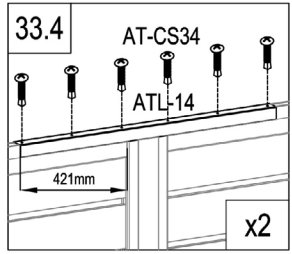
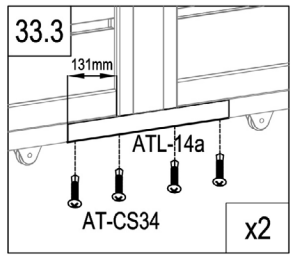
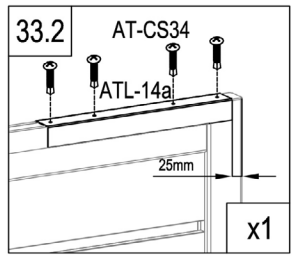
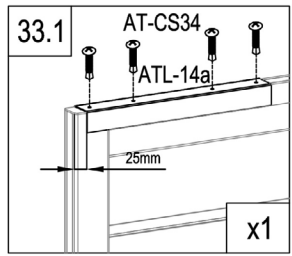
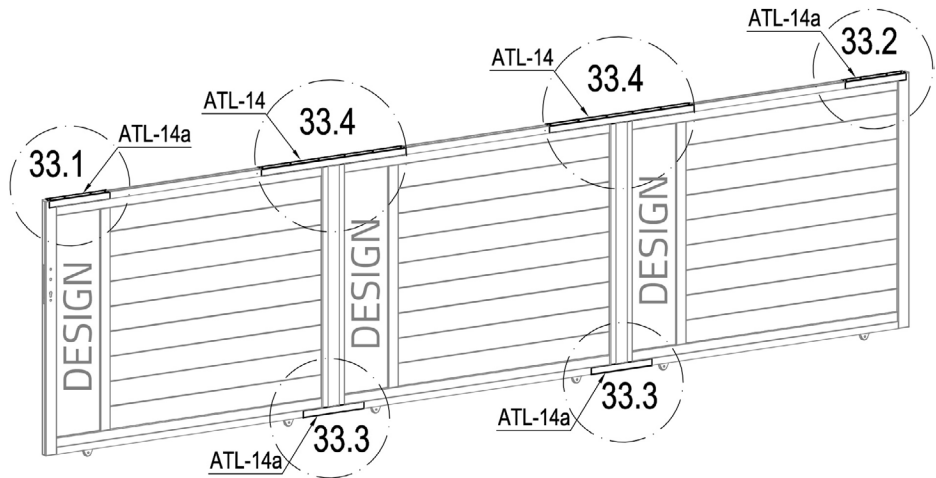

	ATL-14	2
	ATL-14a	4
	AT-CS34	28

Ext.

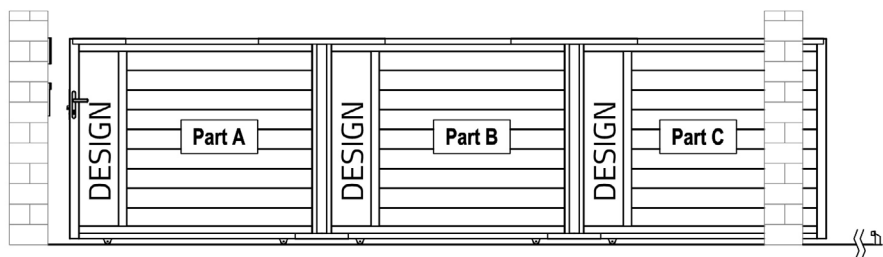

Int.

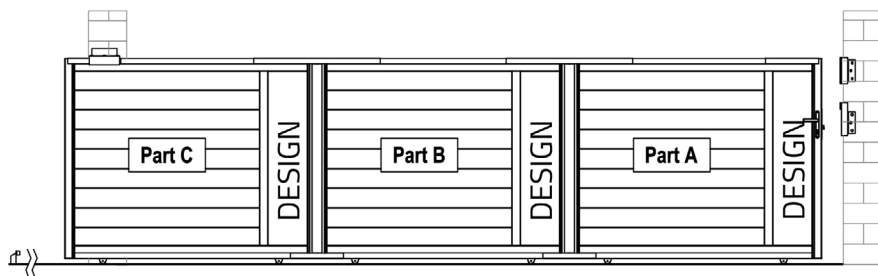

Ext.

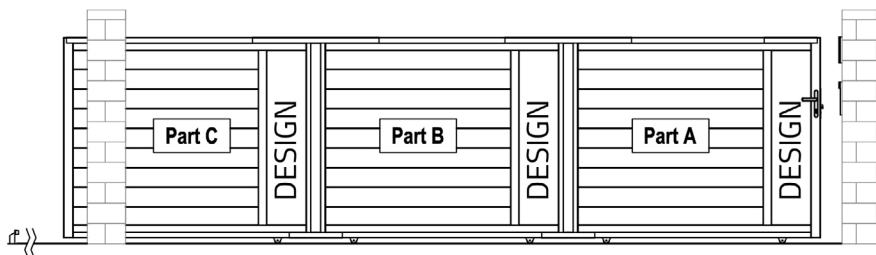

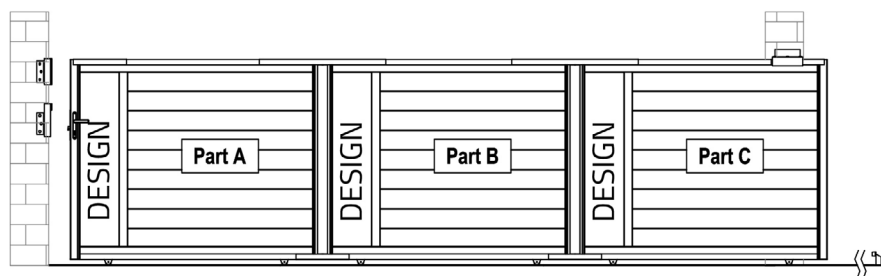

Int.

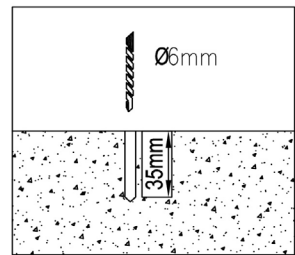
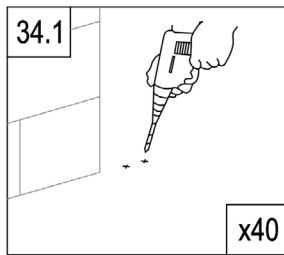
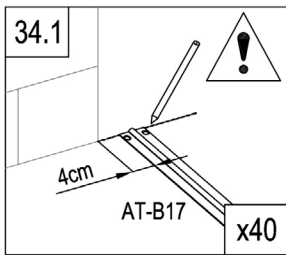
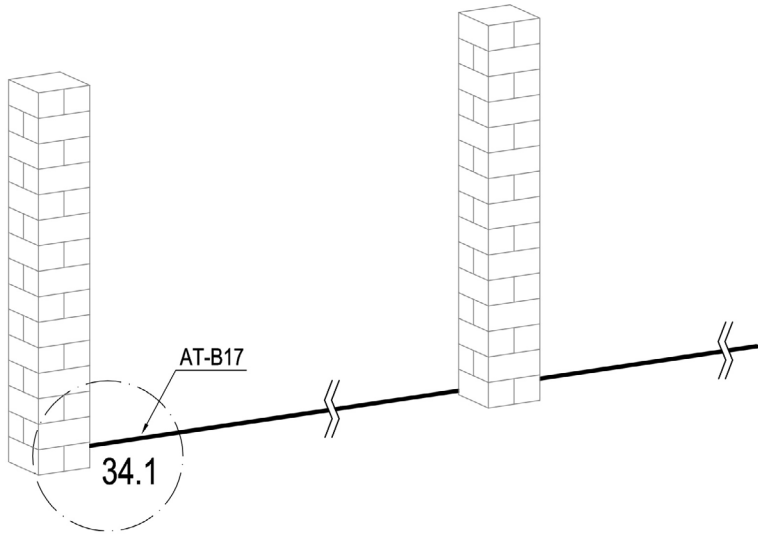

R

L



	AT-B17	8
	AT-CS38	80

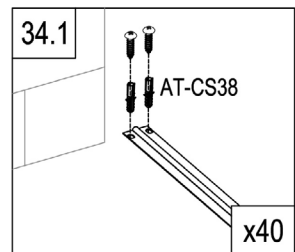

L

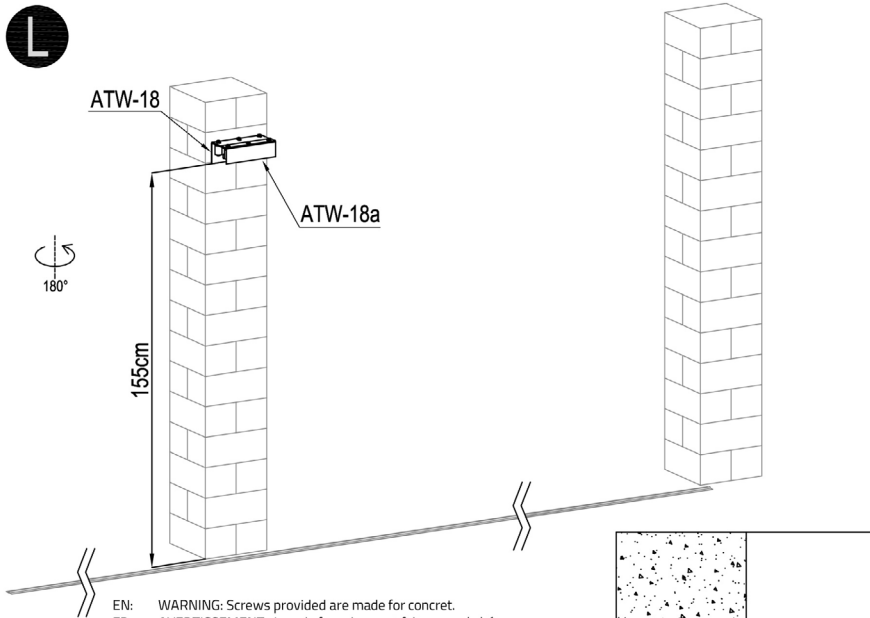

EN: WARNING: Screws provided are made for concret.
 FR: AVERTISSEMENT : Les vis fournies sont faites pour le béton.
 DE: WARNUNG: Die mitgelieferten Schrauben sind für Beton ausgelegt.
 ES: ADVERTENCIA: Los tornillos suministrados están hechos para el hormigón.
 IT: ATTENZIONE: Le viti fornite sono fatte per il calcestruzzo.
 NL: WAARSCHUWING: De bijgeleverde schroeven zijn gemaakt voor beton.
 PL: OSTRZEŻENIE: Dostarczone śruby są przeznaczone do betonu.
 PT: AVISO: Os parafusos fornecidos são feitos para betão.

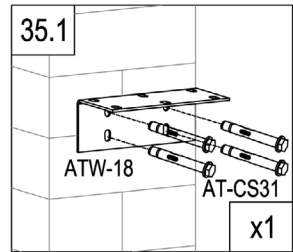
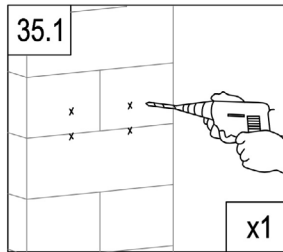
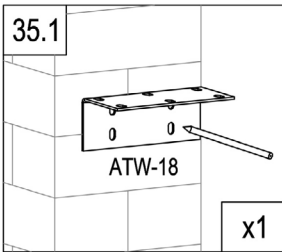
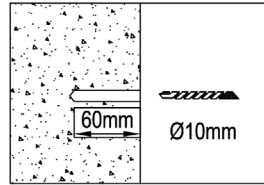

	ATW-18	1
	ATW-18a	1
	AT-20	6
	AT-CS31	4

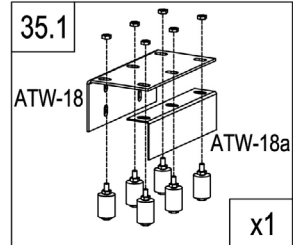
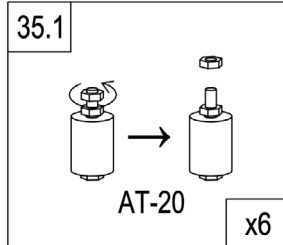

L

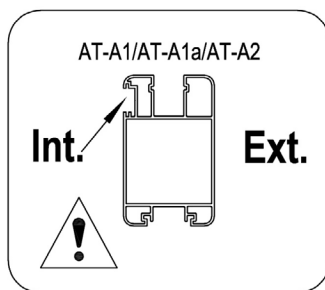
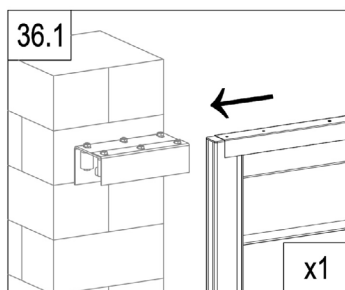
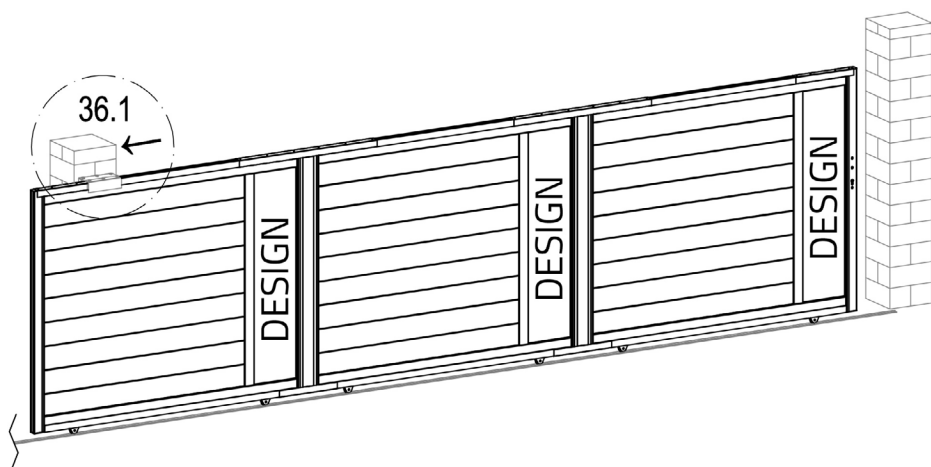

L

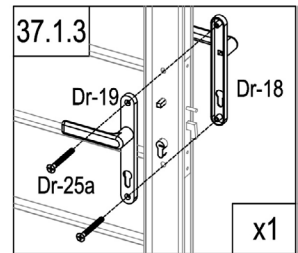
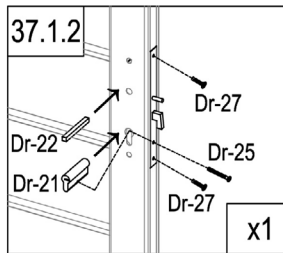
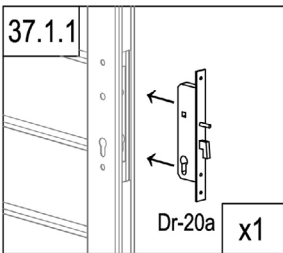
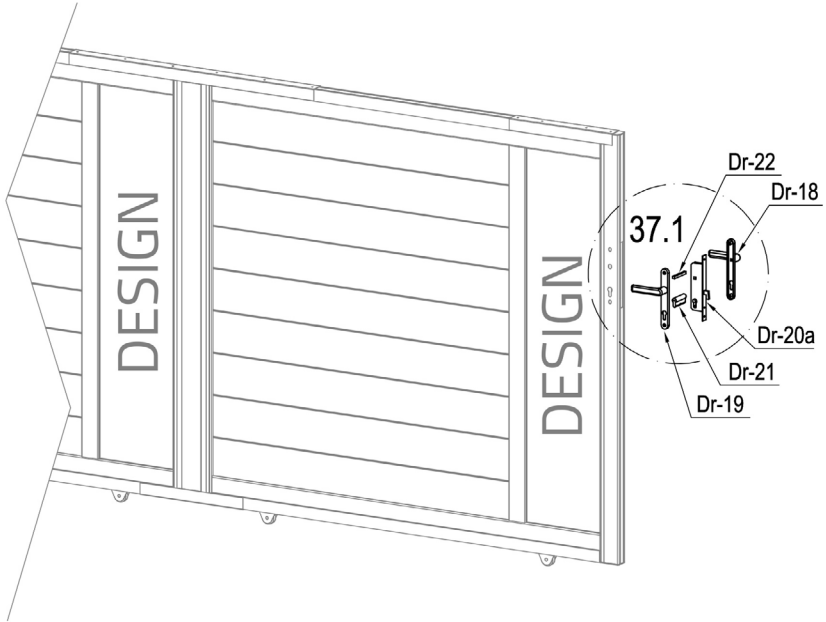

	Dr-20a	1
	Dr-21	1
	Dr-22	1
	Dr-25	1

	Dr-18	1
	Dr-19	1
	Dr-25a	2
	Dr-27	2



EN: WARNING: Screws provided are made for concret.
 FR: AVERTISSEMENT : Les vis fournies sont faites pour le béton.
 DE: WARNUNG: Die mitgelieferten Schrauben sind für Beton ausgelegt.
 ES: ADVERTENCIA: Los tornillos suministrados están hechos para el hormigón.
 IT: ATTENZIONE: Le viti fornite sono fatte per il calcestruzzo.
 NL: WAARSCHUWING: De bijgeleverde schroeven zijn gemaakt voor beton.
 PL: OSTRZEŻENIE: Dostarczone śruby są przeznaczone do betonu.
 PT: AVISO: Os parafusos fornecidos são feitos para betão.

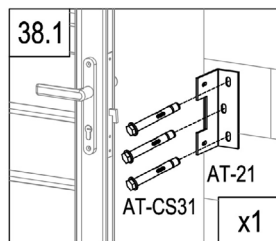
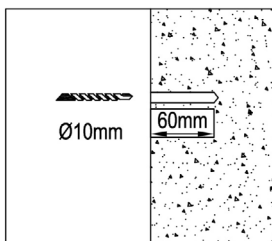
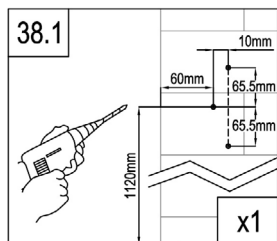
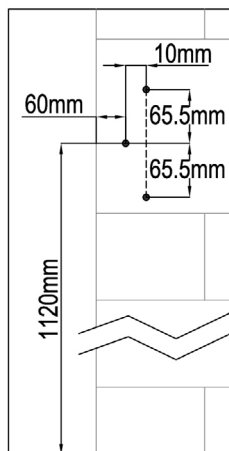
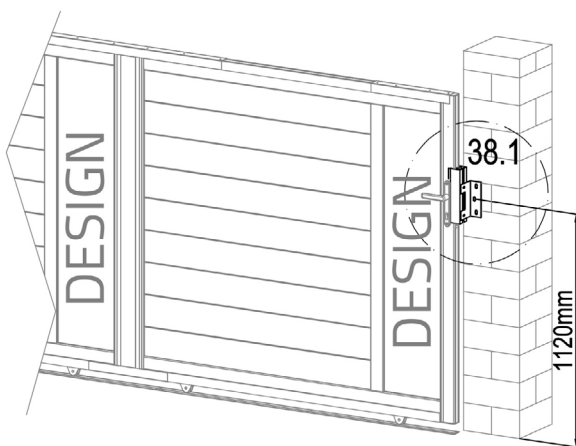

	AT-16	1
	AT-21	1
	AT-CS36	2
	AT-CS31	3
	AT-22J	3

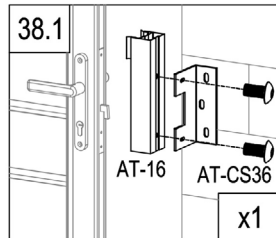
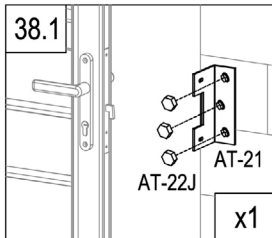

L

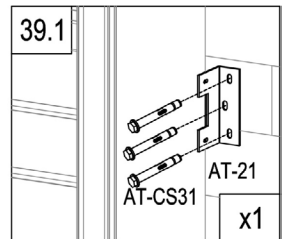
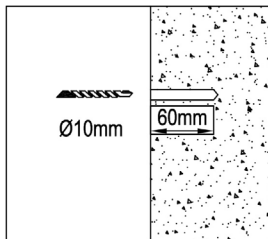
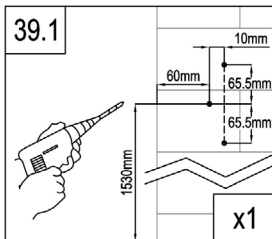
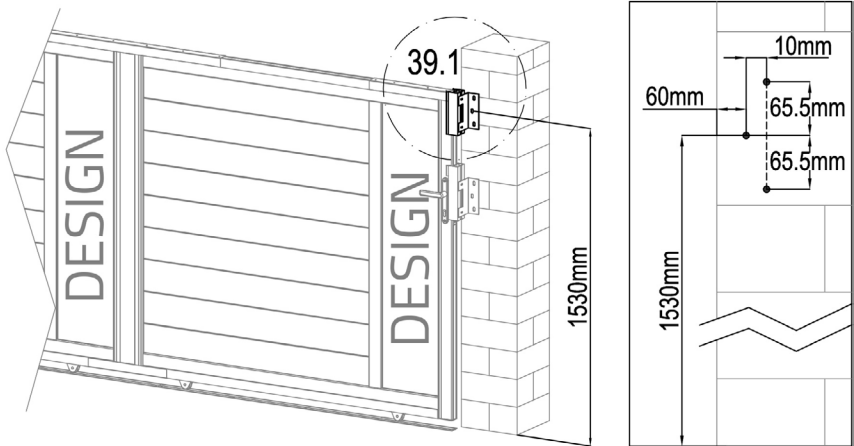

	AT-16a	1
	AT-21	1
	AT-CS36	2
	AT-CS31	3
	AT-22J	3

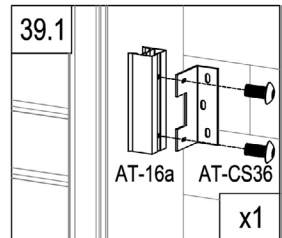
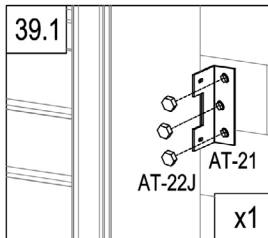

L

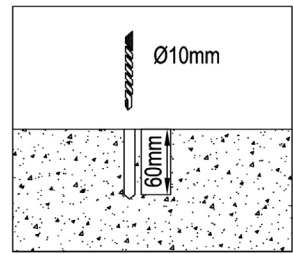
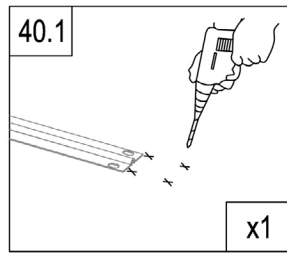
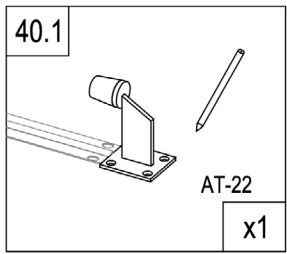
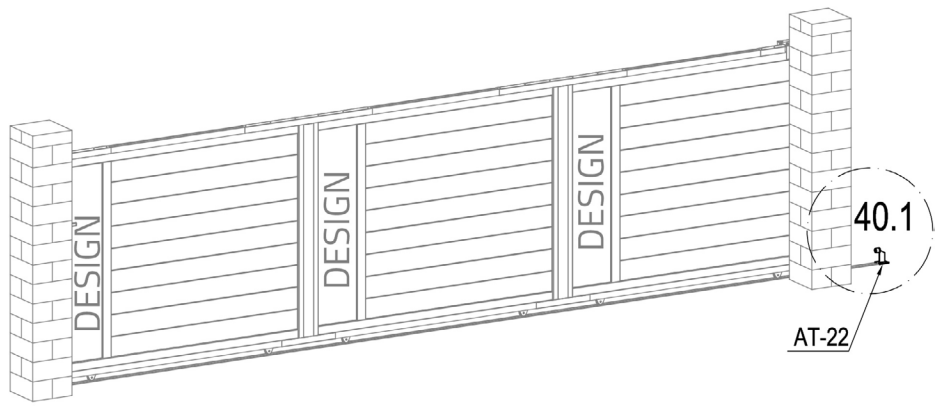

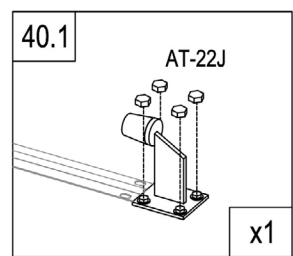
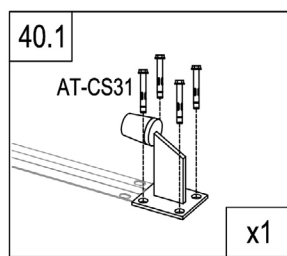

	AT-22	1
	AT-CS31	4
	AT-22J	4

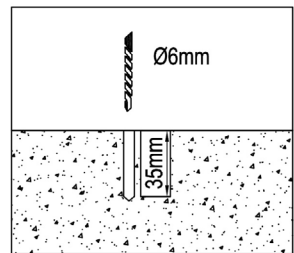
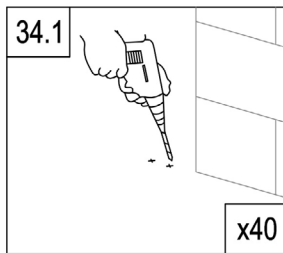
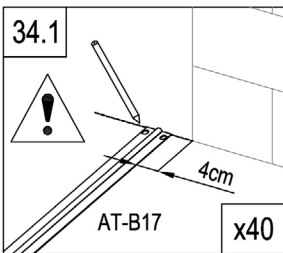
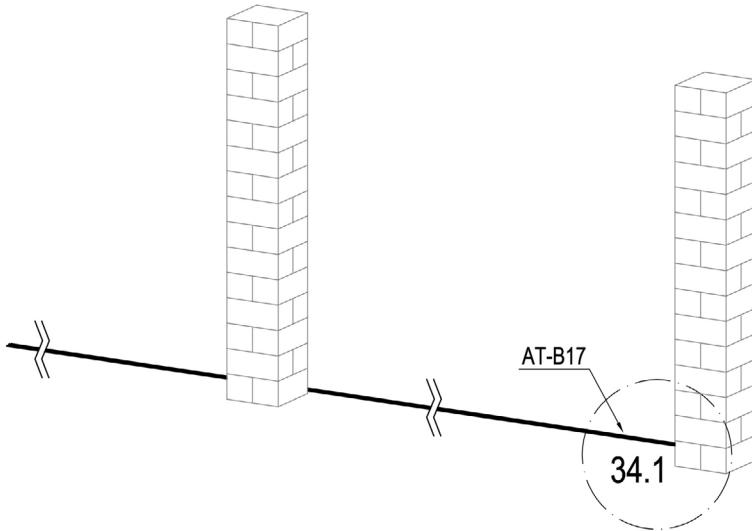

R



	AT-B17	8
	AT-CS38	80

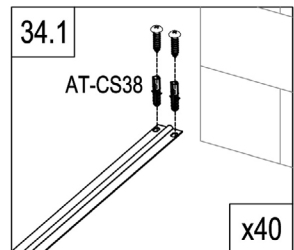

R

180°

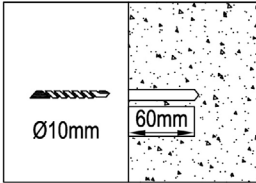
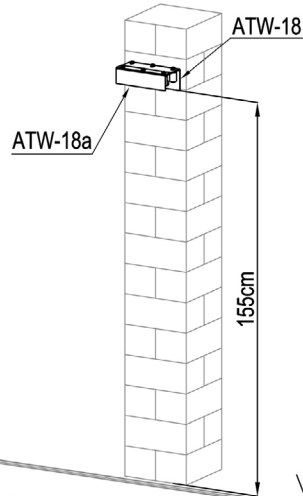

EN: WARNING: Screws provided are made for concret.
 FR: AVERTISSEMENT : Les vis fournies sont faites pour le béton.
 DE: WARNUNG: Die mitgelieferten Schrauben sind für Beton ausgelegt.
 ES: ADVERTENCIA: Los tornillos suministrados están hechos para el hormigón.
 IT: ATTENZIONE: Le viti fornite sono fatte per il calcestruzzo.
 NL: WAARSCHUWING: De bijgeleverde schroeven zijn gemaakt voor beton.
 PL: OSTRZEŻENIE: Dostarczone śruby są przeznaczone do betonu.
 PT: AVISO: Os parafusos fornecidos são feitos para betão.

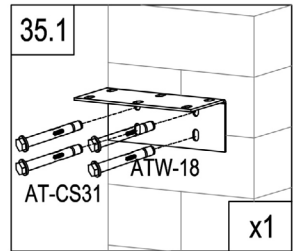
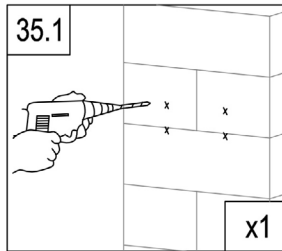
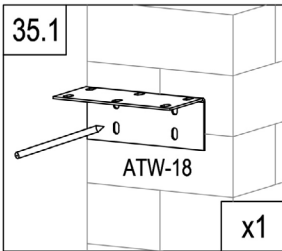

	ATW-18	1
	ATW-18a	1
	AT-20	6
	AT-CS31	4

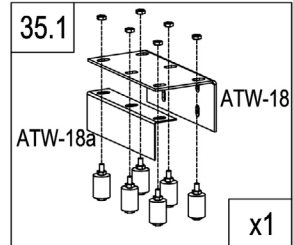
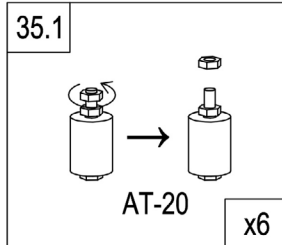

R

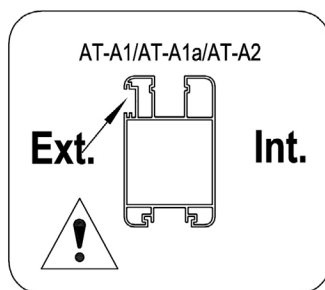
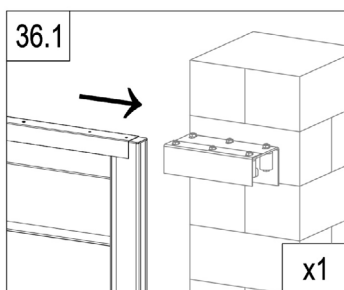
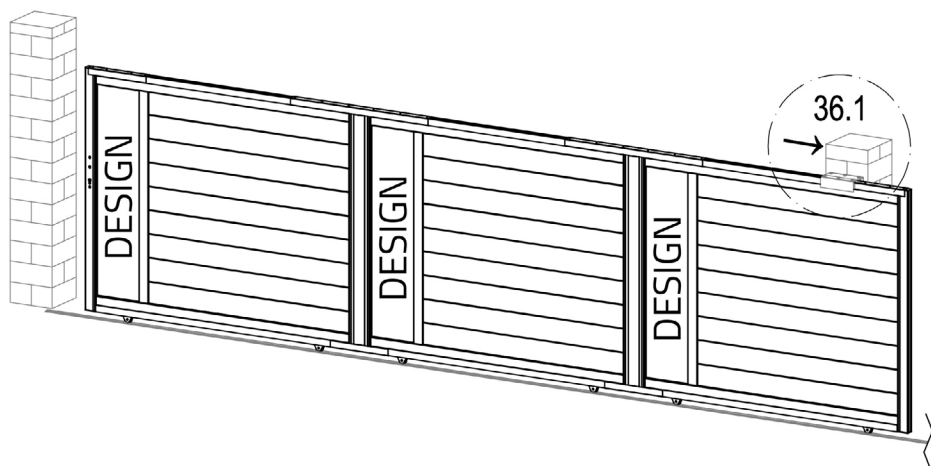

R

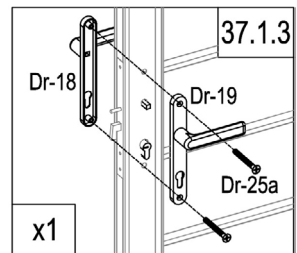
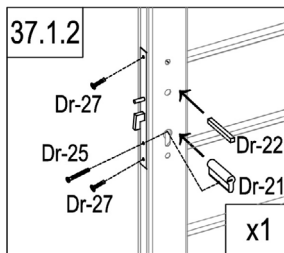
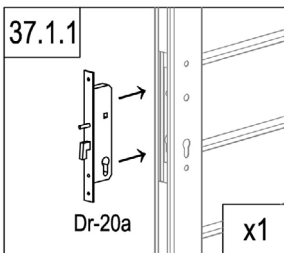
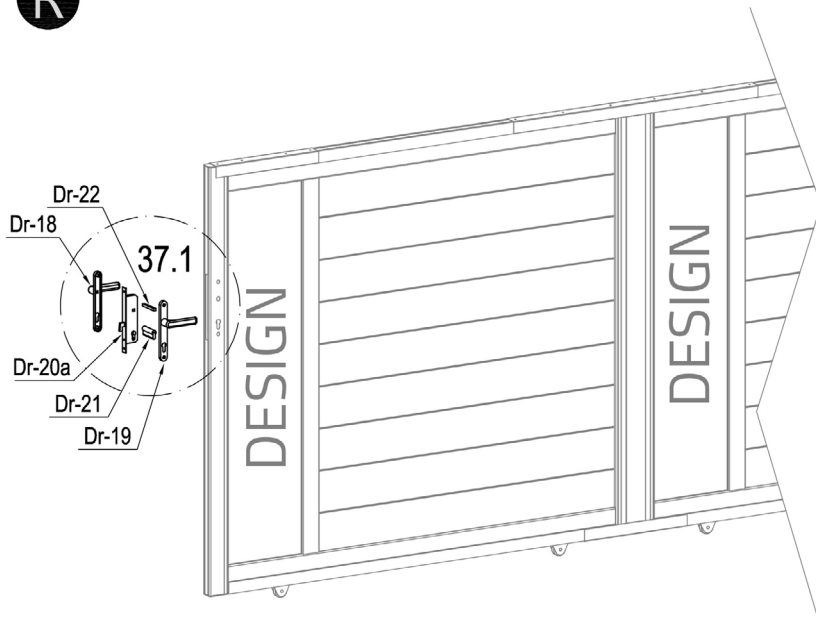

	Dr-20a	1
	Dr-21	1
	Dr-22	1
	Dr-25	1

	Dr-18	1
	Dr-19	1
	Dr-25a	2
	Dr-27	2



EN: WARNING: Screws provided are made for concret.
 FR: AVERTISSEMENT : Les vis fournies sont faites pour le béton.
 DE: WARNUNG: Die mitgelieferten Schrauben sind für Beton ausgelegt.
 ES: ADVERTENCIA: Los tornillos suministrados están hechos para el hormigón.
 IT: ATTENZIONE: Le viti fornite sono fatte per il calcestruzzo.
 NL: WAARSCHUWING: De bijgeleverde schroeven zijn gemaakt voor beton.
 PL: OSTRZEŻENIE: Dostarczone śruby są przeznaczone do betonu.
 PT: AVISO: Os parafusos fornecidos são feitos para betão.

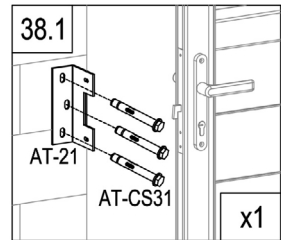
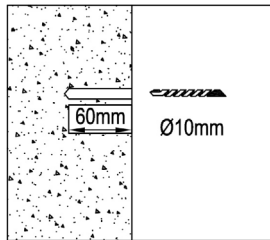
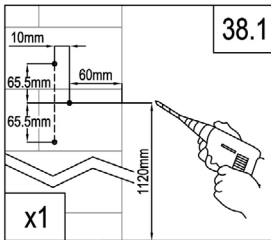
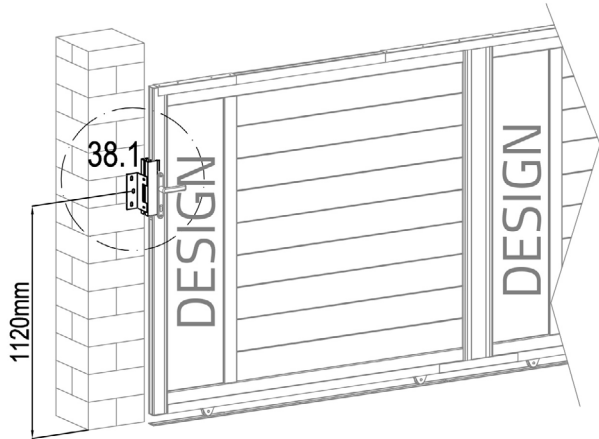
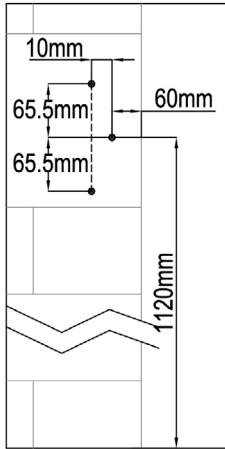

	AT-16	1
	AT-21	1
	AT-CS36	2
	AT-CS31	3
	AT-22J	3

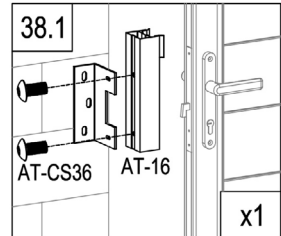
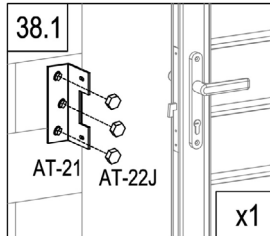

R

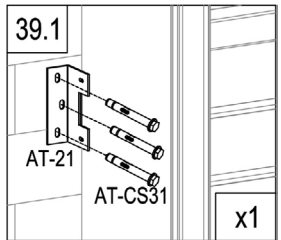
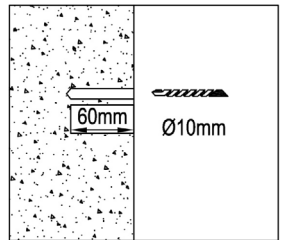
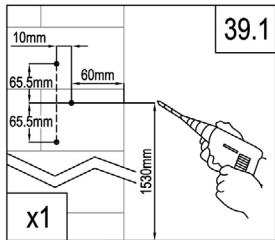
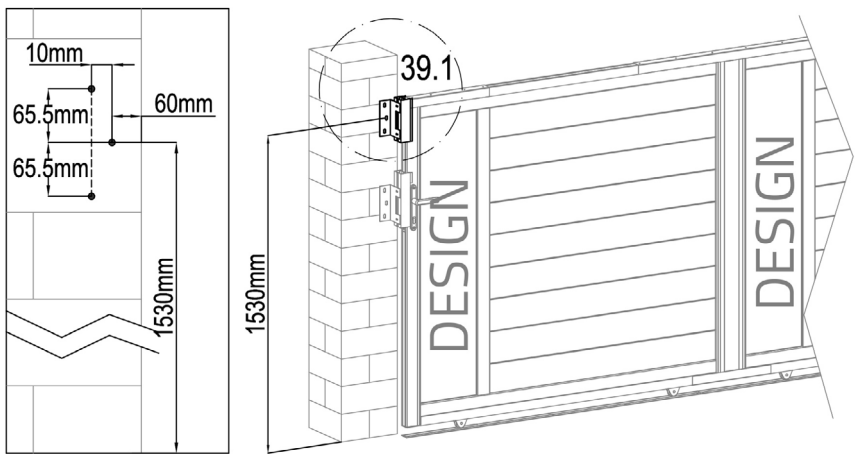

	AT-16a	1
	AT-21	1
	AT-CS36	2
	AT-CS31	3
	AT-22J	3

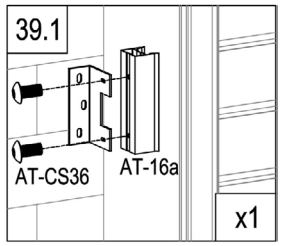
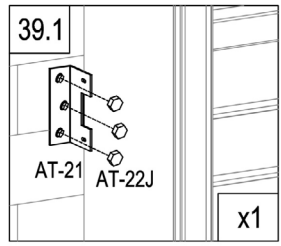

R

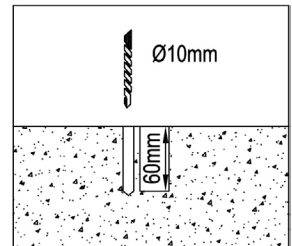
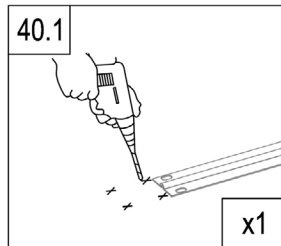
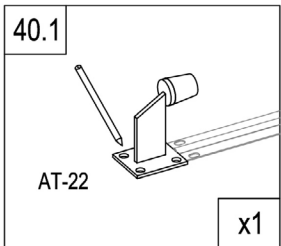
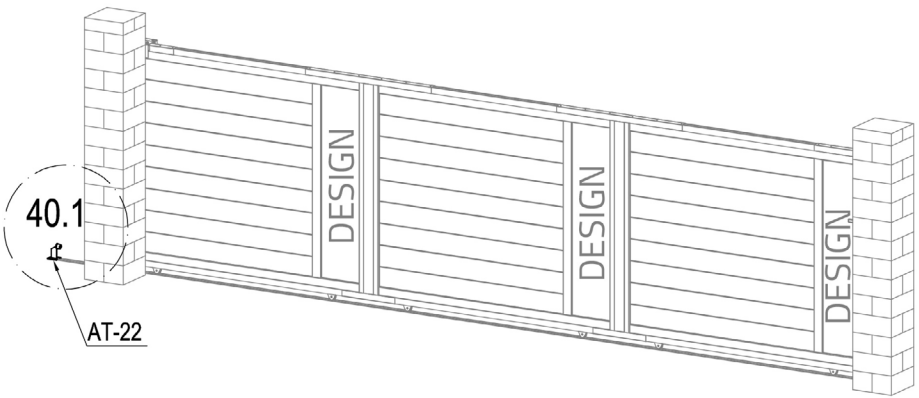

	AT-22	1
	AT-CS31	4
	AT-22J	4

