

CASANOVO

LIFE 500C140

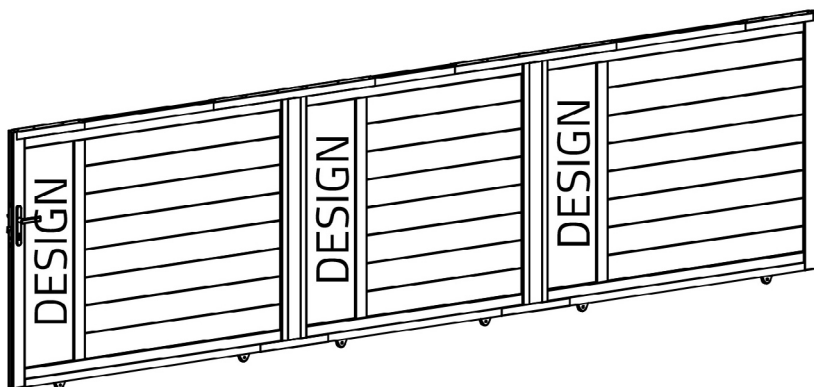

COM-001079 [x1]

COM-001081 [x1]

COM-000287 [x1]

COM-001080 [x1]

COM-001082 [x1]

COM-000289 [x1]



INSTRUCTION MANUAL / NOTICE DE MONTAGE / MONTAGEANLEITUNG / MANUAL DE MONTAJE / MANUAL DE MONTAGEM / MANUALE DI MONTAGGIO /
MONTAGEHANDLEIDING / INSTRUKCJA MONTAŻU / KÄYTTÖOHJEET / BRUKSANVISNING / BRUGSANVISNING / INSTRUCȚIUNI DE ASAMBLARE /
NAVODILA ZA SESTAVLJANJE / NÁVOD NA MONTÁŽ / ÖSSZESZERELÉSI ÚTMUTATÓ / NÁVOD K MONTÁŽI / UPUTE ZA INSTALACIJU /
ΟΔΗΓΙΕΣ ΣΥΝΑΡΜΟΛΟΓΗΣΗΣ / SURINKIMO INSTRUKCIJOS / MONTĀŽAS INSTRUKCIJAS

Ext.

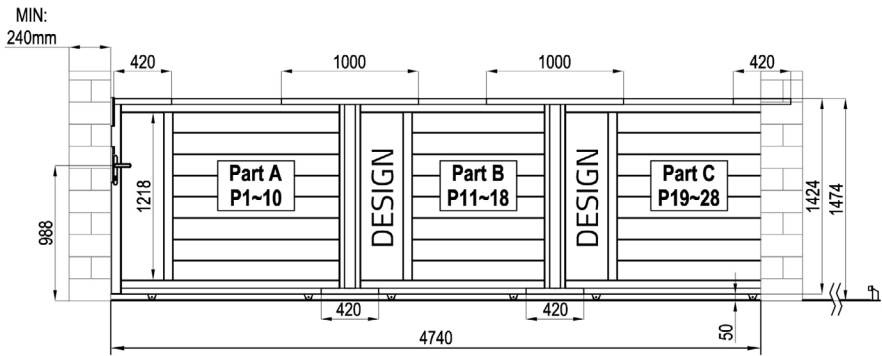

Int.

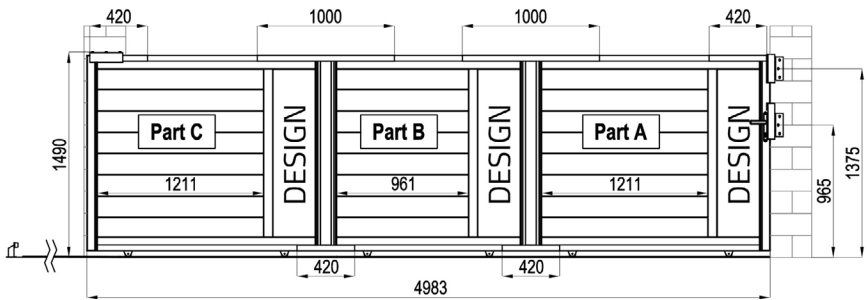

Part A.

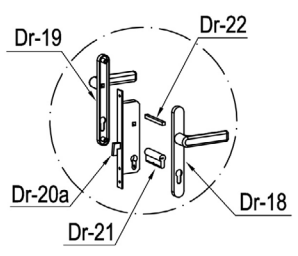
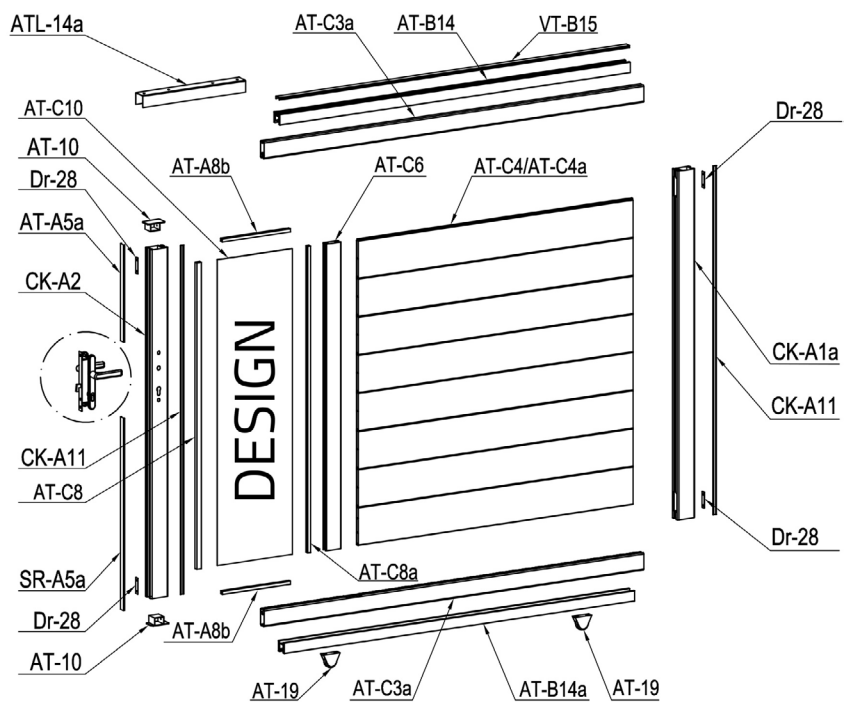

Part B.

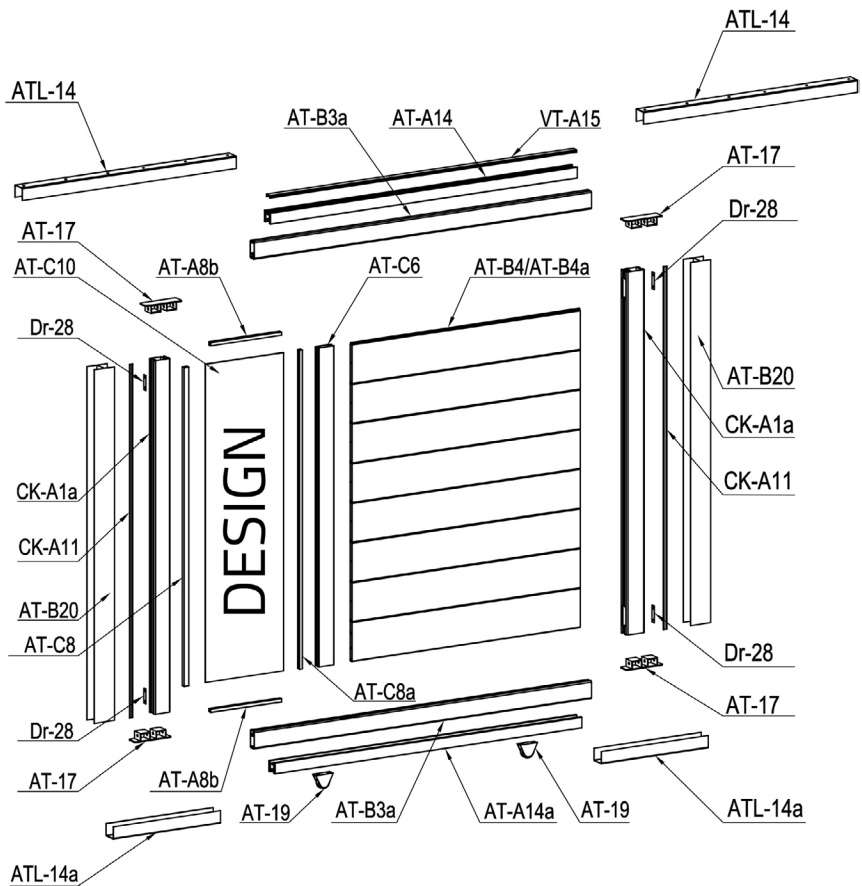



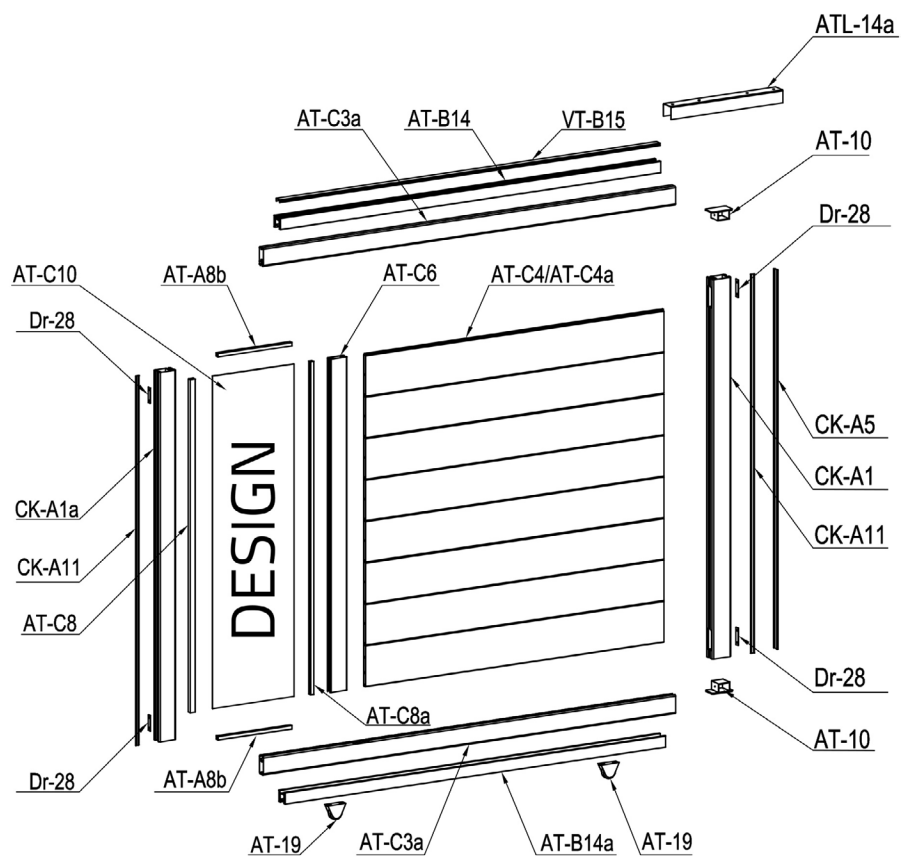

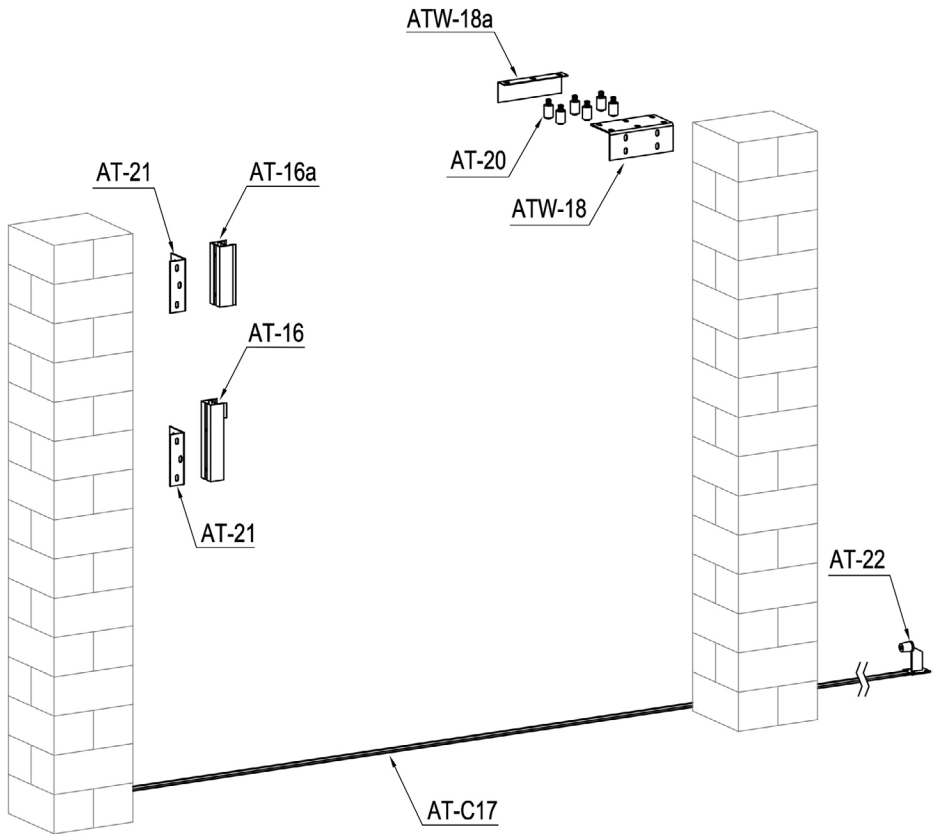







































Part C.







PART LIST

IMAGE	NO.	L.(mm)	QTY	IMAGE	NO.	L.(mm)	QTY
	CK-A1	1418	1		AT-C17	1580	6
	CK-A1a	1418	4		ATW-18		1
	CK-A2	1418	1		ATW-18a		1
	AT-B3a	1471	2		ATL-14	1000	2
	AT-C3a	1721	4		ATL-14a	420	4
	AT-C6	1246	3		AT-19		6
	AT-B4	995	7		AT-20		6
	AT-C4	1245	14		AT-21		2
	AT-B4a	995	1		AT-22		1
	AT-C4a	1245	2		Dr-18		1
	CK-A5	1418	1		Dr-19		1
	AT-A5a	395.5	1		Dr-20a		1
	SR-A5a	782	1		Dr-21		1
	CK-A11	1418	6		Dr-22		1
	AT-C8	1245	3		Dr-25		1
	AT-C8a	1245	3		Dr-25a		2
	AT-A8b	308.5	6		Dr-27		2
	AT-C10	1243	3		Dr-28		12
	AT-B20	1338	2		AT-22J		10
	AT-A14	1338	1		AT-CN30	ST4x10	4
	AT-A14a	1338	1		AT-CN31	M8x60	14
	AT-B14	1588	2		AT-CN32	ST5.5x38	46
	AT-B14a	1588	2		AT-CN33	M8x130	4
	VT-A15	1337	1		AT-CN34	ST4.8x38	40
	VT-B15	1587	2		AT-CN35	ST4.2x19	72
	AT-16	260	1		AT-CN36	M6x20	4
	AT-16a	205	1		AT-CN37	M8x20	12
	AT-17		4		AT-CN38	ST4x25	60
	AT-10		4		AT-CN39	ST4.2x13	12

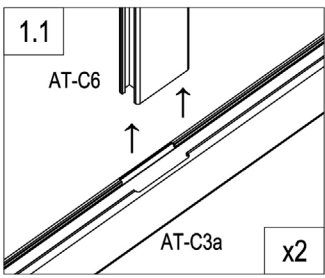
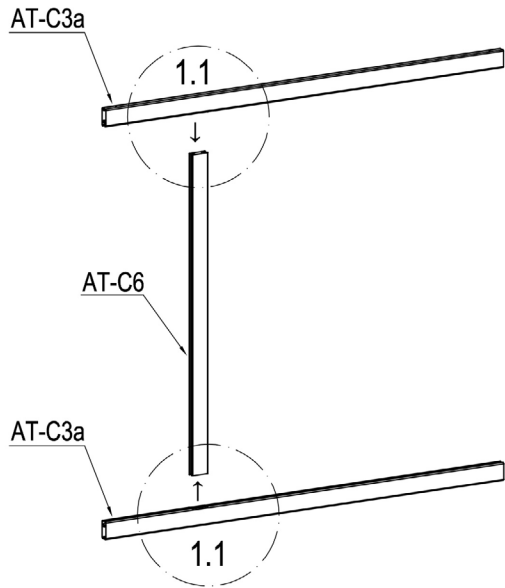
Part A.



	AT-C6	1
	AT-C3a	2

Part A.

EN :you can flip and switch the direction of this plate to personalize your gate

FR: vous pouvez retourner et changer la direction de cette plaque pour personnaliser votre portail

DE: Sie können dieses Schild umdrehen und die Richtung wechseln, um Ihr Tor zu personalisieren.

ES: puedes girar y cambiar la dirección de esta placa para personalizar tu puerta





PT: pode virar e mudar a direção desta placa para personalizar o seu portão

IT: potete capovolgere e cambiare la direzione di questa piastra per personalizzare il vostro cancello

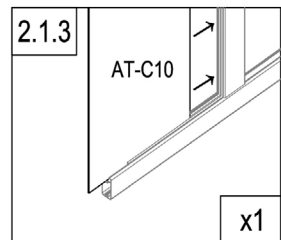
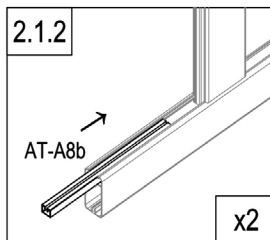
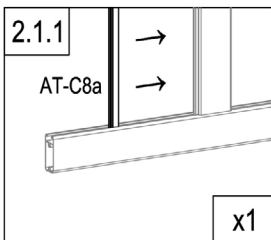
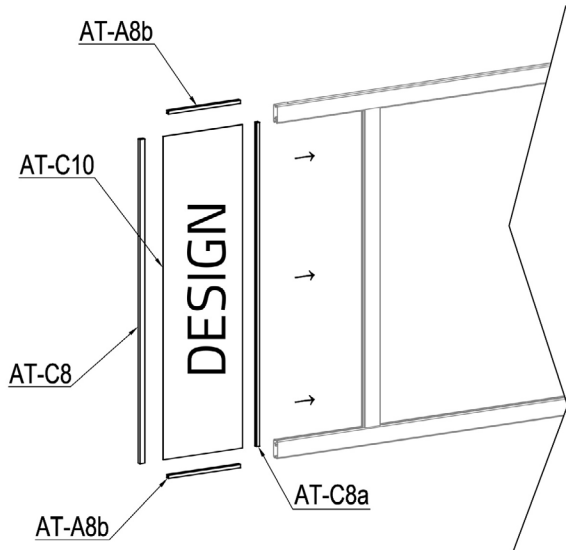
NL: u kunt de richting van deze plaat omdraaien en veranderen om uw poort te verpersoonlijken...

PL: można obrócić i przełączyć kierunek tej płyty, aby spersonalizować bramę.



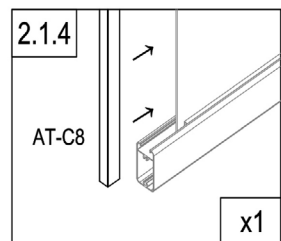

	AT-C8a	1
	AT-A8b	2
	AT-C10	1
	AT-C8	1



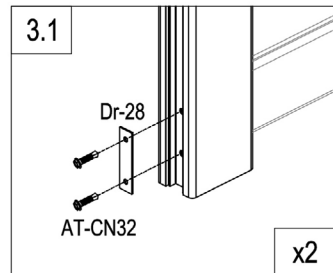
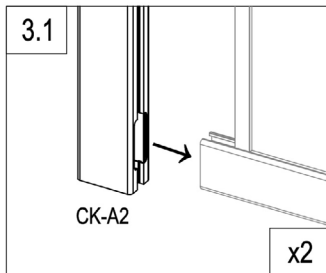
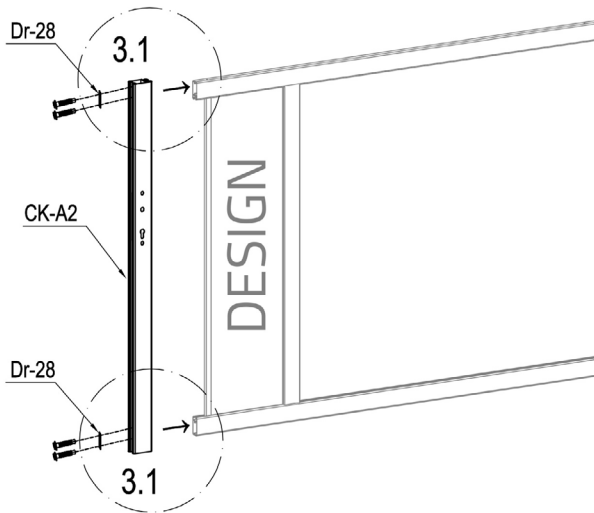

Part A.

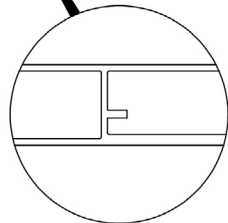
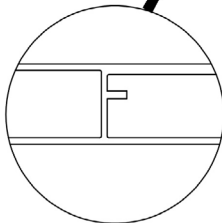
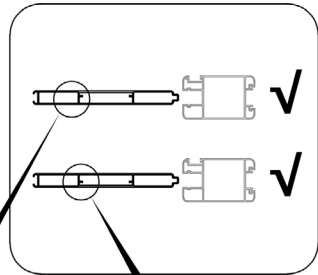
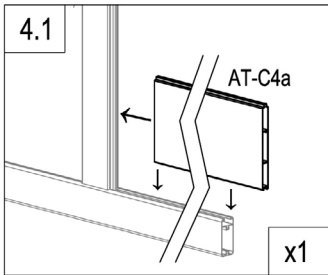
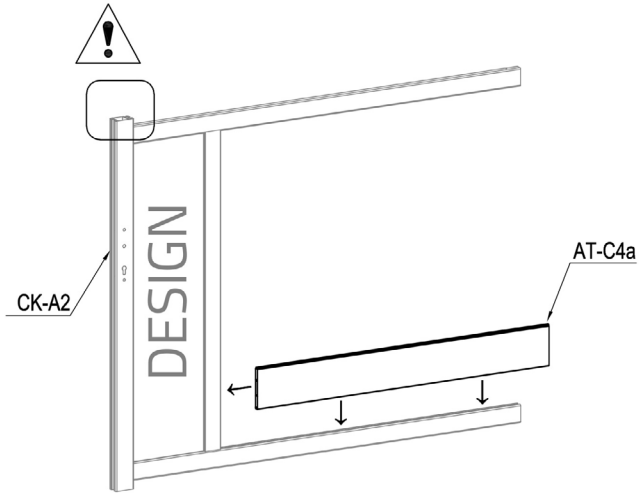

	CK-A2	1
	Dr-28	2
	AT-CN32	4

Part A.



	AT-C4a	1
---	--------	---

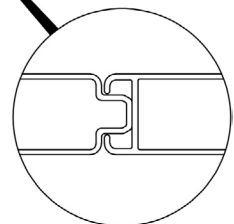
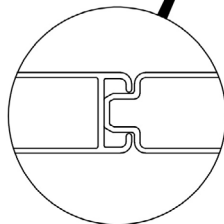
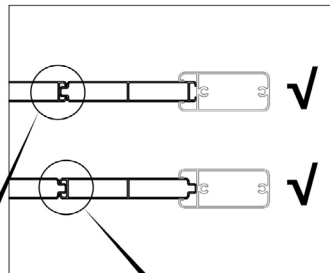
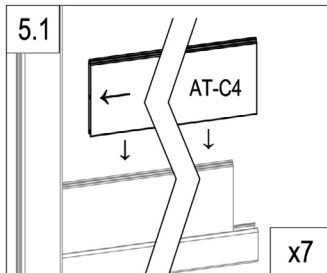
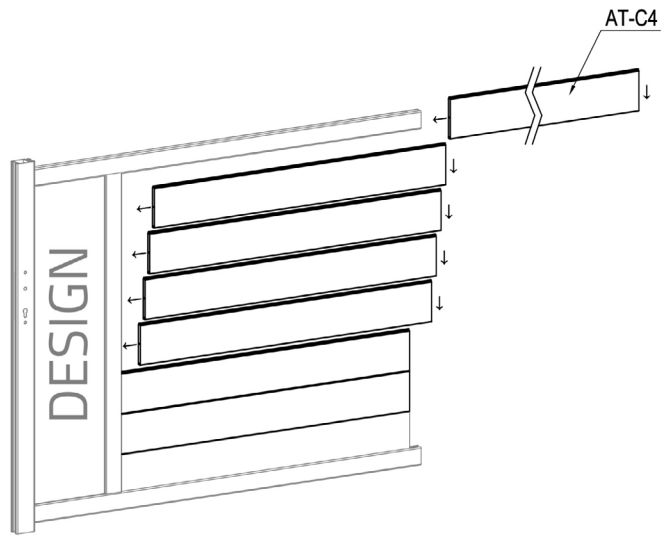

Part A.

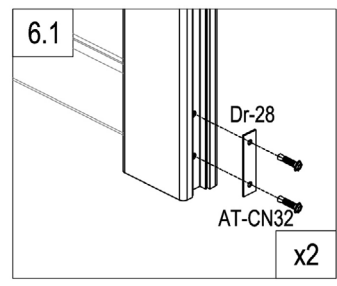
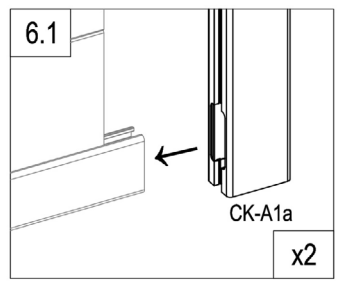
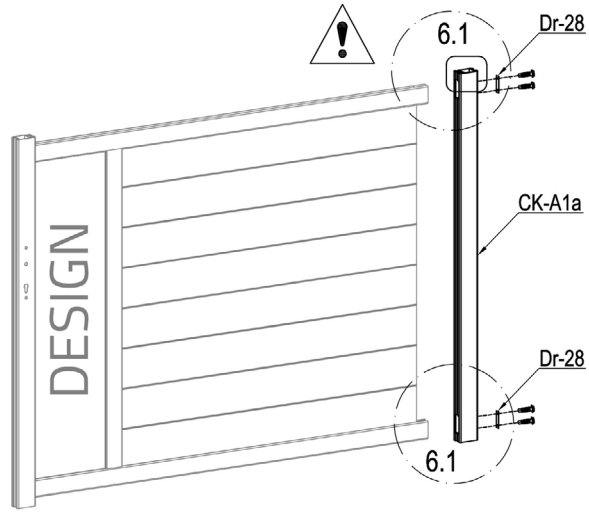

	AT-C4	7
---	-------	---

Part A.



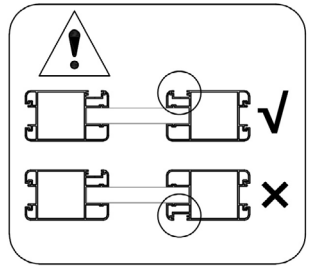

	CK-A1a	1
	Dr-28	2
	AT-CN32	4



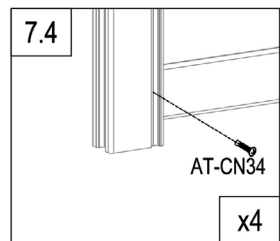
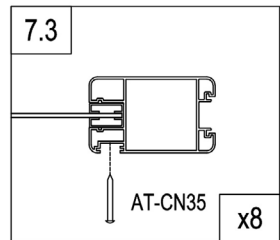
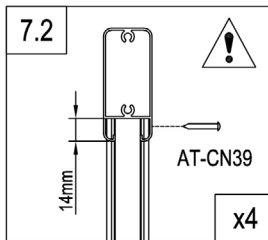
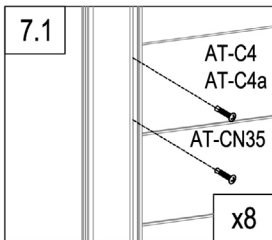
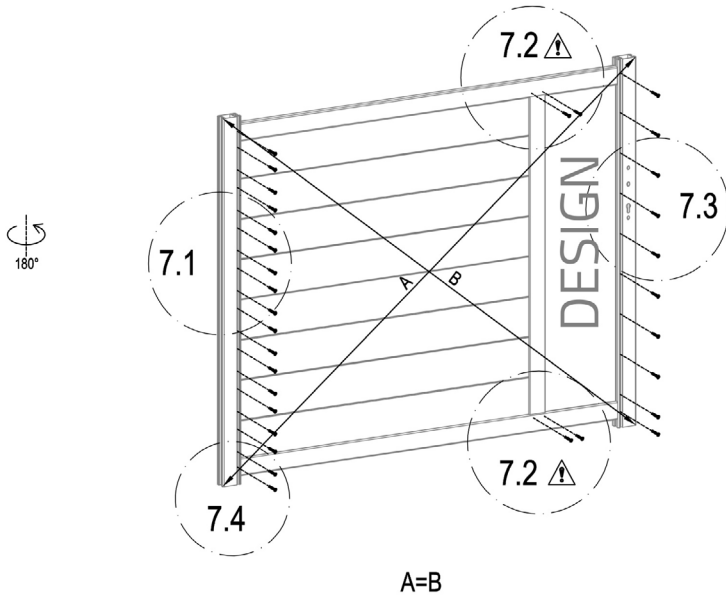

Part A.

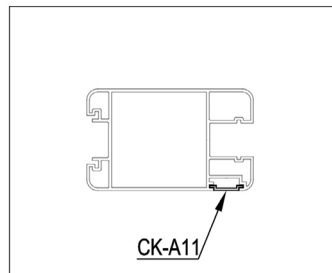
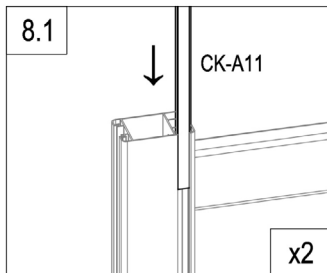
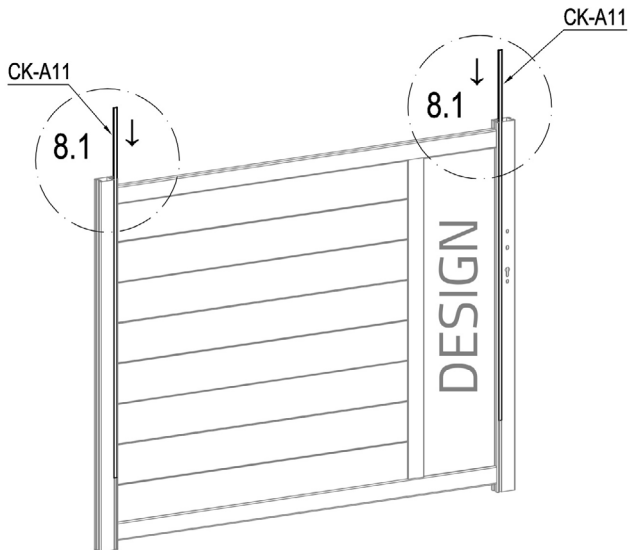

	AT-CN34	4
	AT-CN35	24
	AT-CN39	4

Part A.



	CK-A11	2
---	--------	---

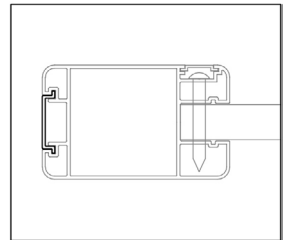
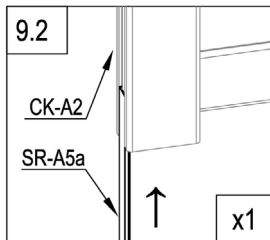
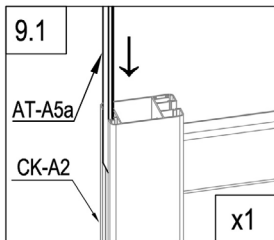
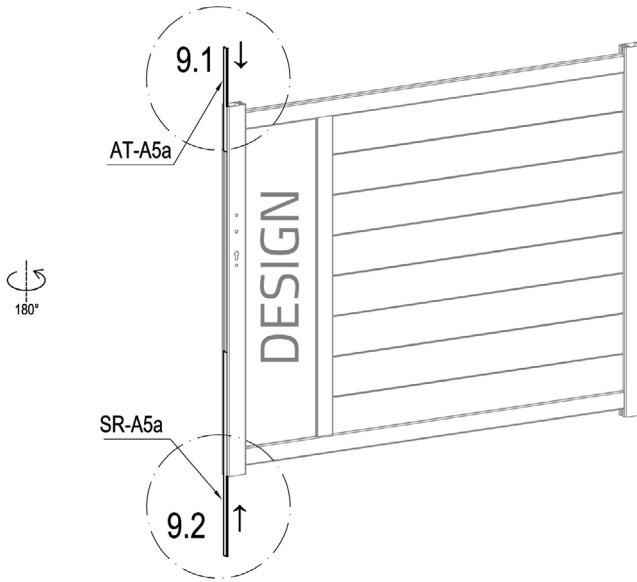

Part A.



	AT-A5a	1
	SR-A5a	1

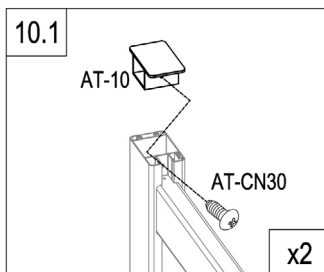
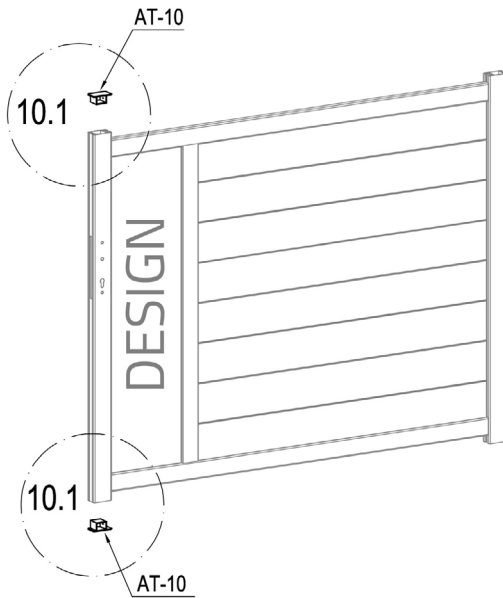

Part A.

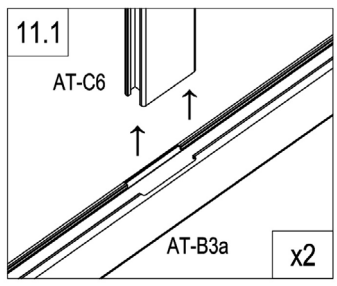
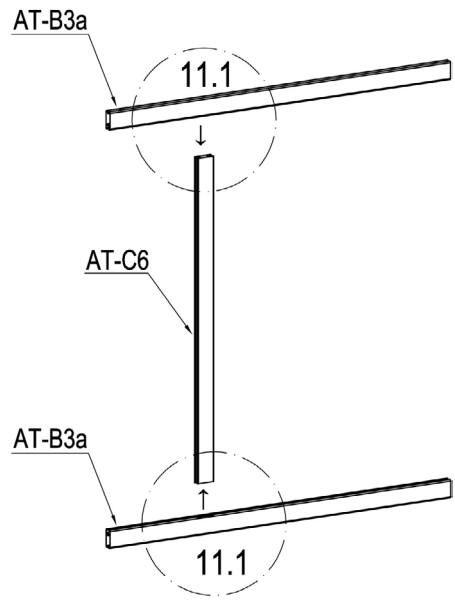

	AT-10	2
	AT-CN30	2

Part B.



	AT-C6	1
	AT-B3a	2

Part B.

EN :you can flip and switch the direction of this plate to personalize your gate

FR: vous pouvez retourner et changer la direction de cette plaque pour personnaliser votre portail

DE: Sie können dieses Schild umdrehen und die Richtung wechseln, um Ihr Tor zu personalisieren.

ES: puedes girar y cambiar la dirección de esta placa para personalizar tu puerta





PT: pode virar e mudar a direção desta placa para personalizar o seu portão

IT: potete capovolgere e cambiare la direzione di questa piastra per personalizzare il vostro cancello

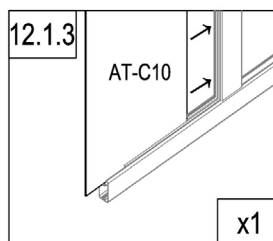
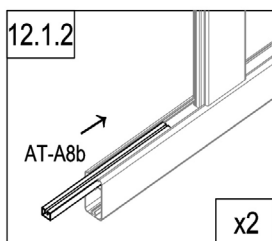
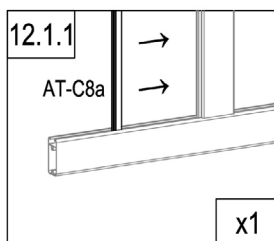
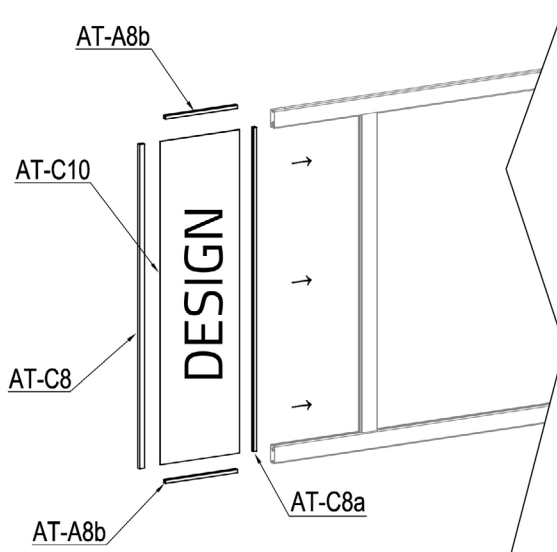
NL: u kunt de richting van deze plaat omdraaien en veranderen om uw poort te verpersoonlijken...

PL: można obrócić i przełączyć kierunek tej płyty, aby spersonalizować bramę.



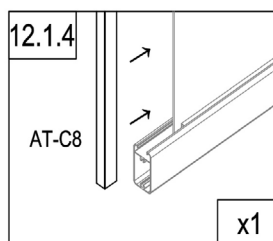

	AT-C8a	1
	AT-A8b	2
	AT-C10	1
	AT-C8	1

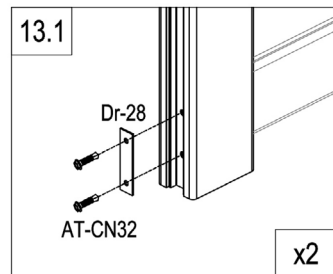
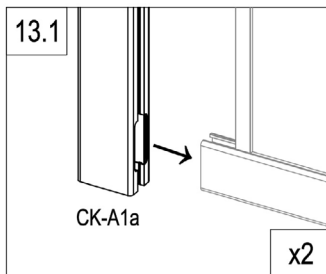
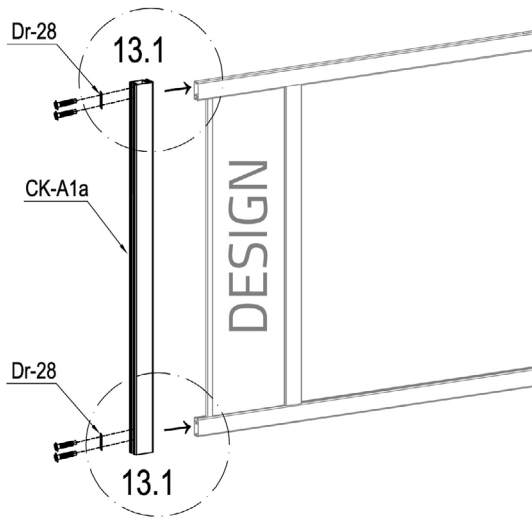

Part B.



	CK-A1a	1
	Dr-28	2
	AT-CN32	4

Part B.

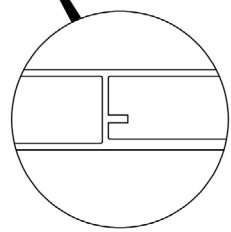
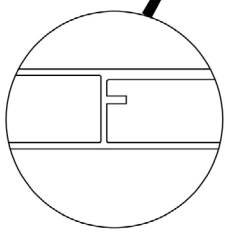
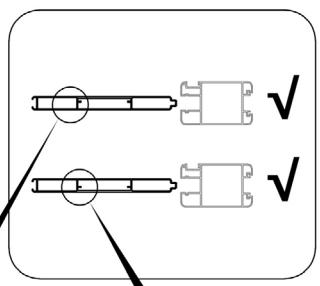
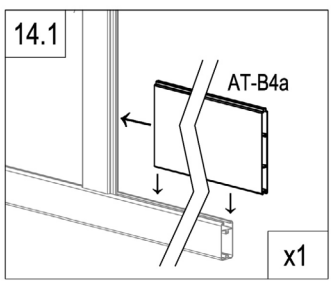
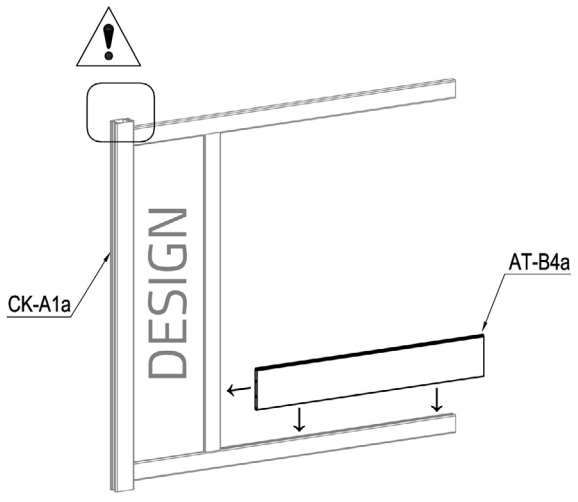

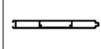
	AT-B4a	1
---	--------	---

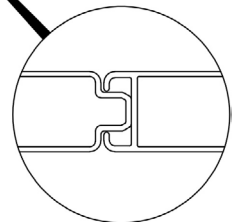
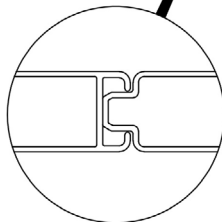
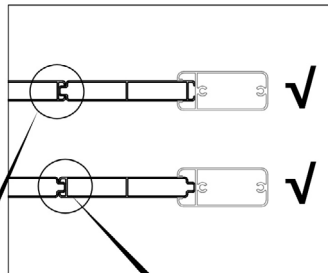
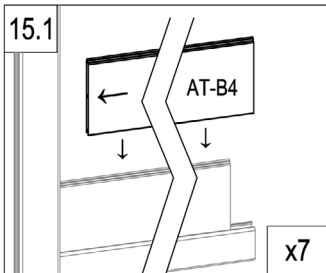
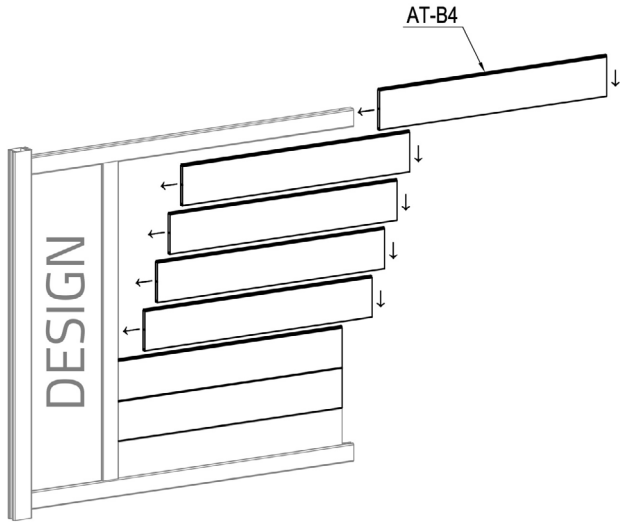

Part B.

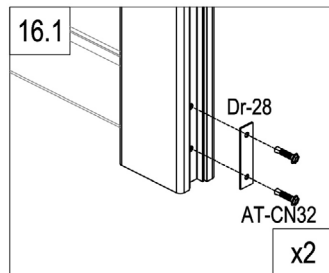
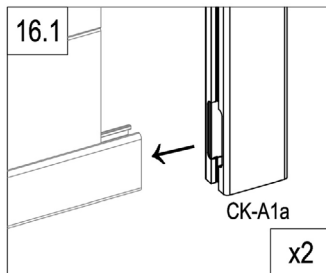
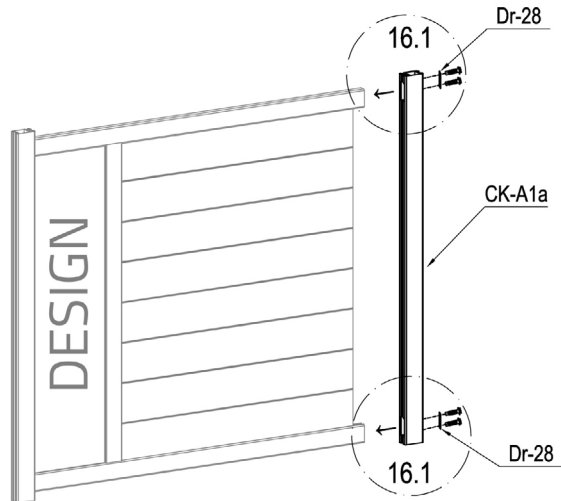

	AT-B4	7
---	-------	---

Part B.



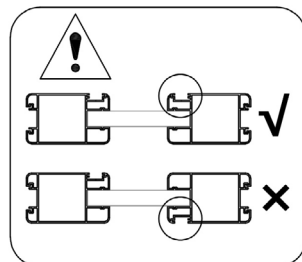

	CK-A1a	1
	Dr-28	2
	AT-CN32	4



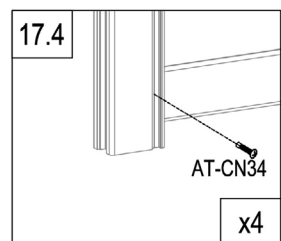
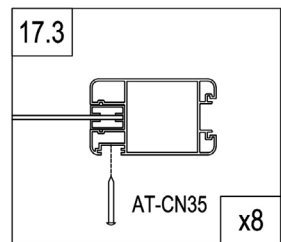
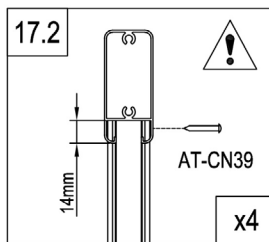
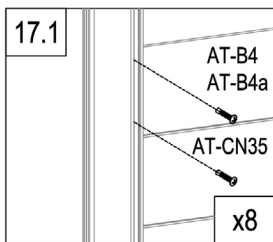
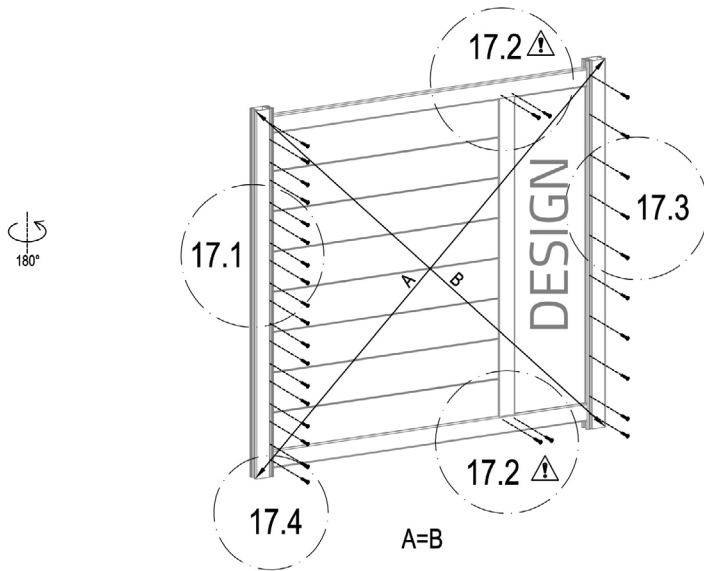

Part B.



	AT-CN34	4
	AT-CN35	24
	AT-CN39	4

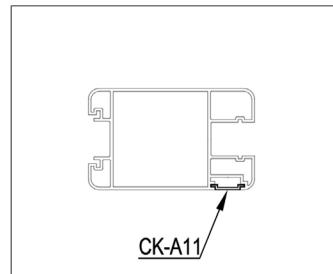
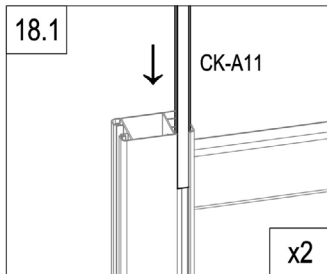
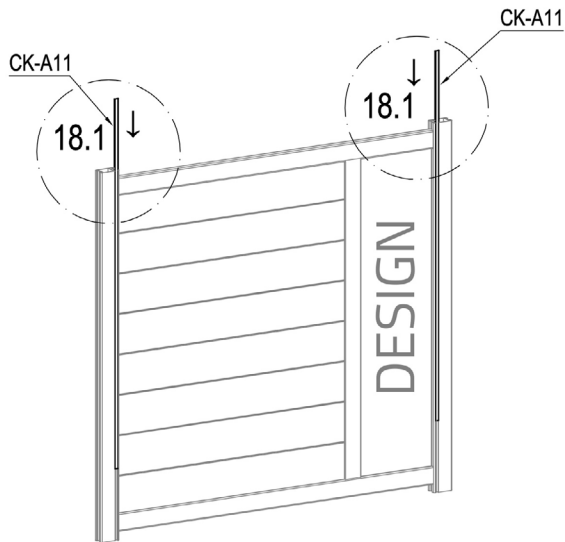

Part B.

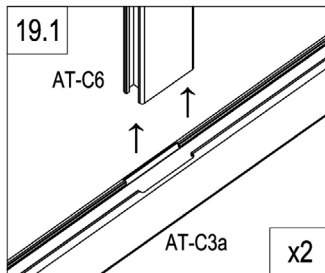
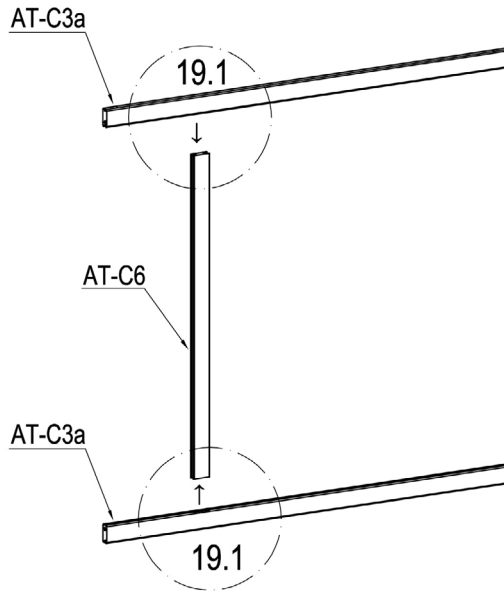

	CK-A11	2
---	--------	---

Part C.



	AT-C6	1
	AT-C3a	2

Part C.

EN :you can flip and switch the direction of this plate to personalize your gate

FR: vous pouvez retourner et changer la direction de cette plaque pour personnaliser votre portail

DE: Sie können dieses Schild umdrehen und die Richtung wechseln, um Ihr Tor zu personalisieren.

ES: puedes girar y cambiar la dirección de esta placa para personalizar tu puerta





PT: pode virar e mudar a direção desta placa para personalizar o seu portão

IT: potete capovolgere e cambiare la direzione di questa piastra per personalizzare il vostro cancello

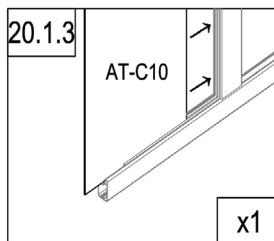
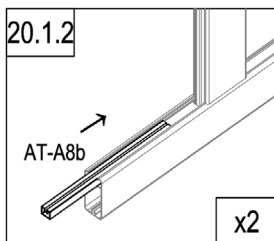
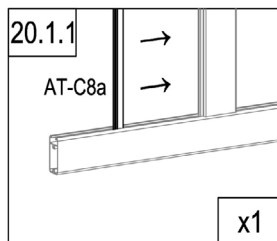
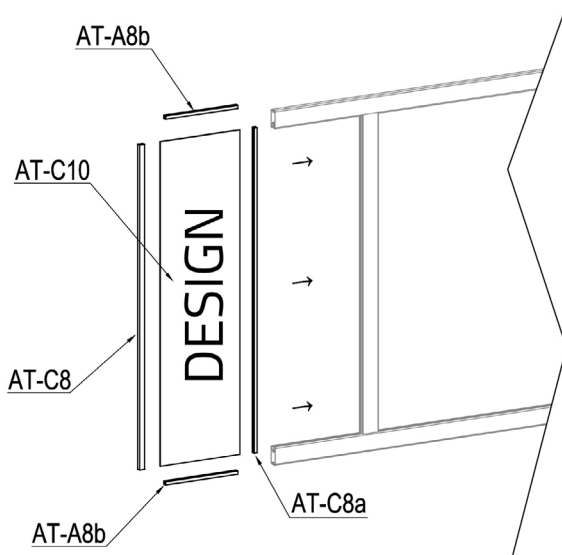
NL: u kunt de richting van deze plaat omdraaien en veranderen om uw poort te verspersonlijken...

PL: można obrócić i przełączyć kierunek tej płyty, aby personalizować bramę.



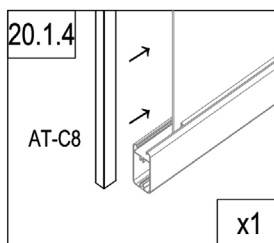

	AT-C8a	1
	AT-A8b	2
	AT-C10	1
	AT-C8	1



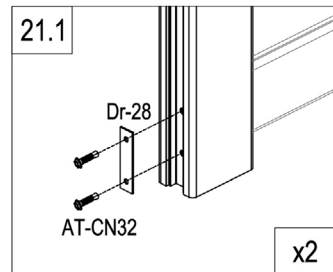
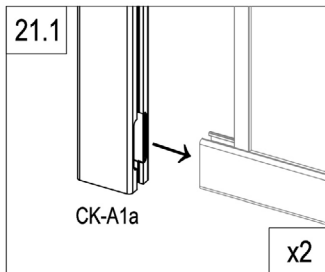
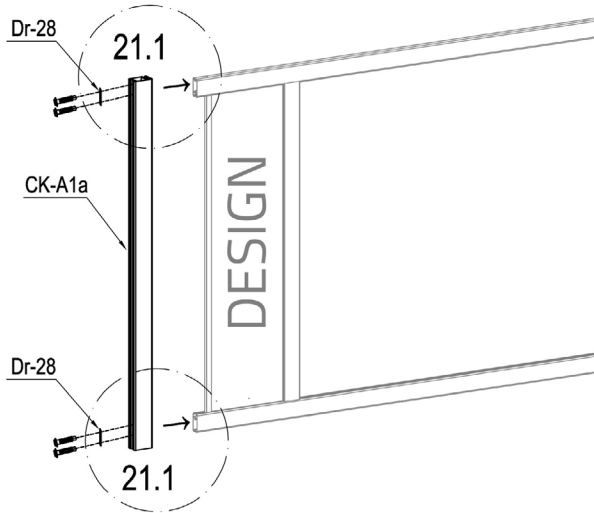

Part C.

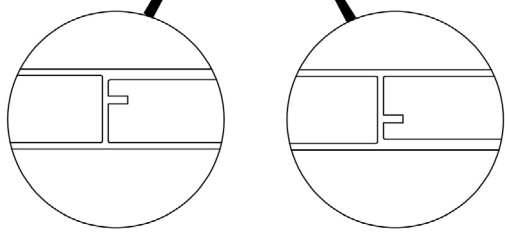
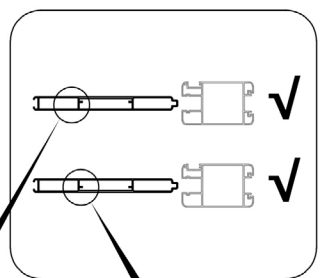
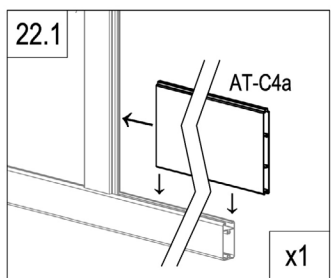
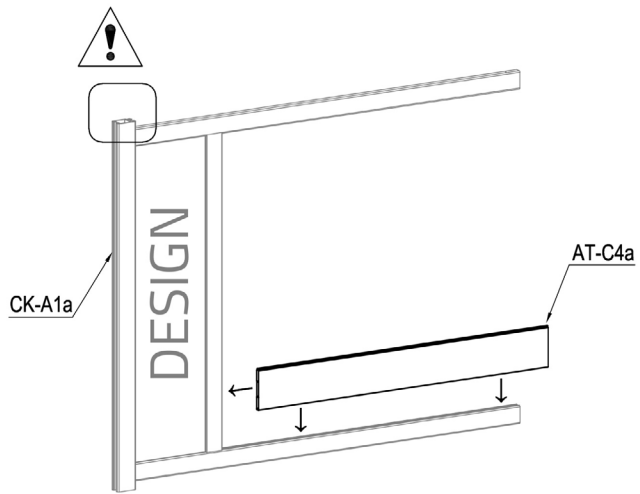

	CK-A1a	1
	Dr-28	2
	AT-CN32	4

Part C.



	AT-C4a	1
---	--------	---

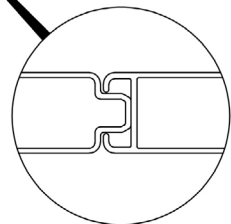
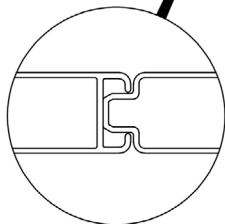
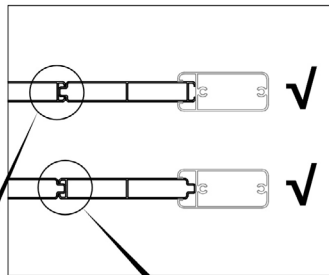
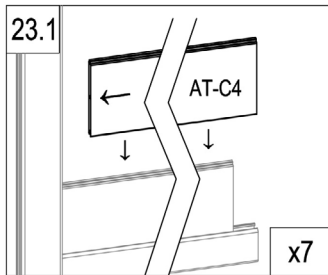
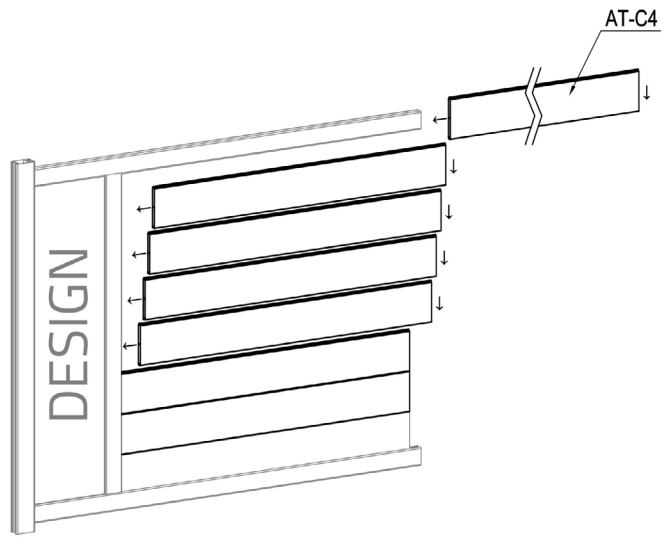

Part C.

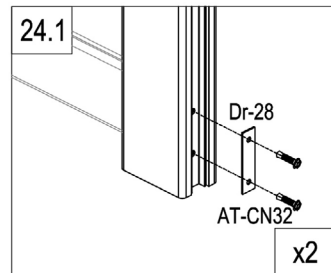
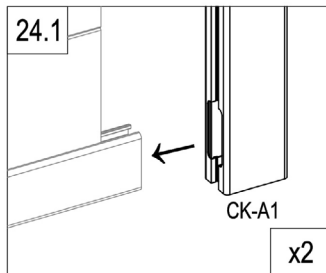
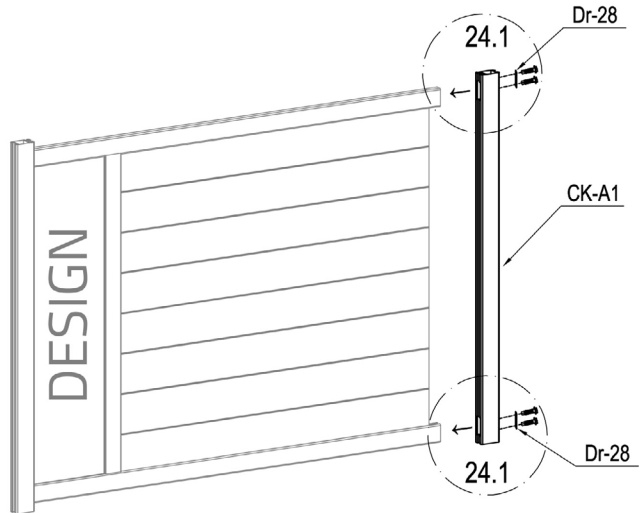

	AT-C4	7
---	-------	---

Part C.



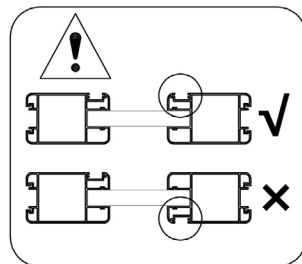

	CK-A1	1
	Dr-28	2
	AT-CN32	4



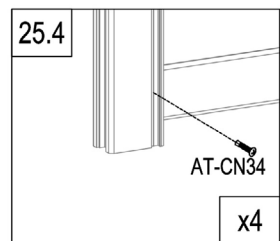
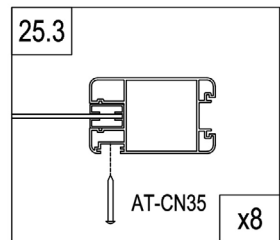
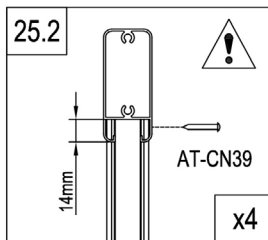
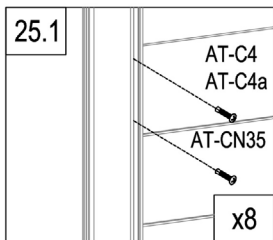
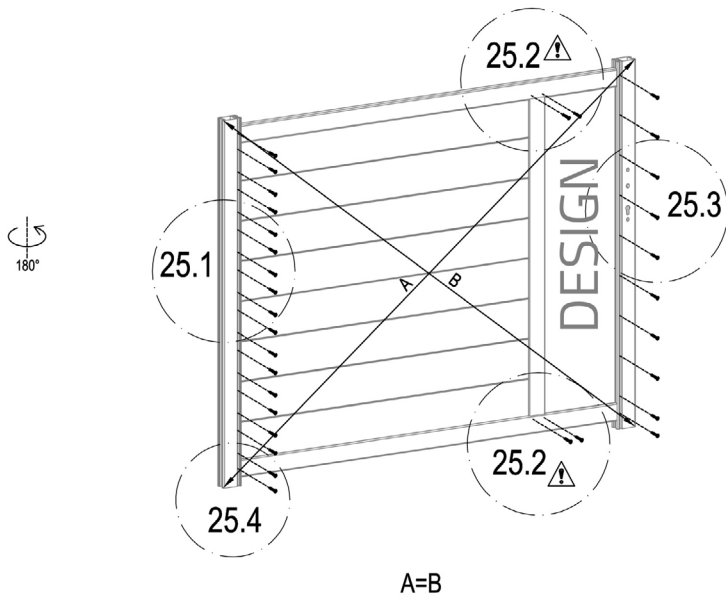

Part C.

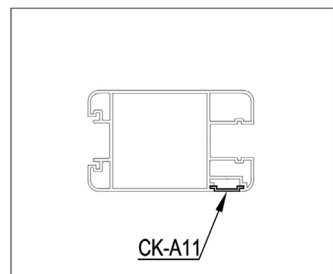
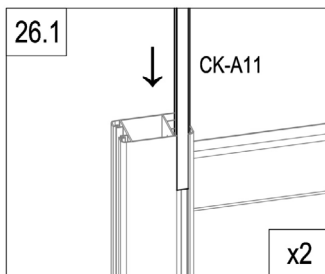
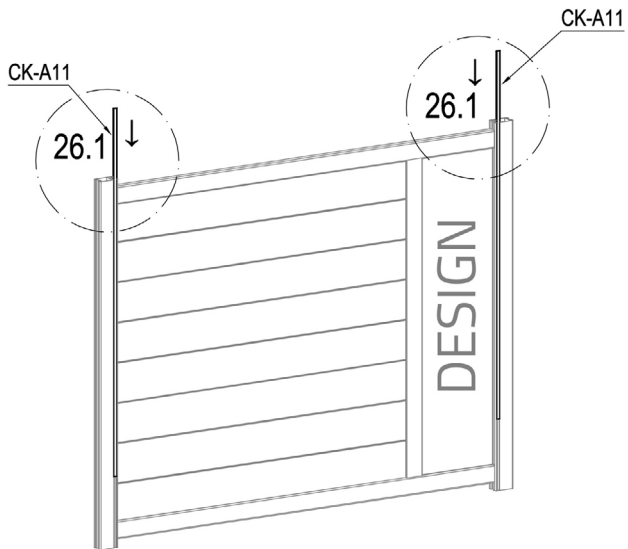

	AT-CN34	4
	AT-CN35	24
	AT-CN39	4

Part C.



	CK-A11	2
---	--------	---

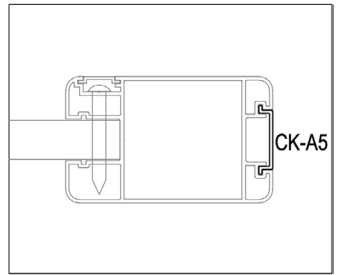
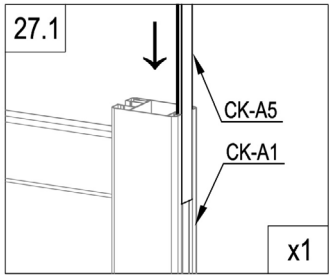
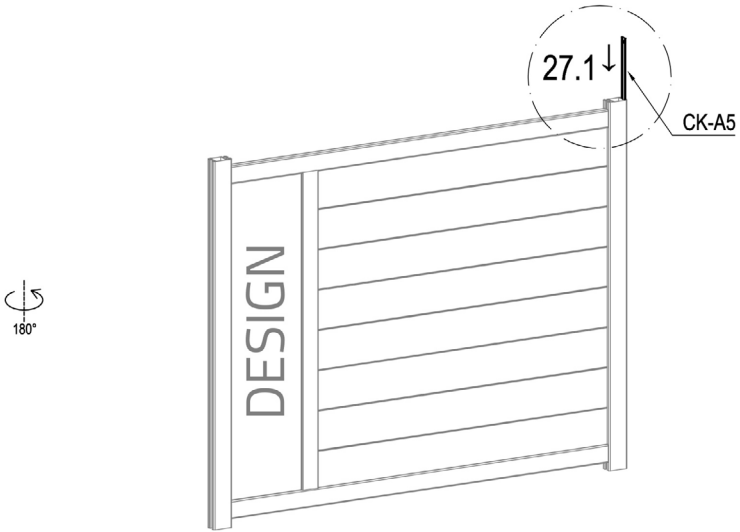

Part C.

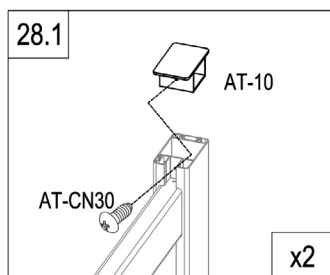
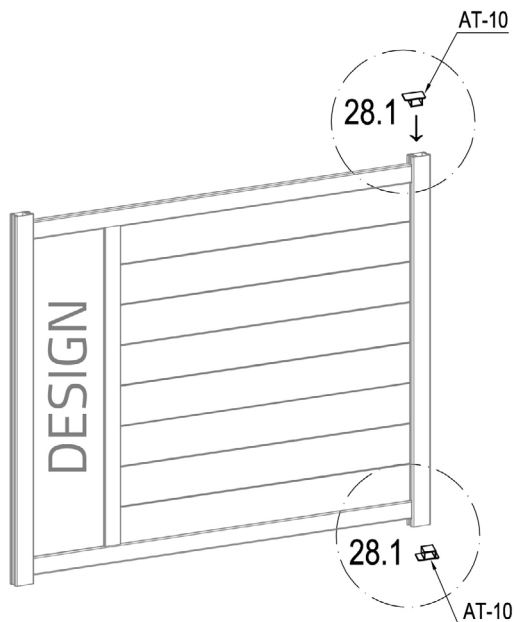

]	CK-A5	1
---	-------	---

Part C.



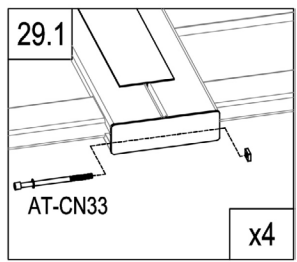
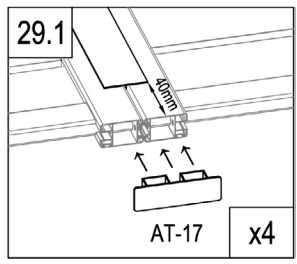
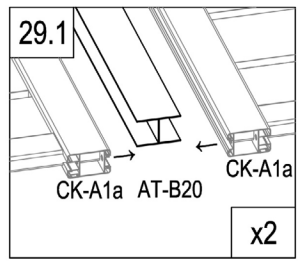
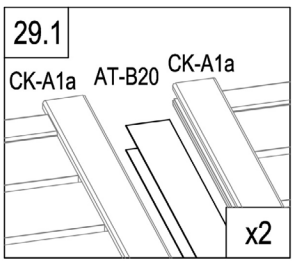
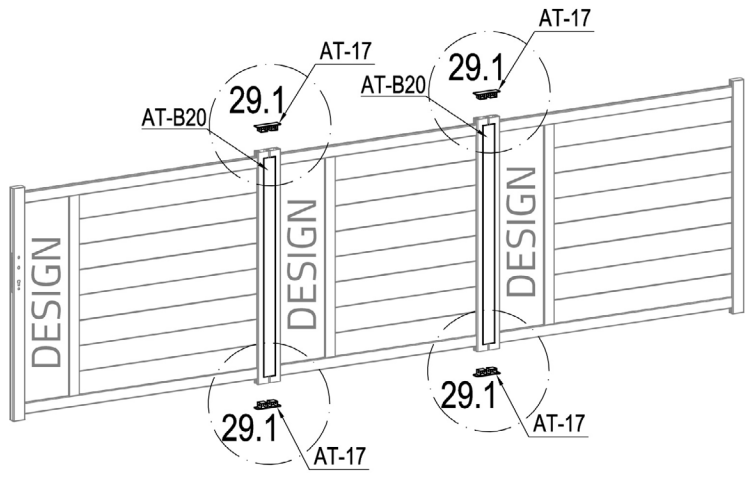

	AT-10	2
	AT-CN30	2

CASANOVO

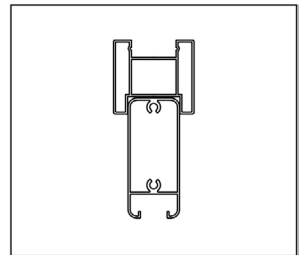
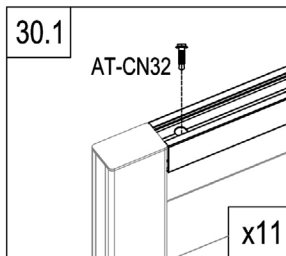
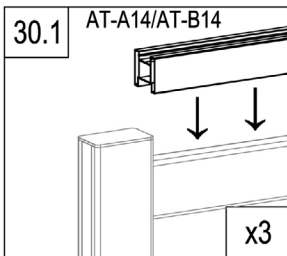
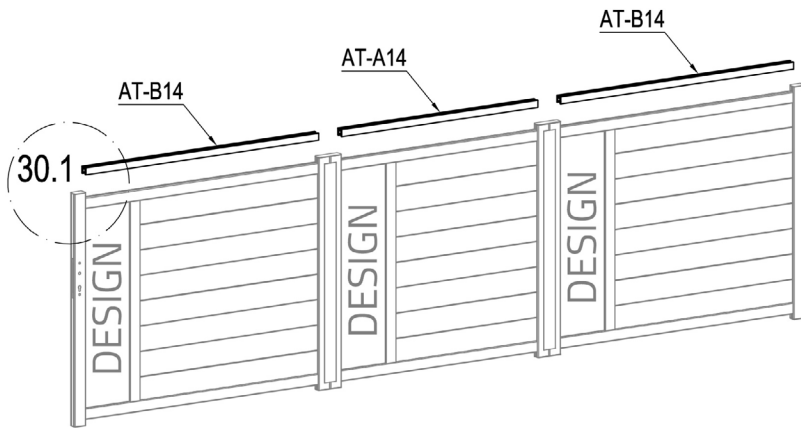

	AT-B20	2
	AT-17	4
	AT-CN33	4



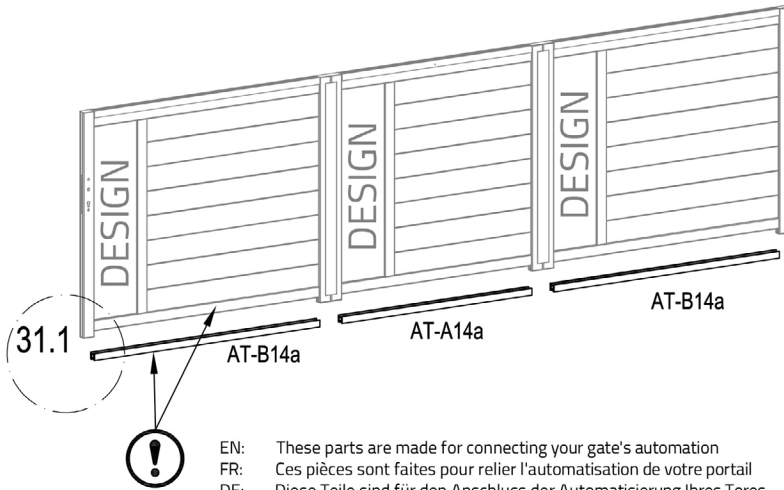

	AT-B14	2
	AT-A14	1
	AT-CN32	11

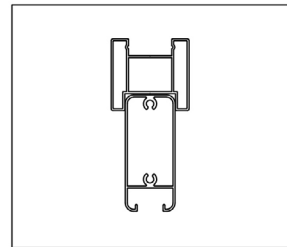
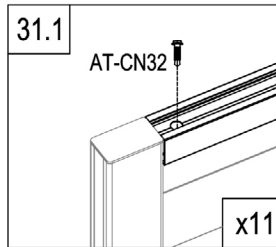
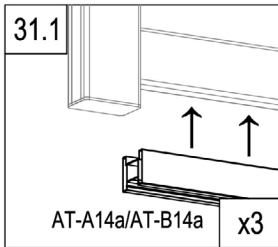

EN: These parts are made for connecting your gate's automation
 FR: Ces pièces sont faites pour relier l'automatisation de votre portail
 DE: Diese Teile sind für den Anschluss der Automatisierung Ihres Tores vorgesehen
 ES: Estas piezas están hechas para conectar la automatización de su puerta
 PT: Estas peças são feitas para ligar a automatização do seu portão
 IT: Queste parti sono realizzate per collegare l'automazione del vostro cancello
 NL: Deze onderdelen zijn gemaakt voor het aansluiten van de automatisering van uw poort.
 PL: Te części są wykonane do podłączenia automatyki bramy.



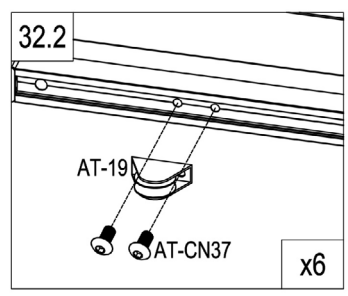
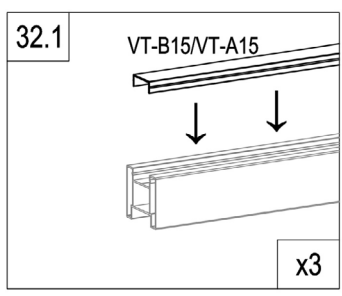
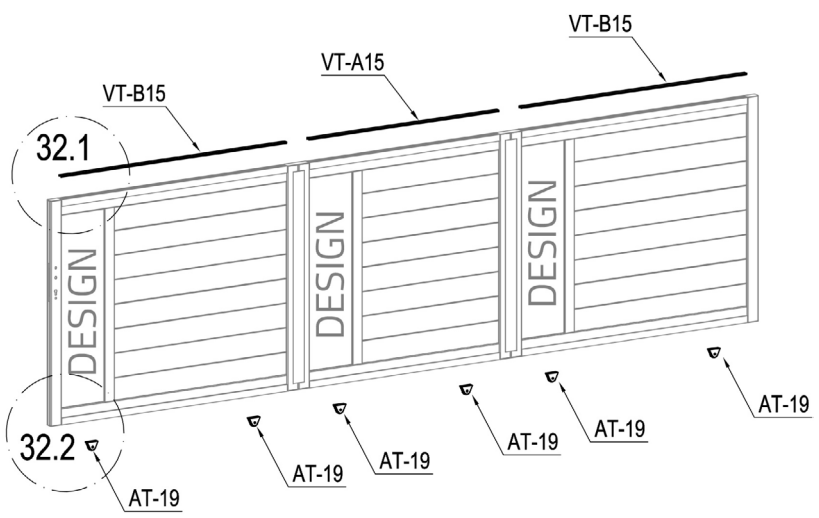

	AT-A14a	2
	AT-B14a	1
	AT-CN32	11

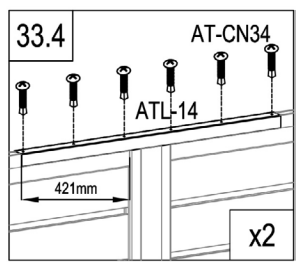
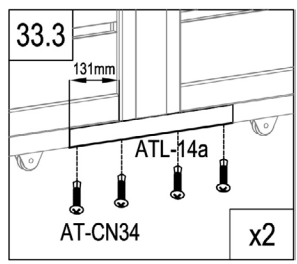
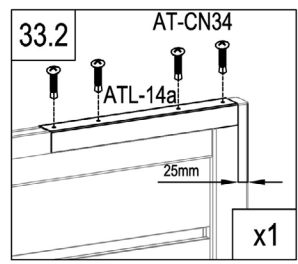
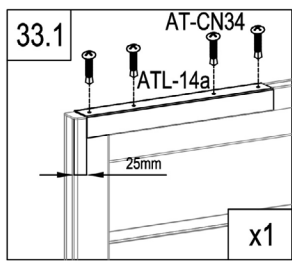
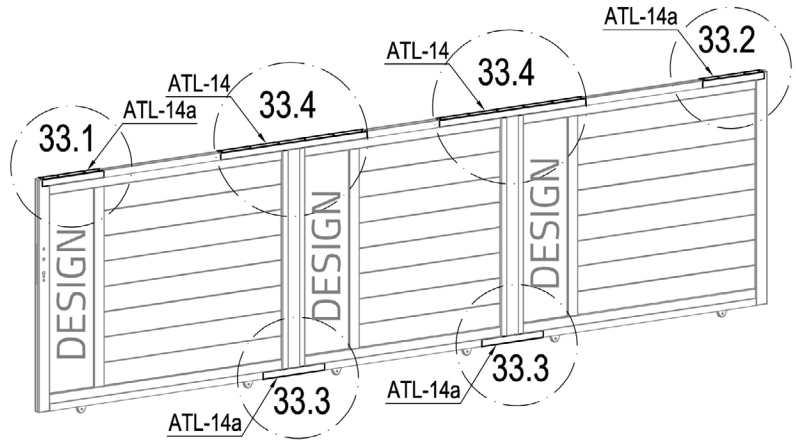

┌	VT-A15	1
	VT-B15	2
└	AT-19	6
●	AT-CN37	12



	ATL-14	2
	ATL-14a	4
	AT-CN34	28

Ext.

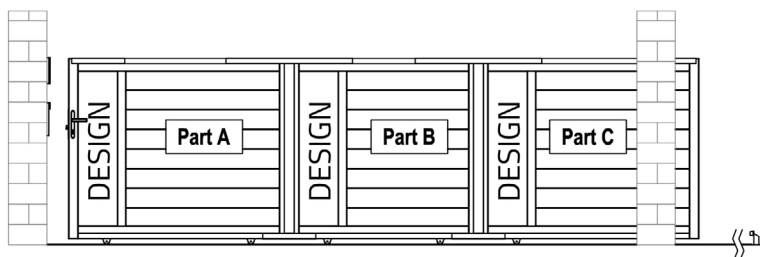

Int.

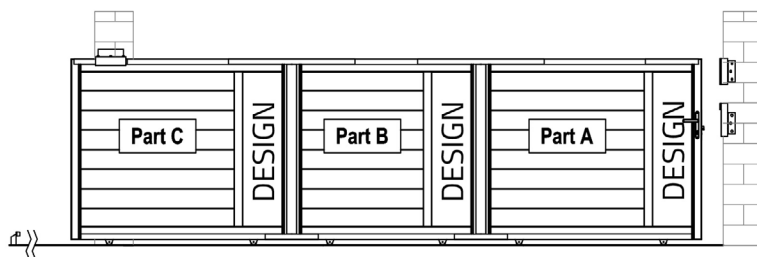

Ext.

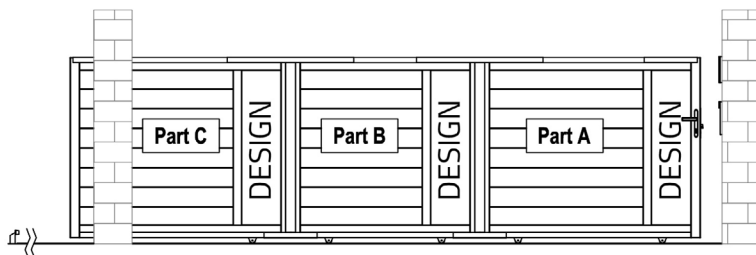

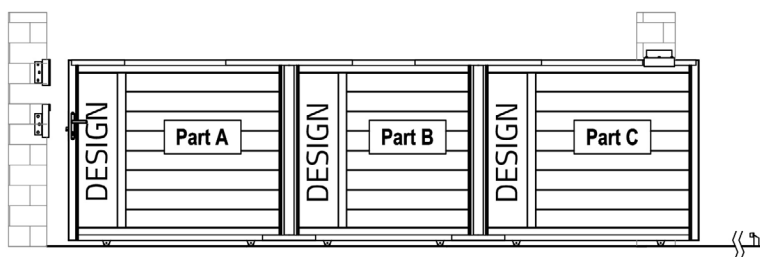

Int.

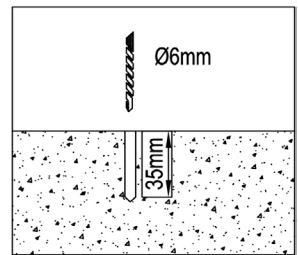
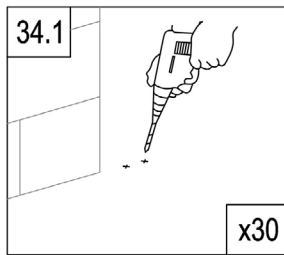
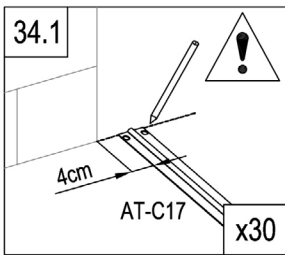
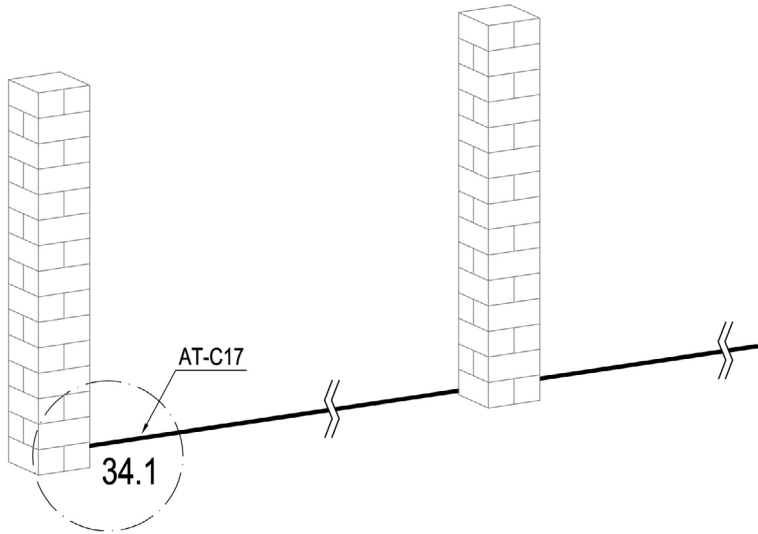

L



	AT-C17	6
	AT-CN38	60

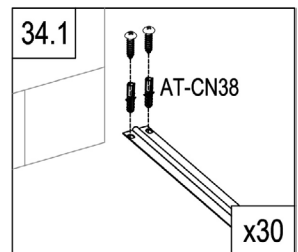

L

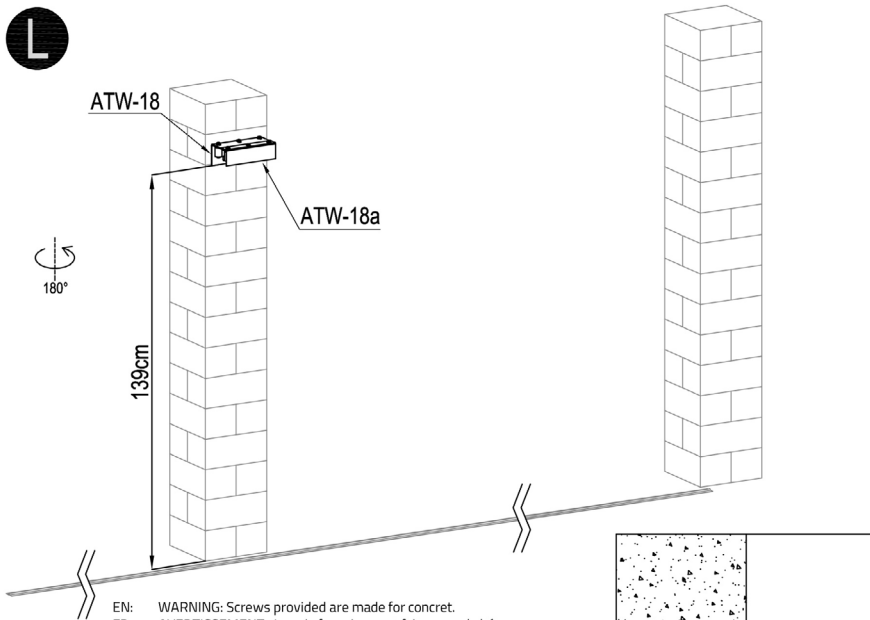

EN: WARNING: Screws provided are made for concret.
 FR: AVERTISSEMENT : Les vis fournies sont faites pour le béton.
 DE: WARNUNG: Die mitgelieferten Schrauben sind für Beton ausgelegt.
 ES: ADVERTENCIA: Los tornillos suministrados están hechos para el hormigón.
 IT: ATTENZIONE: Le viti fornite sono fatte per il calcestruzzo.
 NL: WAARSCHUWING: De bijgeleverde schroeven zijn gemaakt voor beton.
 PL: OSTRZEŻENIE: Dostarczone śruby są przeznaczone do betonu.
 PT: AVISO: Os parafusos fornecidos são feitos para betão.

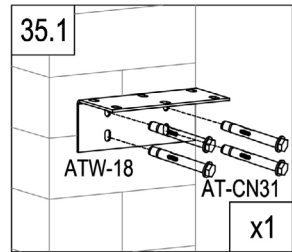
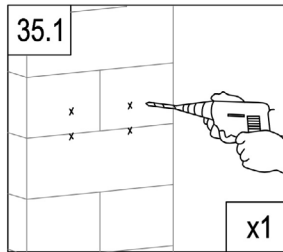
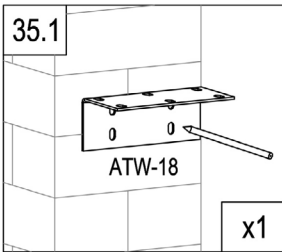
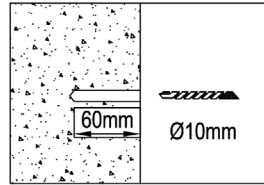

	ATW-18	1
	ATW-18a	1
	AT-20	6
	AT-CN31	4

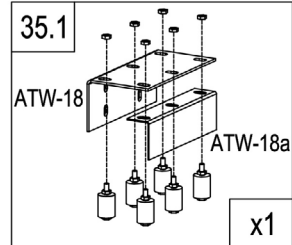
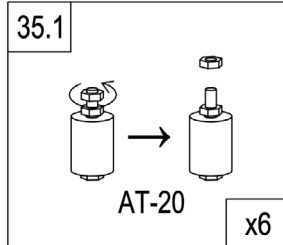

L

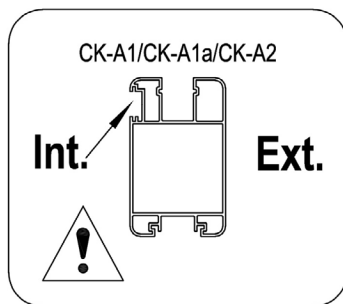
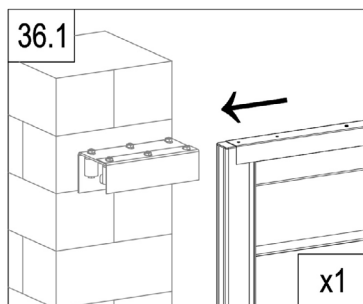
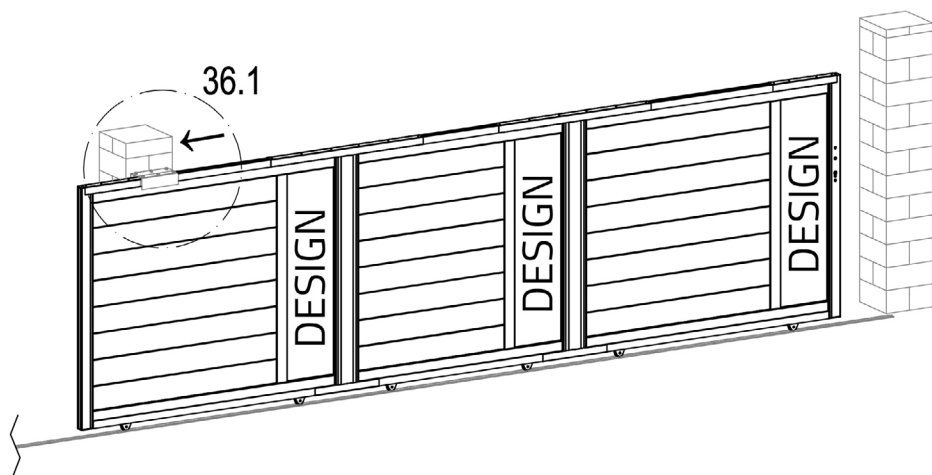

L

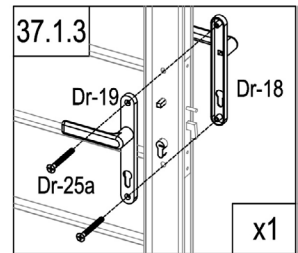
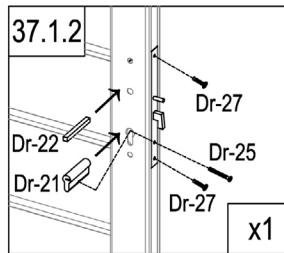
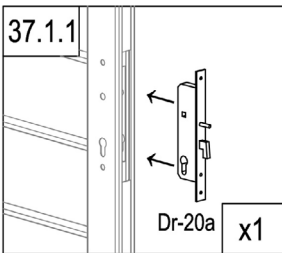
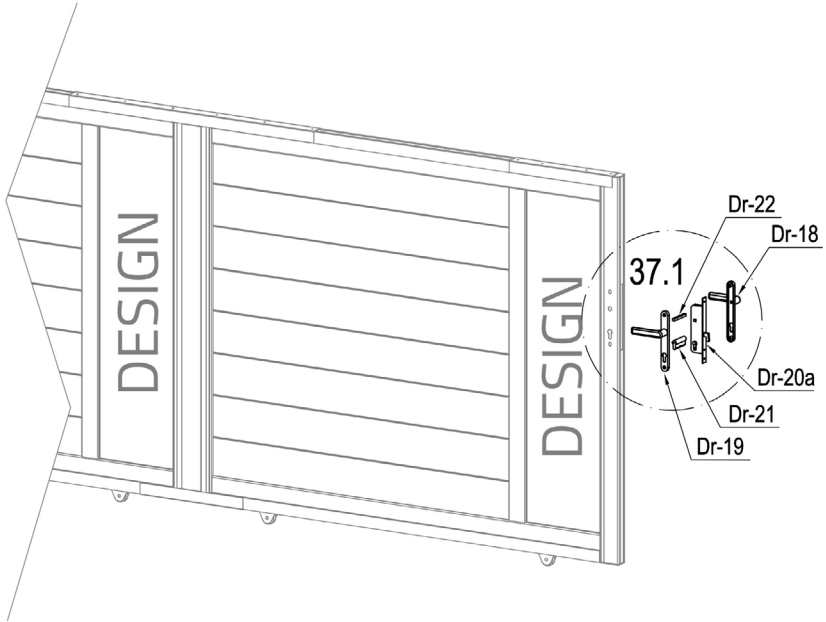

	Dr-20a	1
	Dr-21	1
	Dr-22	1
	Dr-25	1

	Dr-18	1
	Dr-19	1
	Dr-25a	2
	Dr-27	2



EN: WARNING: Screws provided are made for concret.
 FR: AVERTISSEMENT : Les vis fournies sont faites pour le béton.
 DE: WARNUNG: Die mitgelieferten Schrauben sind für Beton ausgelegt.
 ES: ADVERTENCIA: Los tornillos suministrados están hechos para el hormigón.
 IT: ATTENZIONE: Le viti fornite sono fatte per il calcestruzzo.
 NL: WAARSCHUWING: De bijgeleverde schroeven zijn gemaakt voor beton.
 PL: OSTRZEŻENIE: Dostarczone śruby są przeznaczone do betonu.
 PT: AVISO: Os parafusos fornecidos são feitos para betão.

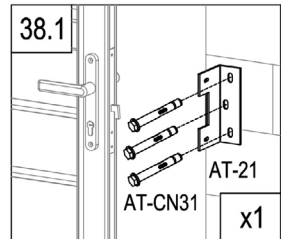
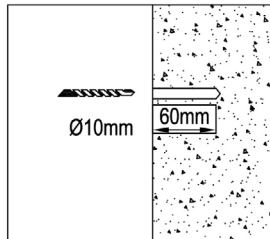
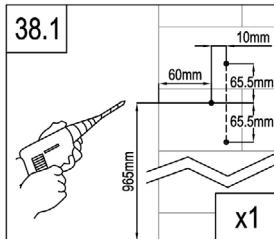
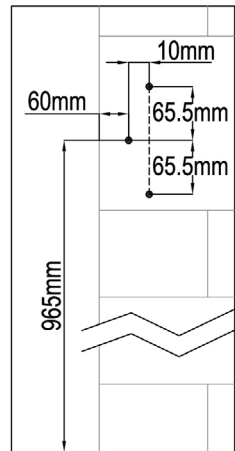
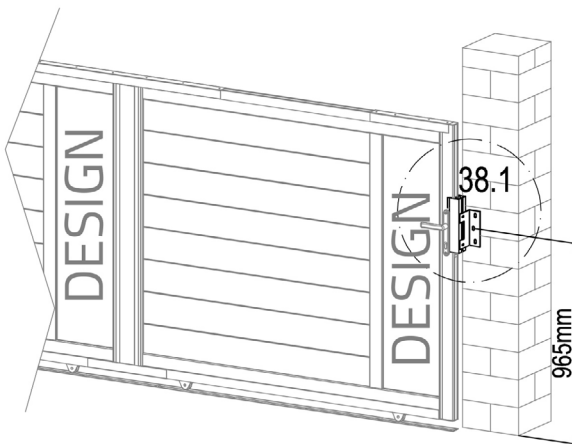

	AT-16	1
	AT-21	1
	AT-CN36	2
	AT-CN31	3
	AT-22J	3

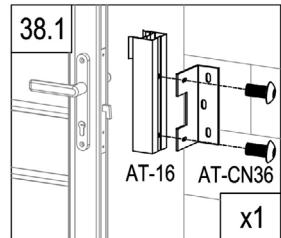
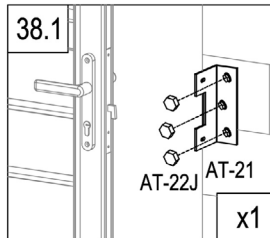

L

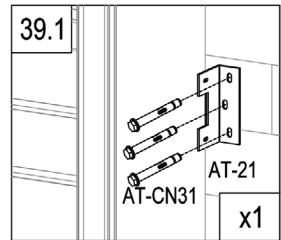
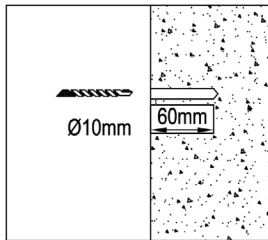
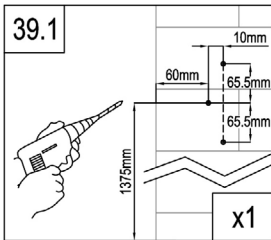
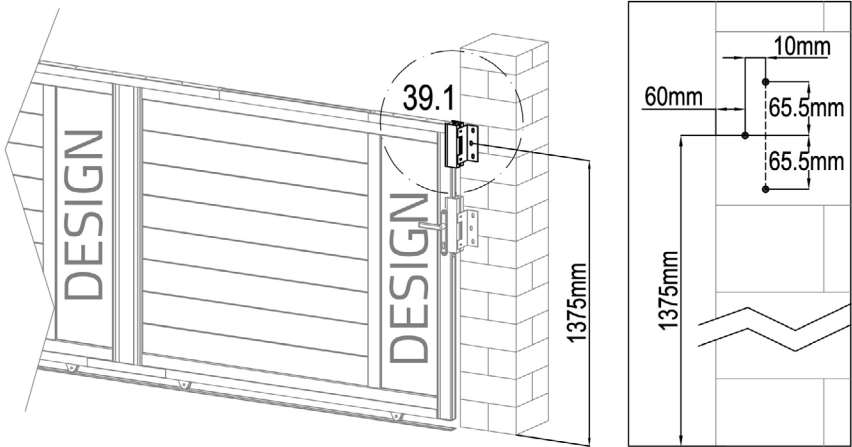

	AT-16a	1
	AT-21	1
	AT-CN36	2
	AT-CN31	3
	AT-22J	3

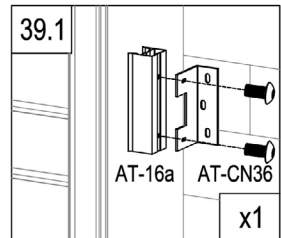
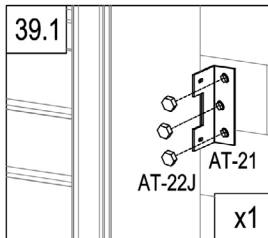

L

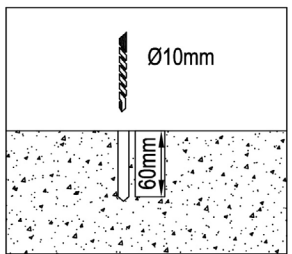
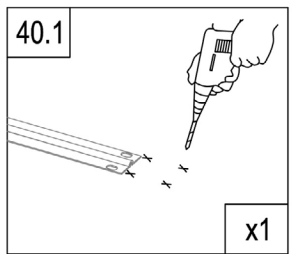
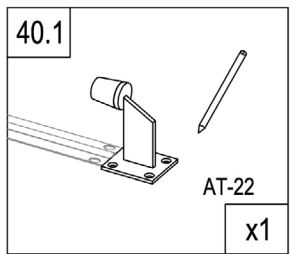
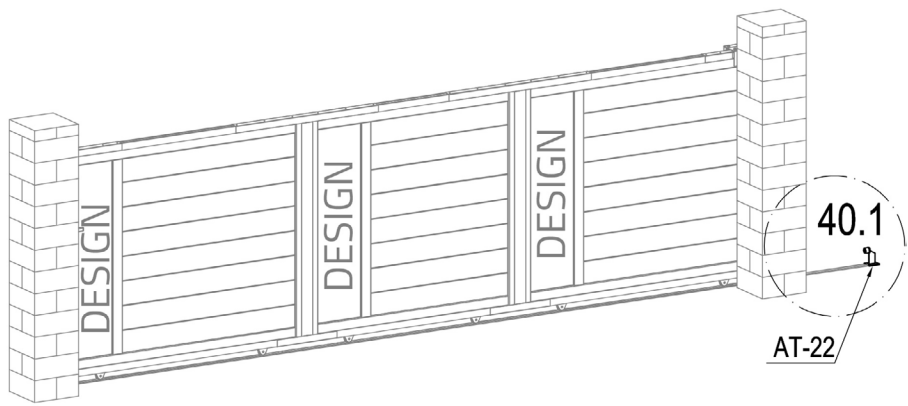

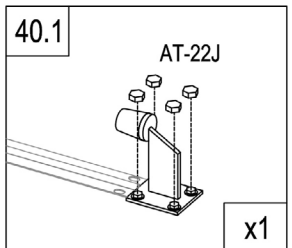
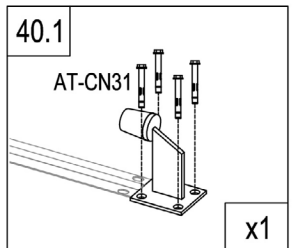

	AT-22	1
	AT-CN31	4
	AT-22J	4

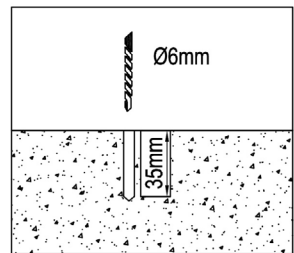
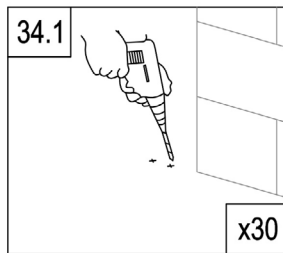
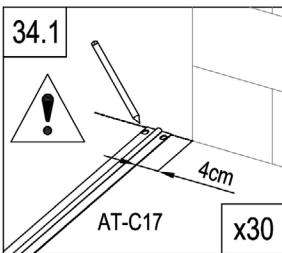
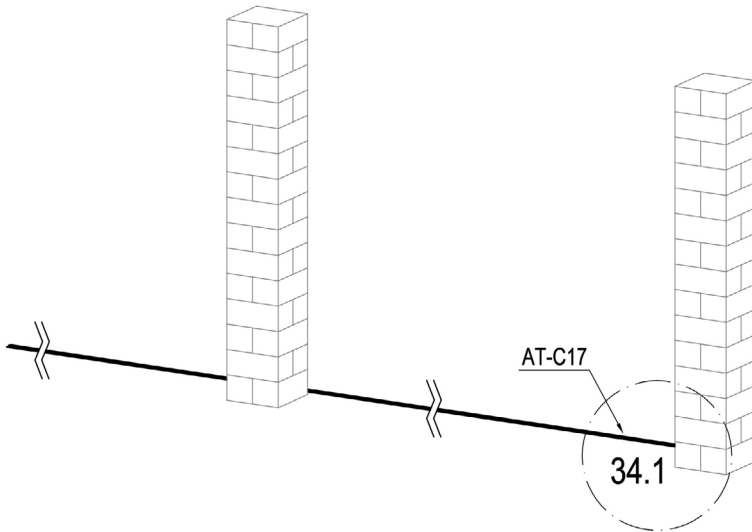

R



	AT-C17	6
	AT-CN38	60

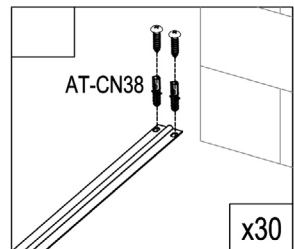

R

180°

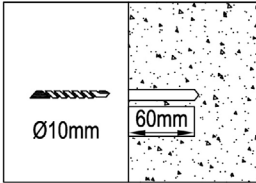
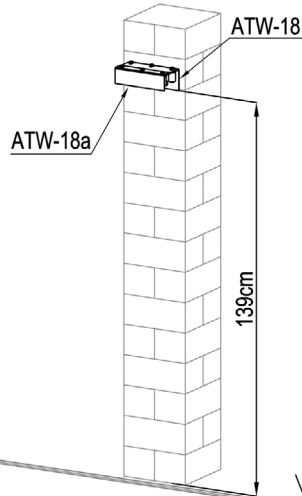

EN: WARNING: Screws provided are made for concret.
 FR: AVERTISSEMENT : Les vis fournies sont faites pour le béton.
 DE: WARNUNG: Die mitgelieferten Schrauben sind für Beton ausgelegt.
 ES: ADVERTENCIA: Los tornillos suministrados están hechos para el hormigón.
 IT: ATTENZIONE: Le viti fornite sono fatte per il calcestruzzo.
 NL: WAARSCHUWING: De bijgeleverde schroeven zijn gemaakt voor beton.
 PL: OSTRZEŻENIE: Dostarczone śruby są przeznaczone do betonu.
 PT: AVISO: Os parafusos fornecidos são feitos para betão.

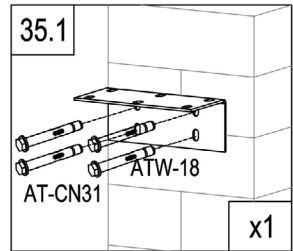
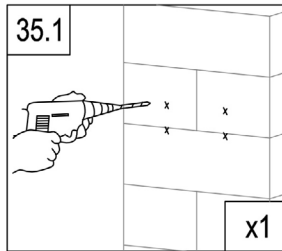
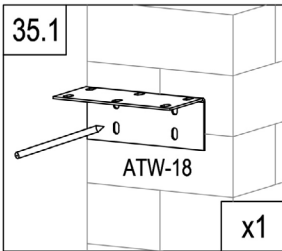

	ATW-18	1
	ATW-18a	1
	AT-20	6
	AT-CN31	4

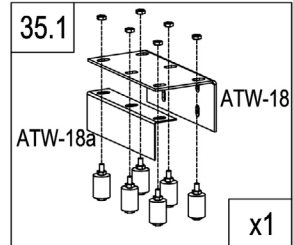
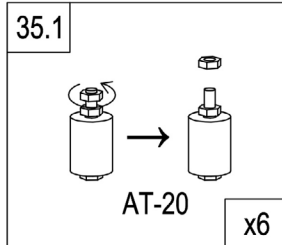

R

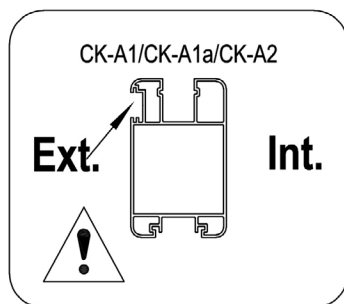
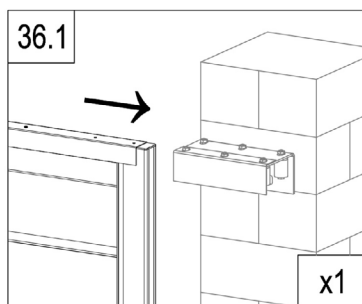
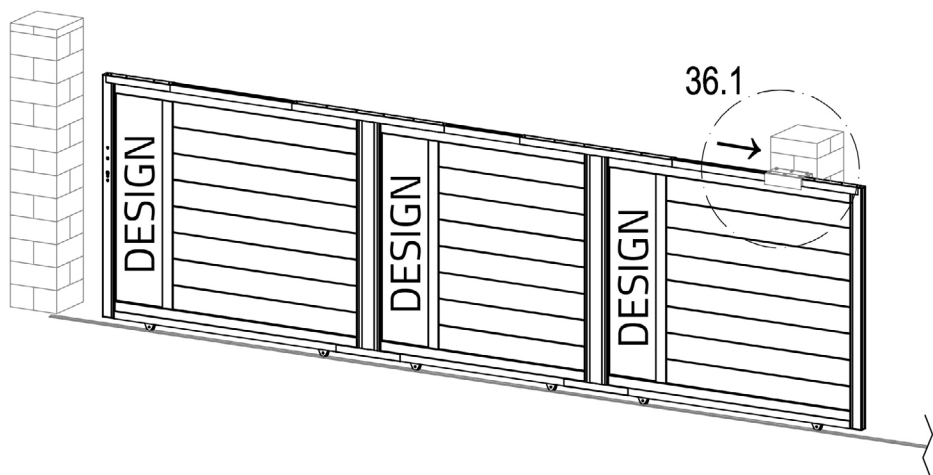

R

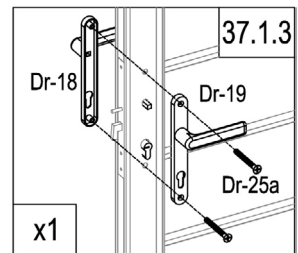
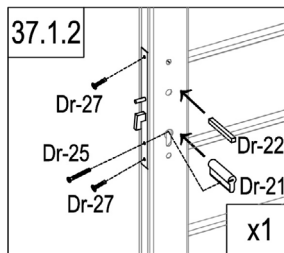
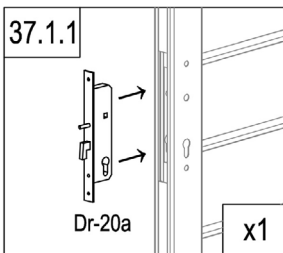
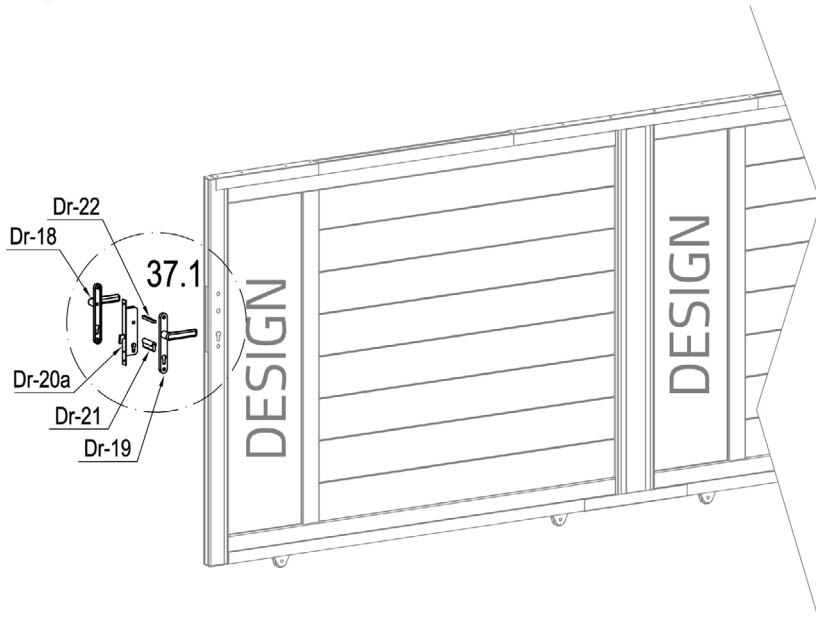

	Dr-20a	1
	Dr-21	1
	Dr-22	1
	Dr-25	1

	Dr-18	1
	Dr-19	1
	Dr-25a	2
	Dr-27	2



EN: WARNING: Screws provided are made for concret.
 FR: AVERTISSEMENT : Les vis fournies sont faites pour le béton.
 DE: WARNUNG: Die mitgelieferten Schrauben sind für Beton ausgelegt.
 ES: ADVERTENCIA: Los tornillos suministrados están hechos para el hormigón.
 IT: ATTENZIONE: Le viti fornite sono fatte per il calcestruzzo.
 NL: WAARSCHUWING: De bijgeleverde schroeven zijn gemaakt voor beton.
 PL: OSTRZEŻENIE: Dostarczone śruby są przeznaczone do betonu.
 PT: AVISO: Os parafusos fornecidos são feitos para betão.

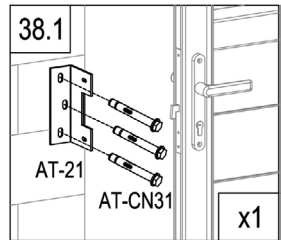
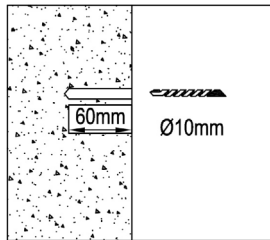
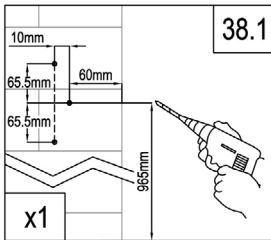
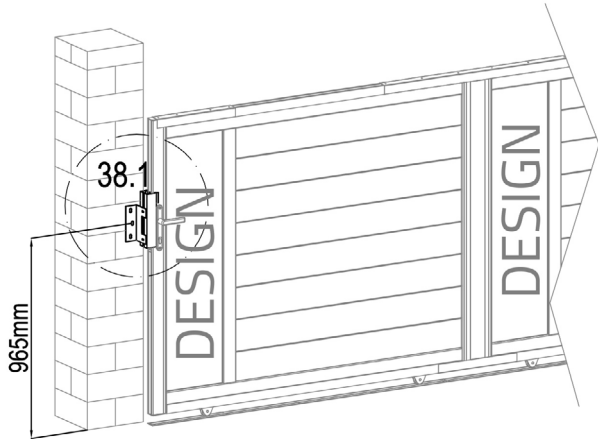
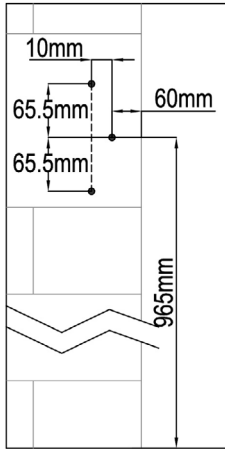

	AT-16	1
	AT-21	1
	AT-CN36	2
	AT-CN31	3
	AT-22J	3

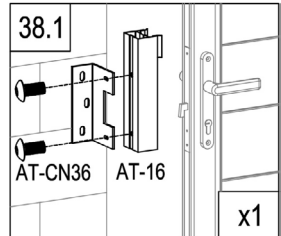
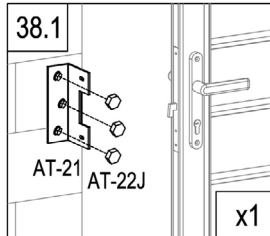

R

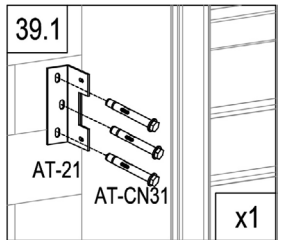
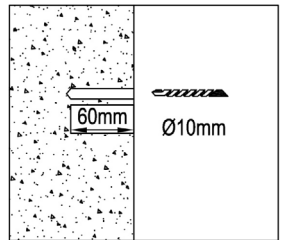
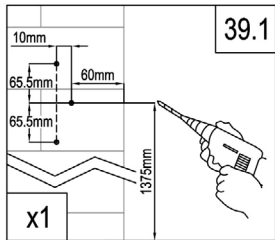
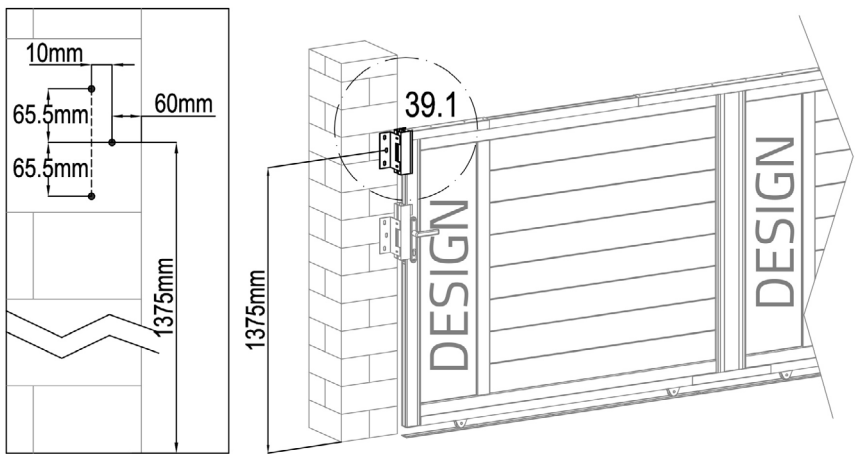

	AT-16a	1
	AT-21	1
	AT-CN36	2
	AT-CN31	3
	AT-22J	3

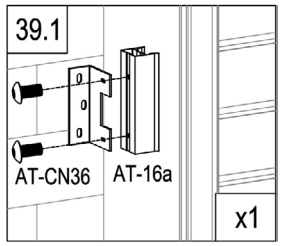
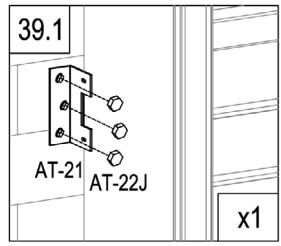

R

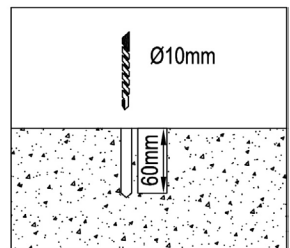
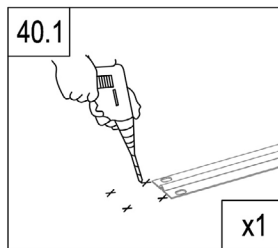
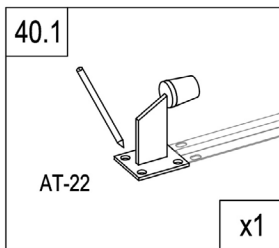
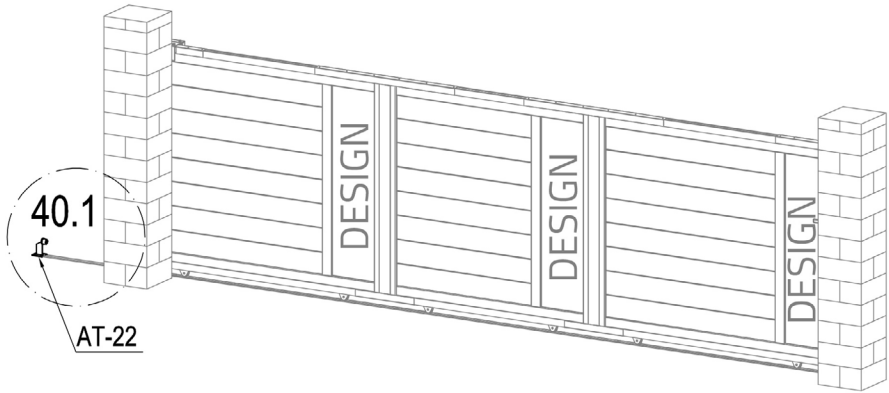

	AT-22	1
	AT-CN31	4
	AT-22J	4

