

CASANOVO

LIFE 300B120

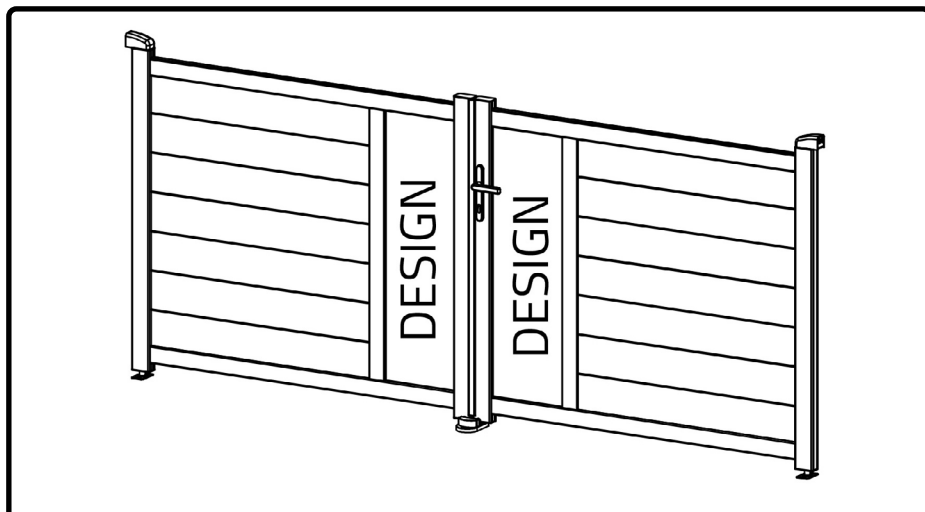

COM-001069 [x1]

COM-001078 [x1]

COM-001070 [x1]



7-8H



X 2





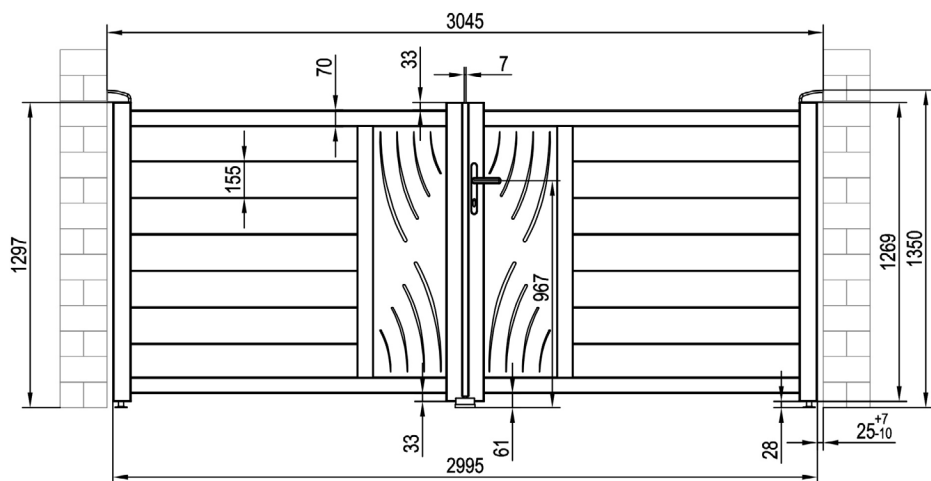

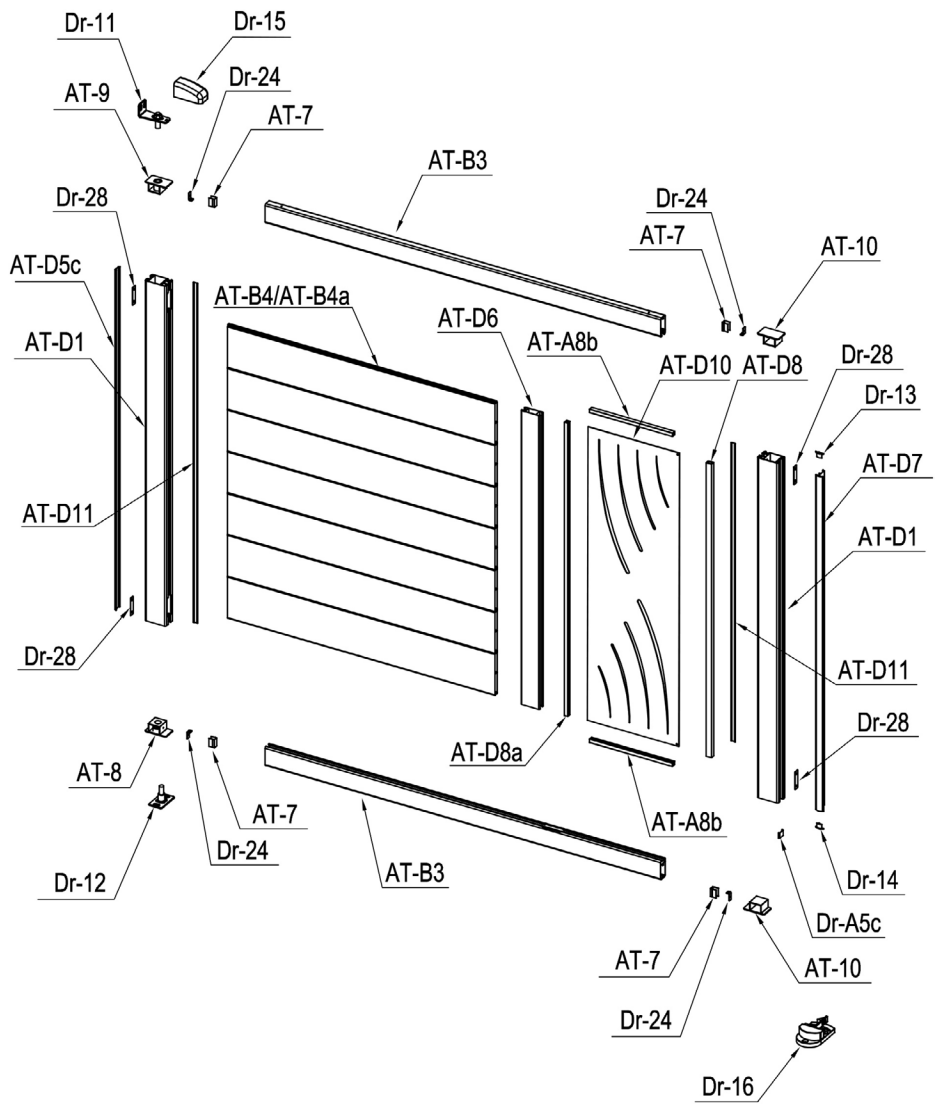

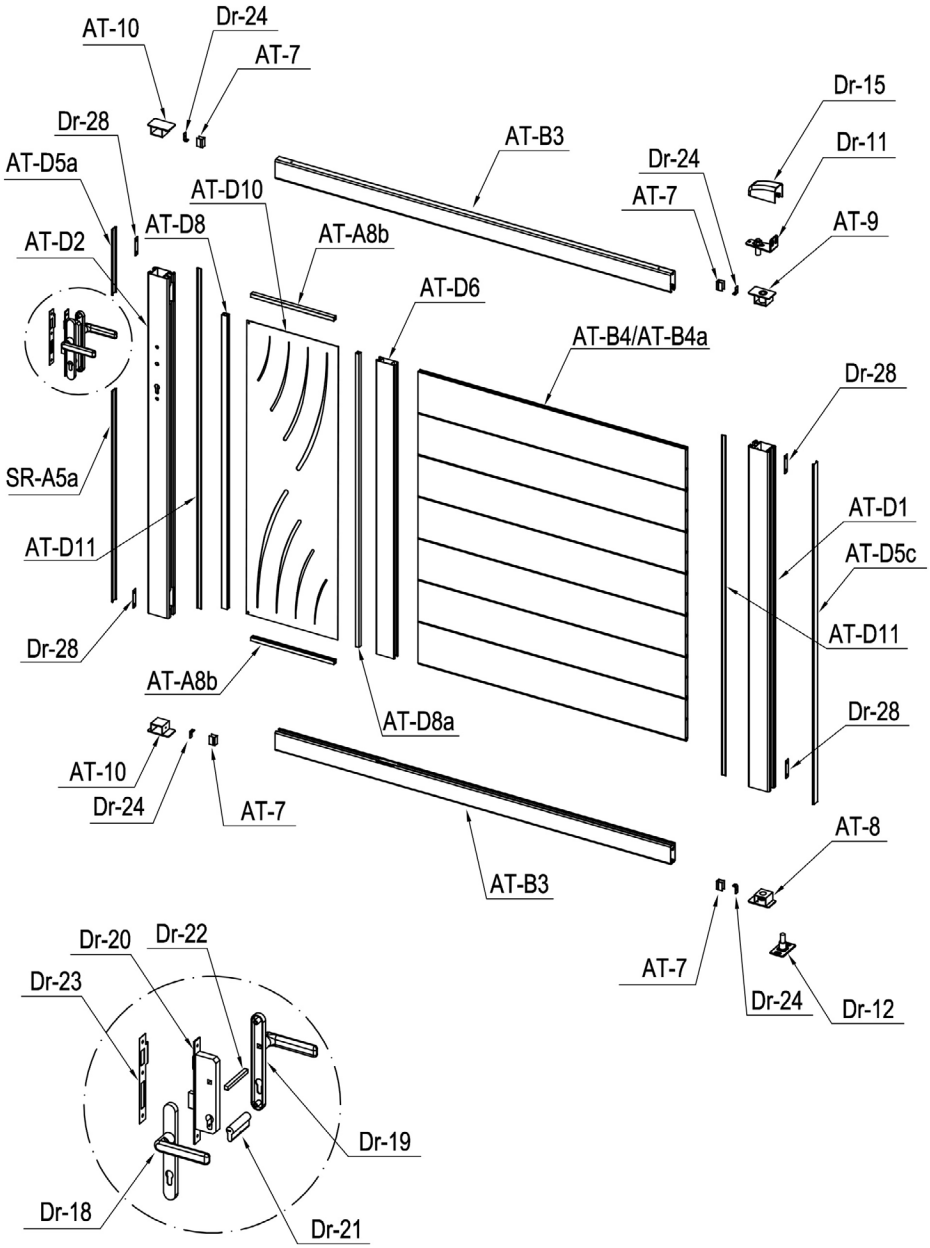



































INSTRUCTION MANUAL / NOTICE DE MONTAGE / MONTAGEANLEITUNG / MANUAL DE MONTAJE / MANUAL DE MONTAGEM / MANUALE DI MONTAGGIO /
MONTAGEHANDLEIDING / INSTRUKCJA MONTAŻU / KÄYTTÖOHJEET / BRUKSANVISNING / BRUGSANVISNING / INSTRUCIUNI DE ASAMBLARE /
NAVODILA ZA SESTAVLJANJE / NÁVOD NA MONTÁŽ / ÖSSZESZERELÉSI ÚTMUTATÓ / NÁVOD K MONTÁŽI / UPUTE ZA INSTALACIJU /
ΟΔΗΓΙΕΣ ΣΥΝΑΡΜΟΛΟΓΗΣΗΣ / SURINKIMO INSTRUKCIJOS / MONTĀŽAS INSTRUKCIJAS







PART LIST

IMAGE	NO.	L.(mm)	QTY	IMAGE	NO.	L.(mm)	QTY
	AT-D1	1263	3		Dr-15		2
	AT-D2	1263	1		Dr-16		1
	AT-B3	1471	4		Dr-17		2
	AT-D6	1091	2		Dr-31		4
	AT-B4	995	12		Dr-18		1
	AT-B4a (+AT-B15)	995	2		Dr-19		1
	AT-D10	1088	2		Dr-20		1
	AT-D8	1090	2		Dr-21		1
	AT-D8a	1090	2		Dr-22		1
	AT-A8b	308.5	4		Dr-23		1
	AT-D5c	1263	2		Dr-25		1
	AT-D5a	240.5	1		Dr-25a		2
	SR-A5a	782	1		Dr-26		3
	Dr-A5c	19.5	1		Dr-27		2
	AT-D11	1263	4		Dr-24		8
	AT-7	29.5	8		Dr-28		8
	AT-D7	1243	1		AT-BK30	ST4x10	8
	AT-8		2		AT-BK31	ST4.2x13	8
	AT-9		2		AT-BK32	M8x60	12
	AT-10		4		AT-BK33	ST5.5x38	16
	Dr-11		2		AT-BK34	ST6x40	3
	Dr-12		2		AT-BK35	Ø6	3
	Dr-13		1		AT-BK36	ST4.8x38	50
	Dr-14		1		AT-BK37	ST4.2x13	8

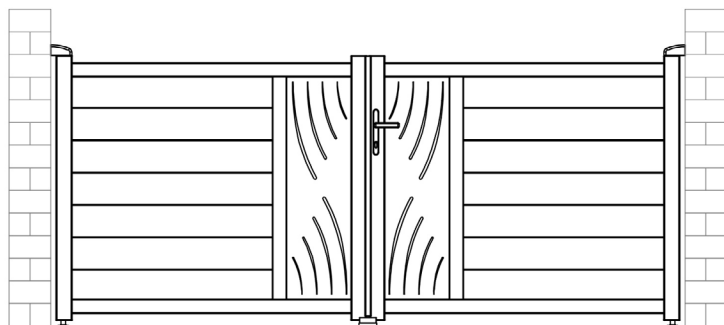

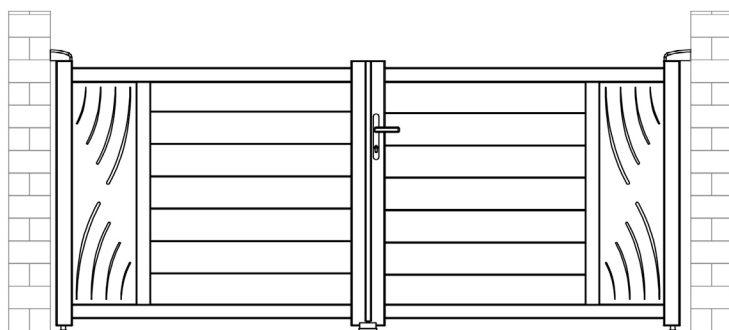

A

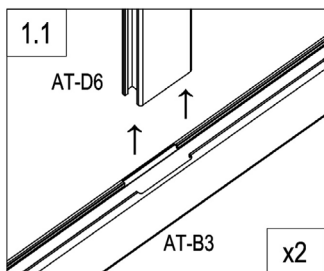
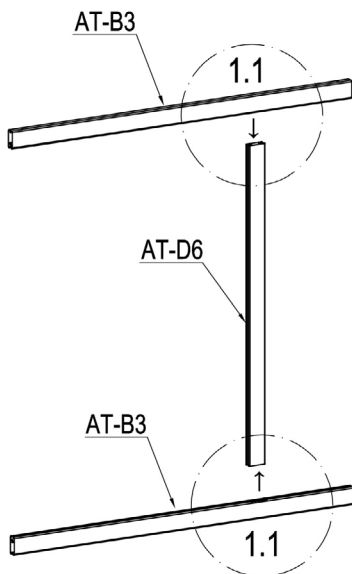

B

A



	AT-D6	1
	AT-B3	2

A

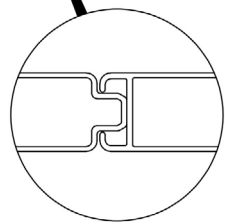
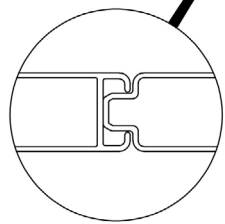
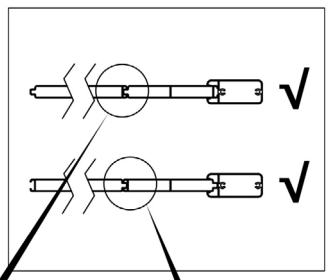
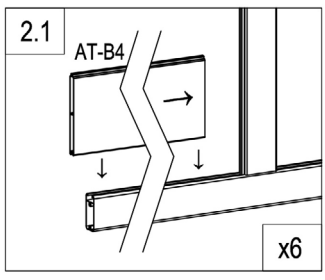
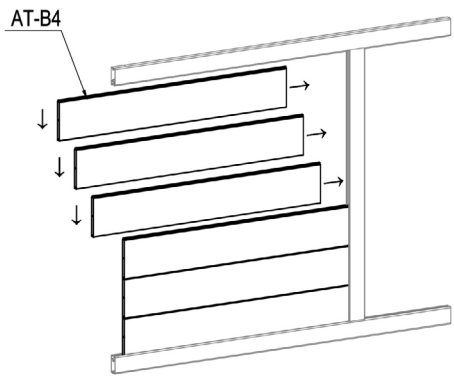

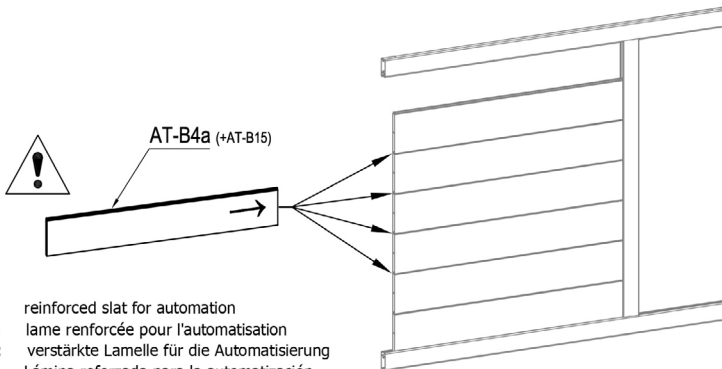

	AT-B4	6
---	-------	---

A

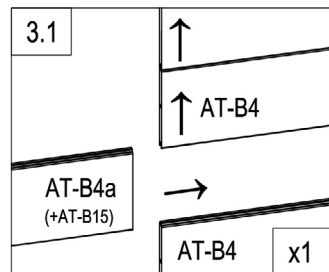
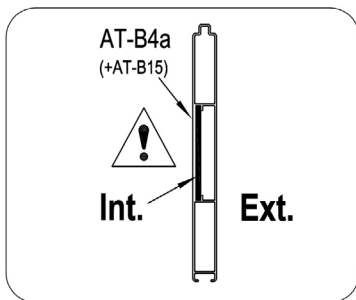

- EN: reinforced slat for automation
- FR : lame renforcée pour l'automatisation
- DE : verstärkte Lamelle für die Automatisierung
- ES: Lámina reforzada para la automatización
- PT: ripa reforçada para automatização
- IT: lamella rinforzata per l'automazione
- NL: versterkte lat voor automatisering
- PL: wzmocniona listwa do automatyzacji



	AT-B4a (+AT-B15)	1
---	------------------	---

A

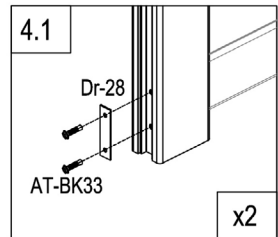
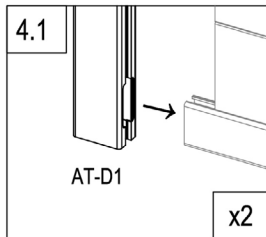
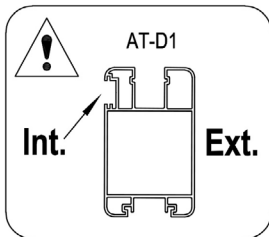
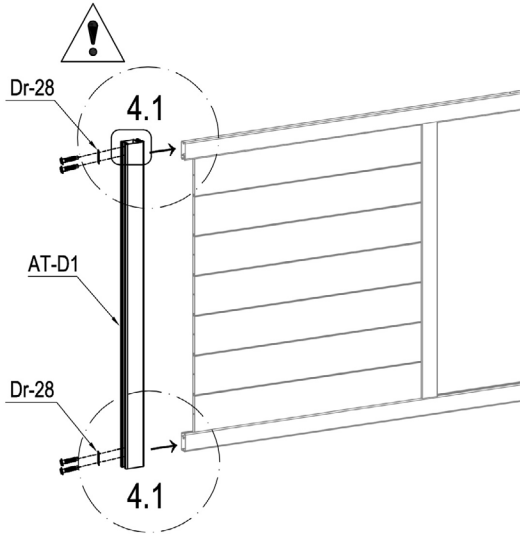

	AT-D1	1
	Dr-28	2
	AT-BK33	4

A

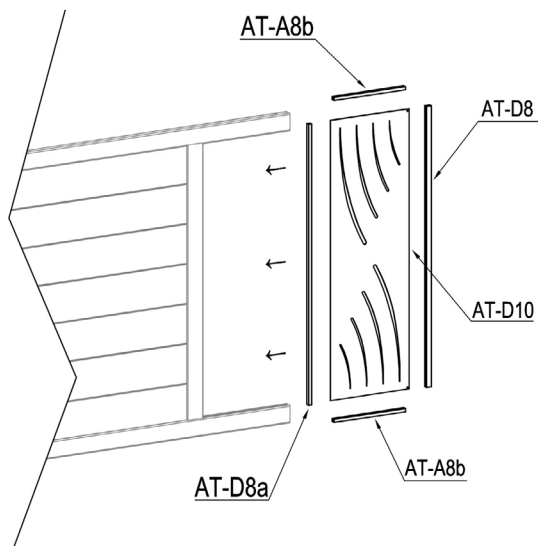

EN :you can flip and switch the direction of this plate to personalize your gate
 FR: vous pouvez retourner et changer la direction de cette plaque pour personnaliser votre portail
 DE: Sie können dieses Schild umdrehen und die Richtung wechseln, um Ihr Tor zu personalisieren.
 ES: puedes girar y cambiar la dirección de esta placa para personalizar tu puerta
 PT: pode virar e mudar a direção desta placa para personalizar o seu portão
 IT: potete capovolgere e cambiare la direzione di questa piastra per personalizzare il vostro cancello
 NL: u kunt de richting van deze plaat omdraaien en veranderen om uw poort te verpersoonlijken...
 PL: można obrócić i przełączyć kierunek tej płyty, aby spersonalizować bramę.

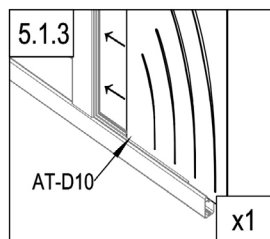
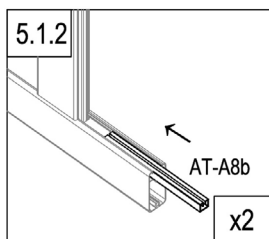
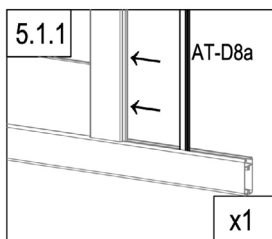

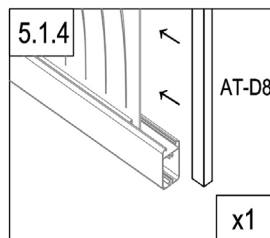

	AT-D8a	1
	AT-A8b	2
	AT-D10	1
	AT-D8	1

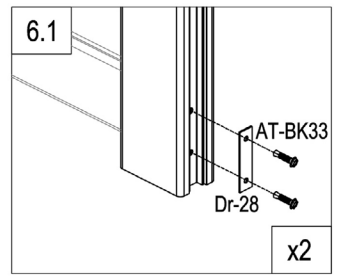
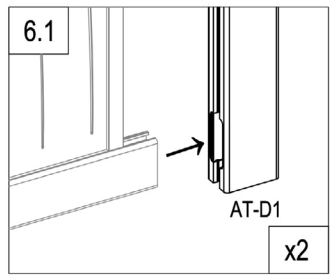
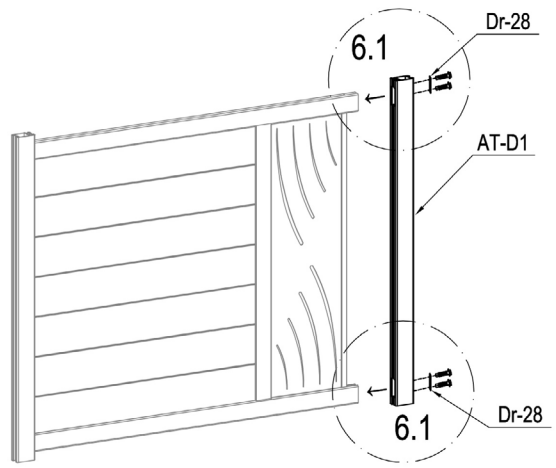

A



	AT-D1	1
	Dr-28	2
	AT-BK33	4

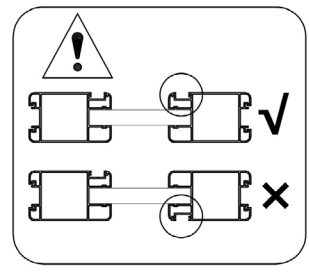

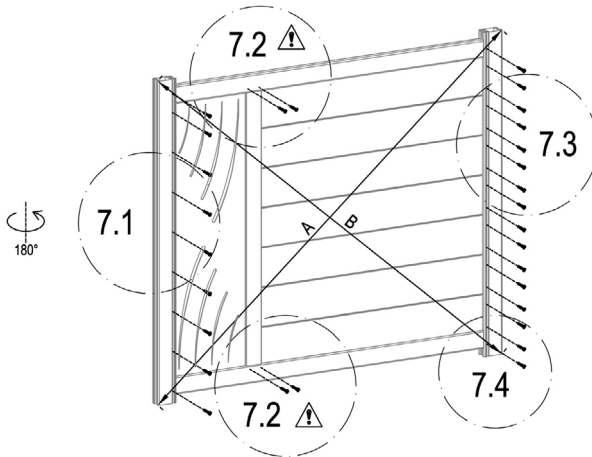

A



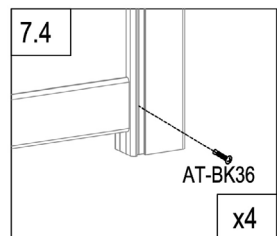
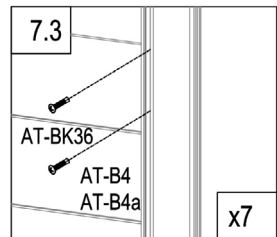
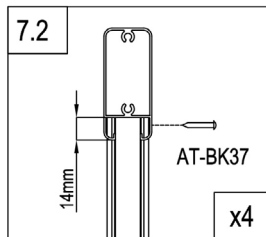
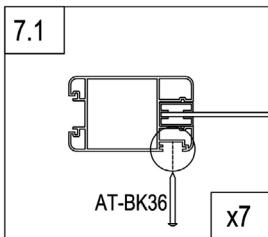

A=B

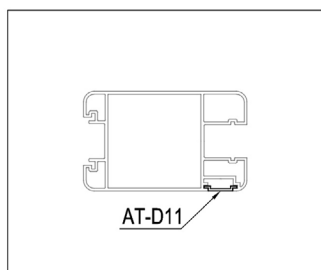
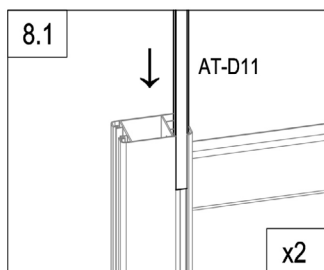
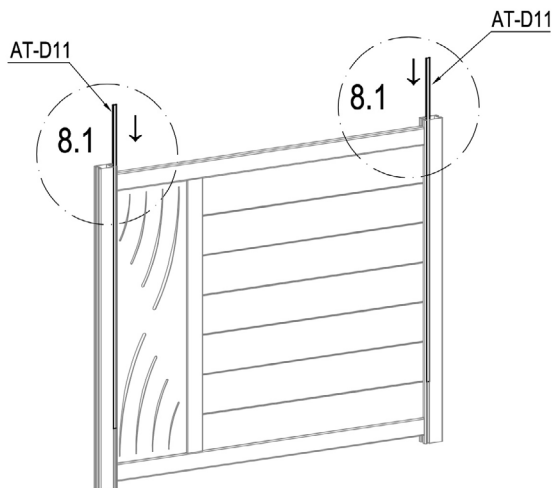

	AT-BK36	25
	AT-BK37	4

A



	AT-D11	2
---	--------	---

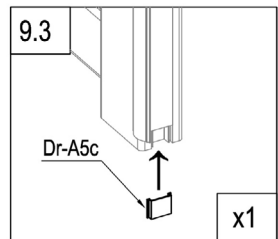
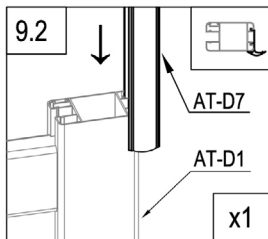
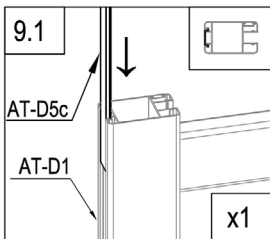
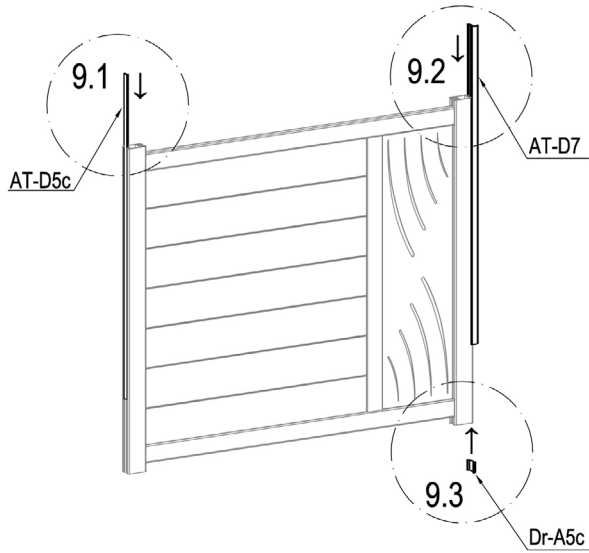

A



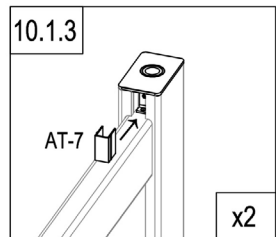
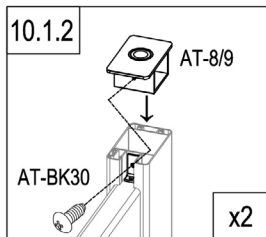
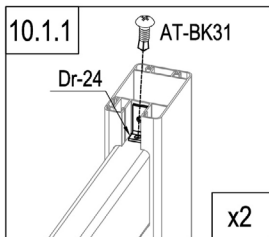
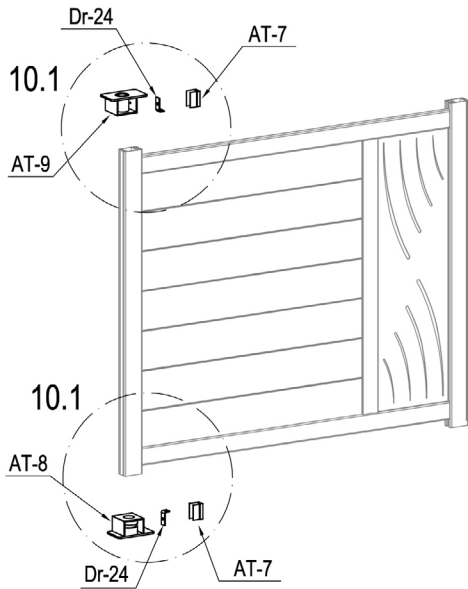

	AT-D5c	1
	Dr-A5c	1
	AT-D7	1

A



	AT-8	1
	AT-9	1
	Dr-24	2

	AT-7	2
	AT-BK30	2
	AT-BK31	2

A

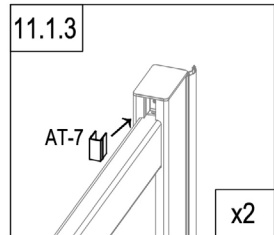
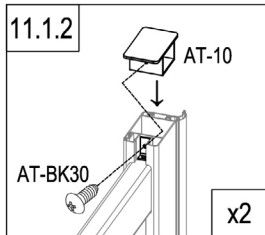
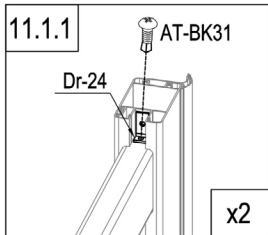
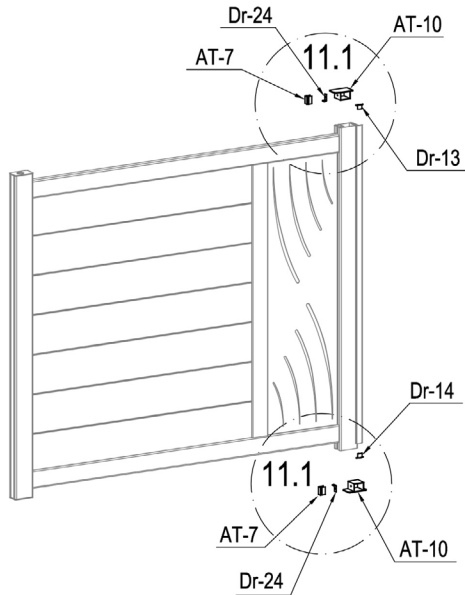

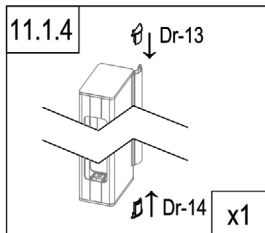

	AT-10	2
	Dr-24	2
	AT-7	2
	Dr-13	1



	DR-14	1
	AT-BK30	2
	AT-BK31	2

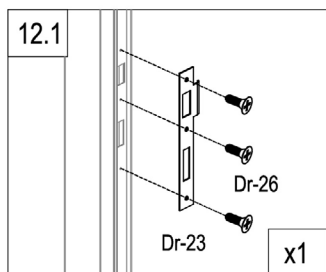
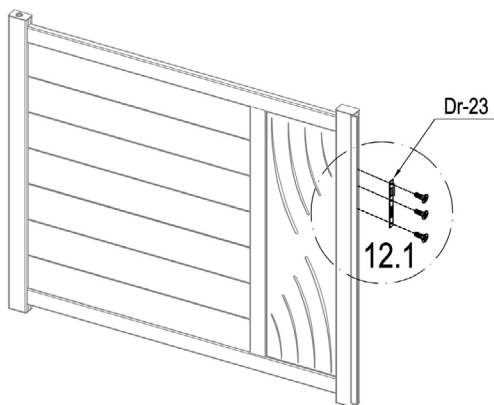

A

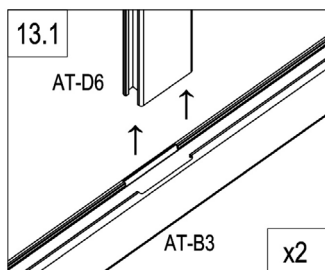
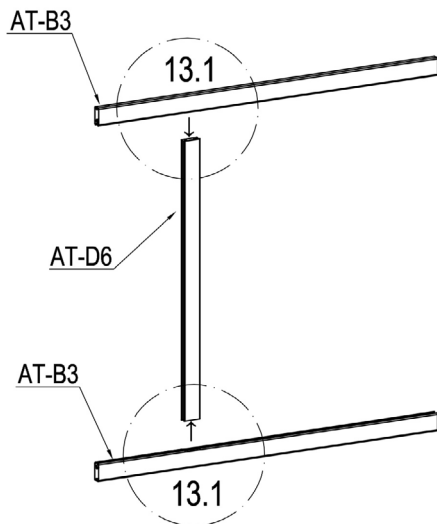

	Dr-23	1
	Dr-26	3

A



	AT-D6	1
	AT-B3	2

A

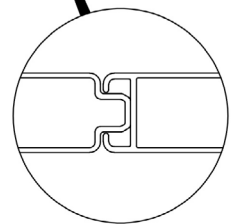
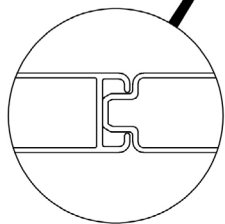
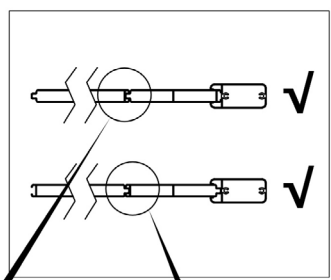
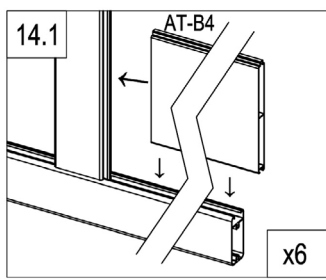
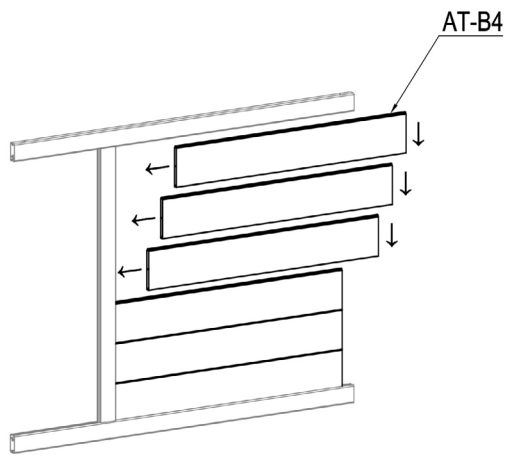

	AT-B4	6
---	-------	---

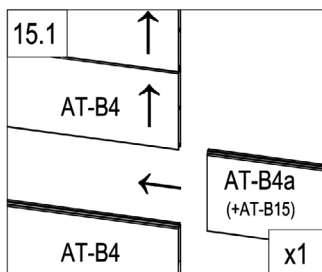
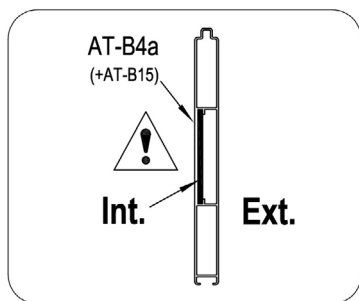
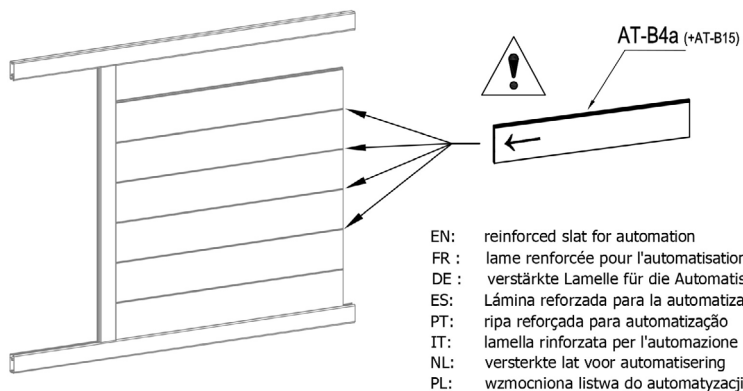

A

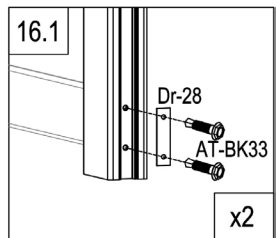
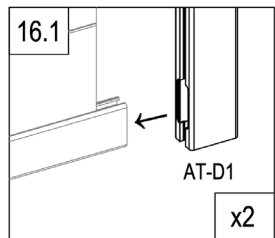
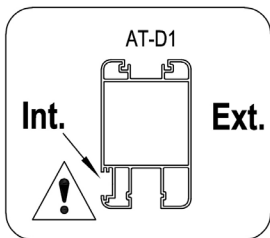
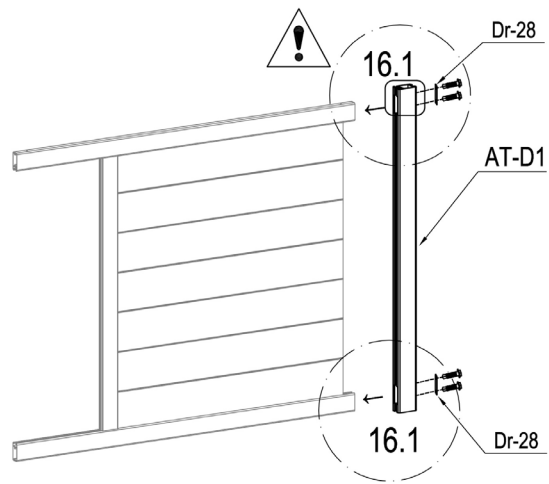

	AT-B4a (+AT-B15)	1
--	------------------	---

A



	AT-D1	1
	Dr-28	2
	AT-BK33	4

A

EN :you can flip and switch the direction of this plate to personalize your gate
 FR: vous pouvez retourner et changer la direction de cette plaque pour personnaliser votre portail
 DE: Sie können dieses Schild umdrehen und die Richtung wechseln, um Ihr Tor zu personalisieren.
 ES: puedes girar y cambiar la dirección de esta placa para personalizar tu puerta
 PT: pode virar e mudar a direção desta placa para personalizar o seu portão
 IT: potete capovolgere e cambiare la direzione di questa piastra per personalizzare il vostro cancello
 NL: u kunt de richting van deze plaat omdraaien en veranderen om uw poort te verpersoonlijken...
 PL: można obrócić i przełączyć kierunek tej płyty, aby spersonalizować bramę.

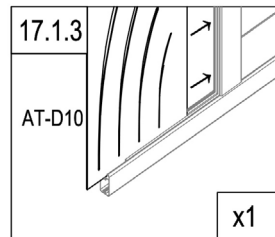
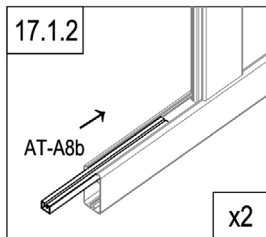
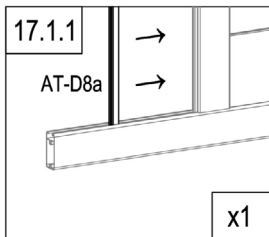
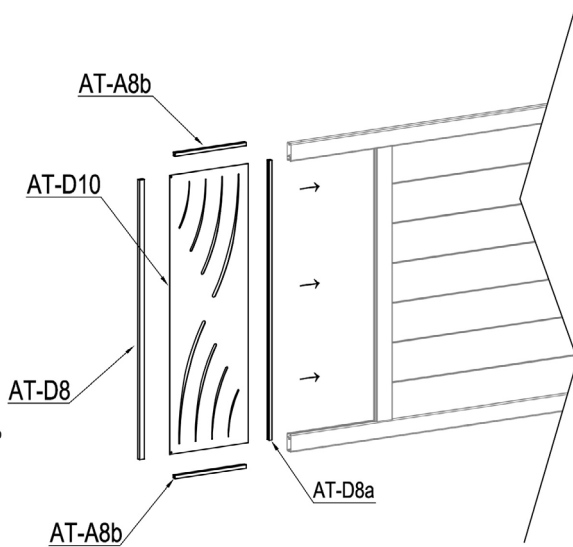

	AT-D8a	1
	AT-A8b	2
	AT-D10	1
	AT-D8	1

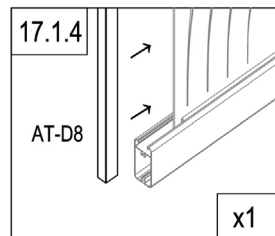

A

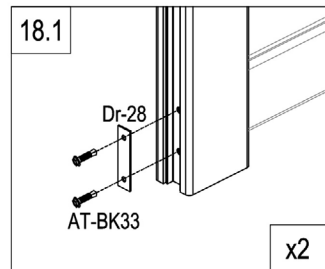
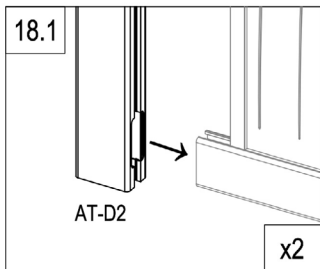
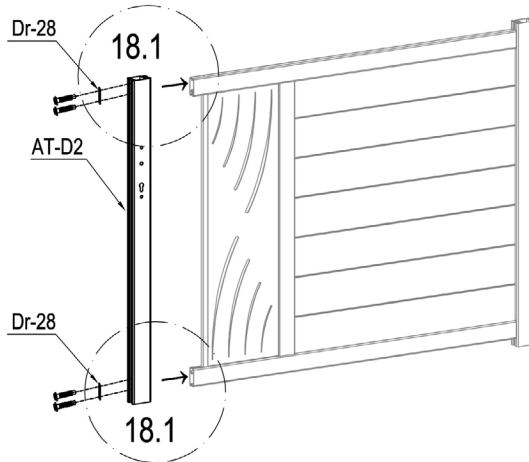

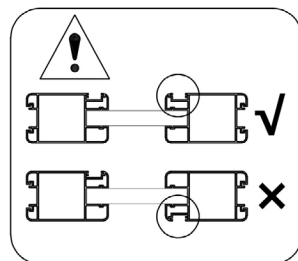

	AT-D2	1
	Dr-28	2
	AT-BK33	4



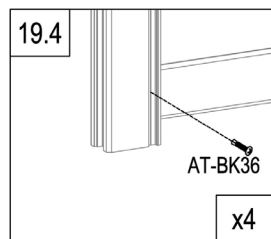
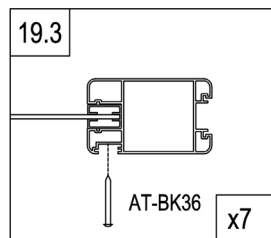
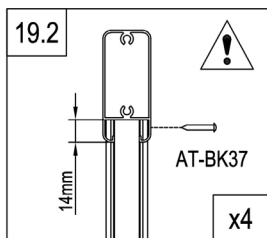
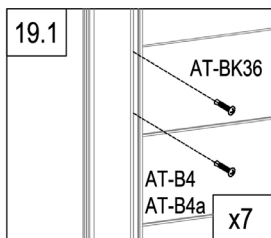
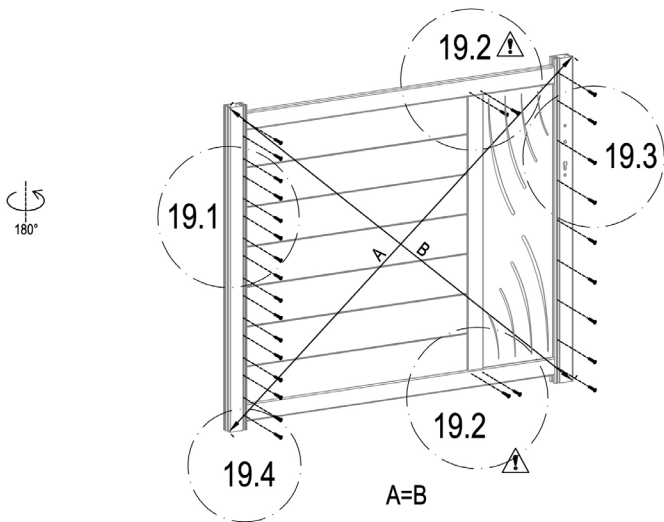

A

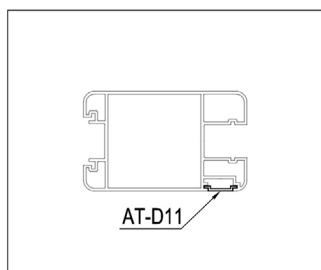
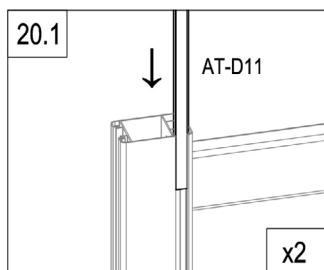
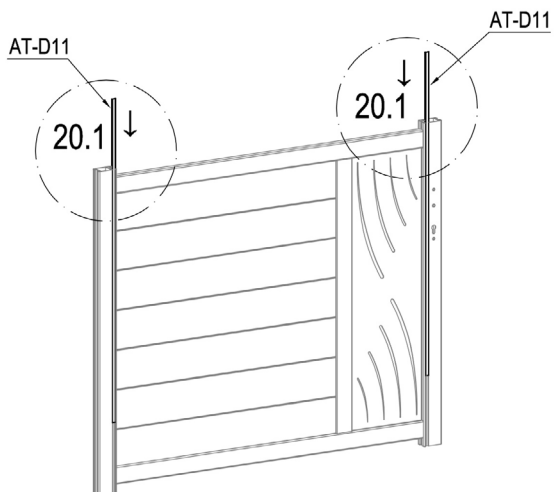

	AT-BK36	25
	AT-BK37	4

A



	AT-D11	2
---	--------	---

A

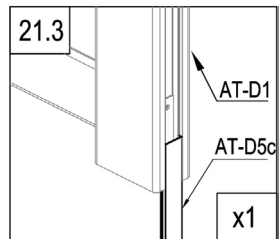
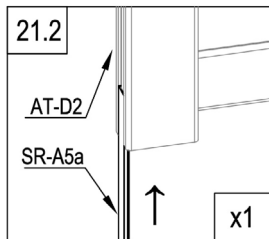
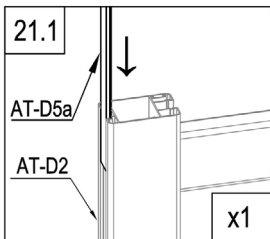
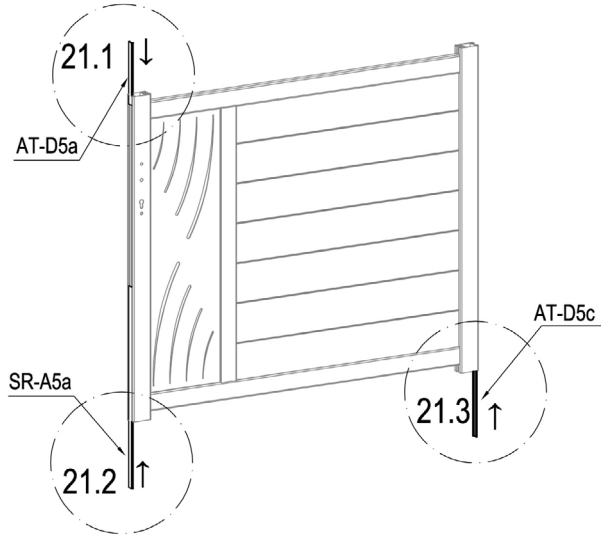

	AT-D5c	1
	AT-D5a	1
	SR-A5a	1

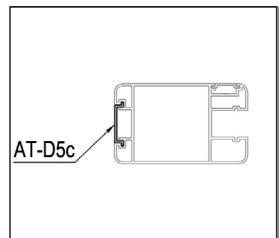

A

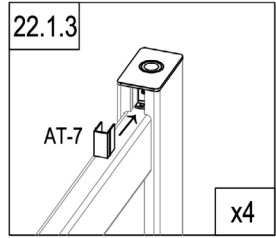
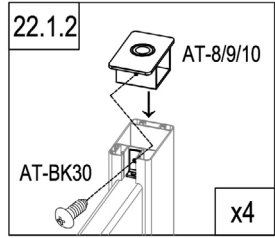
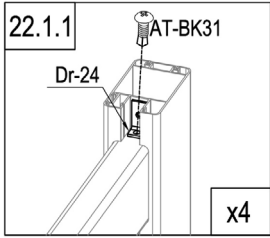
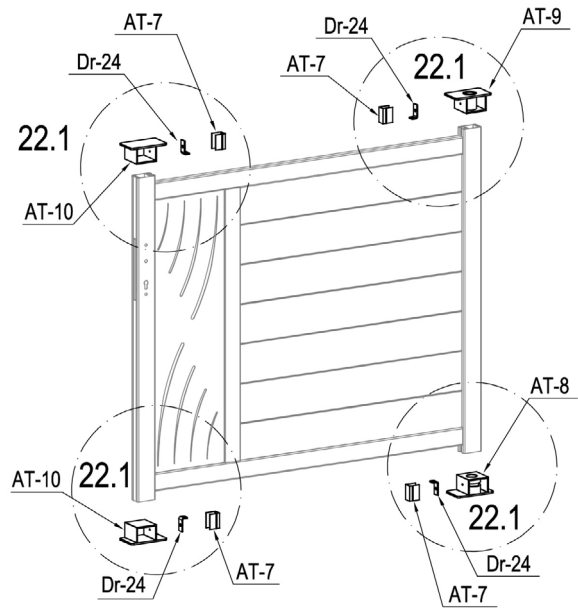

	AT-8	1
	AT-9	1
	AT-10	2
	Dr-24	4

	AT-7	4
	AT-BK30	4
	AT-BK31	4

A

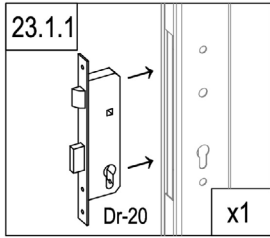
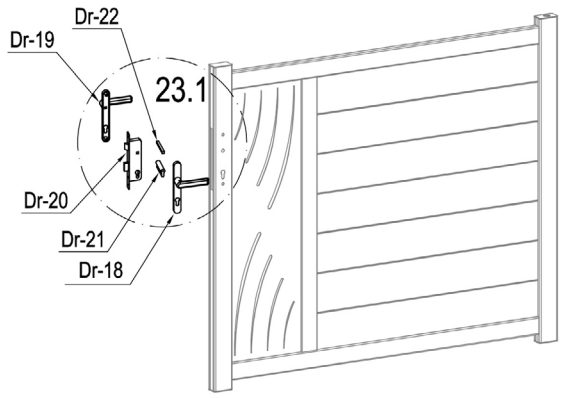

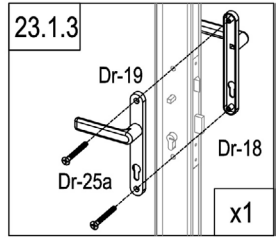
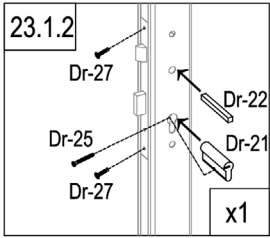

	Dr-20	1
	Dr-21	1
	Dr-22	1
	Dr-25	1

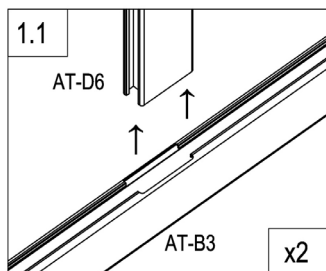
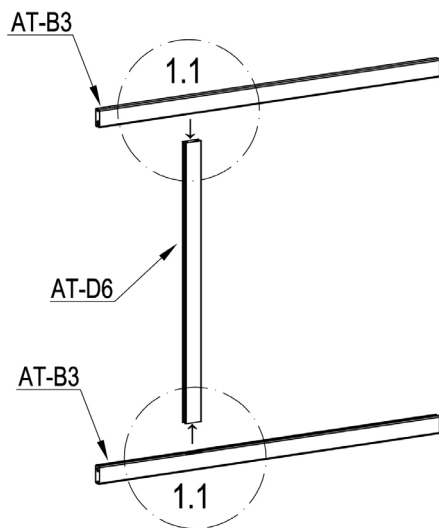

	Dr-18	1
	Dr-19	1
	Dr-25a	2
	Dr-27	2

B



	AT-D6	1
	AT-B3	2

B

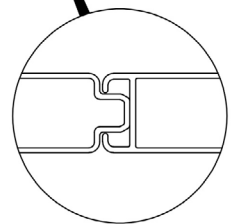
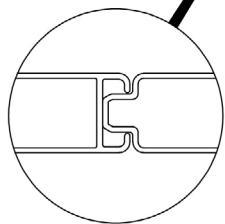
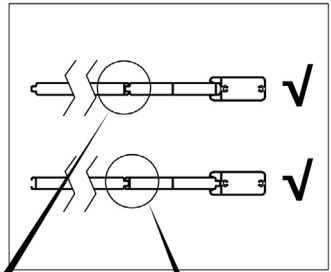
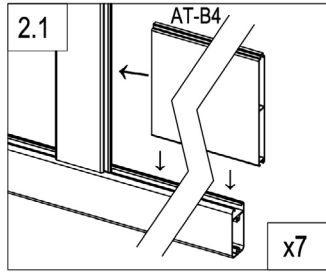
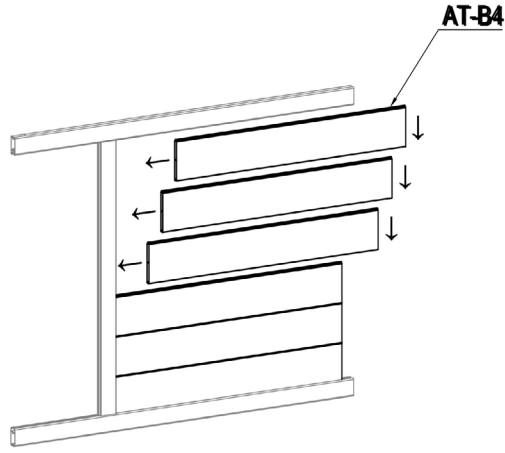

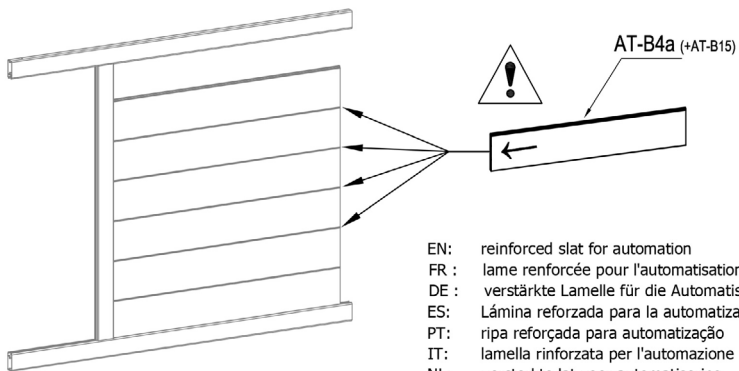

	AT-B4	7
---	-------	---

B



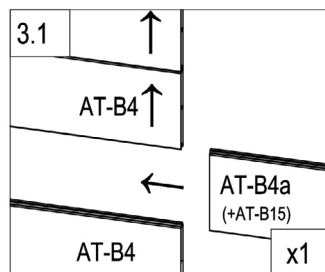
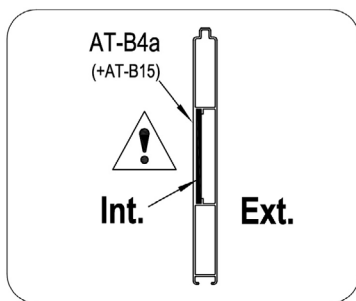



- EN: reinforced slat for automation
- FR : lame renforcée pour l'automatisation
- DE : verstärkte Lamelle für die Automatisierung
- ES: Lámina reforzada para la automatización
- PT: ripa reforçada para automatização
- IT: lamella rinforzata per l'automazione
- NL: versterkte lat voor automatisering
- PL: wzmacniona listwa do automatyzacji

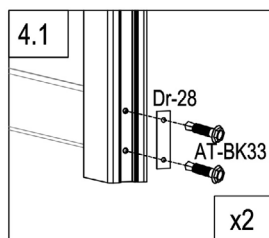
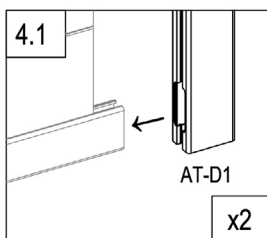
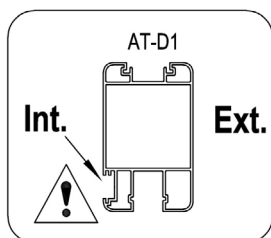
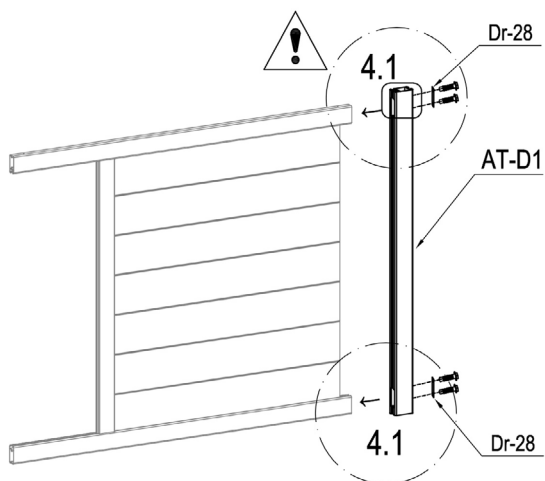

	AT-B4a (+AT-B15)	1
---	------------------	---

B



	AT-D1	1
	Dr-28	2
	AT-BK33	4

B

EN : you can flip and switch the direction of this plate to personalize your gate

FR: vous pouvez retourner et changer la direction de cette plaque pour personnaliser votre portail

DE: Sie können dieses Schild umdrehen und die Richtung wechseln, um Ihr Tor zu personalisieren.

ES: puedes girar y cambiar la dirección de esta placa para personalizar tu puerta

PT: pode virar e mudar a direção desta placa para personalizar o seu portão

IT: potete capovolgere e cambiare la direzione di questa piastra per personalizzare il vostro cancello

NL: u kunt de richting van deze plaat omdraaien en veranderen om uw poort te verpersoonlijken...

PL: można obrócić i przełączyć kierunek tej płyty, aby spersonalizować bramę.

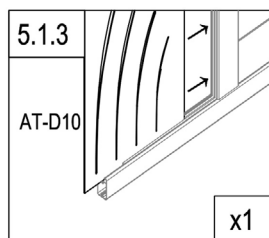
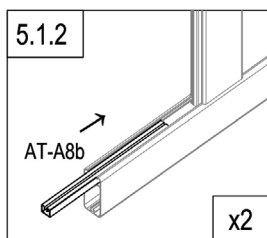
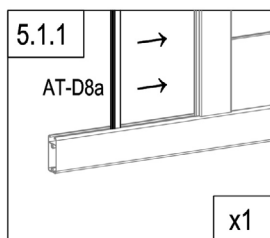
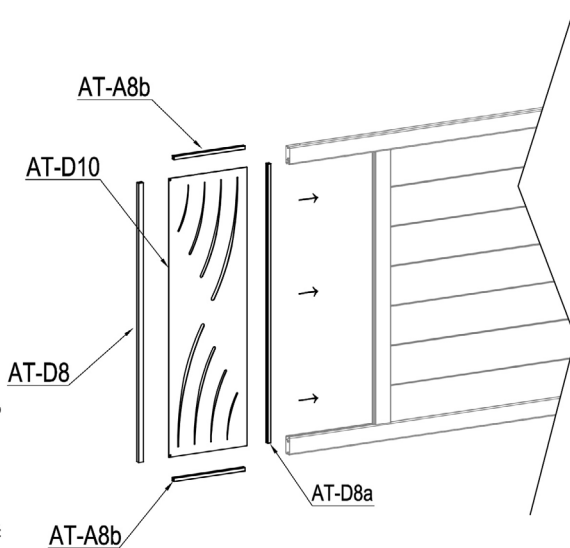

	AT-D8a	1
	AT-A8b	2
	AT-D10	1
	AT-D8	1

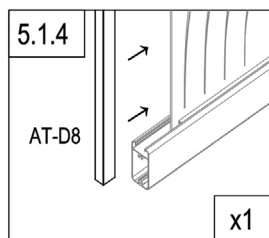

B

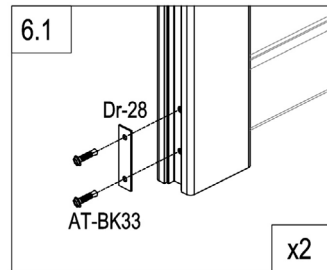
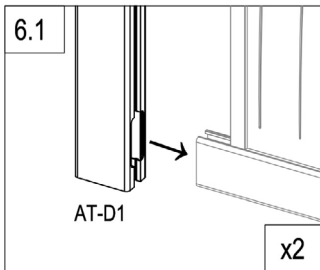
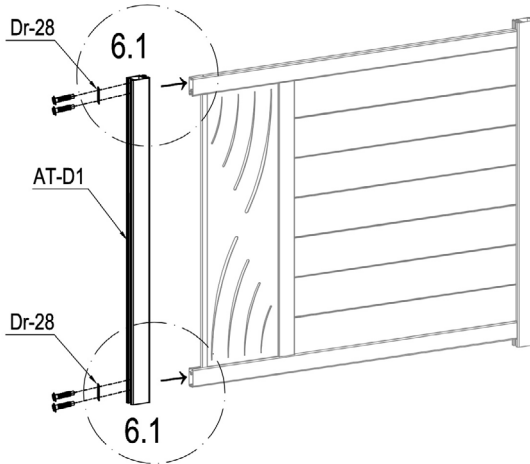

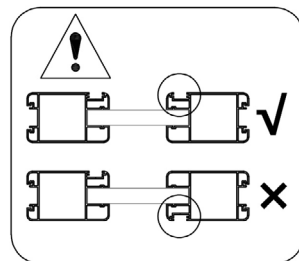

	AT-D1	1
	Dr-28	2
	AT-BK33	4



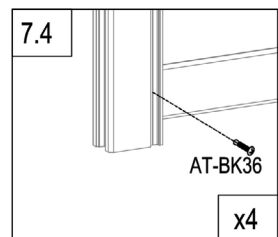
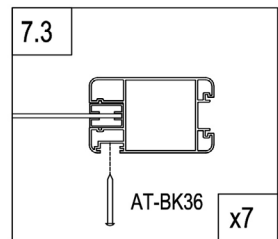
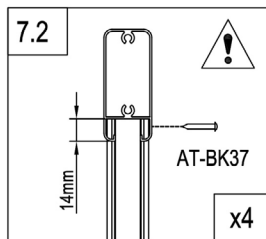
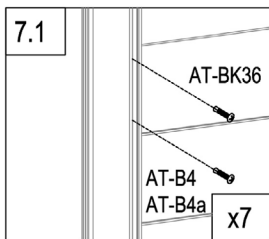
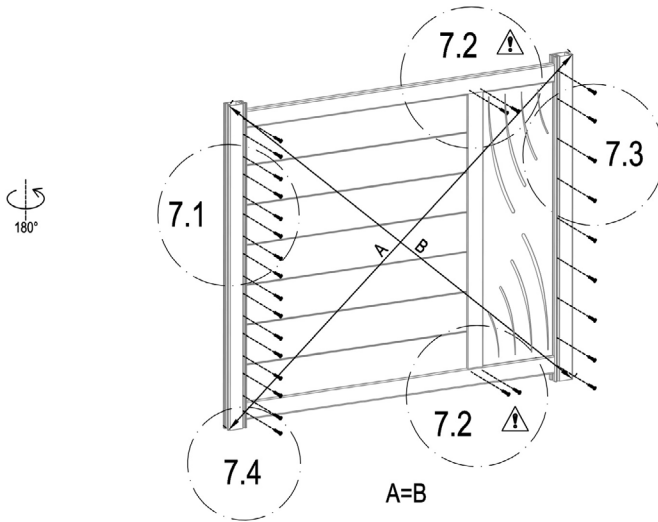

B



	AT-BK36	25
	AT-BK37	4

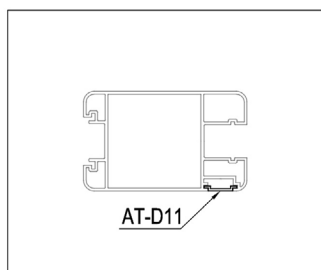
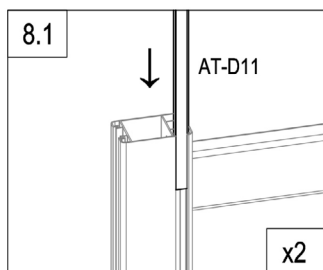
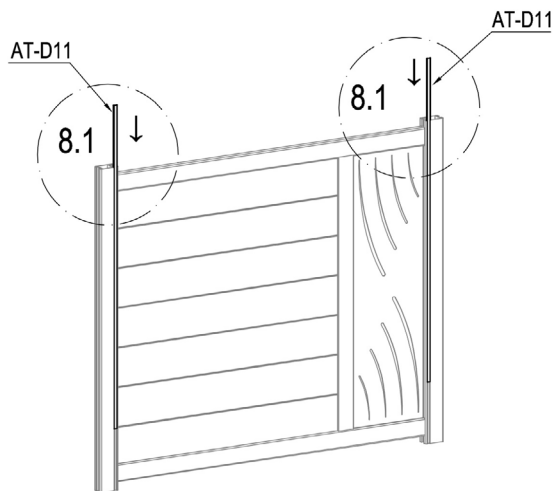

B

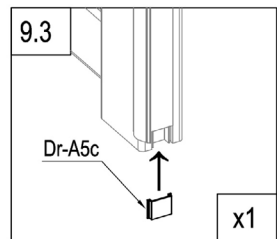
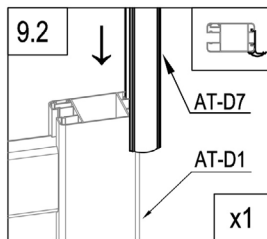
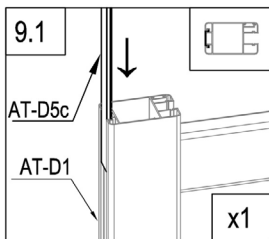
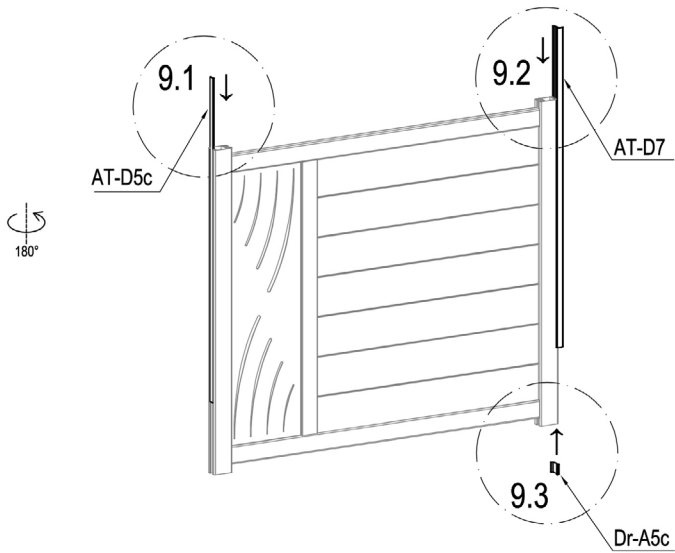

	AT-D11	2
---	--------	---

B



	AT-D5c	1
	Dr-A5c	1
	AT-D7	1

B

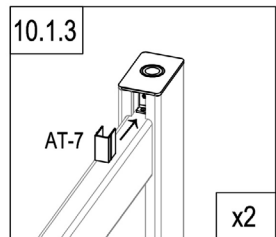
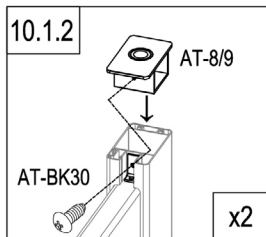
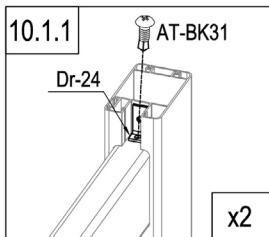
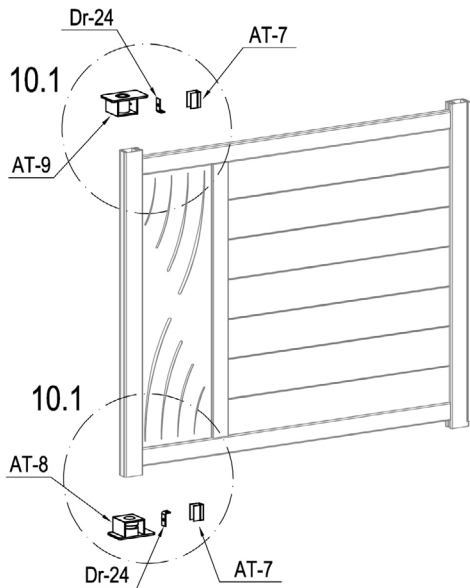

	AT-8	1
	AT-9	1
	Dr-24	2

	AT-7	2
	AT-BK30	2
	AT-BK31	2

B

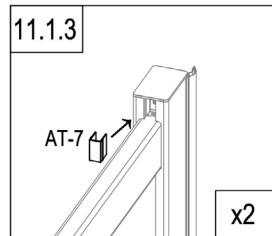
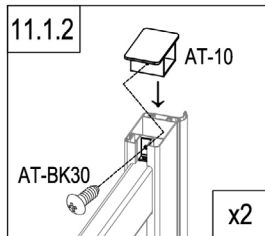
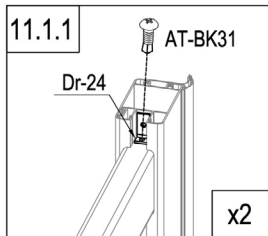
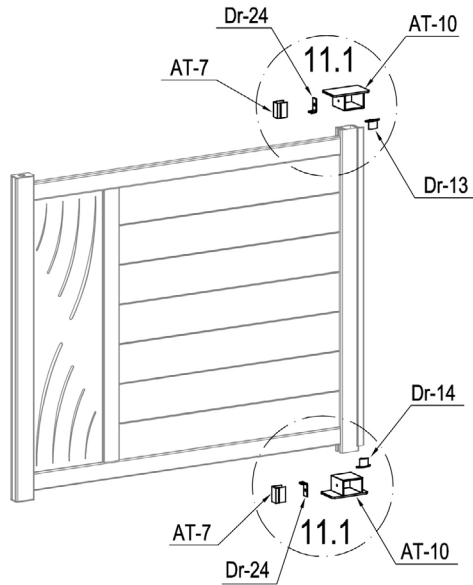

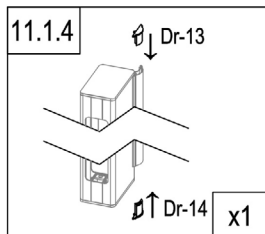

	AT-10	2
	Dr-24	2
	AT-7	2
	Dr-13	1



	DR-14	1
	AT-BK30	2
	AT-BK31	2

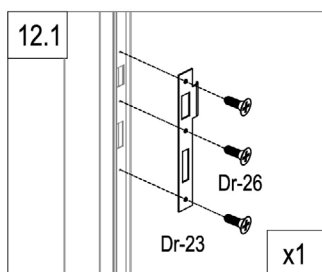
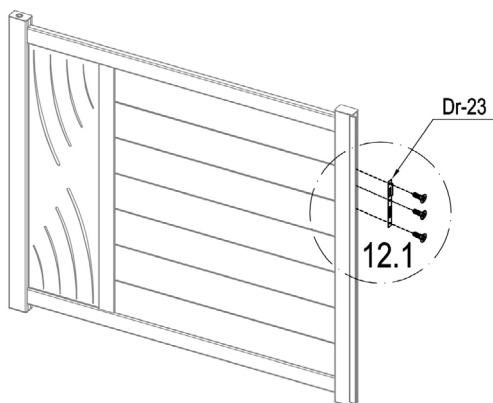

B

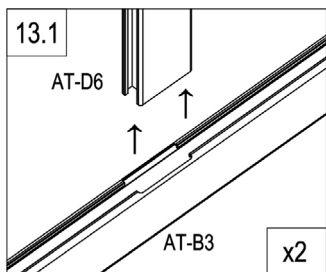
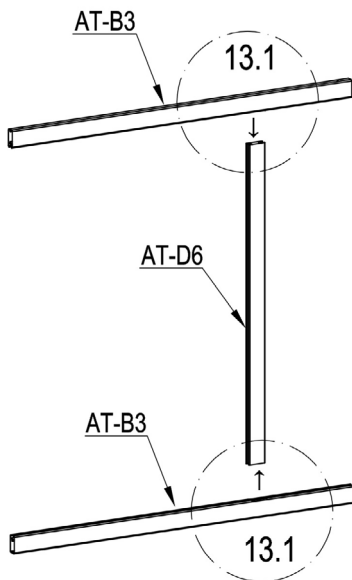

	Dr-23	1
	Dr-26	3

B



	AT-D6	1
	AT-B3	2

B

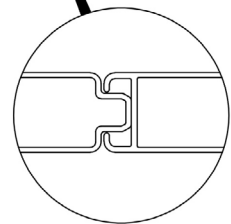
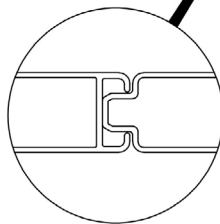
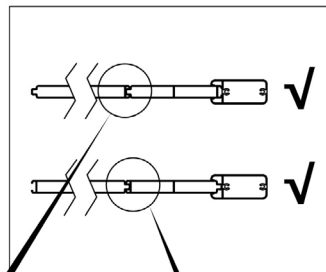
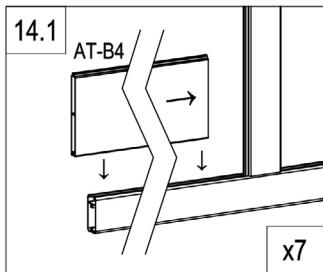
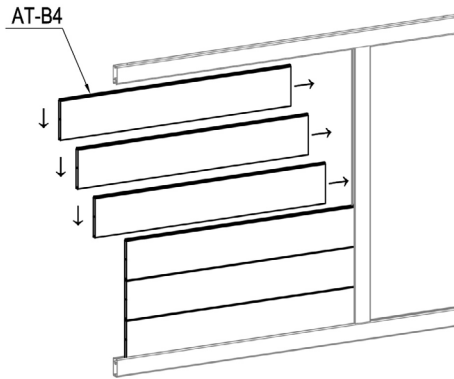

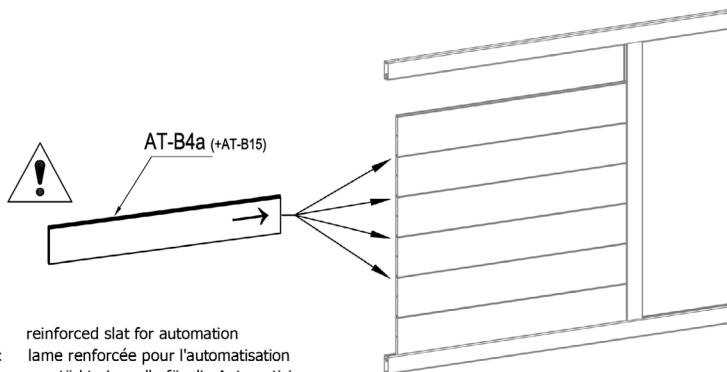

	AT-B4	7
---	-------	---

B



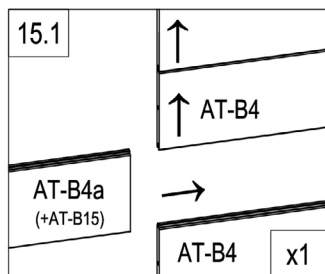
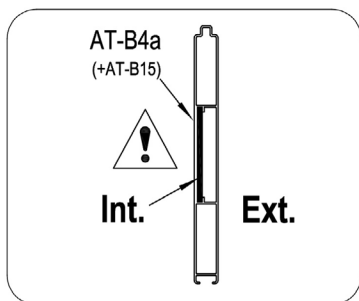



- EN: reinforced slat for automation
 FR : lame renforcée pour l'automatisation
 DE : verstärkte Lamelle für die Automatisierung
 ES: Lámina reforzada para la automatización
 PT: ripa reforçada para automatização
 IT: lamella rinforzata per l'automazione
 NL: versterkte lat voor automatisering
 PL: wzmocniona listwa do automatyzacji

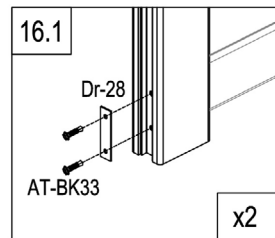
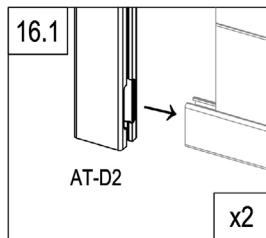
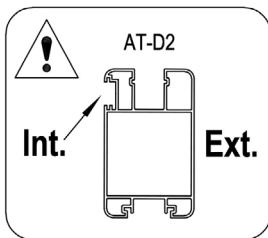
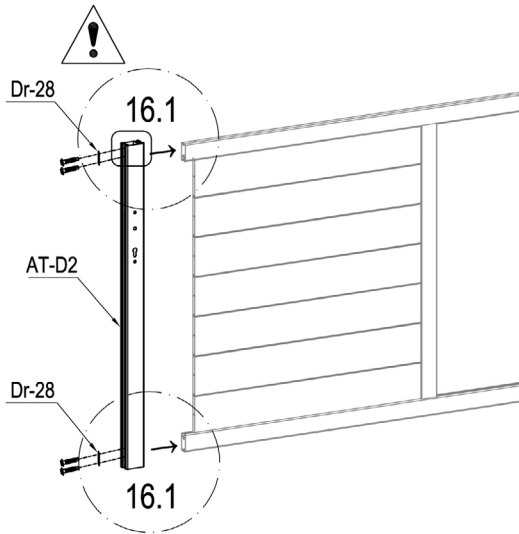

	AT-B4a (+AT-B15)	1
---	------------------	---

B



	AT-D2	1
	Dr-28	2
	AT-BK33	4

B

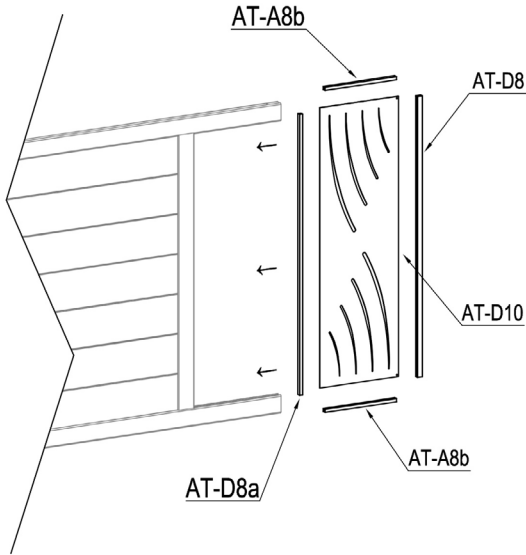

EN :you can flip and switch the direction of this plate to personalize your gate
 FR: vous pouvez retourner et changer la direction de cette plaque pour personnaliser votre portail
 DE: Sie können dieses Schild umdrehen und die Richtung wechseln, um Ihr Tor zu personalisieren.
 ES: puedes girar y cambiar la dirección de esta placa para personalizar tu puerta
 PT: pode virar e mudar a direção desta placa para personalizar o seu portão
 IT: potete capovolgere e cambiare la direzione di questa piastra per personalizzare il vostro cancello
 NL: u kunt de richting van deze plaat omdraaien en veranderen om uw poort te verpersoonlijken...
 PL: można obrócić i przełączyć kierunek tej płyty, aby spersonalizować bramę.

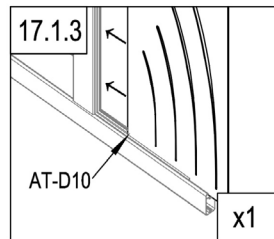
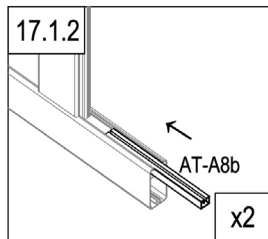
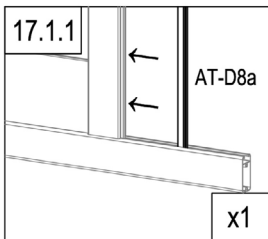

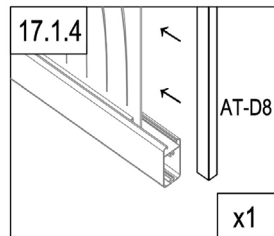

	AT-D8a	1
	AT-A8b	2
	AT-D10	1
	AT-D8	1

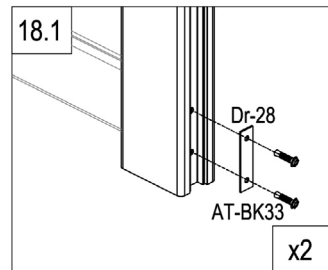
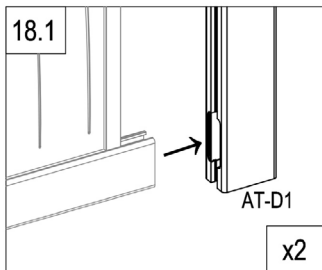
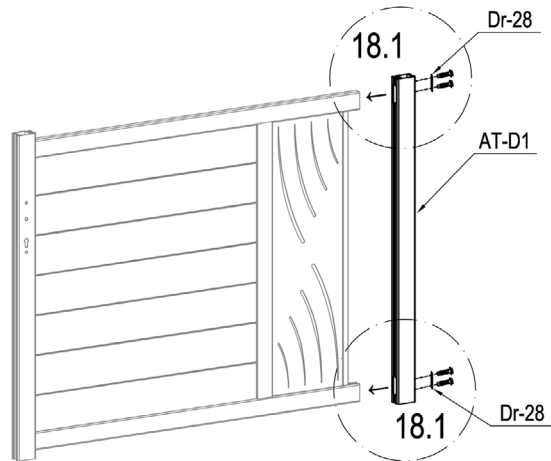

B



	AT-D1	1
	Dr-28	2
	AT-BK33	4

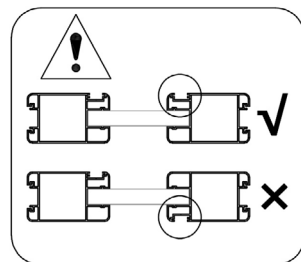

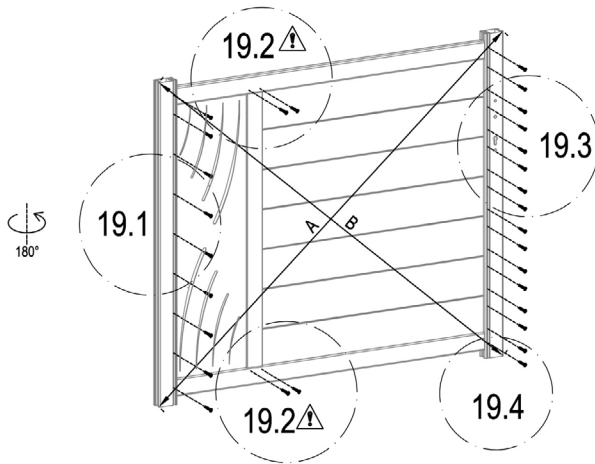

B



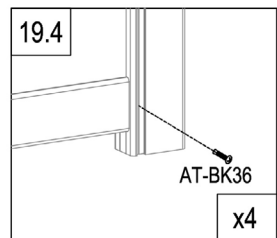
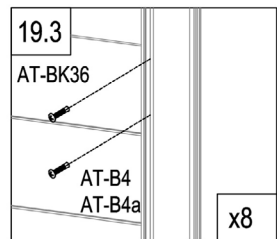
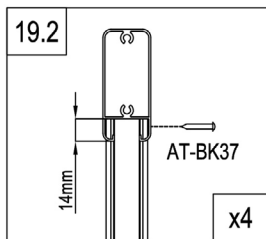
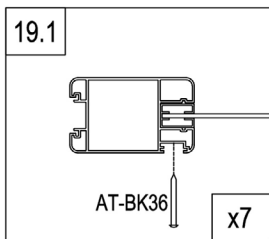

A=B

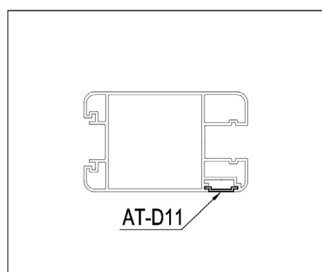
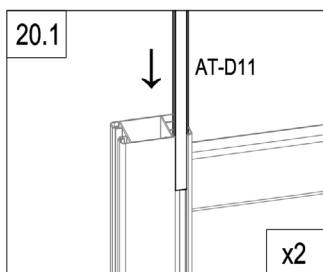
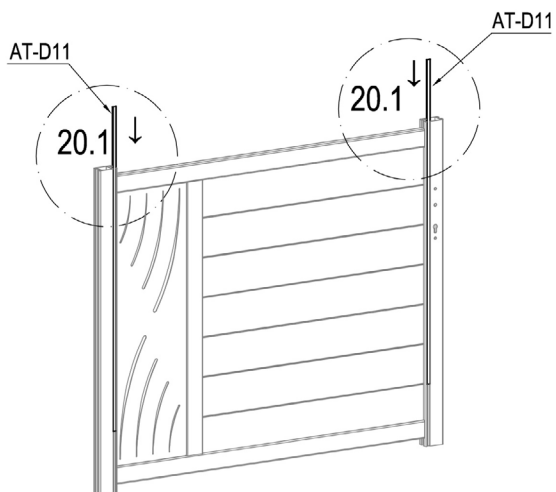

	AT-BK36	28
	AT-BK37	4

B



	AT-D11	2
---	--------	---

B

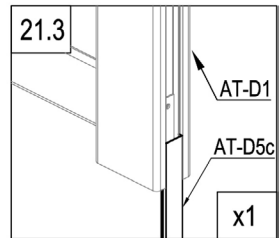
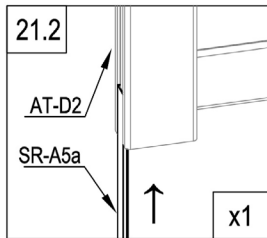
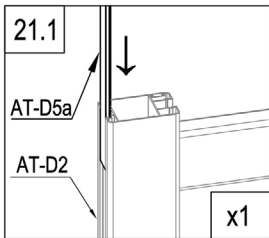
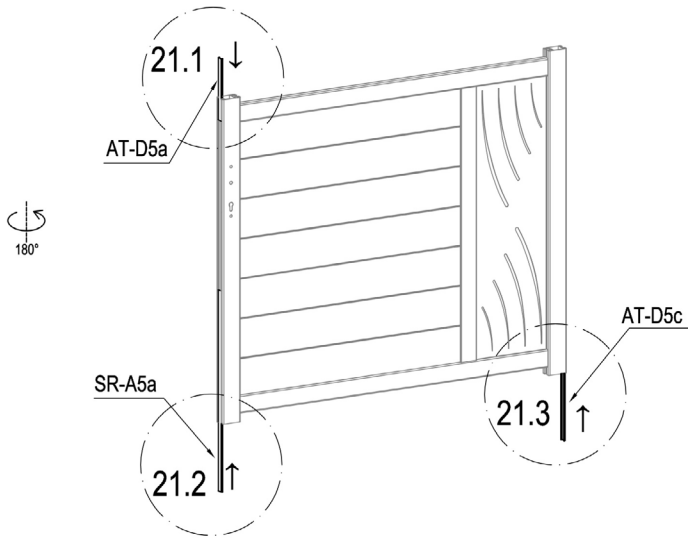

	AT-D5c	1
	AT-D5a	1
	SR-A5a	1

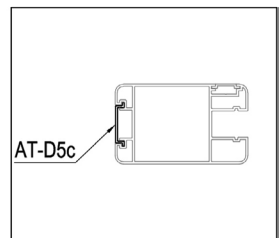

B

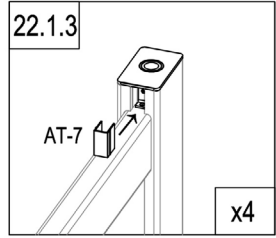
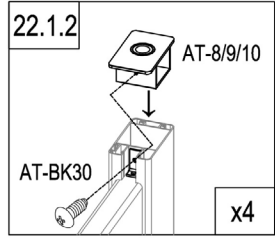
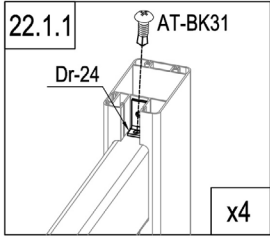
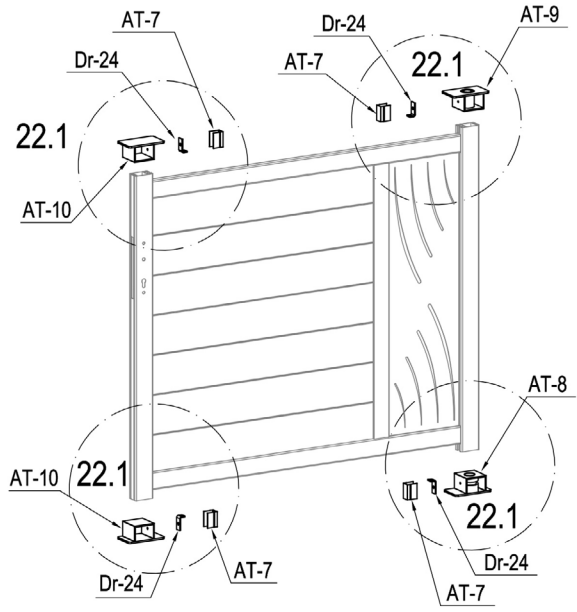

	AT-8	1
	AT-9	1
	AT-10	2
	Dr-24	4

	AT-7	4
	AT-BK30	4
	AT-BK31	4

B

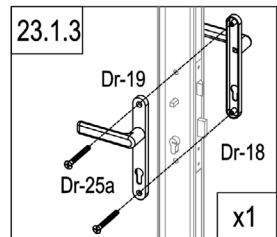
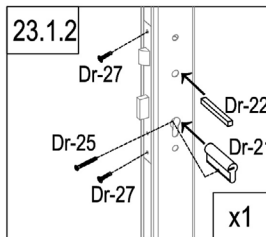
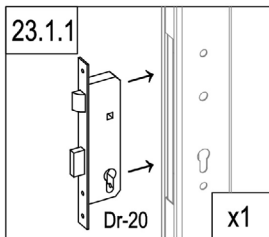
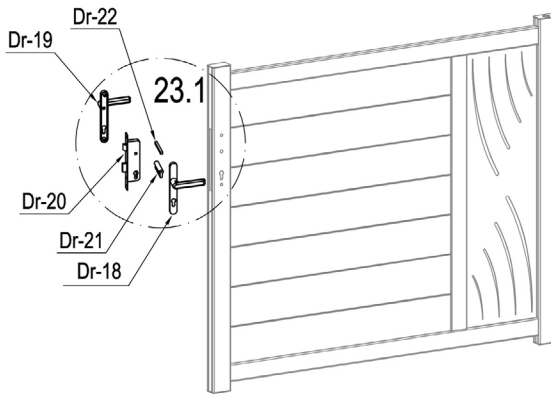

	Dr-20	1
	Dr-21	1
	Dr-22	1
	Dr-25	1

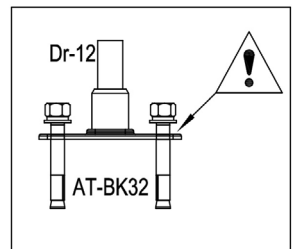
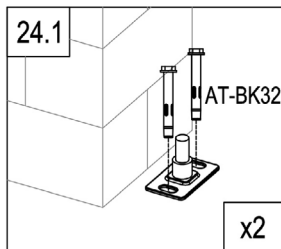
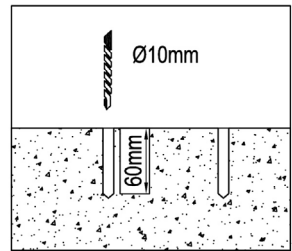
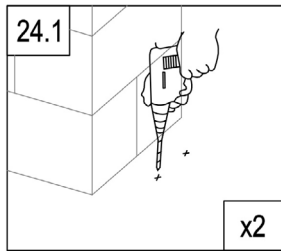
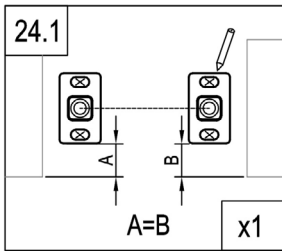
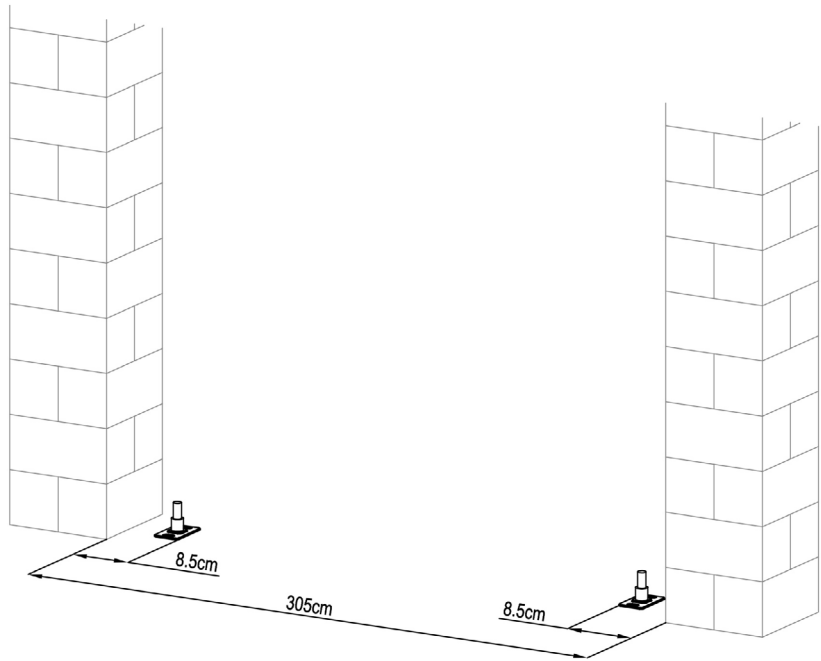

	Dr-18	1
	Dr-19	1
	Dr-25a	2
	Dr-27	2



	Dr-12	2
	AT-BK32	4

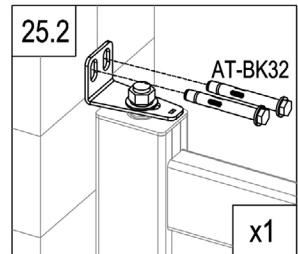
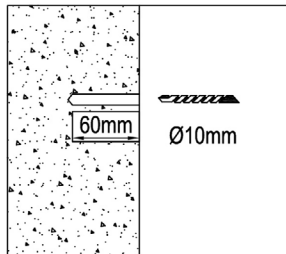
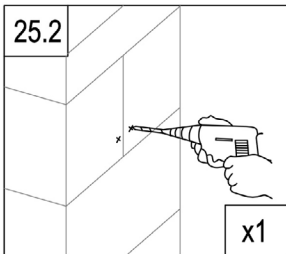
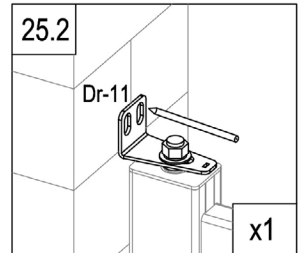
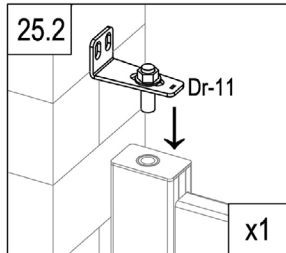
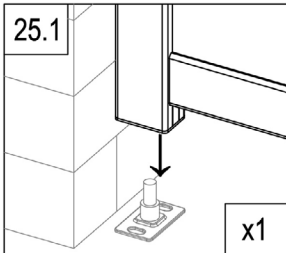
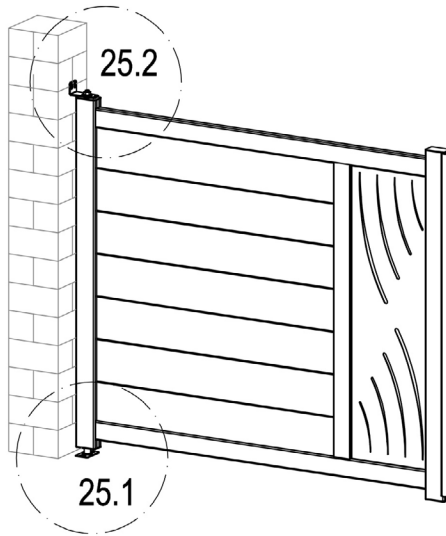

CASANOVO



	Dr-11	1
	AT-BK32	2

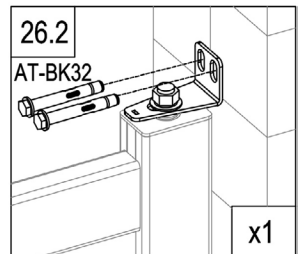
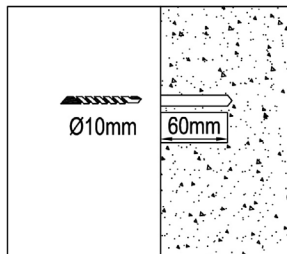
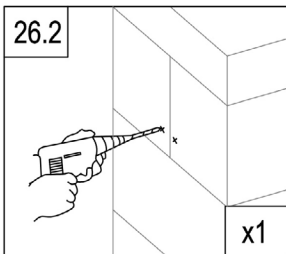
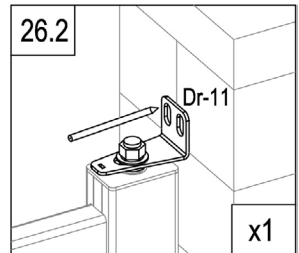
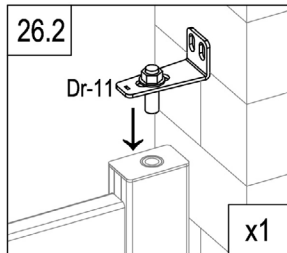
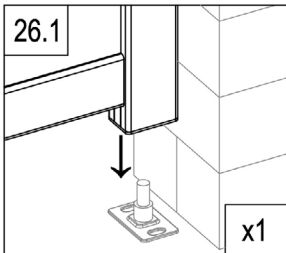
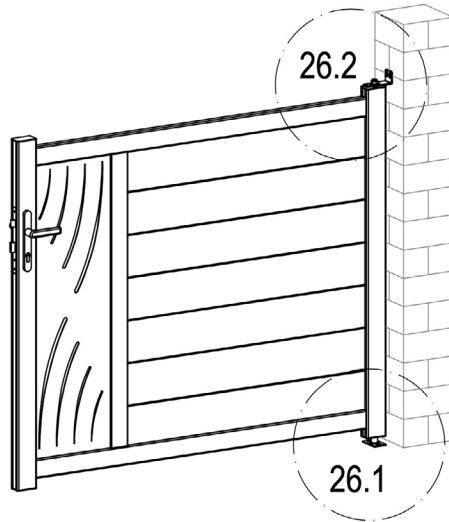

CASANOVO



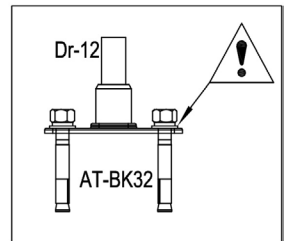
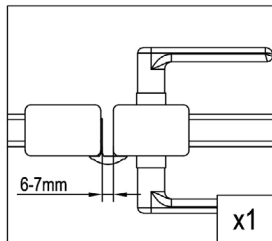
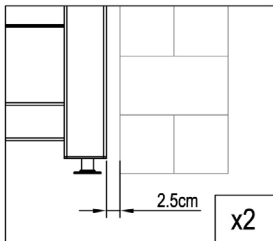
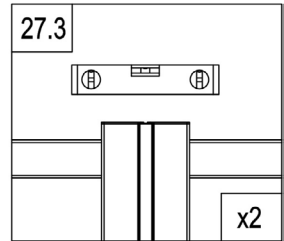
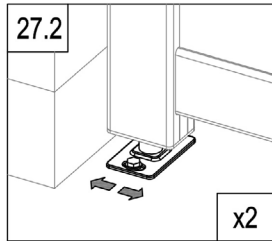
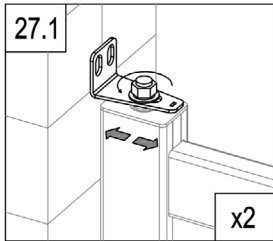
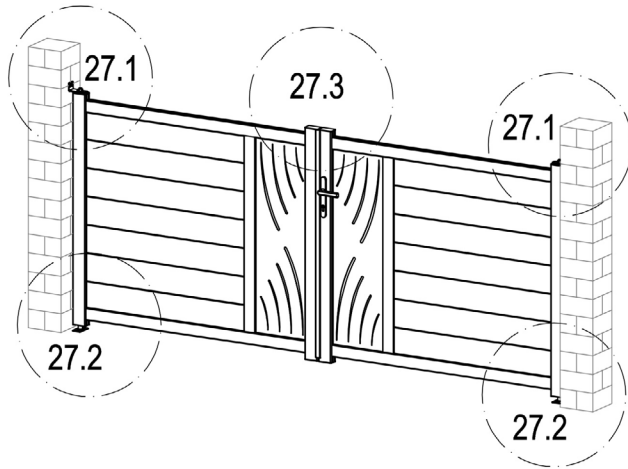
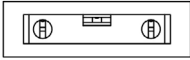

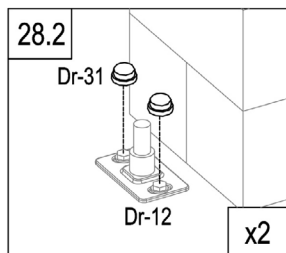
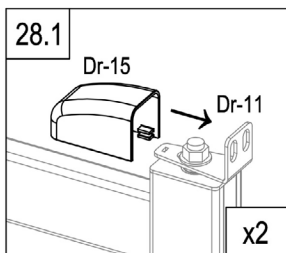
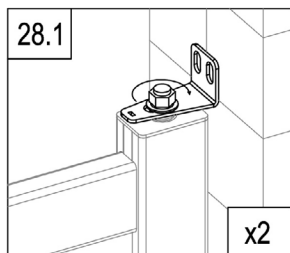
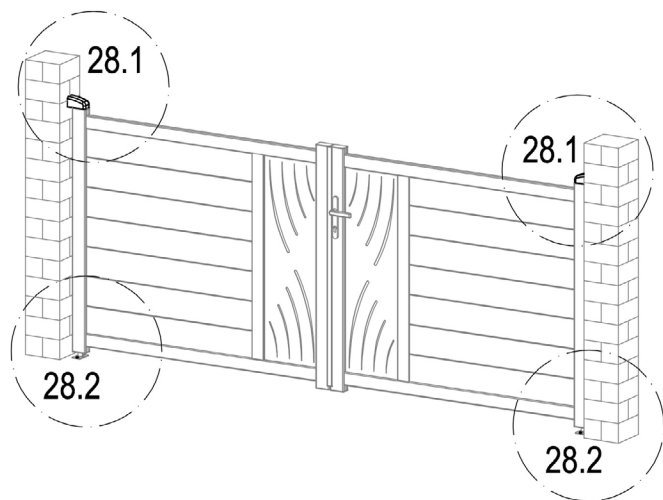

	Dr-11	1
	AT-BK32	2



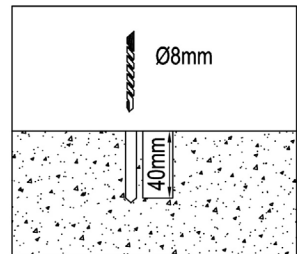
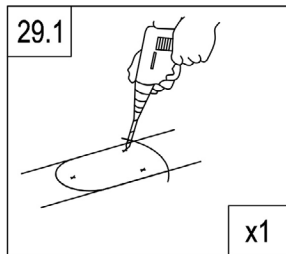
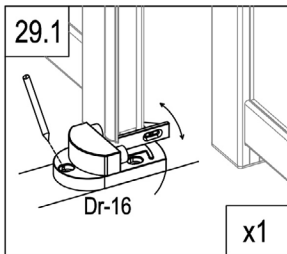
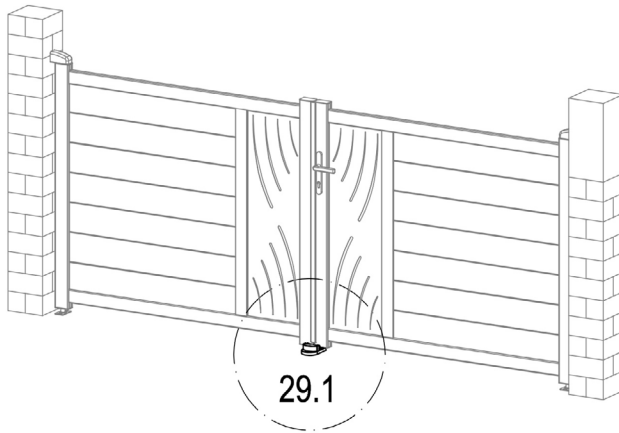



	Dr-15	2
	Dr-31	4

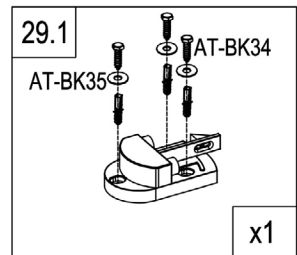

	Dr-16	1
	AT-BK34	3
	AT-BK35	3

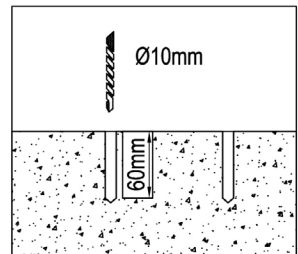
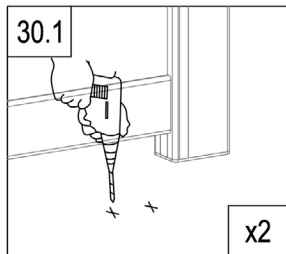
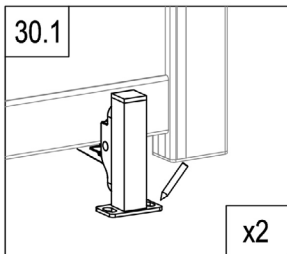
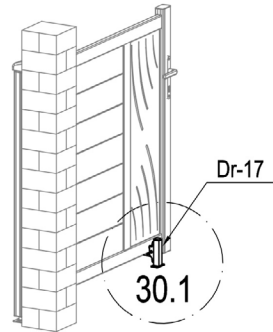
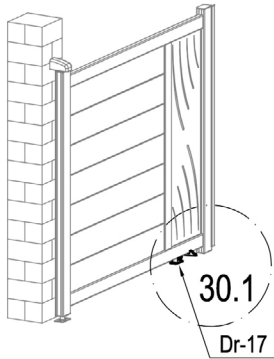



	AT-BK32	4
	Dr-17	2

