

# CASANOVO

## EIGER 600C160

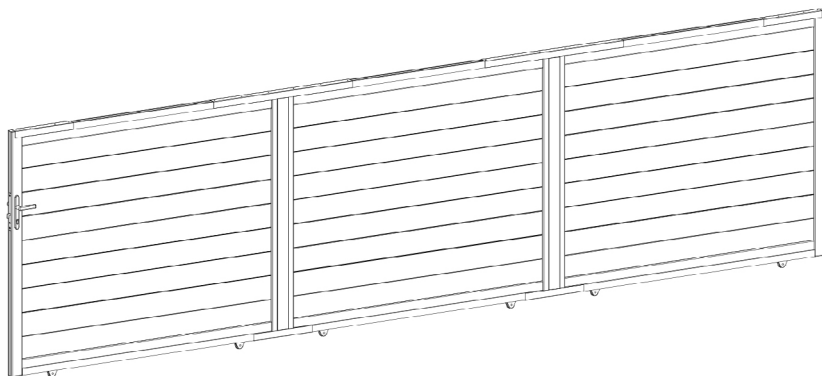

COM-000307 [x1]

COM-000309 [x1]

COM-000311 [x1]

COM-000308 [x1]

COM-000310 [x1]

COM-000785 [x1]



7-8H



X 2



INSTRUCTION MANUAL / NOTICE DE MONTAGE / MONTAGEANLEITUNG / MANUAL DE MONTAJE / MANUAL DE MONTAGEM / MANUALE DI MONTAGGIO /  
MONTAGEHANDLEIDING / INSTRUKCJA MONTAŻU / KÄYTTÖOHJEET / BRUKSANVISNING / BRUGSANVISNING / INSTRUCIUNI DE ASAMBLARE /  
NAVODILA ZA SESTAVLJANJE / NÁVOD NA MONTÁŽ / ÖSSZESZERELÉSI ÚTMUTATÓ / NÁVOD K MONTÁŽI / UPUTE ZA INSTALACIJU /  
ΟΔΗΓΙΕΣ ΣΥΝΑΡΜΟΛΟΓΗΣΗΣ / SURINKIMO INSTRUKCIJOS / MONTĀŽAS INSTRUKCIJAS

## Ext.

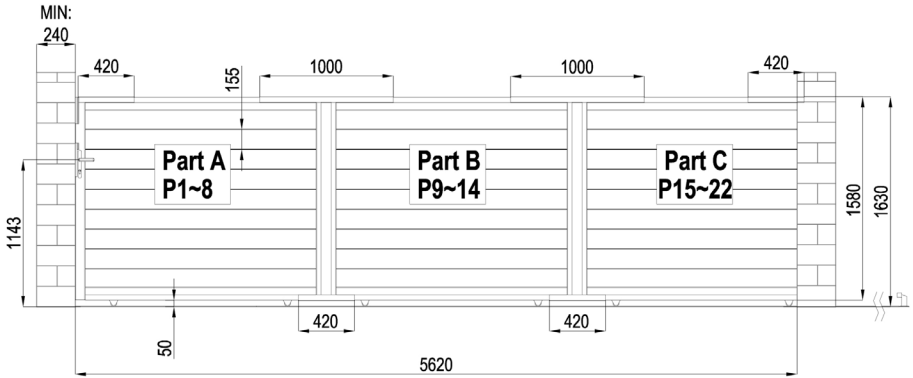

## Int.

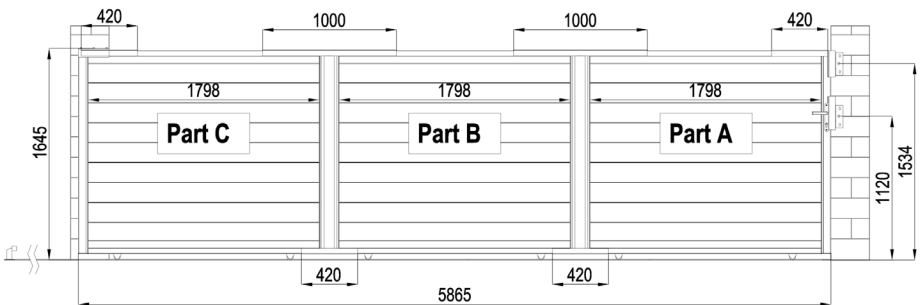

## Part A.

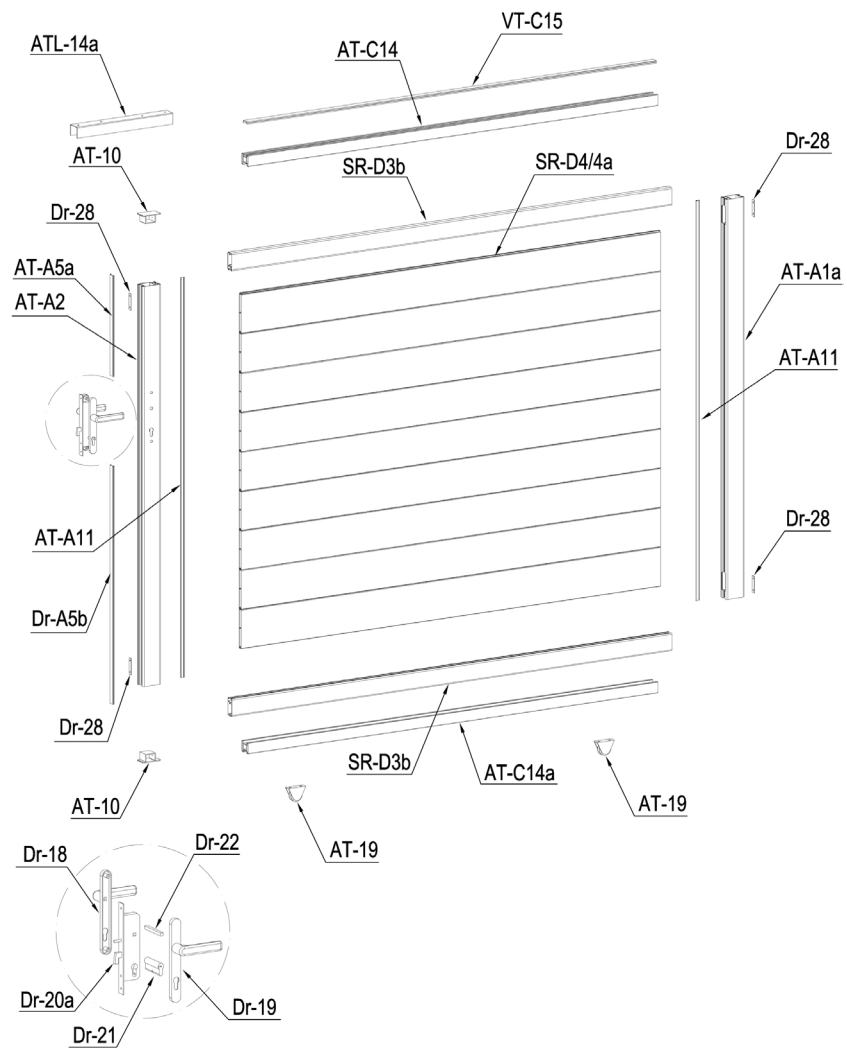

## Part B.

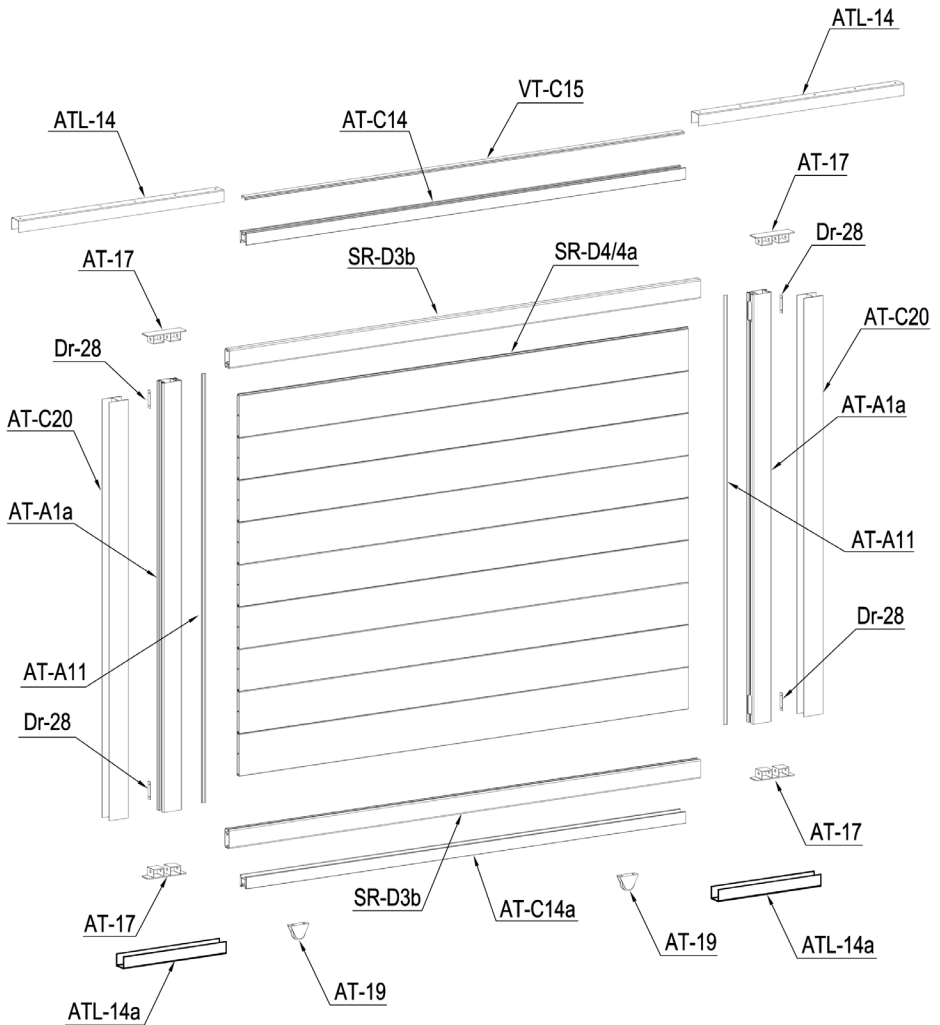



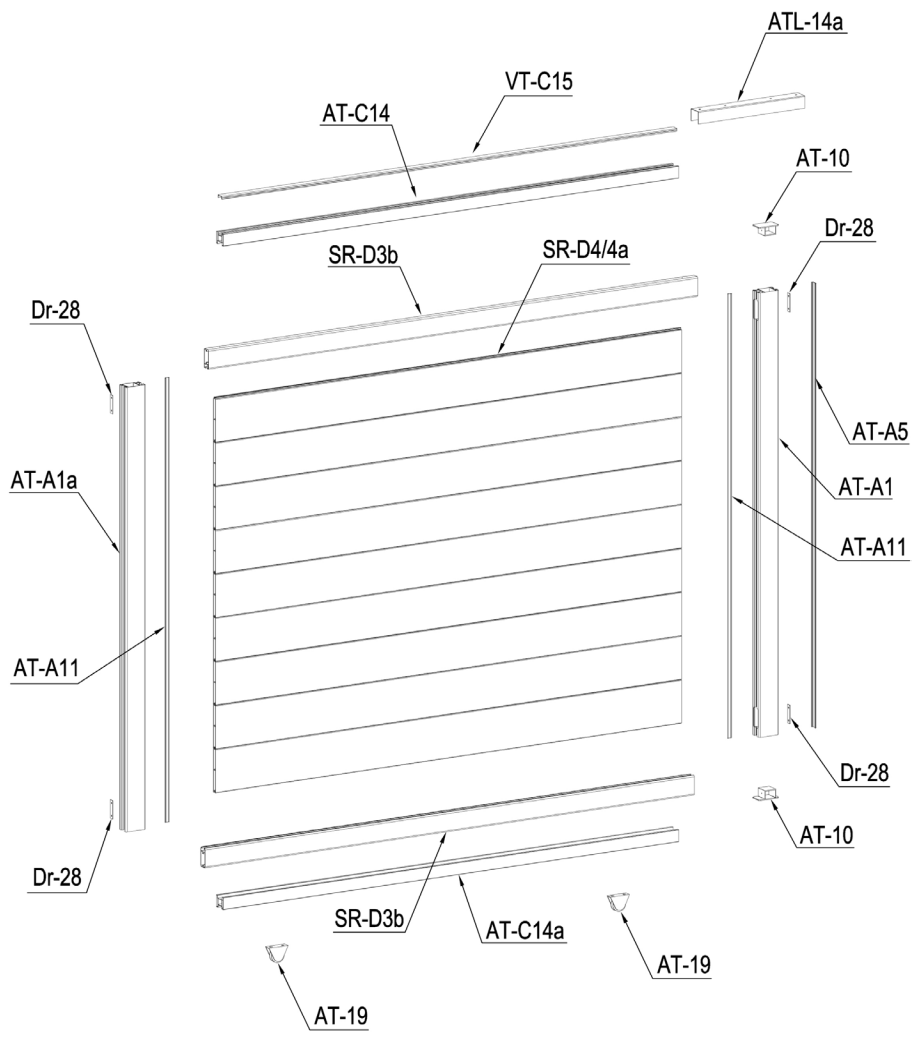

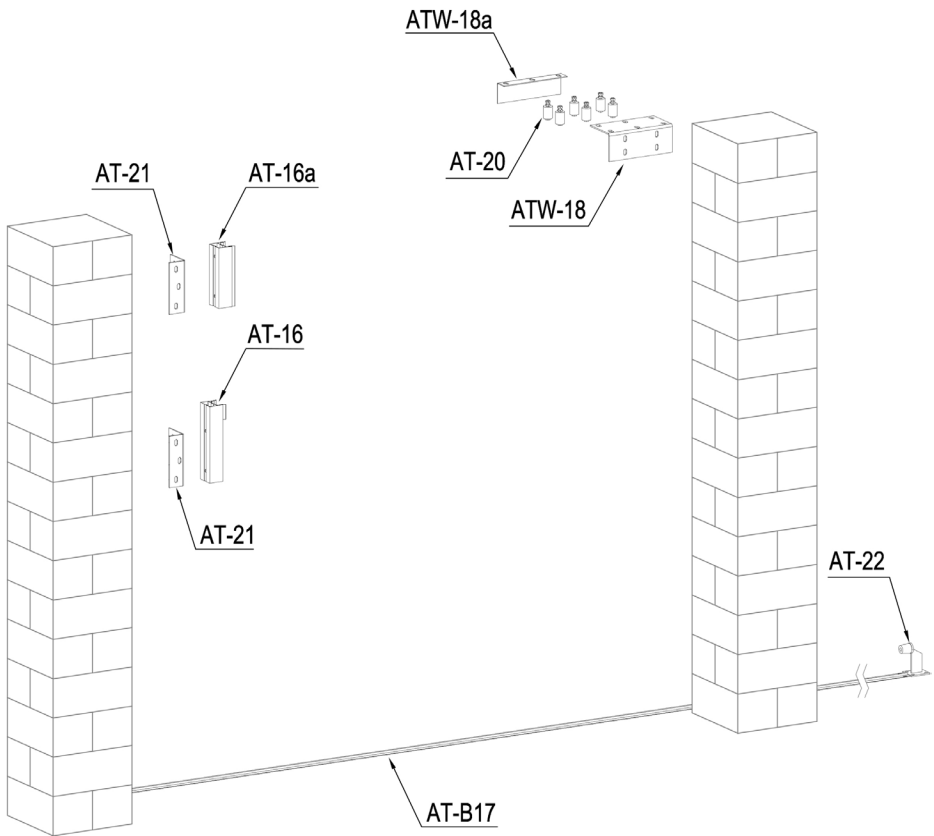

































## Part C.







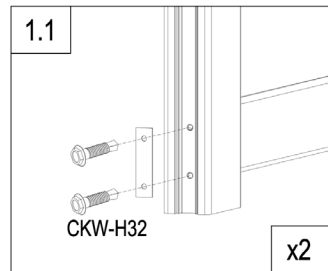
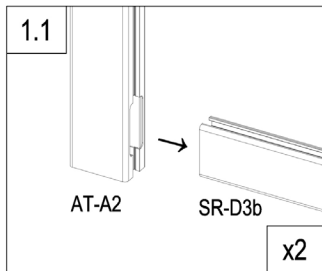
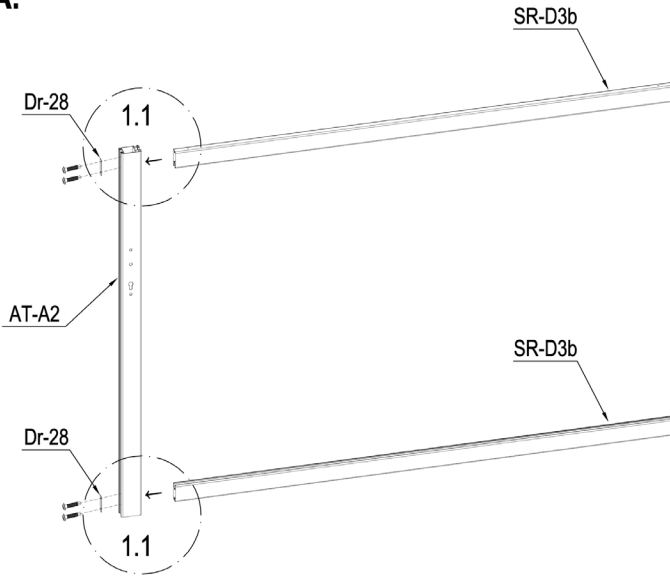

## PART LIST

IMAGE	NO.	L.(mm)	QTY	IMAGE	NO.	L.(mm)	QTY
	AT-A1a	1573	4		AT-22		1
	AT-A1	1573	1		Dr-18		1
	AT-A2	1573	1		Dr-19		1
	SR-D3b	1931	6		Dr-20a		1
	SR-D4	1840	24		Dr-21		1
	SR-D4a	1840	3		Dr-22		1
	AT-A5	1573	1		Dr-25		1
	AT-A5a	395.5	1		Dr-25a		2
	Dr-A5b	937	1		Dr-27		2
	AT-A11	1573	6		CKW-H30		4
	AT-C20	1493	2		CKW-H31		14
	AT-C14	1798	3		CKW-H32		48
	AT-C14a	1798	3		CKW-H33		4
	VT-C15	1797	3		CKW-H34		138
	AT-16	260	1		CKW-H36		4
	AT-16a	205	1		CKW-H37		12
	AT-B17	1412	8		CKW-H38		80
	ATL-14	1000	2		Dr-28		12
	ATL-14a	420	4		ATW-22J		10
	AT-17		4				
	AT-10		4				
	ATW-18		1				
	ATW-18a		1				
	AT-19		6				
	AT-20		6				
	AT-21		2				

## Part A.



	AT-A2	1
	SR-D3b	2
	Dr-28	2
	CKW-H32	4



## Part A.

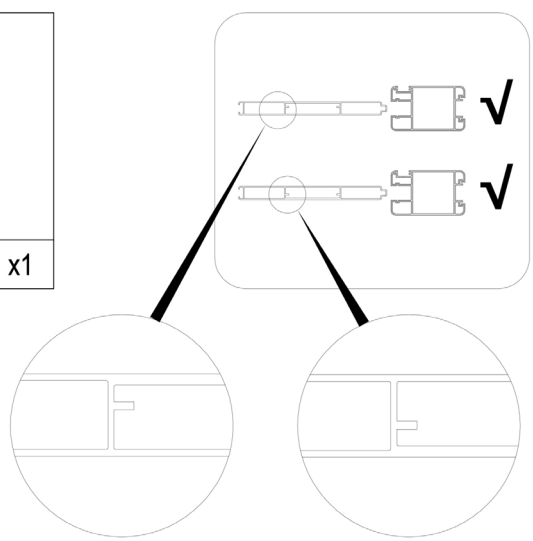
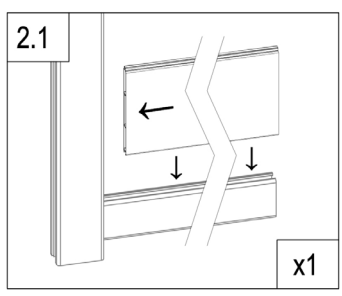
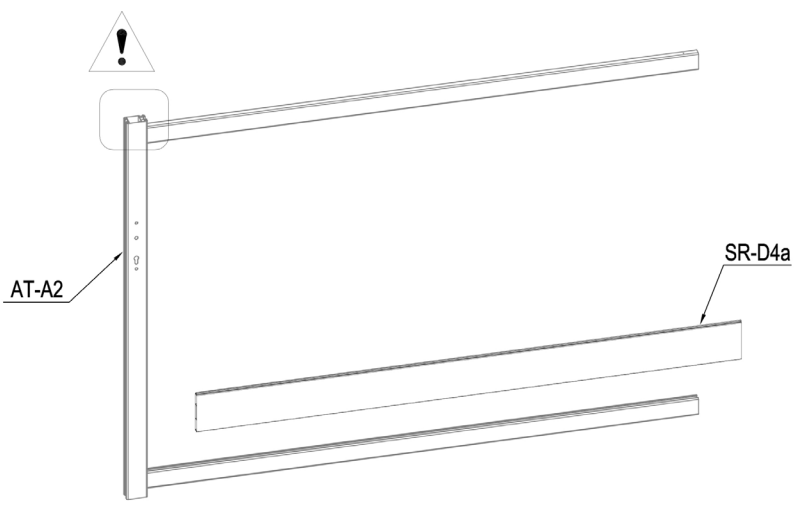

	SR-D4a	1
--	--------	---

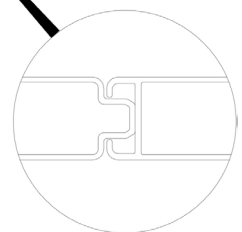
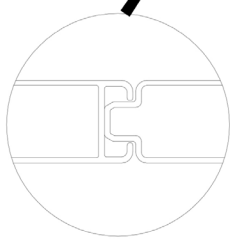
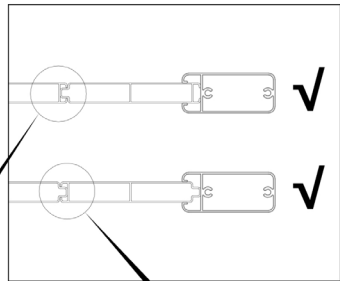
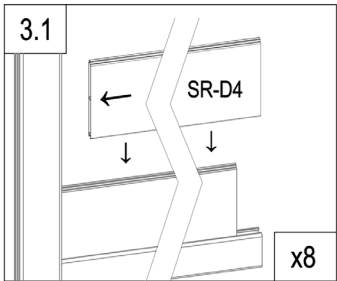
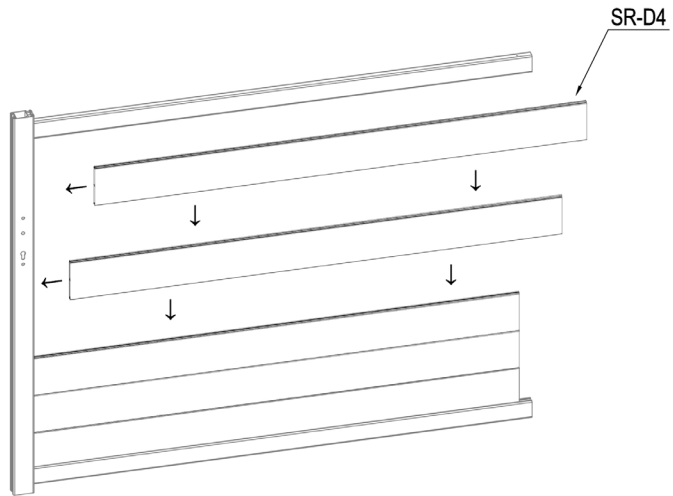

## Part A.

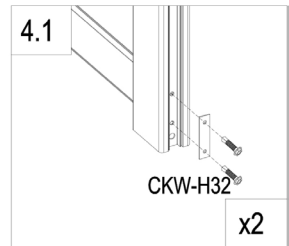
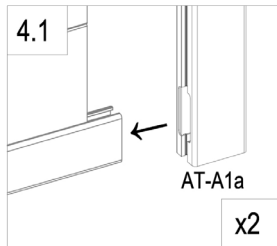
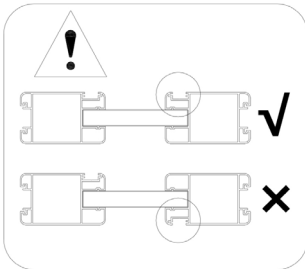
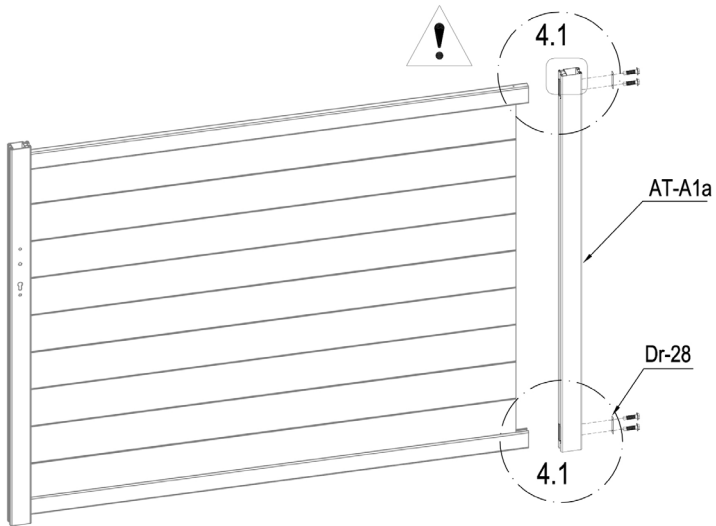

	SR-D4	8
---	-------	---

## Part A.



	AT-A1a	1
	Dr-28	2
	CKW-H32	4

## Part A.

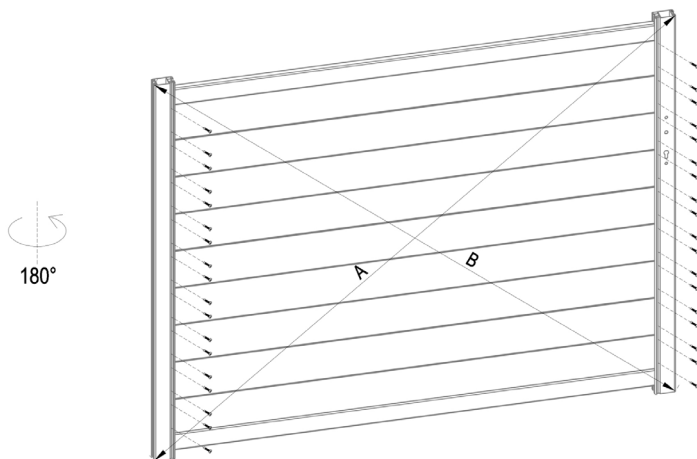

A=B

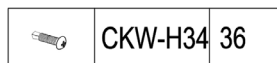
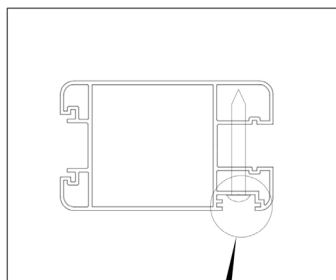
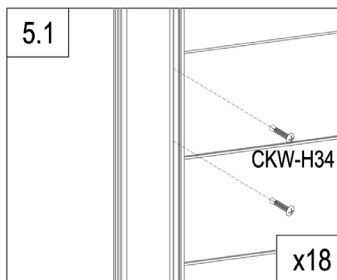

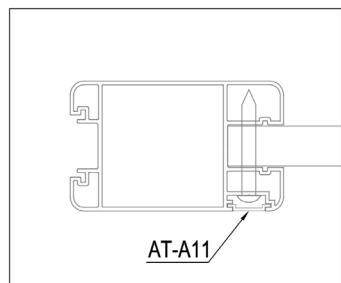
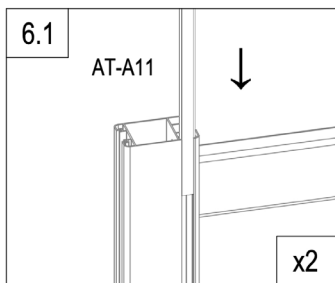
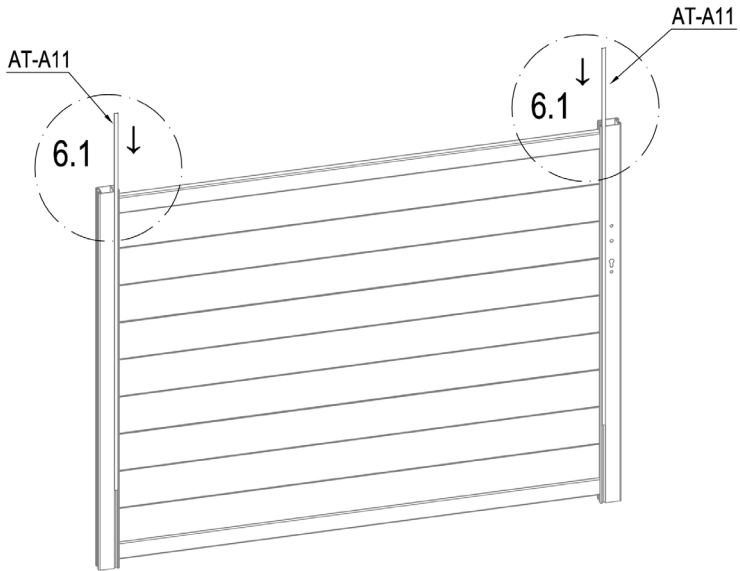

## Part A.



	AT-A11	2
---	--------	---

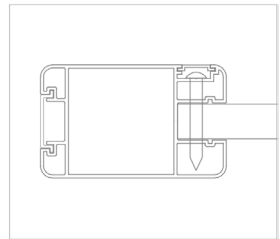
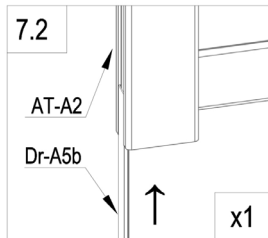
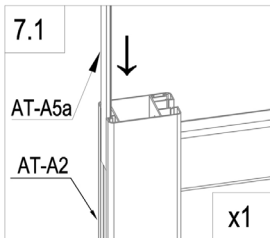
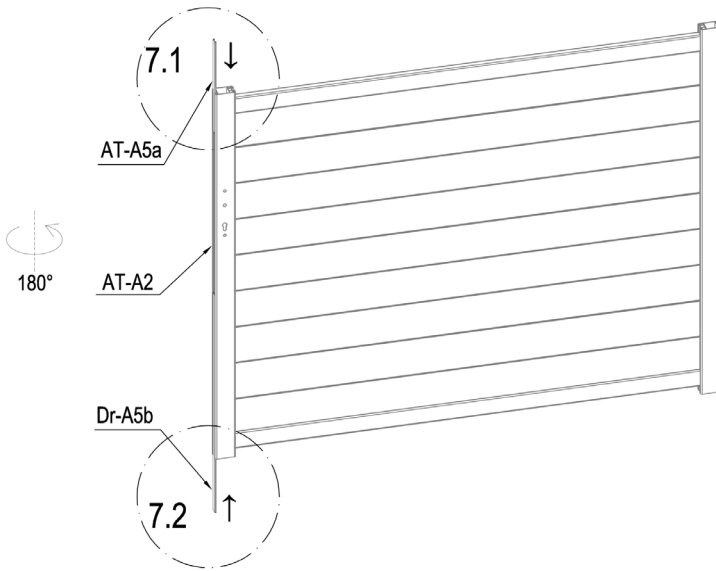

## Part A.



	AT-A5a	1
	Dr-A5b	1

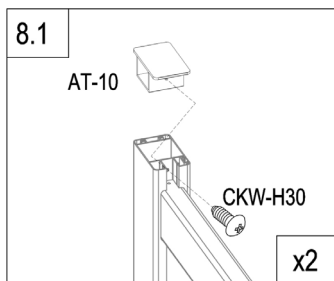
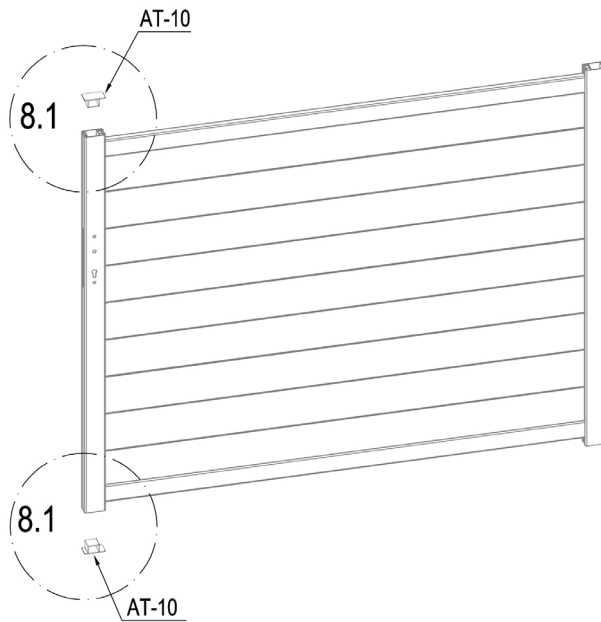



## Part A.

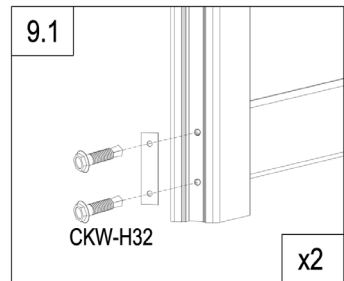
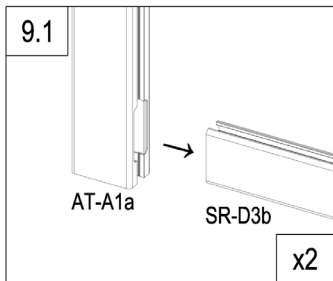
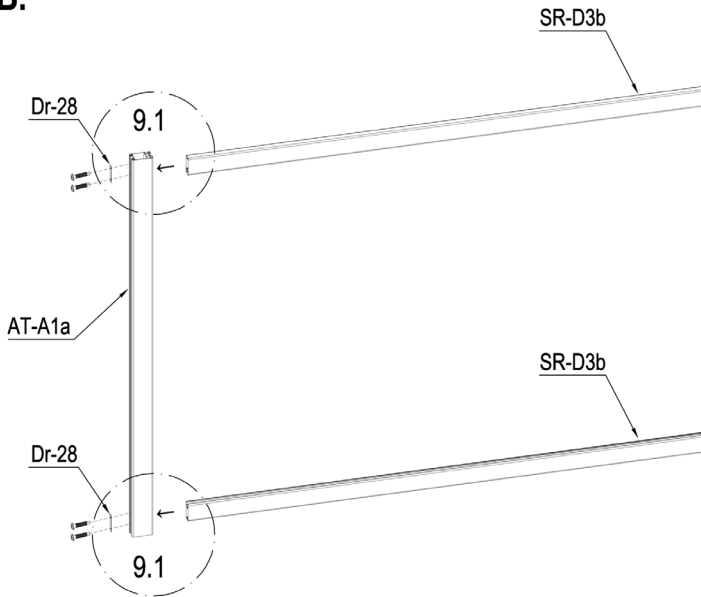

	AT-10	2
	CKW-H30	2

## Part B.



	AT-A1a	1
	SR-D3b	2
	Dr-28	2
	CKW-H32	4



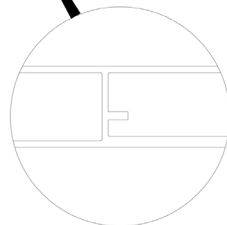
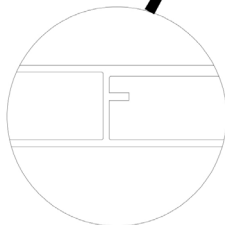
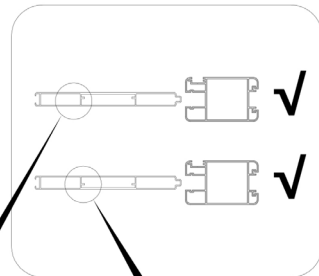
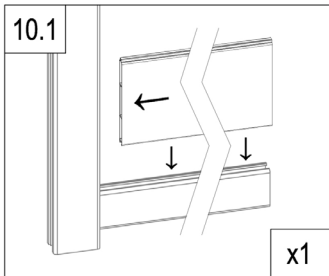
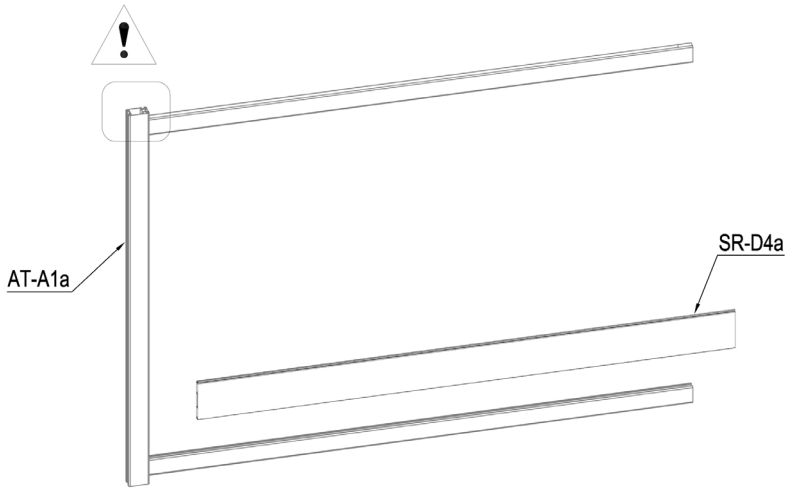

## Part B.

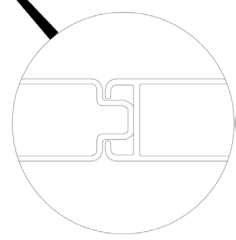
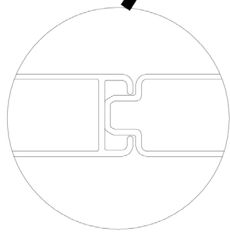
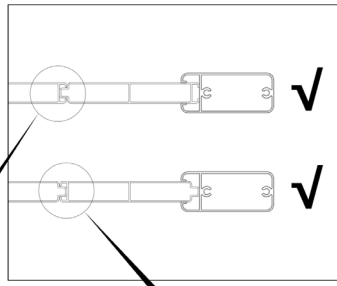
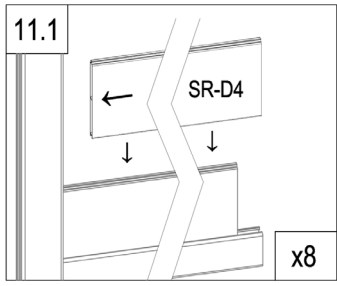
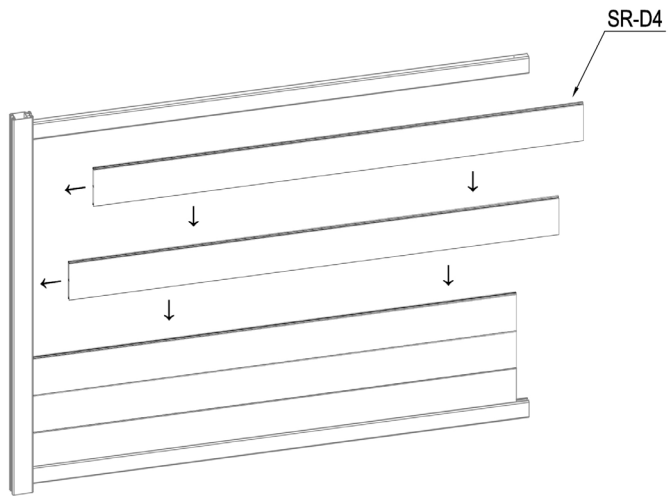

	SR-D4a	1
---	--------	---

## Part B.



	SR-D4	8
---	-------	---

## Part B.

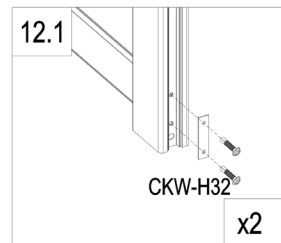
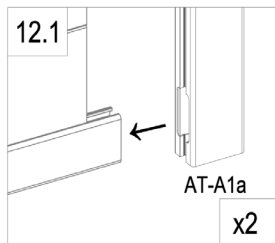
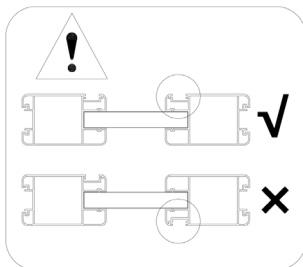
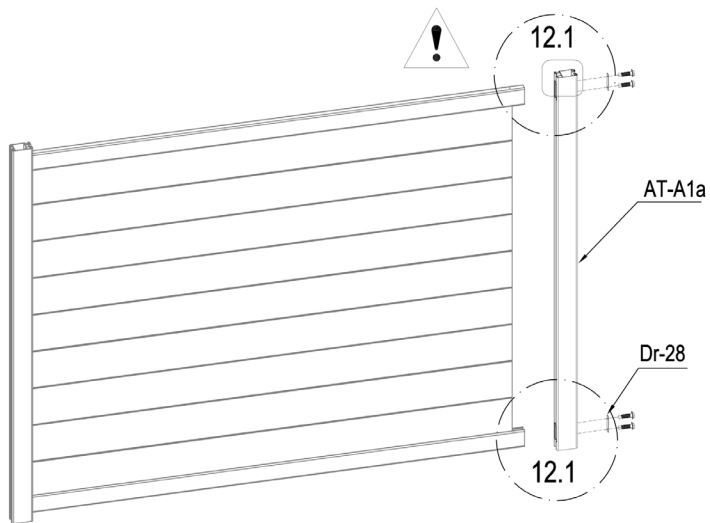

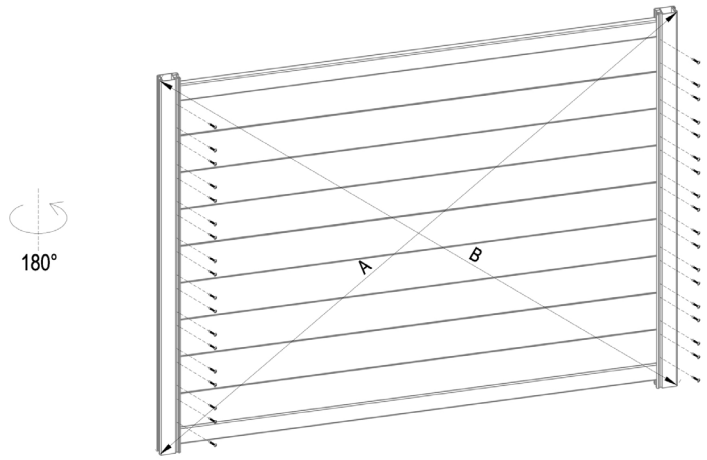

	AT-A1a	1
	Dr-28	2
	CKW-H32	4

## Part B.



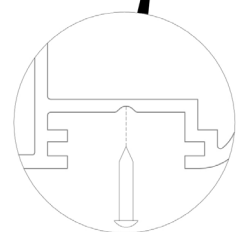
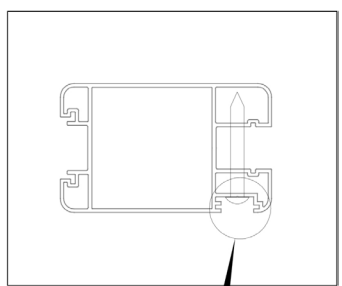
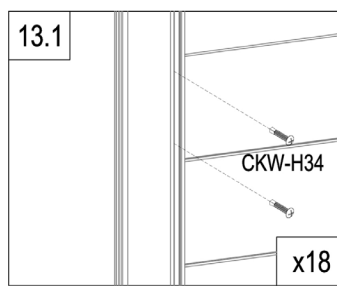

A=B



	CKW-H34	36
---	---------	----

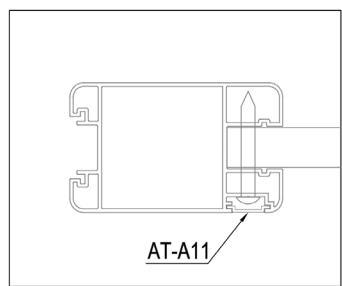
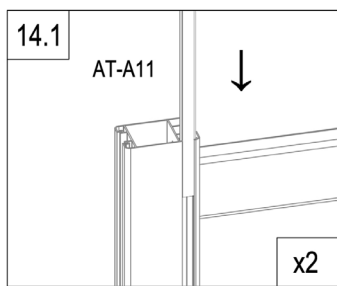
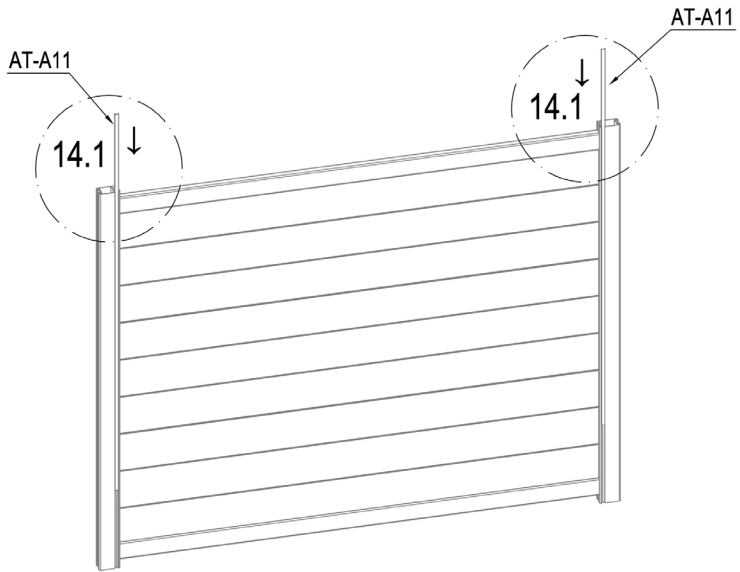



## Part B.

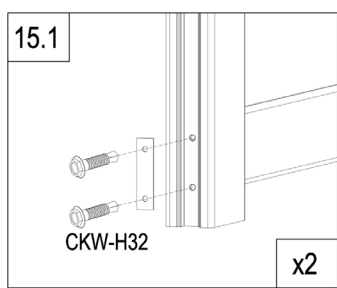
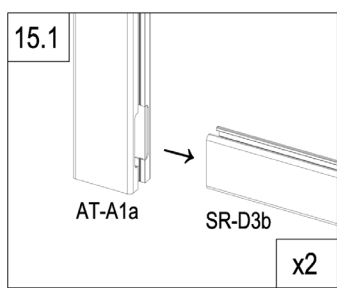
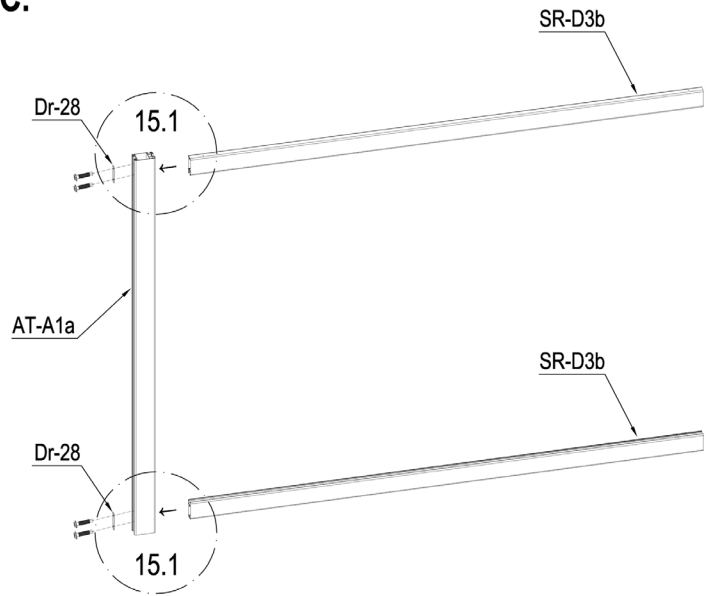

	AT-A11	2
---	--------	---

## Part C.



	AT-A1a	1
	SR-D3b	2
	Dr-28	2
	CKW-H32	4

## Part C.

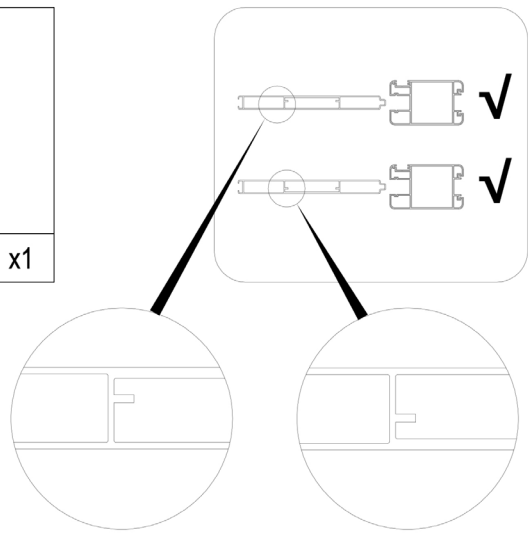
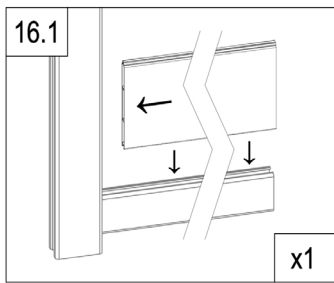
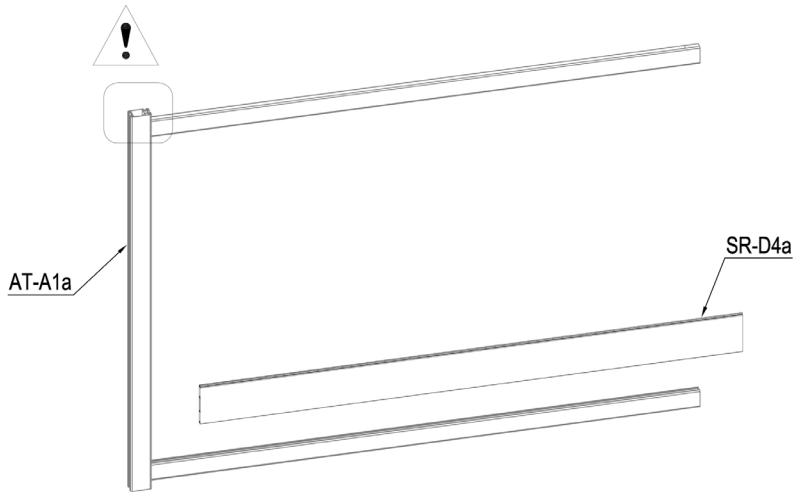

	SR-D4a	1
--	--------	---

## Part C.

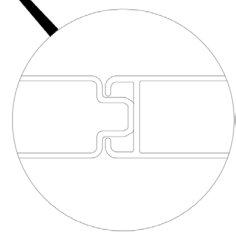
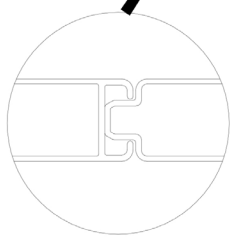
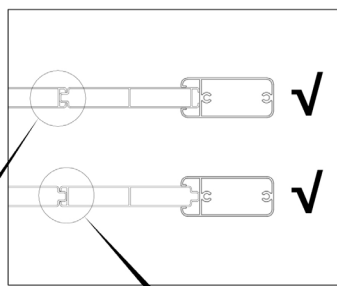
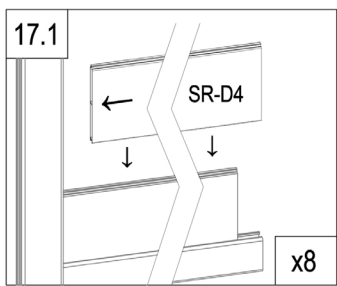
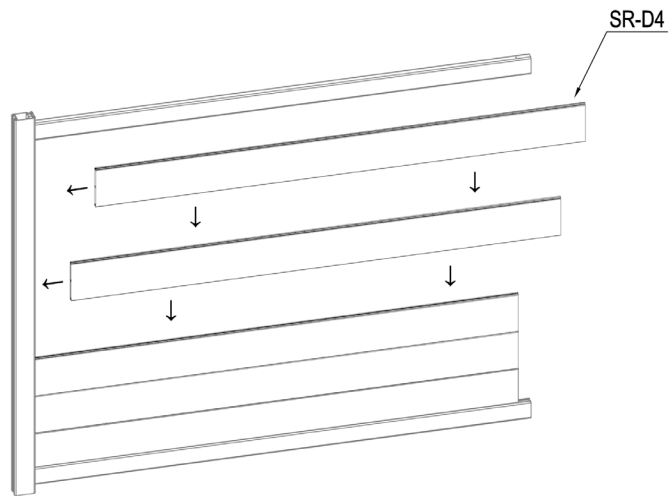

	SR-D4	8
---	-------	---



## Part C.

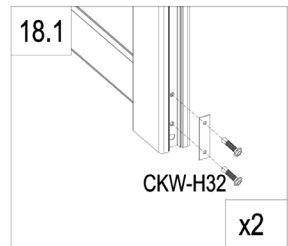
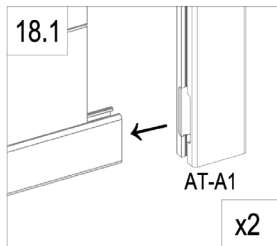
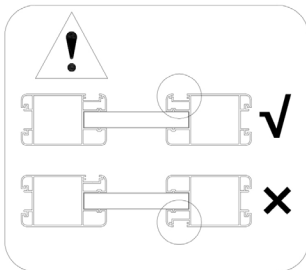
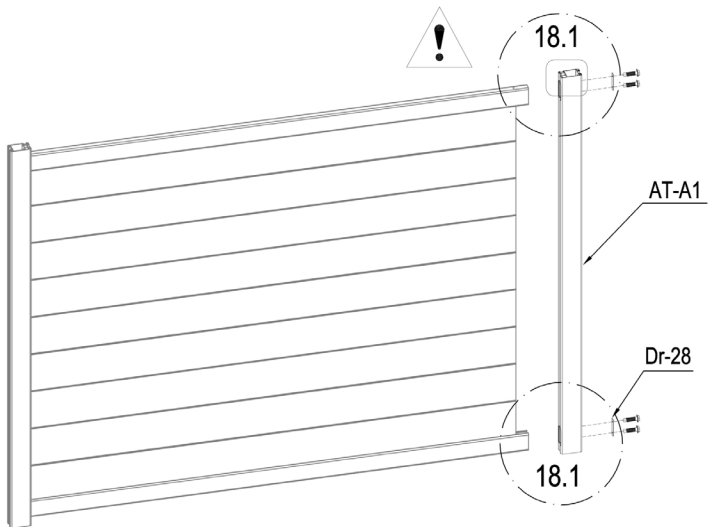

	AT-A1	1
	Dr-28	2
	CKW-H32	4

## Part C.

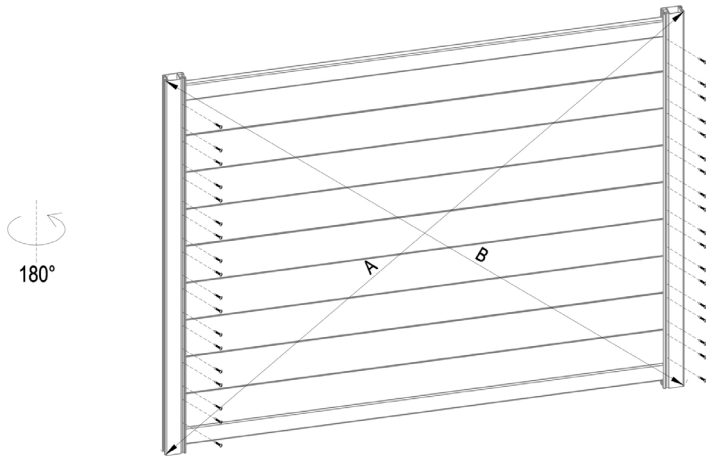

A=B

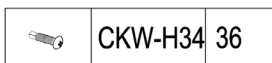
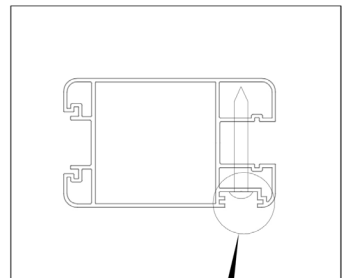
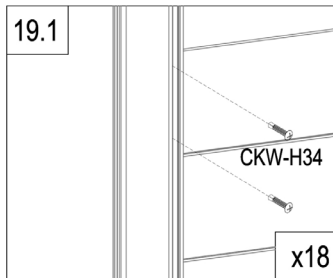

## Part C.

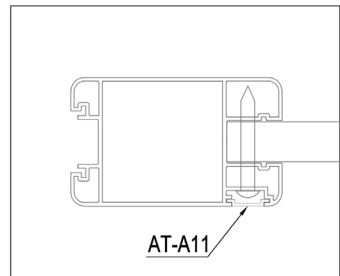
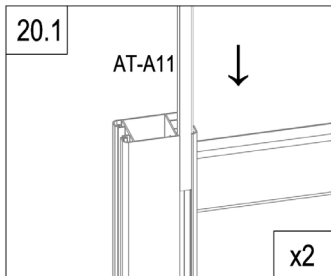
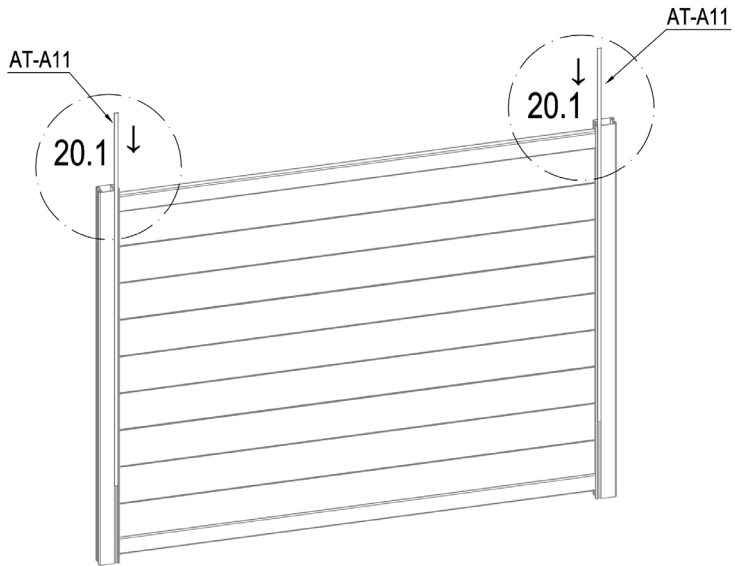

	AT-A11	2
---	--------	---

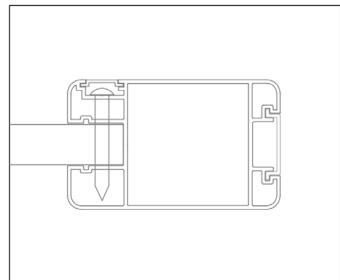
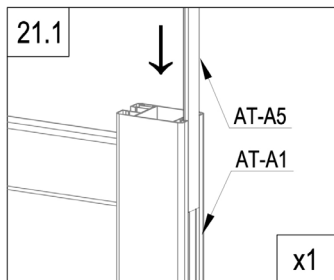
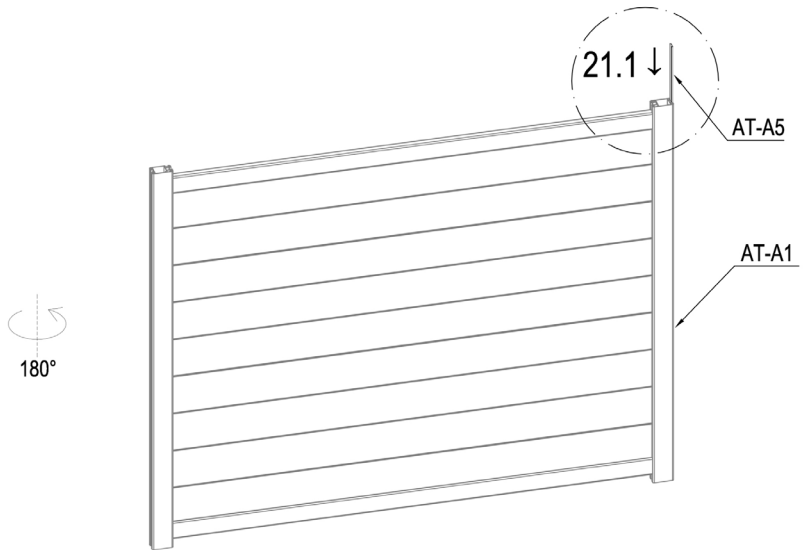

## Part C.





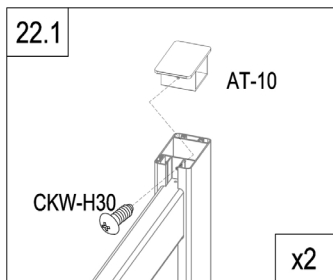
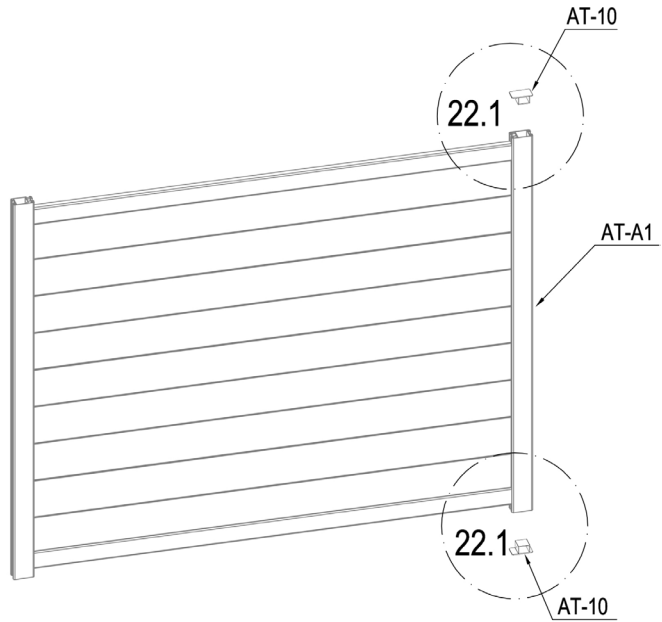

]	AT-A5	1
---	-------	---

## Part C.

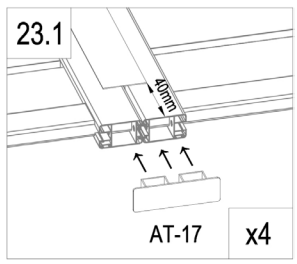
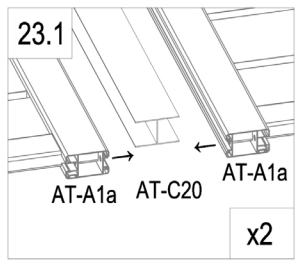
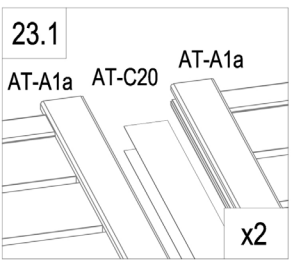
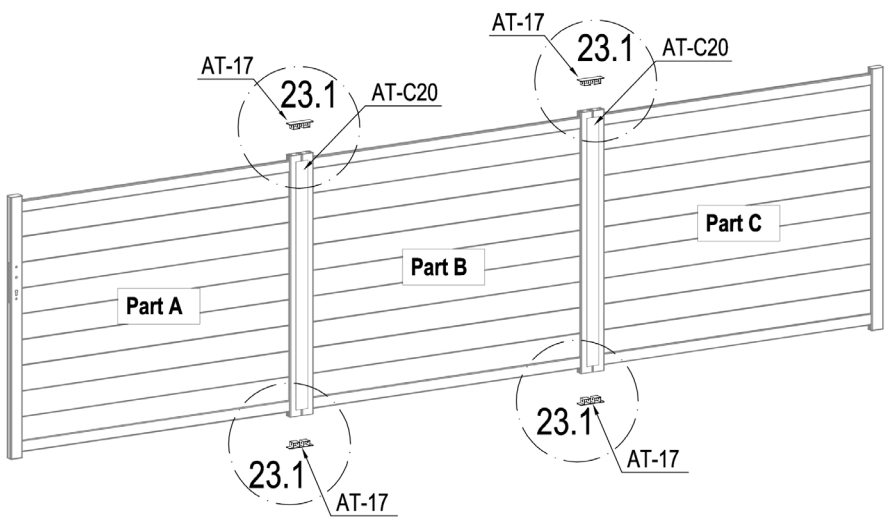

	AT-10	2
	CKW-H30	2



	AT-C20	2
	AT-17	4
	CKW-H33	4

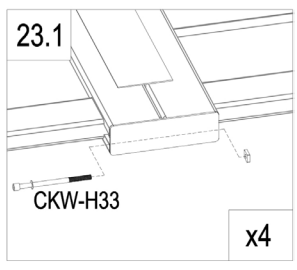

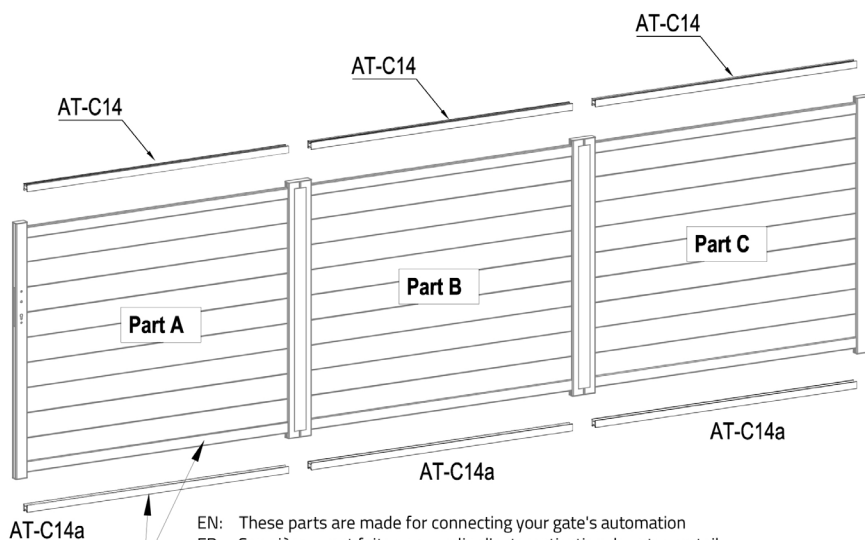

EN: These parts are made for connecting your gate's automation  
 FR: Ces pièces sont faites pour relier l'automatisation de votre portail  
 DE: Diese Teile sind für den Anschluss der Automatisierung Ihres Tores vorgesehen  
 ES: Estas piezas están hechas para conectar la automatización de su puerta  
 PT: Estas peças são feitas para ligar a automatização do seu portão  
 IT: Queste parti sono realizzate per collegare l'automazione del vostro cancello  
 NL: Deze onderdelen zijn gemaakt voor het aansluiten van de automatisering van uw poort.  
 PL: Te części są wykonane do podłączenia automatyki bramy.

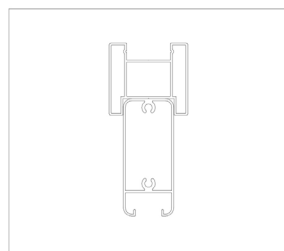
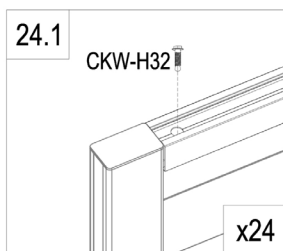
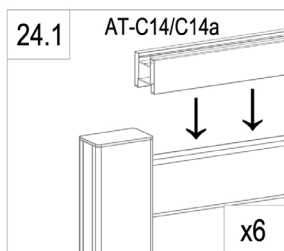

	AT-C14	3
	AT-C14a	3
	CKW-H32	24

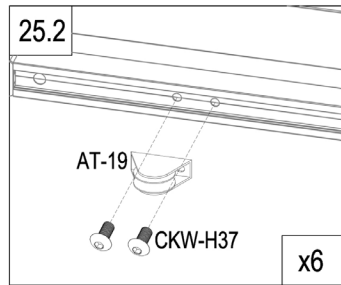
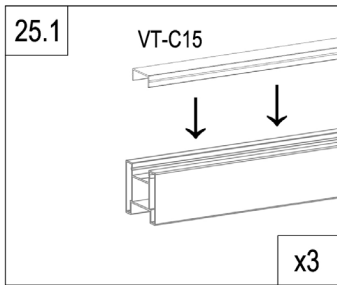
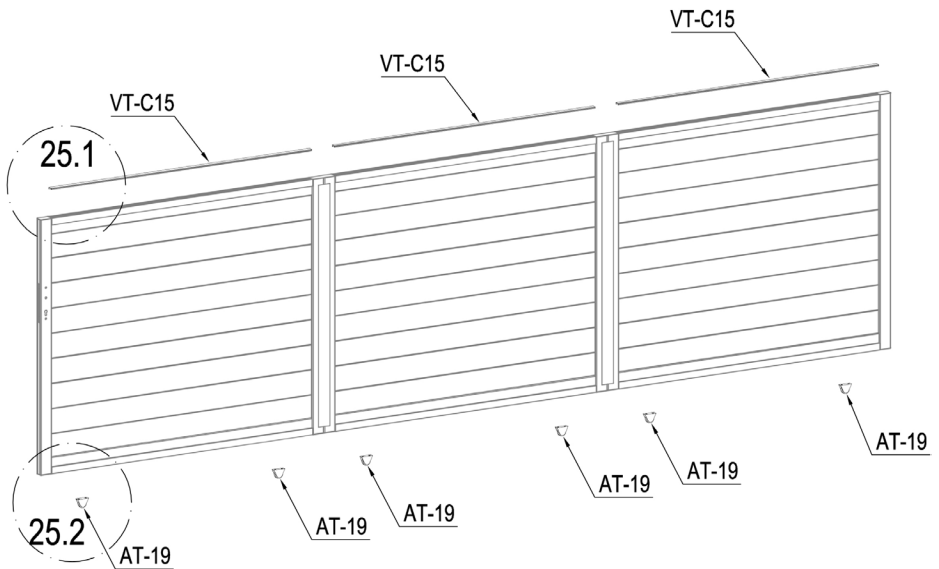

	VT-C15	3
	AT-19	6
	CKW-H37	12



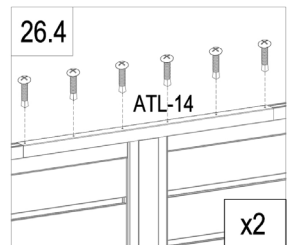
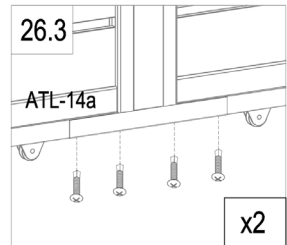
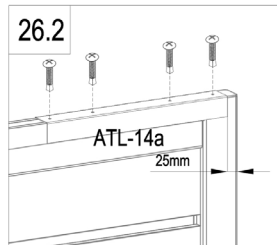
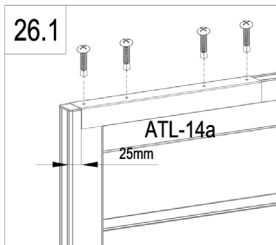
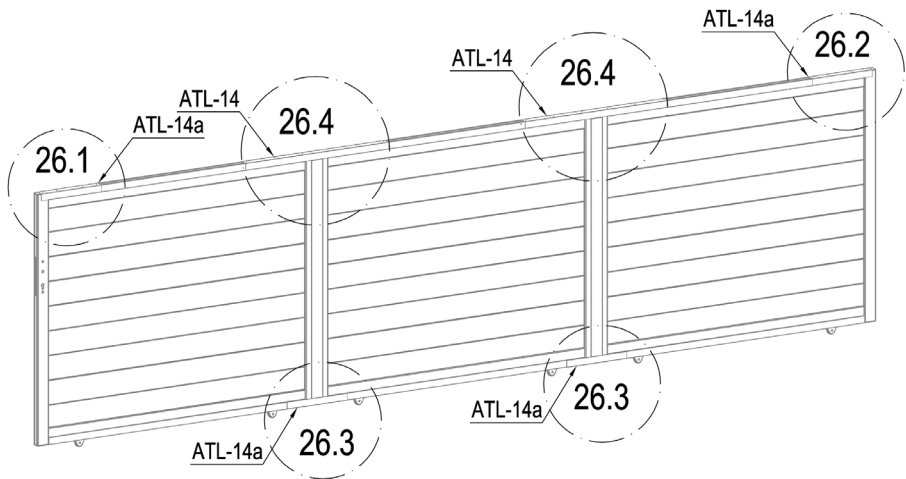

	ATL-14	2
	ATL-14a	4
	CKW-H34	28

**Ext.**

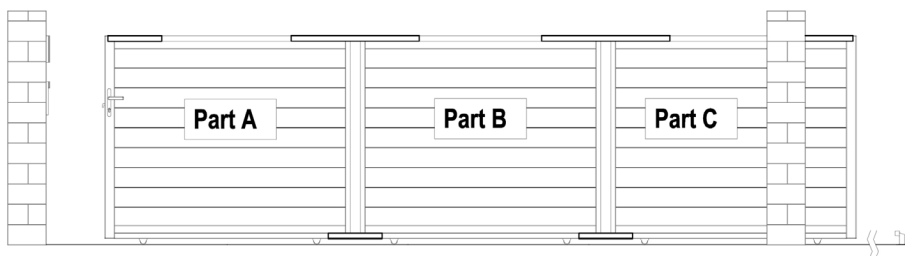

**Int.**

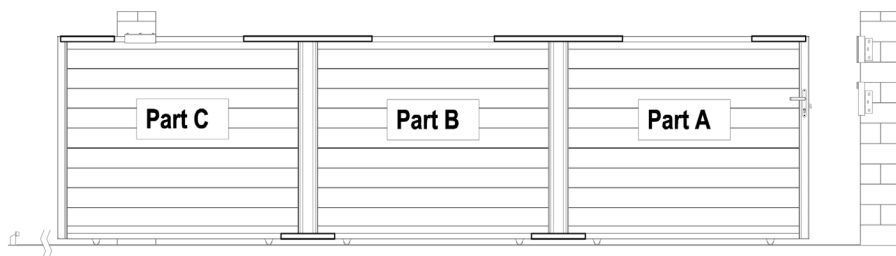

**L** : P27~33

Ext.

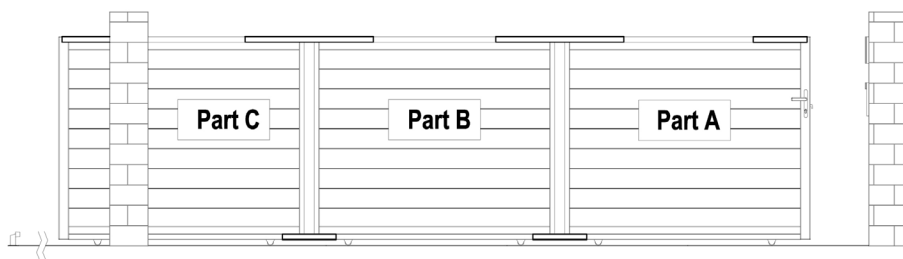

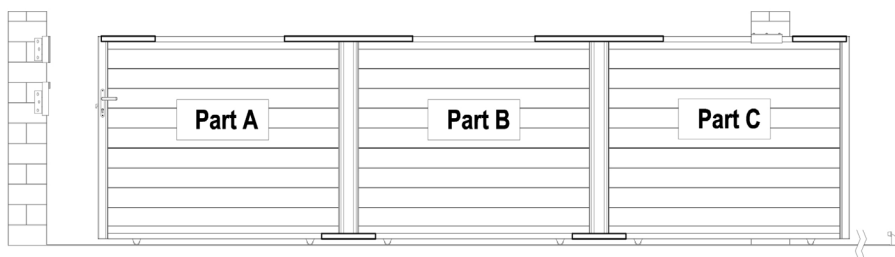

Int.

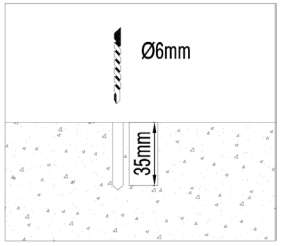
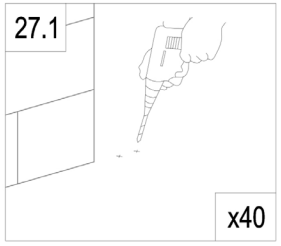
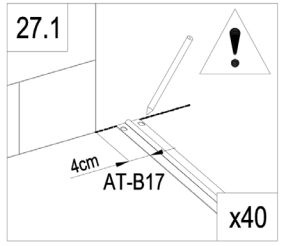
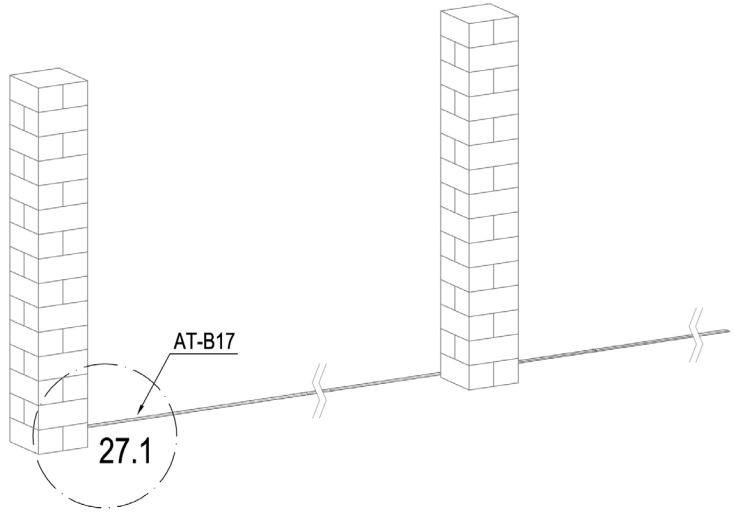

**R** : P34-40

L



	AT-B17	8
	CKW-H38	80

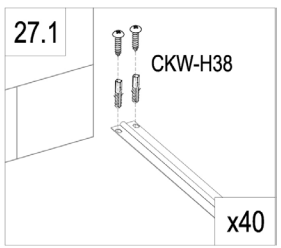

**L**

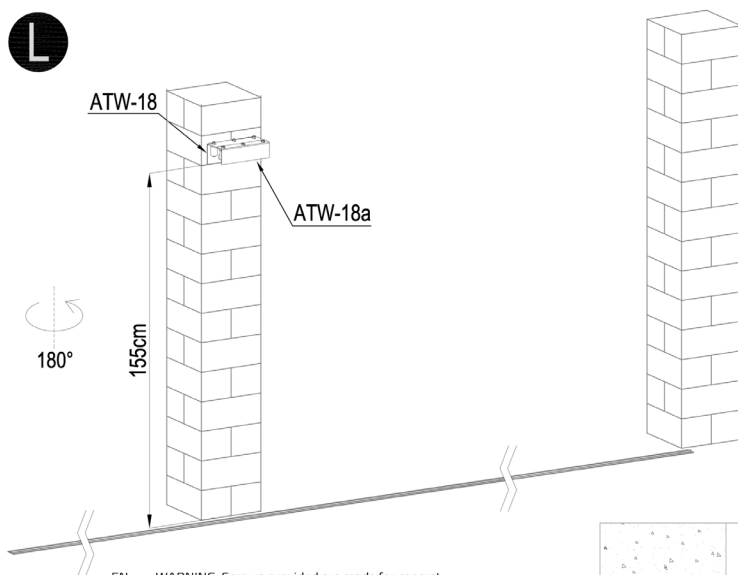

EN: WARNING: Screws provided are made for concret.  
 FR: AVERTISSEMENT : Les vis fournies sont faites pour le béton.  
 DE: WARNUNG: Die mitgelieferten Schrauben sind für Beton ausgelegt.  
 ES: ADVERTENCIA: Los tornillos suministrados están hechos para el hormigón.  
 IT: ATTENZIONE: Le viti fornite sono fatte per il calcestruzzo.  
 NL: WAARSCHUWING: De bijgeleverde schroeven zijn gemaakt voor beton.  
 PL: OSTRZEŻENIE: Dostarczone śruby są przeznaczone do betonu.  
 PT: AVISO: Os parafusos fornecidos são feitos para betão.

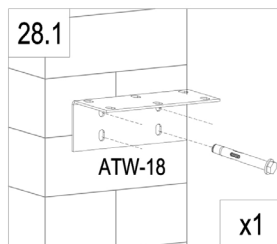
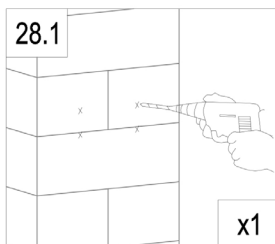
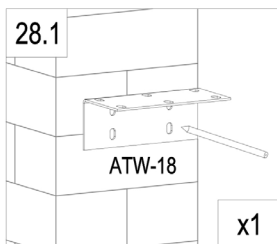
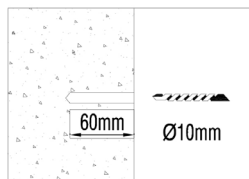

	ATW-18	1
	ATW-18a	1
	AT-20	6
	CKW-H31	4

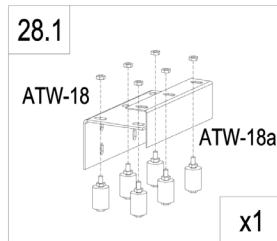
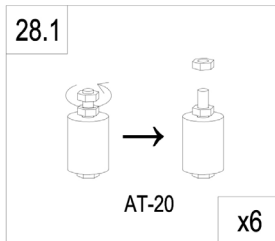

L

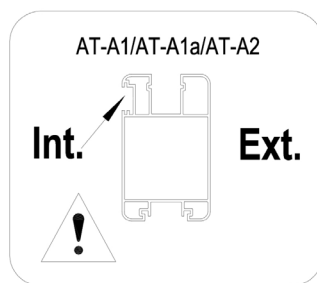
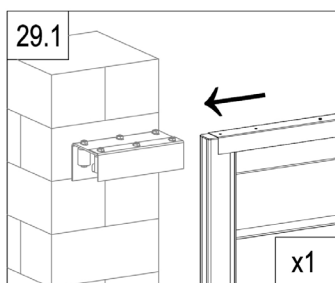
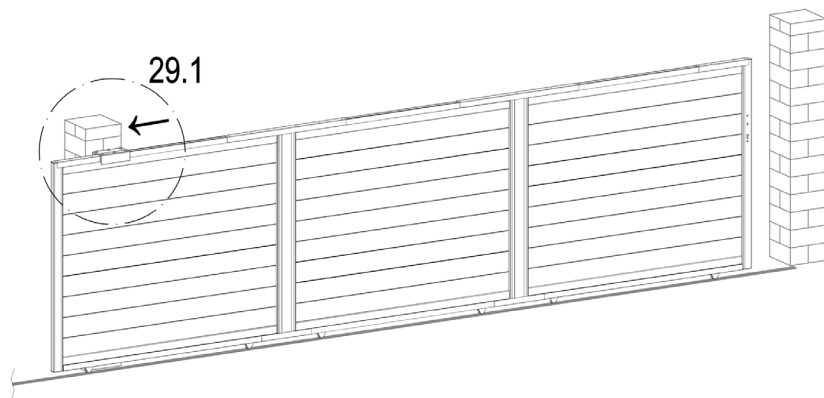

L

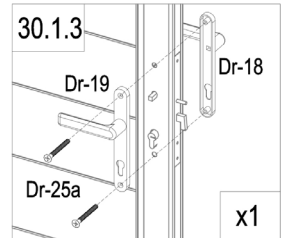
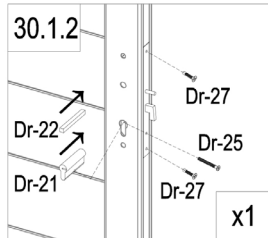
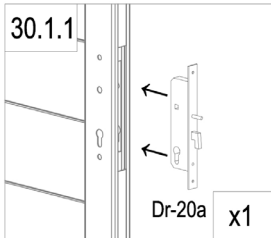
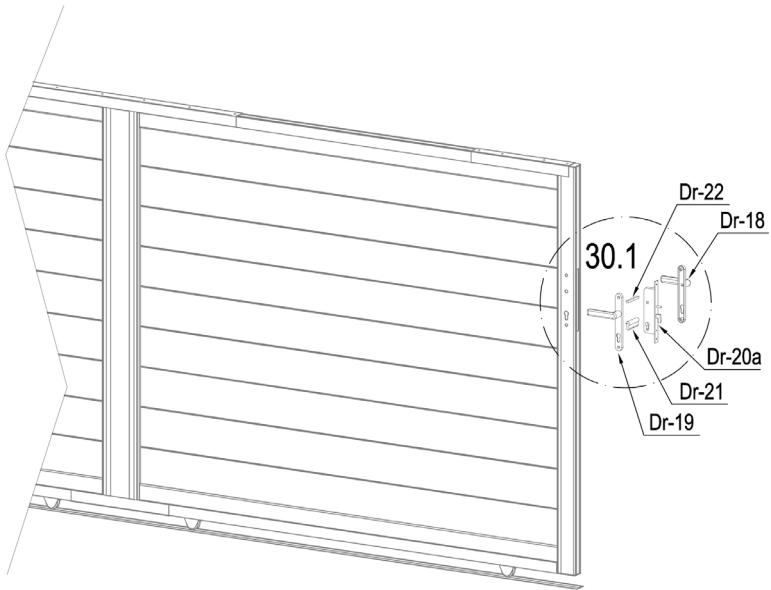

	Dr-20a	1
	Dr-21	1
	Dr-22	1
	Dr-25	1

	Dr-18	1
	Dr-19	1
	Dr-25a	2
	Dr-27	2



EN: WARNING: Screws provided are made for concret.  
 FR: AVERTISSEMENT : Les vis fournies sont faites pour le béton.  
 DE: WARNUNG: Die mitgelieferten Schrauben sind für Beton ausgelegt.  
 ES: ADVERTENCIA: Los tornillos suministrados están hechos para el hormigón.  
 IT: ATTENZIONE: Le viti fornite sono fatte per il calcestruzzo.  
 NL: WAARSCHUWING: De bijgeleverde schroeven zijn gemaakt voor beton.  
 PL: OSTRZEŻENIE: Dostarczone śruby są przeznaczone do betonu.  
 PT: AVISO: Os parafusos fornecidos são feitos para betão.

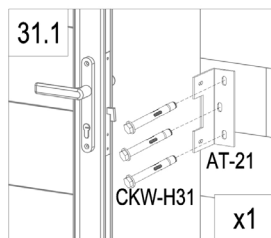
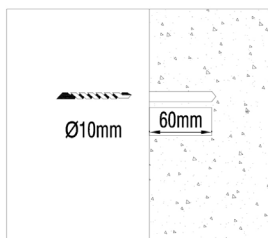
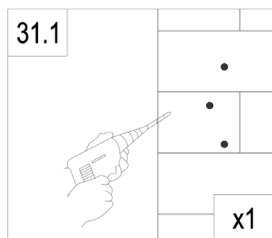
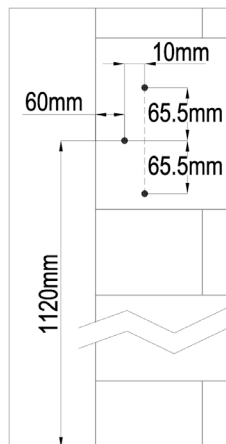
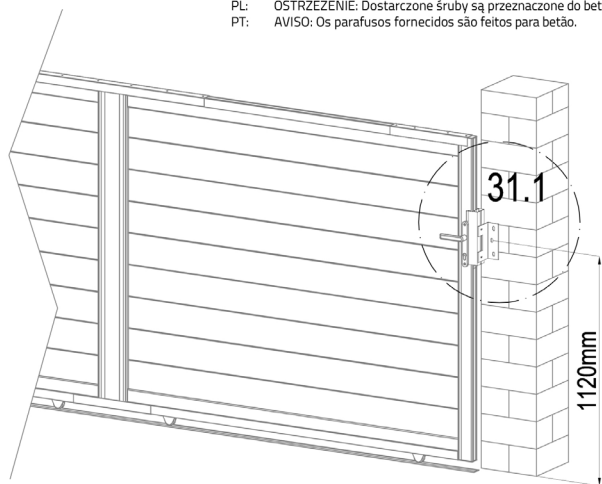

	AT-16	1
	AT-21	1
	CKW-H36	2
	CKW-H31	3
	ATW-22J	3

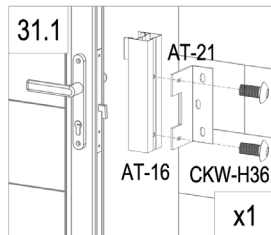
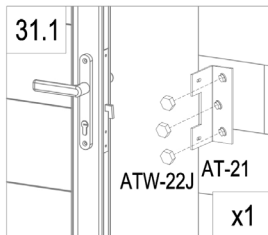



L

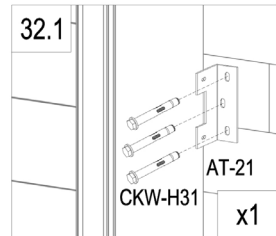
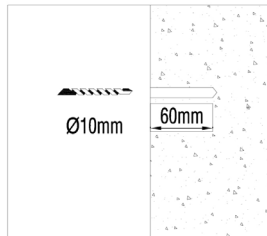
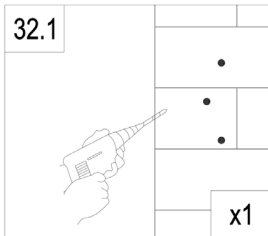
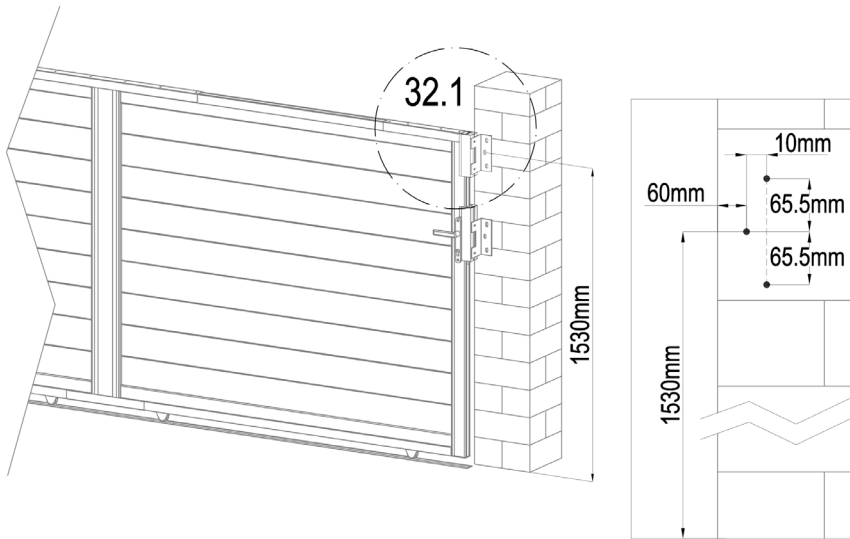

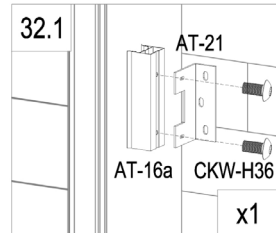
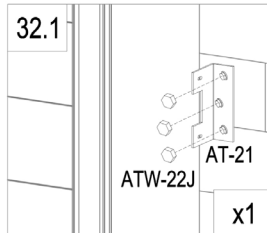

	AT-16a	1
	AT-21	1
	CKW-H36	2
	CKW-H31	3
	ATW-22J	3

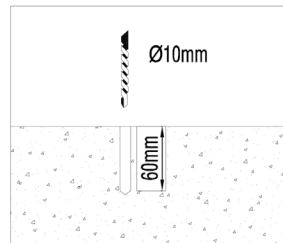
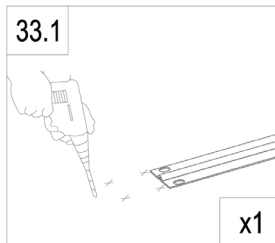
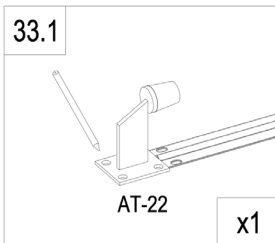
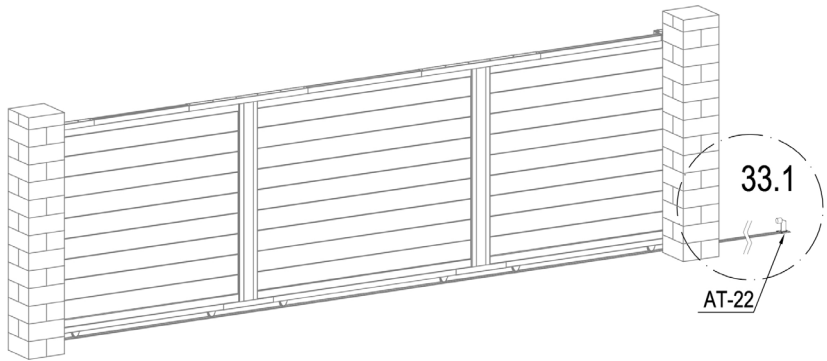

L



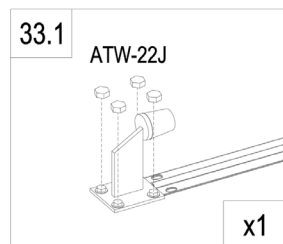
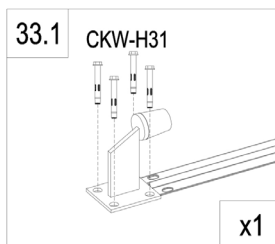

	AT-22	1
	CKW-H31	4
	ATW-22J	4

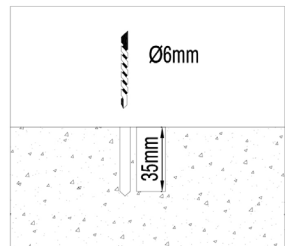
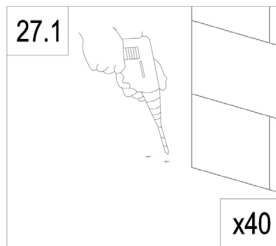
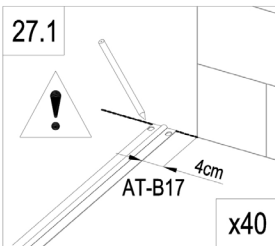
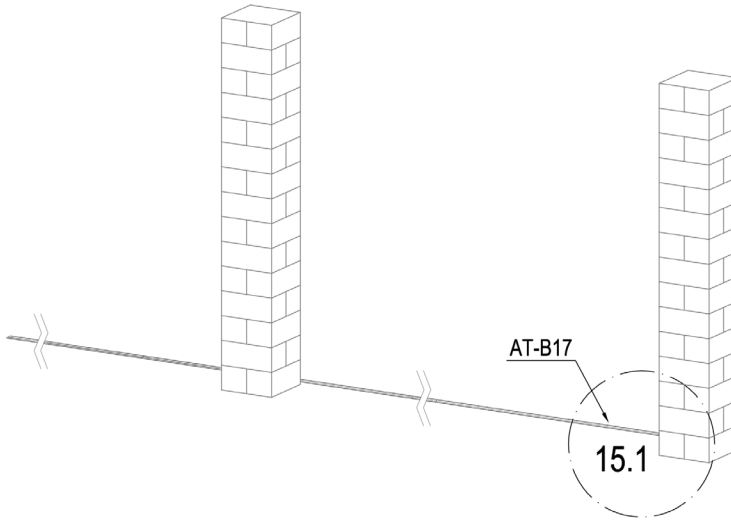

R



	AT-B17	8
	CKW-H38	80

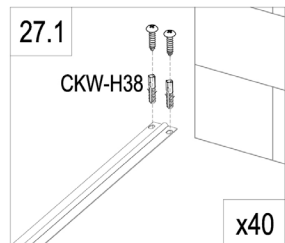

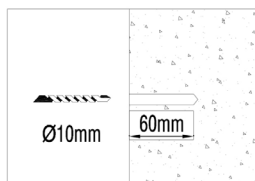
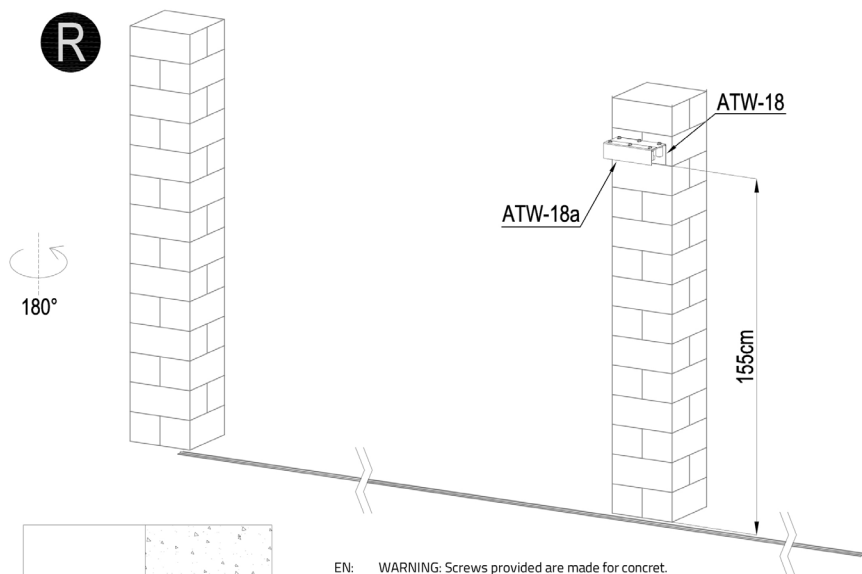

EN: WARNING: Screws provided are made for concrete.  
 FR: AVERTISSEMENT : Les vis fournies sont faites pour le béton.  
 DE: WARNUNG: Die mitgelieferten Schrauben sind für Beton ausgelegt.  
 ES: ADVERTENCIA: Los tornillos suministrados están hechos para el hormigón.  
 IT: ATTENZIONE: Le viti fornite sono fatte per il calcestruzzo.  
 NL: WAARSCHUWING: De bijgeleverde schroeven zijn gemaakt voor beton.  
 PL: OSTRZEŻENIE: Dostarczone śruby są przeznaczone do betonu.  
 PT: AVISO: Os parafusos fornecidos são feitos para betão.

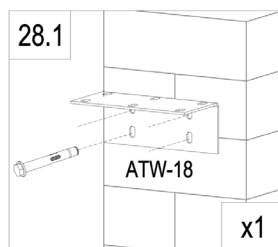
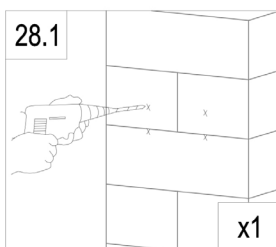
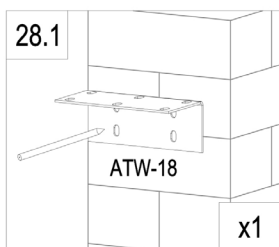

	ATW-18	1
	ATW-18a	1
	AT-20	6
	CKW-H31	4

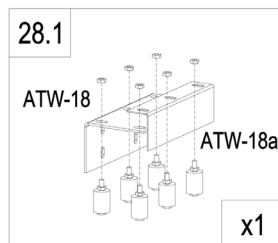
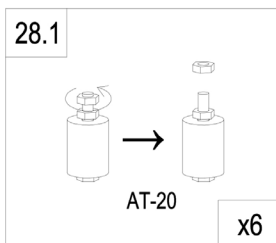



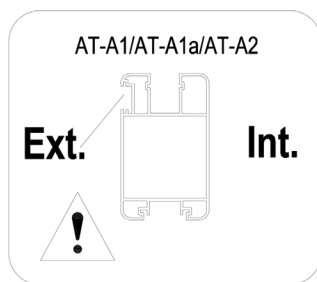
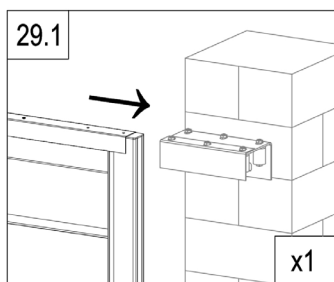
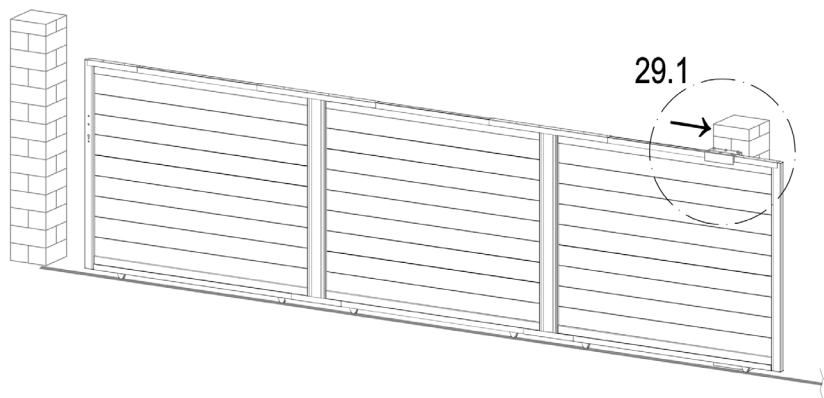



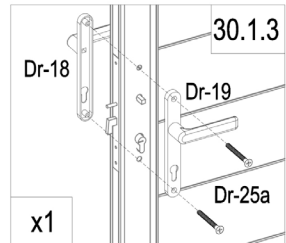
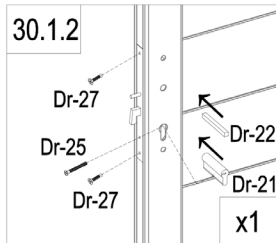
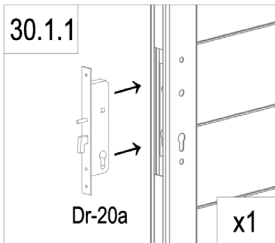
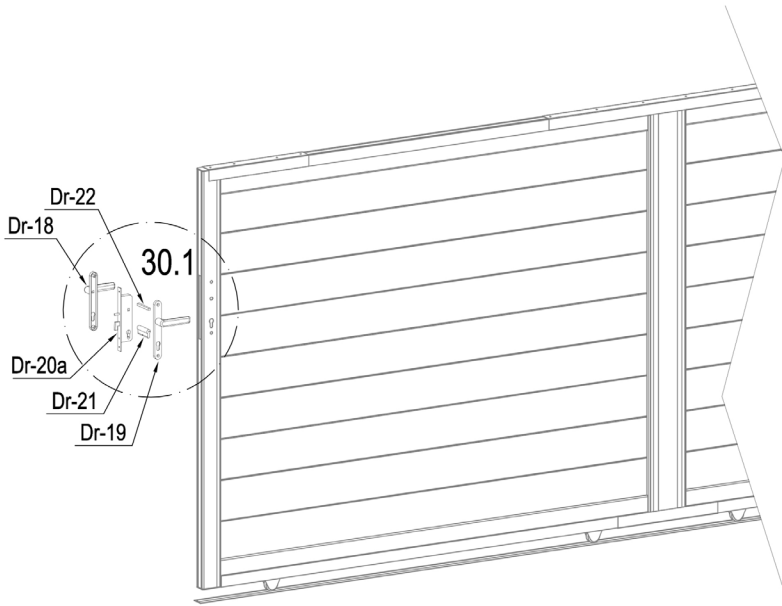

R



R



	Dr-20a	1
	Dr-21	1
	Dr-22	1
	Dr-25	1

	Dr-18	1
	Dr-19	1
	Dr-25a	2
	Dr-27	2



EN: WARNING: Screws provided are made for concret.  
 FR: AVERTISSEMENT : Les vis fournies sont faites pour le béton.  
 DE: WARNUNG: Die mitgelieferten Schrauben sind für Beton ausgelegt.  
 ES: ADVERTENCIA: Los tornillos suministrados están hechos para el hormigón.  
 IT: ATTENZIONE: Le viti fornite sono fatte per il calcestruzzo.  
 NL: WAARSCHUWING: De bijgeleverde schroeven zijn gemaakt voor beton.  
 PL: OSTRZEŻENIE: Dostarczone śruby są przeznaczone do betonu.  
 PT: AVISO: Os parafusos fornecidos são feitos para betão.

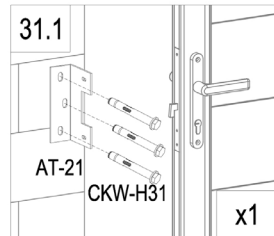
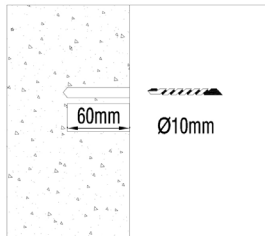
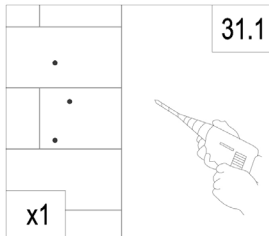
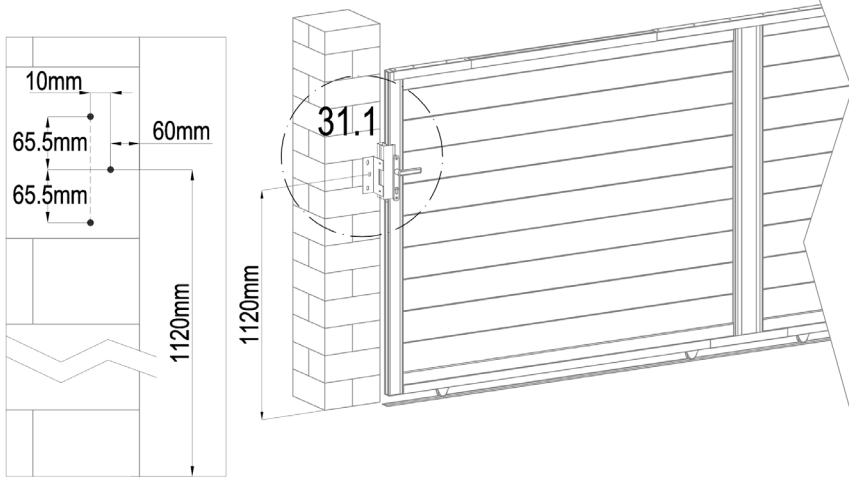

	AT-16	1
	AT-21	1
	CKW-H36	2
	CKW-H31	3
	ATW-22J	3

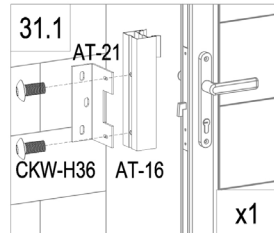
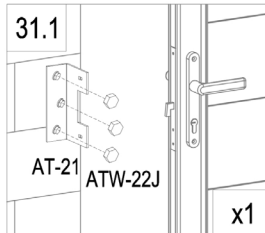

R

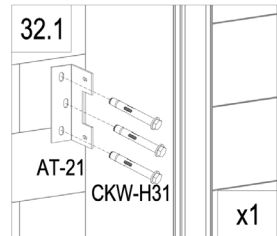
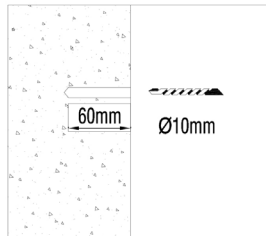
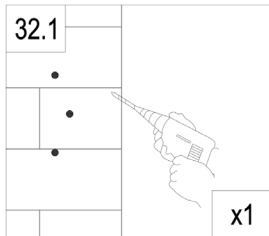
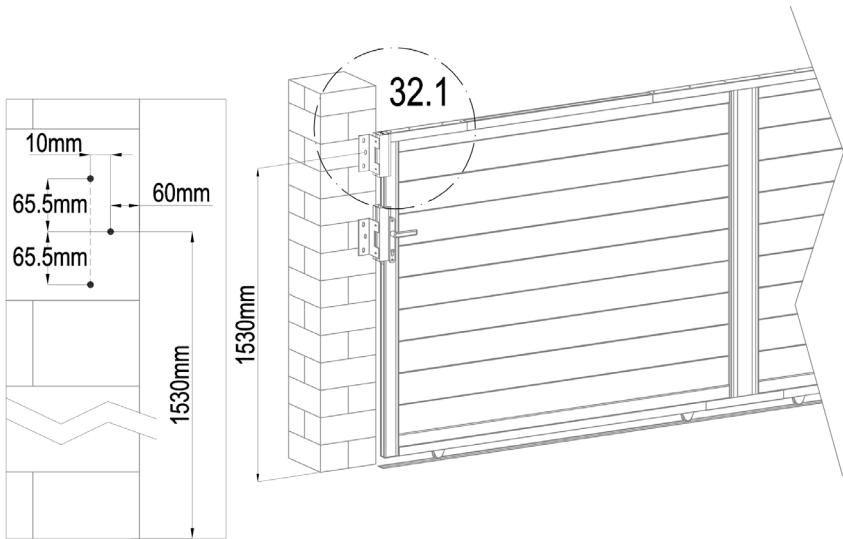

	AT-16a	1
	AT-21	1
	CKW-H36	2
	CKW-H31	3
	ATW-22J	3

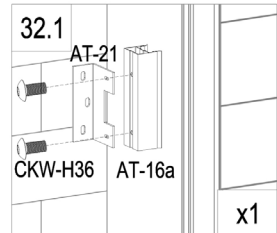
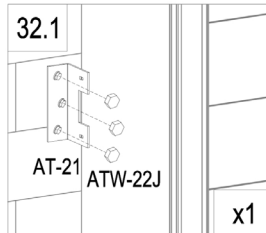



R

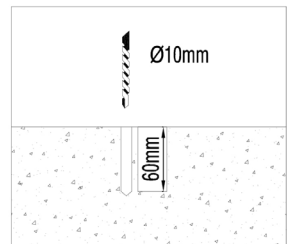
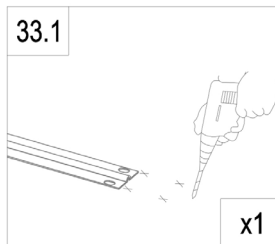
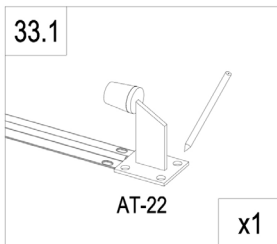
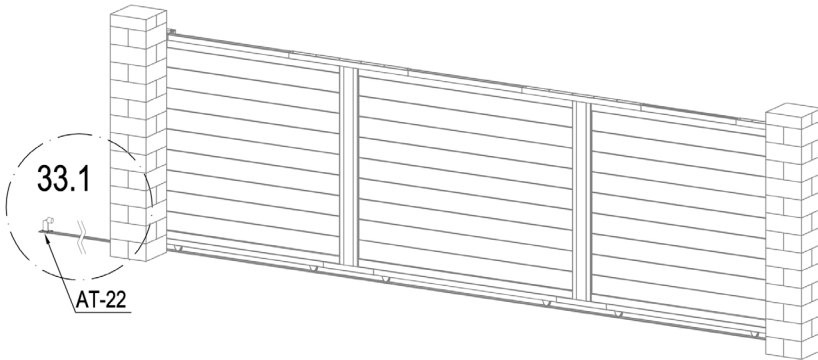

	AT-22	1
	CKW-H31	4
	ATW-22J	4

