

CASANOVO

GIONA 400C160

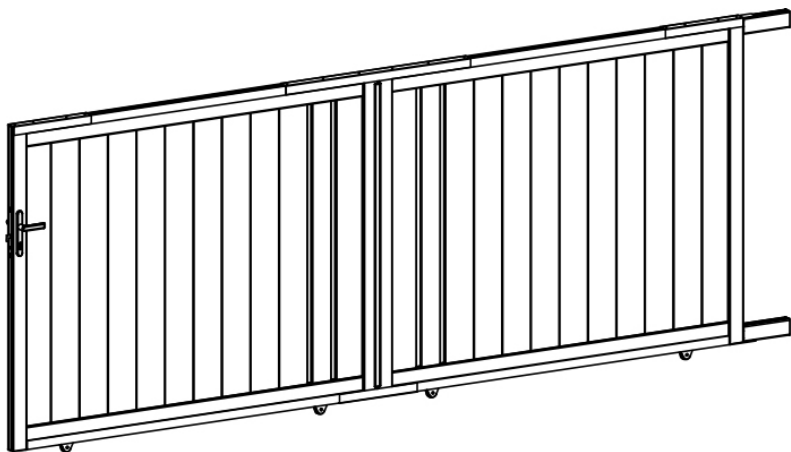

COM-000817 [x1]

COM-000819 [x1]

COM-000818 [x1]



7-8H



X 2



INSTRUCTION MANUAL / NOTICE DE MONTAGE / MONTAGEANLEITUNG / MANUAL DE MONTAJE / MANUAL DE MONTAGEM / MANUALE DI MONTAGGIO /
MONTAGEHANDLEIDING / INSTRUKCJA MONTAŻU / KÄYTTÖOHJEET / BRUKSANVISNING / BRUGSANVISNING / INSTRUCIUNI DE ASAMBLARE /
NAVODILA ZA SESTAVLJANJE / NÁVOD NA MONTÁŽ / ÖSSZESZERELÉSI ÚTMUTATÓ / NÁVOD K MONTÁŽI / UPUTE ZA INSTALACIJU /
ΟΔΗΓΙΕΣ ΣΥΝΑΡΜΟΛΟΓΗΣΗΣ / SURINKIMO INSTRUKCIJOS / MONTĀŽAS INSTRUKCIJAS

Ext.

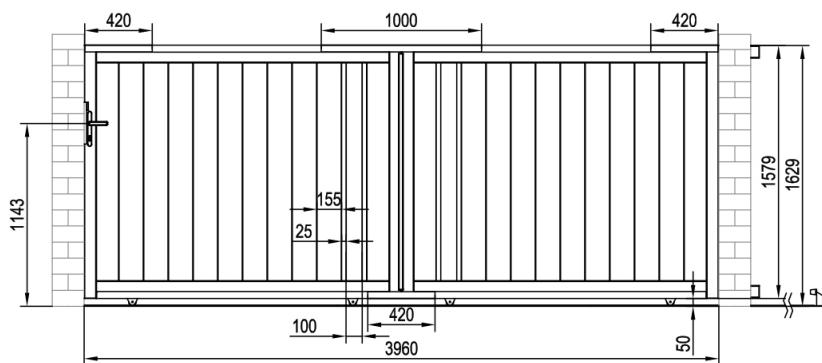

Int.

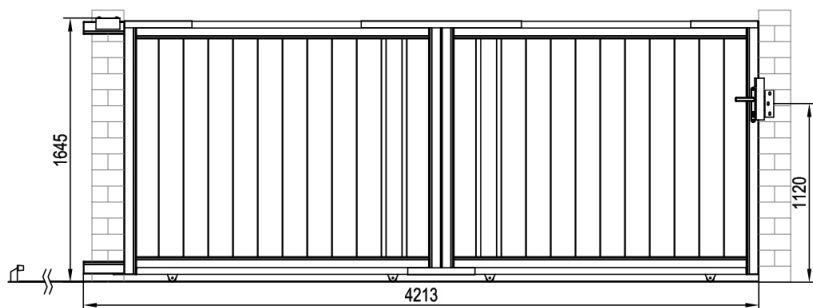

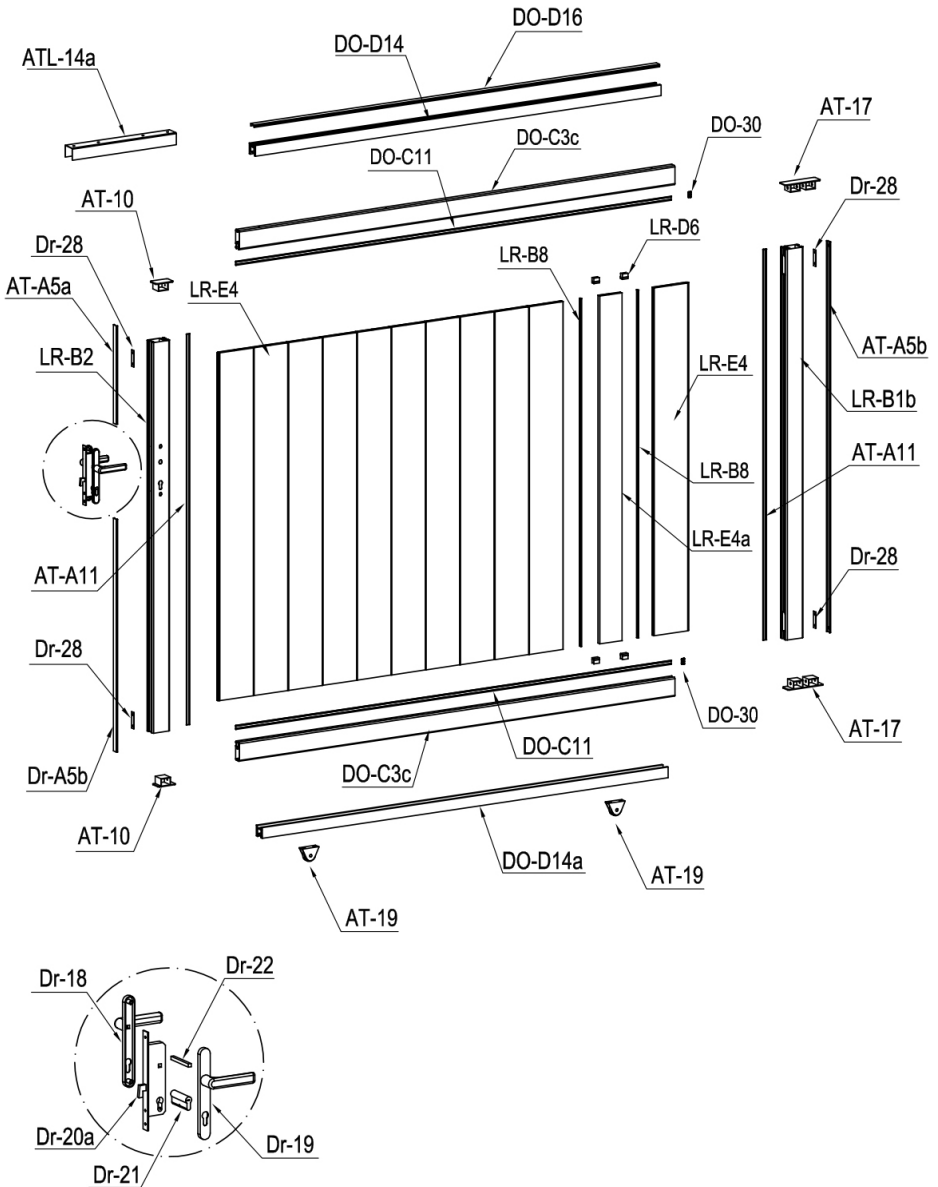

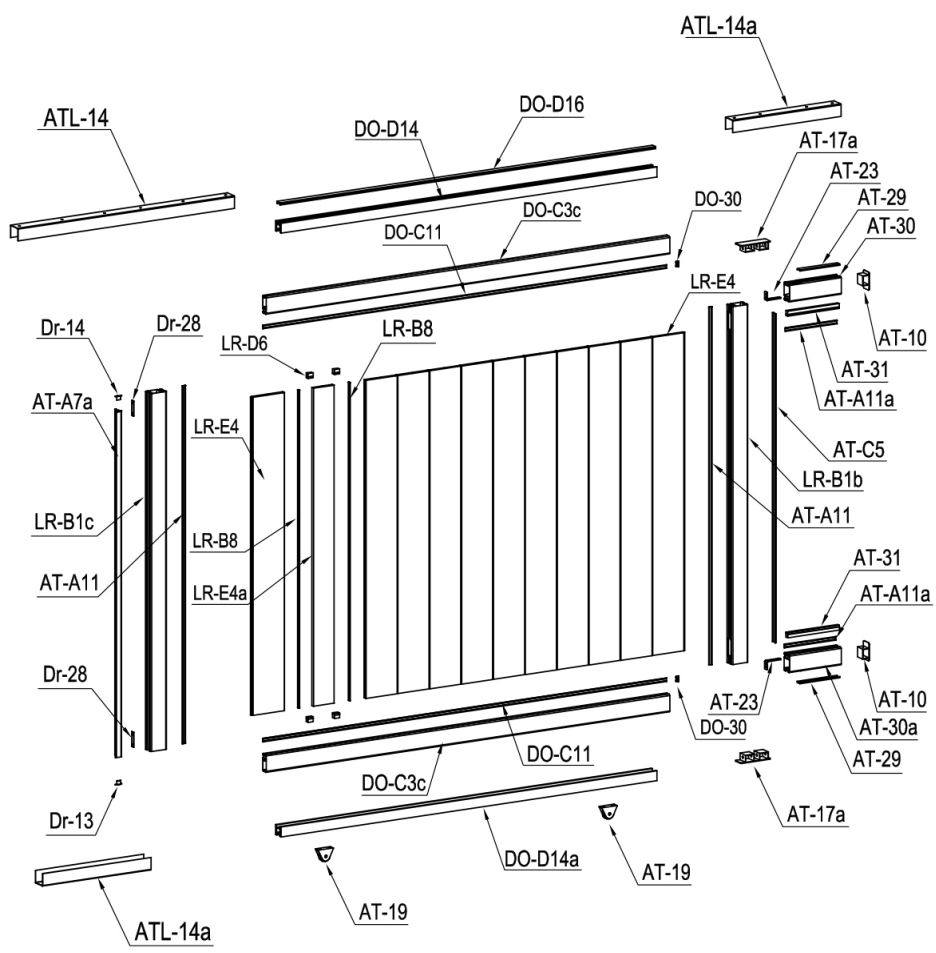

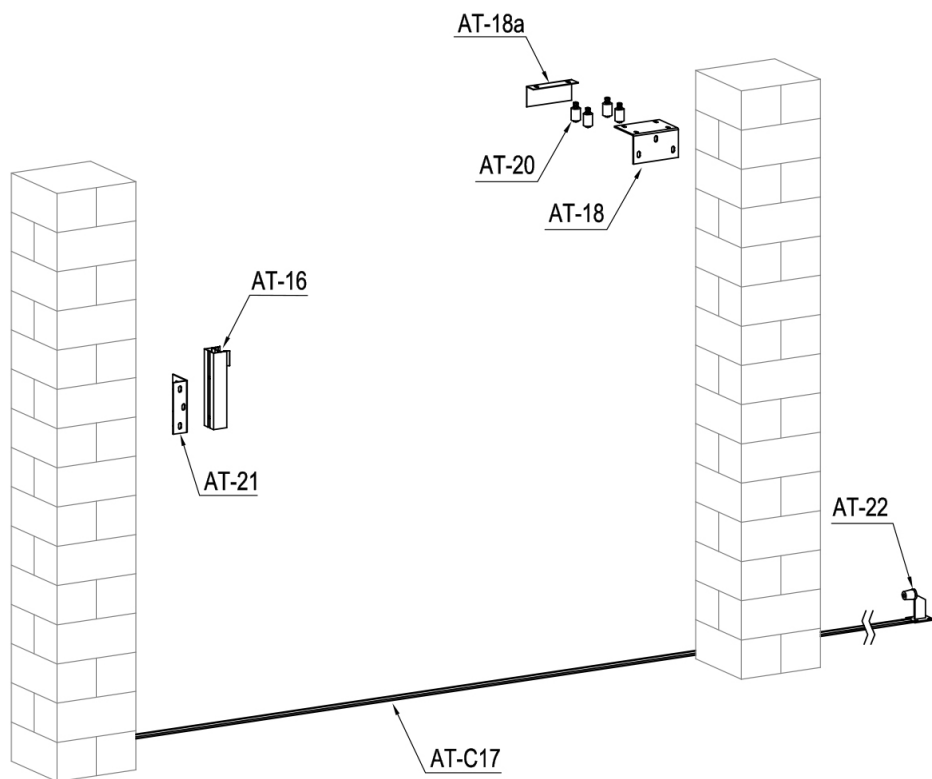
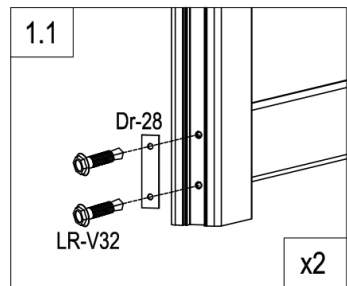
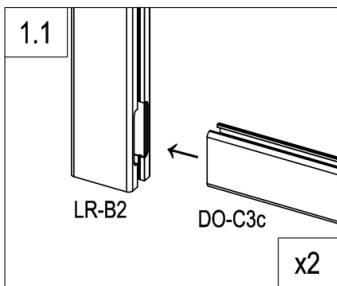
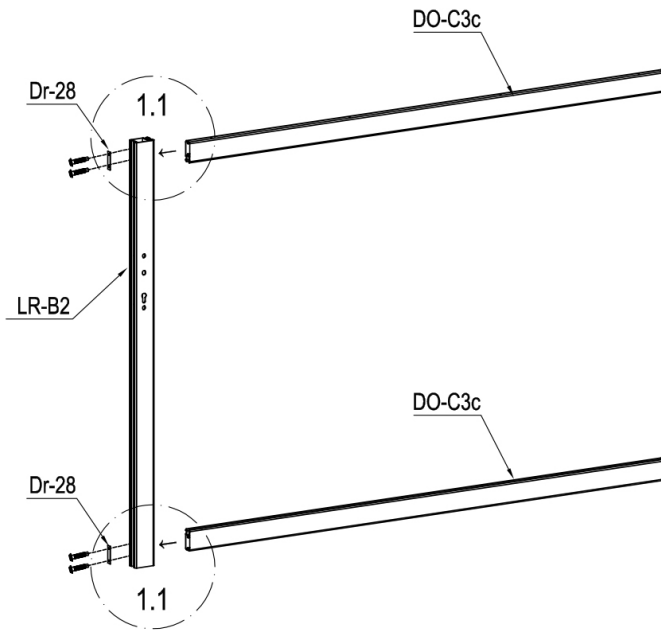



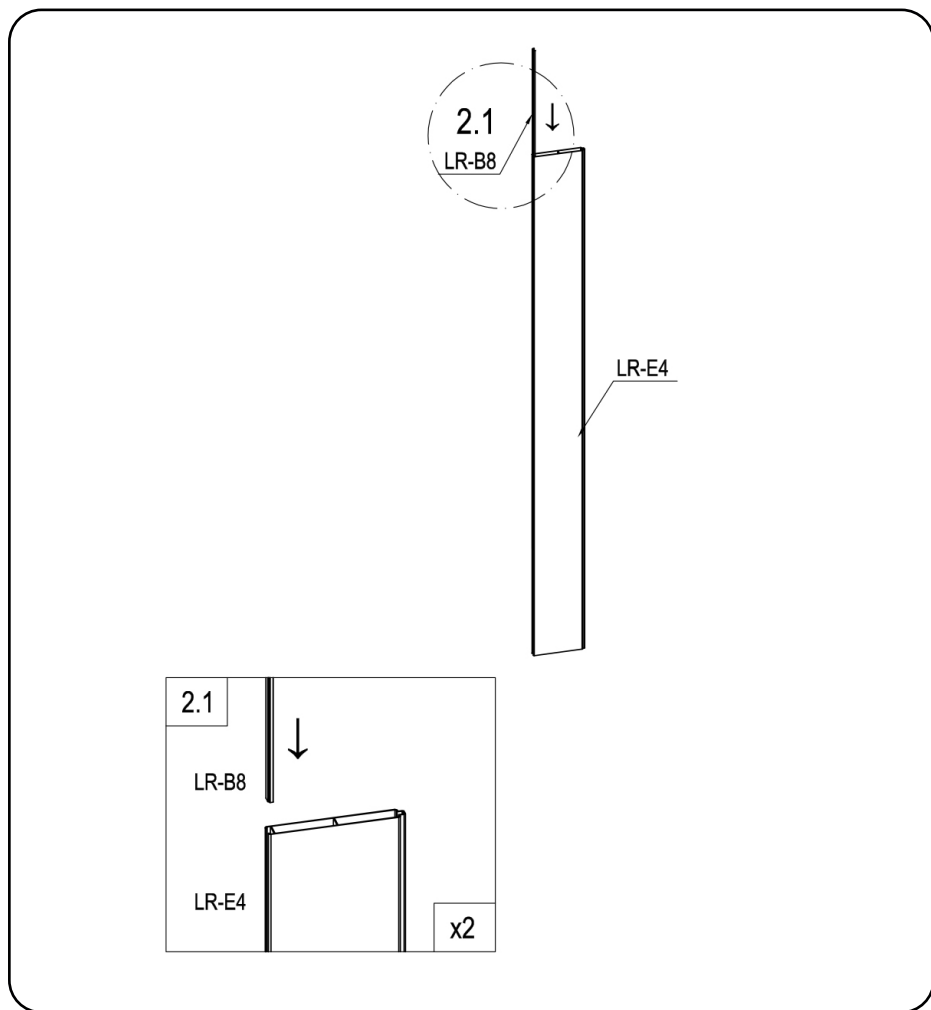



IMAGE	NO.	L.(mm)	QTY	IMAGE	NO.	L.(mm)	QTY
	LR-B1b	1573	2		ATL-14	1000	1
	LR-B1c	1573	1		ATL-14a	420	3
	LR-B2	1573	1		DO-30		4
	AT-30	250	1		AT-18		1
	AT-30a	250	1		AT-18a		1
	DO-C3c	1957	4		AT-19		4
	LR-E4	1400	22		AT-20		4
	LR-E4a	1400	2		AT-21		1
	AT-A5b	1573	1		AT-22		1
	AT-C5	1448	1		AT-23		2
	AT-A5a	395.5	1		Dr-18		1
	Dr-A5b	937	1		Dr-19		1
	AT-29	193	2		Dr-20a		1
	AT-A11	1573	4		Dr-21		1
	AT-A11a	250	2		Dr-22		1
	DO-C11	1957	4		Dr-25		1
	AT-31	250	2		Dr-25a		2
	LR-D6	25	8		Dr-27		2
	LR-B8	1400	4		Dr-28		6
	AT-A7a	1520	1		AT-22J		7
	DO-D14	1823	2		LR-V30		4
	DO-D14a	1823	2		LR-V31		10
	DO-D16	1822	2		LR-V32		32
	AT-16		1		LR-V33		4
	AT-C17	1580	5		LR-V34		26
	AT-17		2		LR-V35		54
	AT-17a		2		LR-V36		2
	AT-10		4		LR-V37		8
	Dr-13		1		LR-V38		50
	Dr-14		1				



	LR-B2	1
	DO-C3c	2
	Dr-28	2
	LR-V32	4



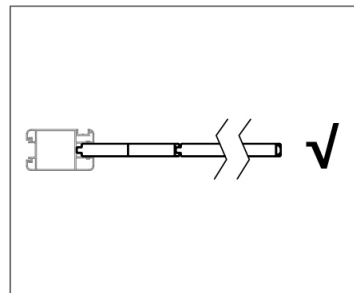
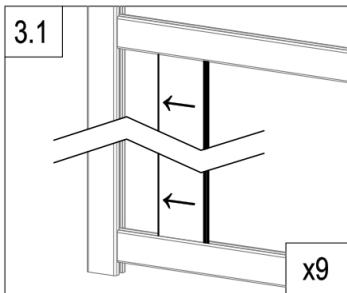
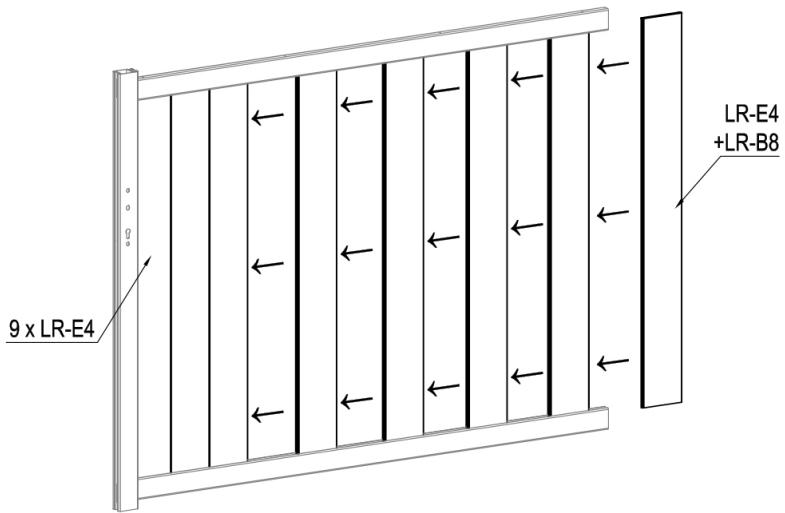

X2

	LR-B8	2
	LR-E4	2



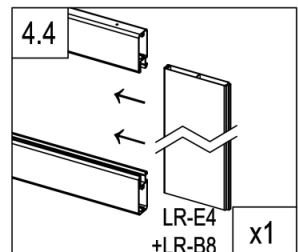
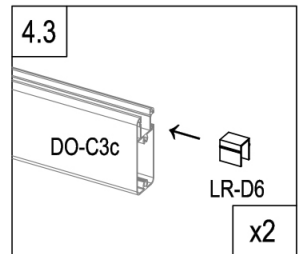
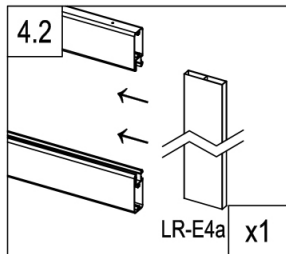
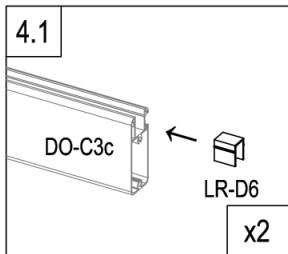
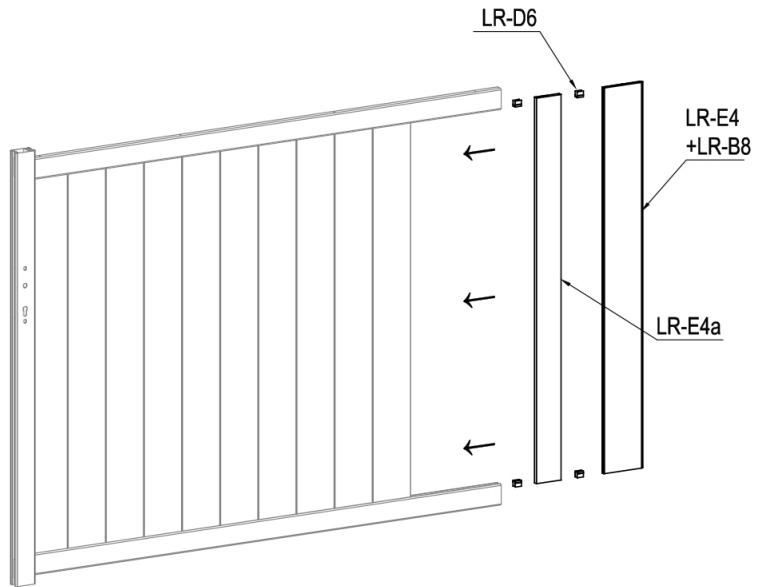

	LR-E4	9
---	-------	---



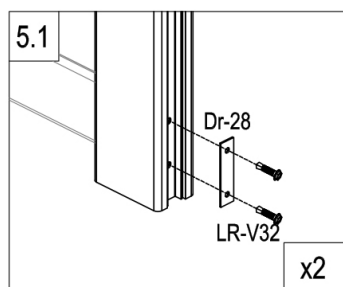
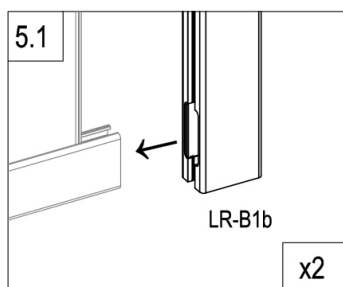
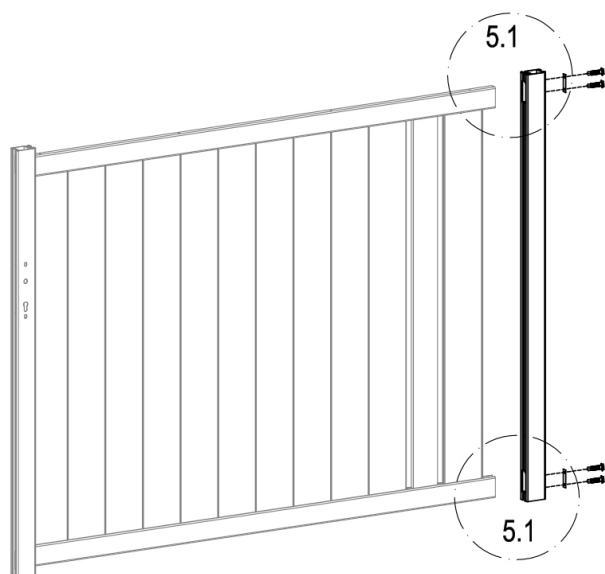

	LR-E4a	1
	LR-D6	4

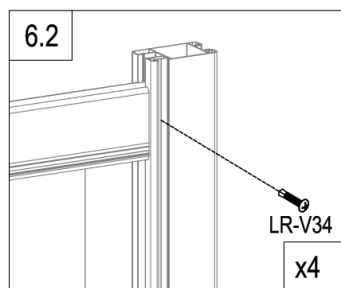
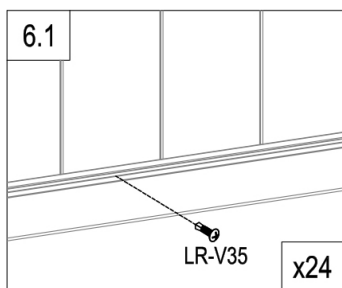
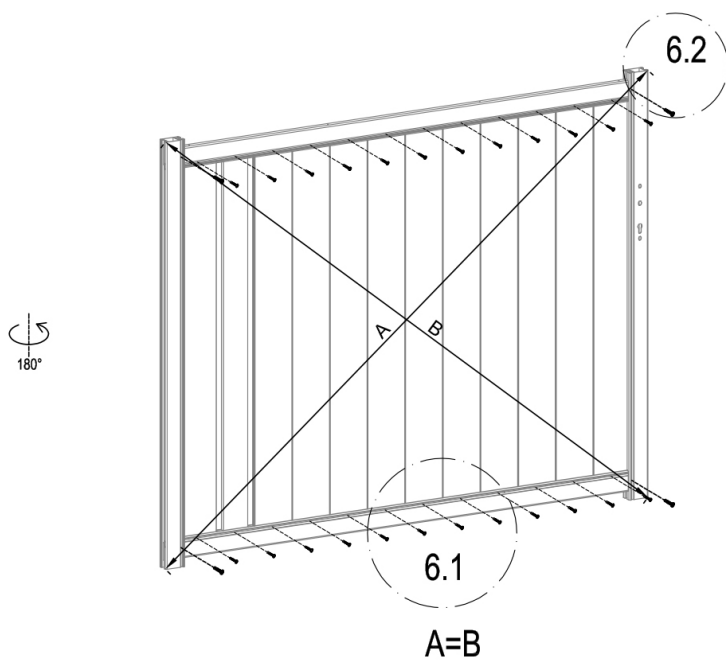

	LR-B1b	1
	Dr-28	2
	LR-V32	4



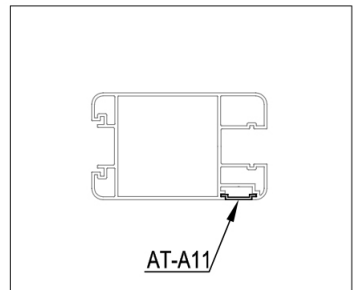
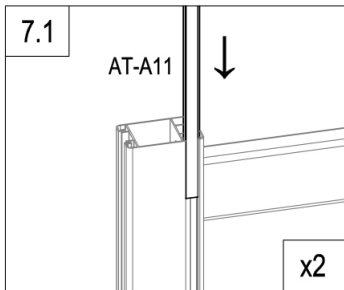
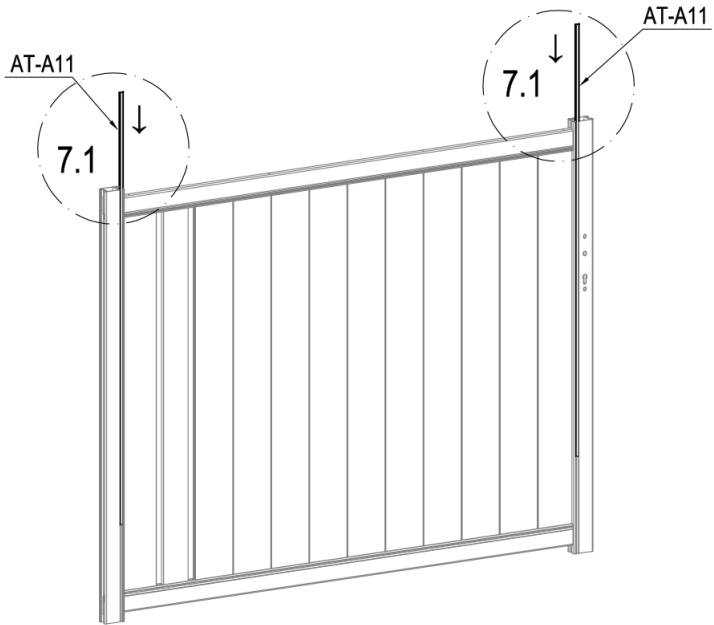

	LR-V35	24
	LR-V34	4

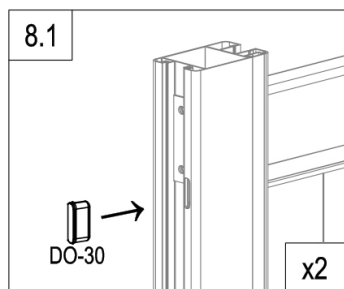
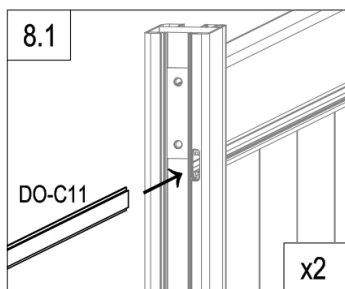
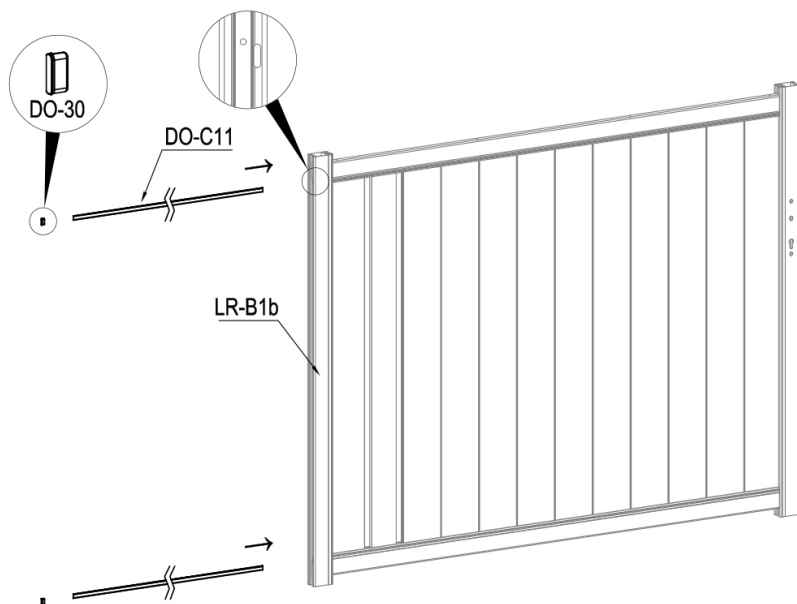

	AT-A11	2
---	--------	---



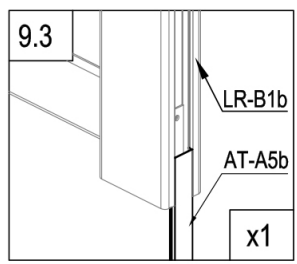
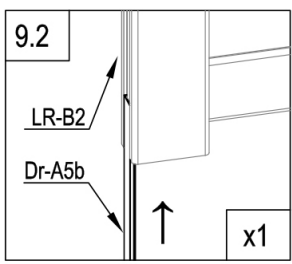
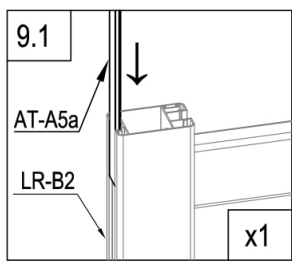
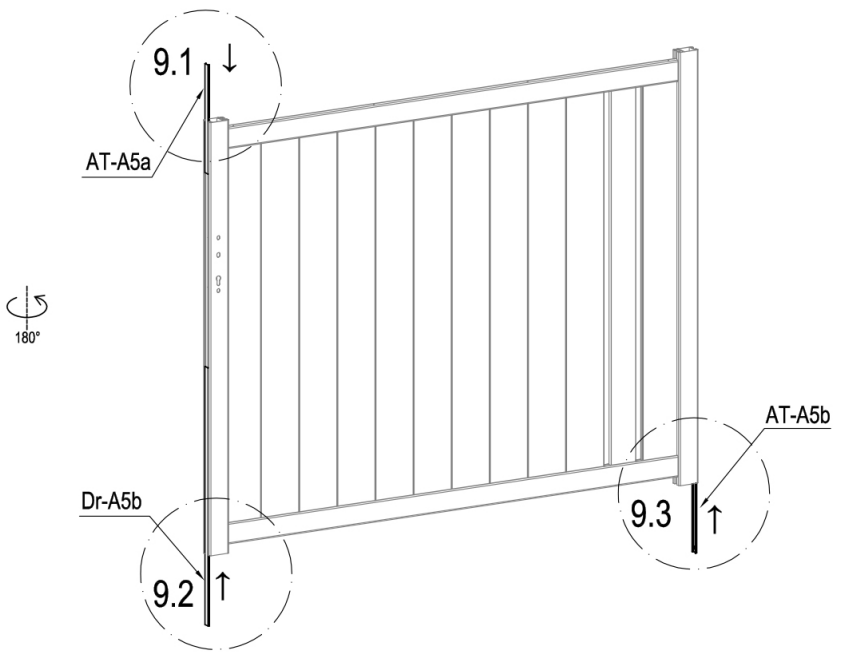

	DO-C11	2
	DO-30	2



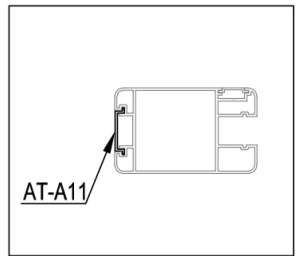

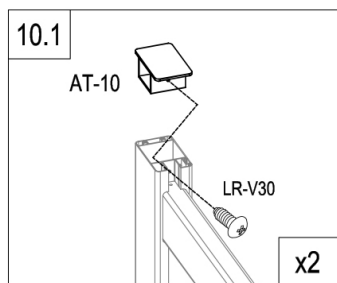
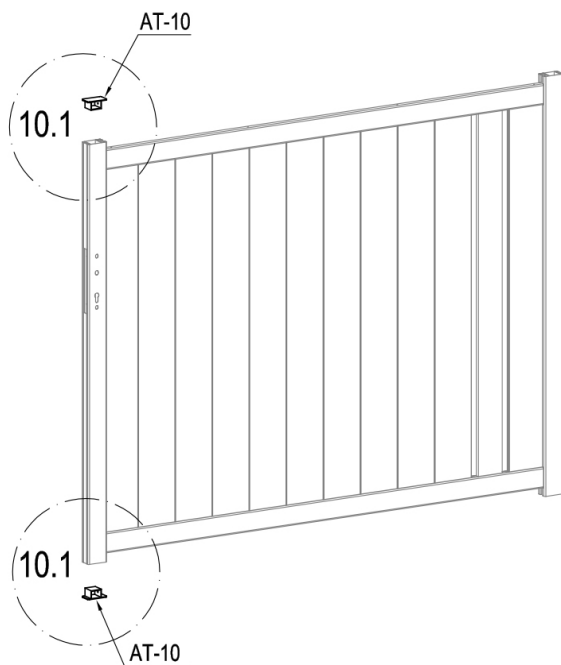

	AT-A5b	1
	AT-A5a	1
	Dr-A5b	1



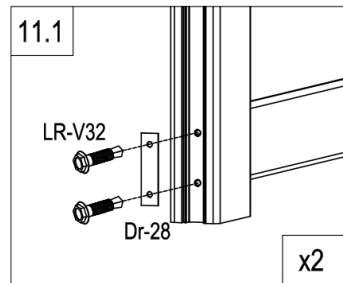
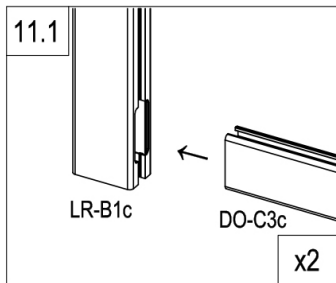
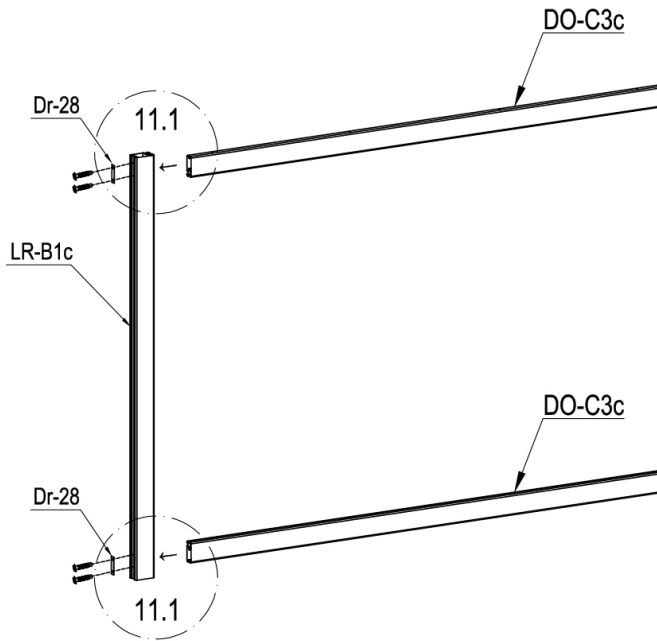



	AT-10	2
	LR-V30	2



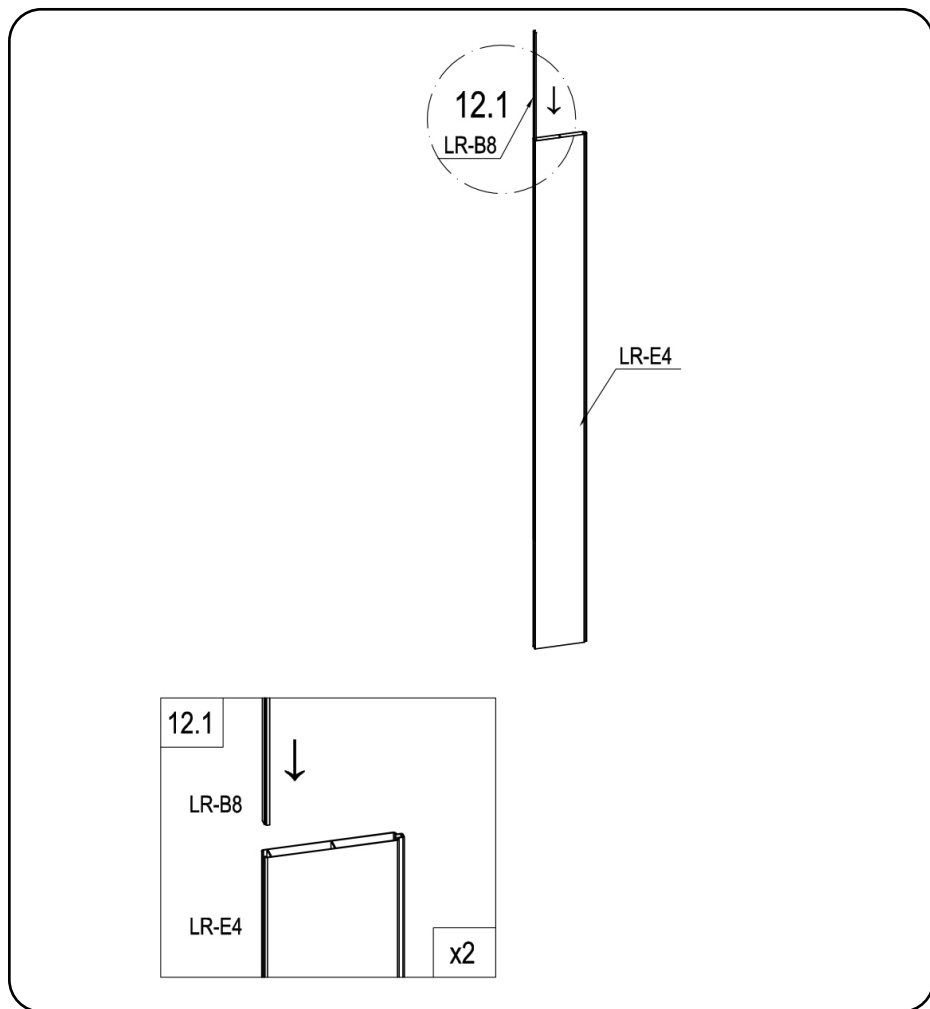

	LR-B1c	1
	DO-C3c	2
	Dr-28	2
	LR-V32	4



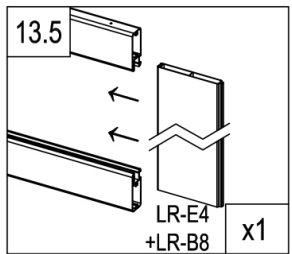
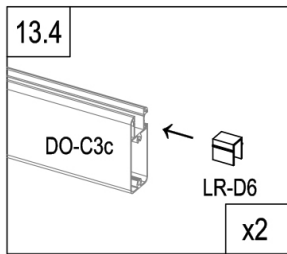
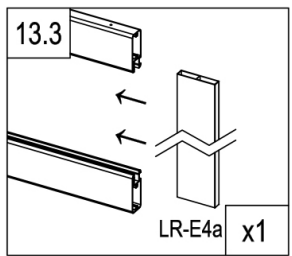
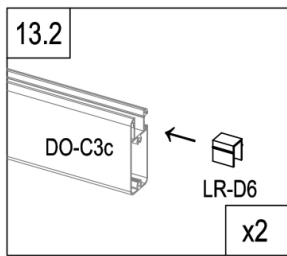
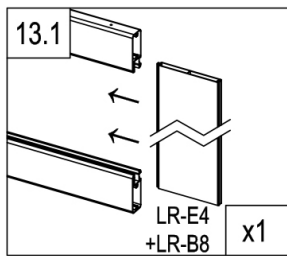
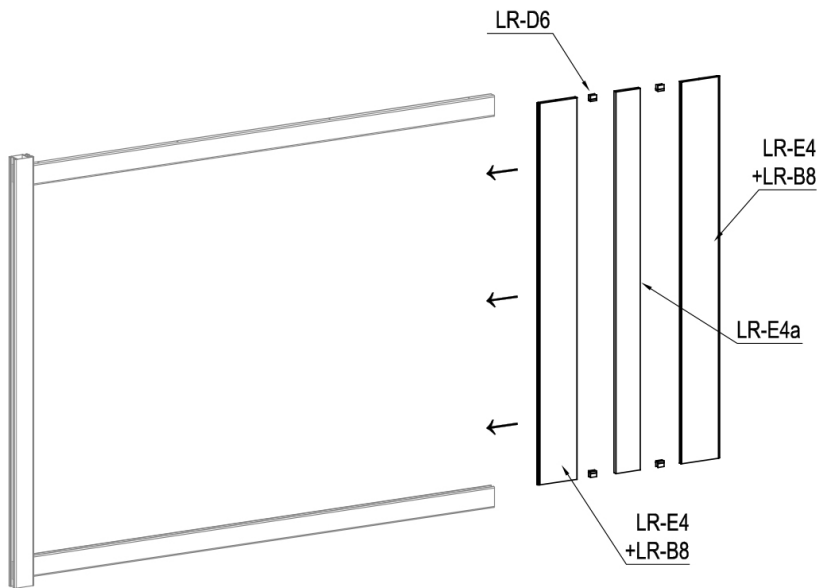

X2

	LR-B8	2
	LR-E4	2



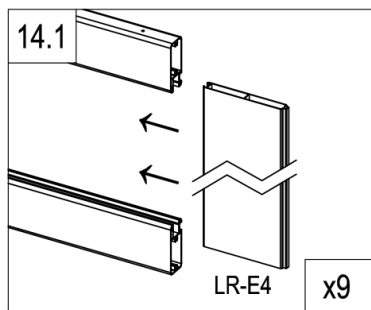
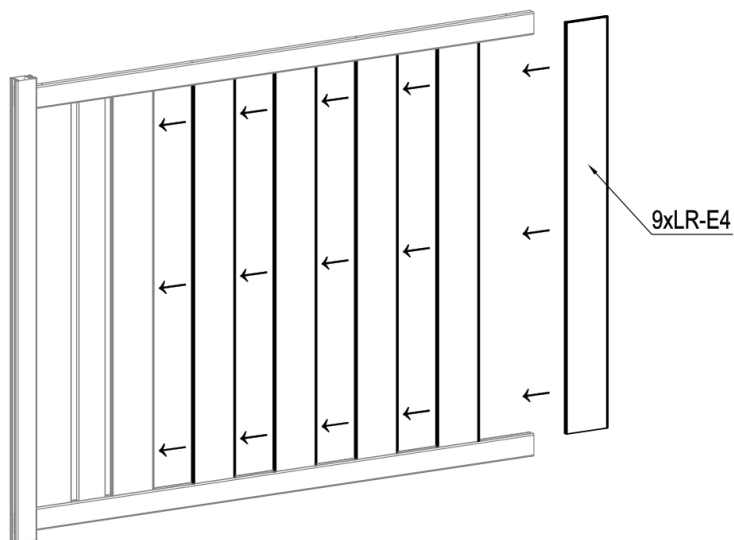

	LR-E4a	1
	LR-D6	4



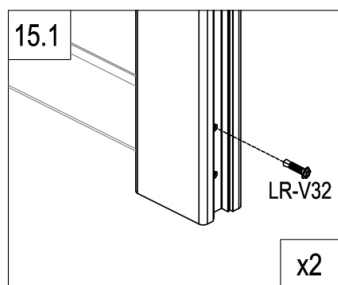
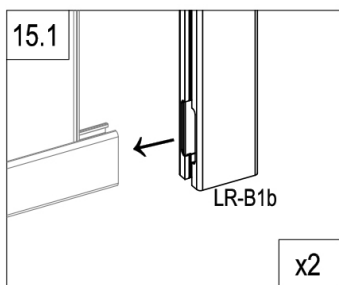
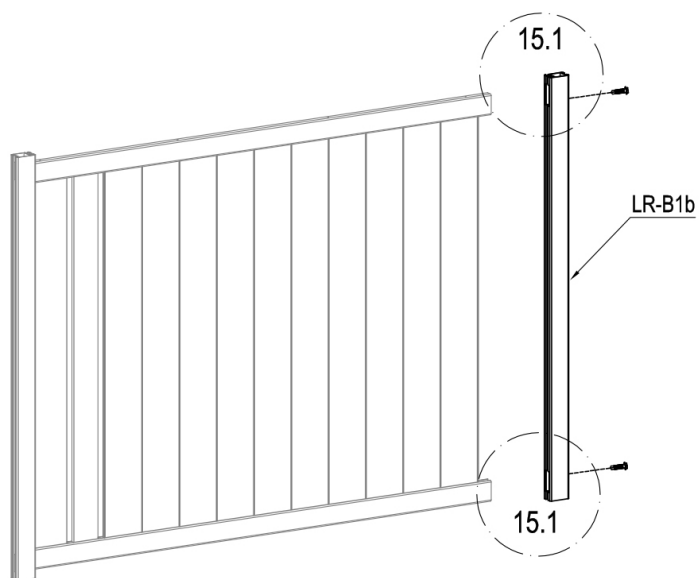

	LR-E4	9
---	-------	---

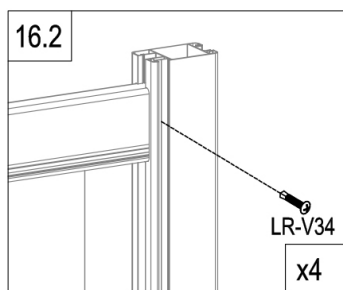
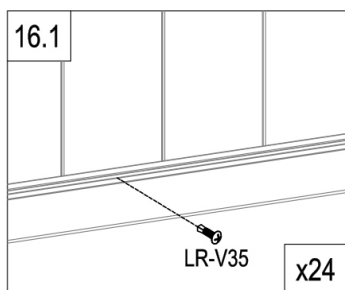
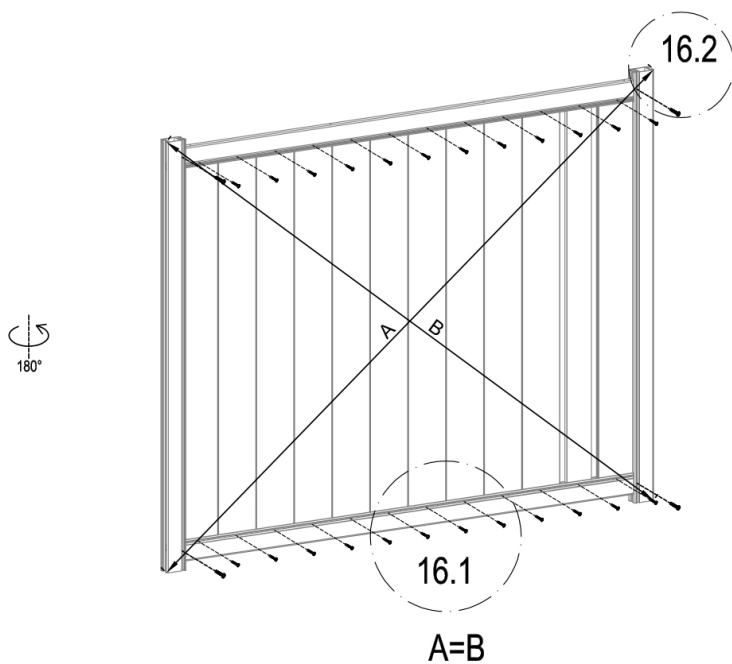

	LR-B1b	1
	LR-V32	2



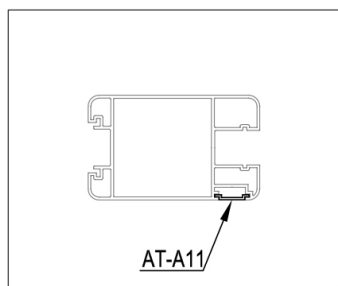
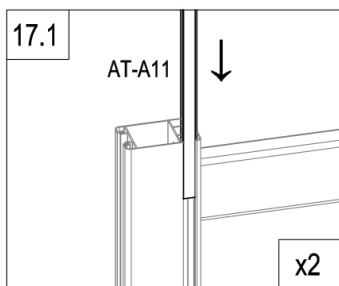
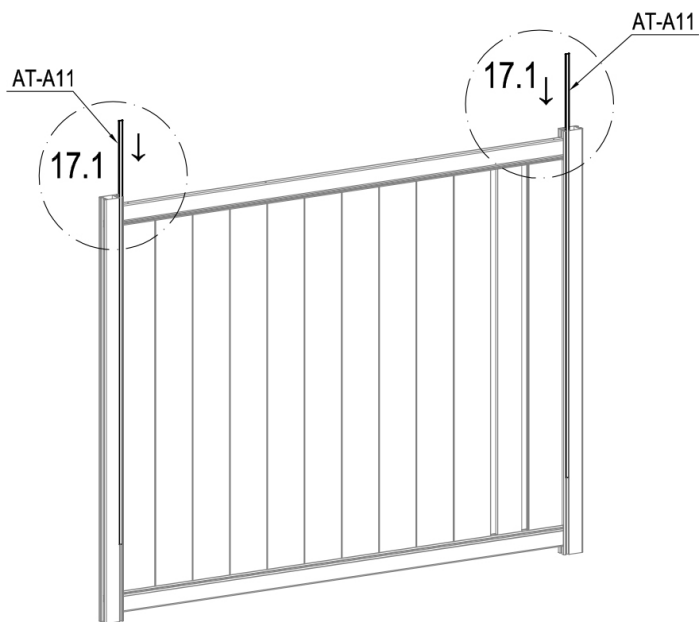

	LR-V35	24
	LR-V34	4



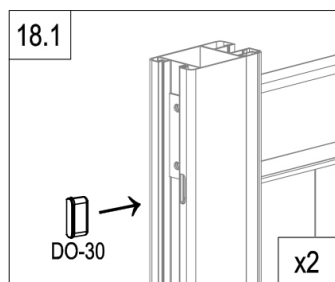
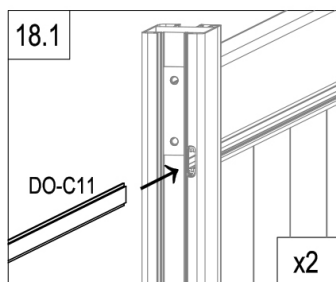
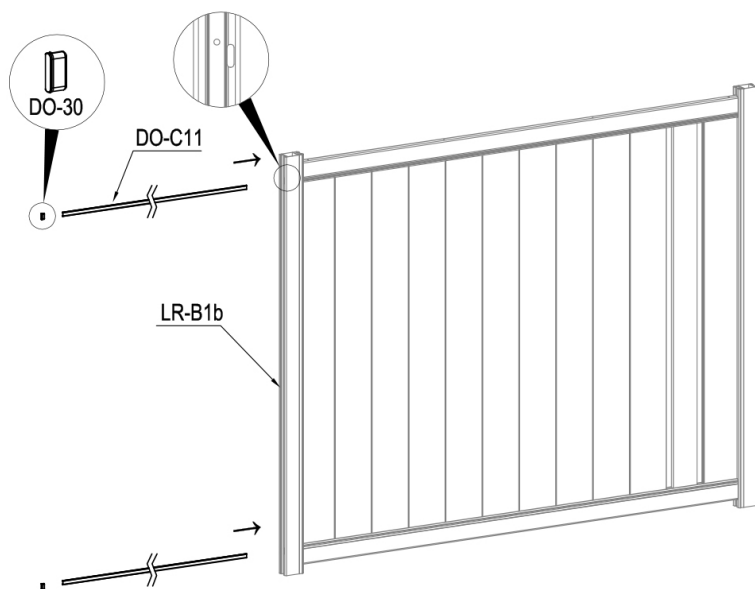



	AT-A11	2
---	--------	---

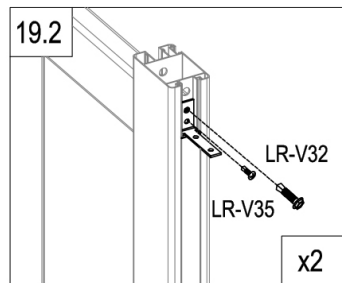
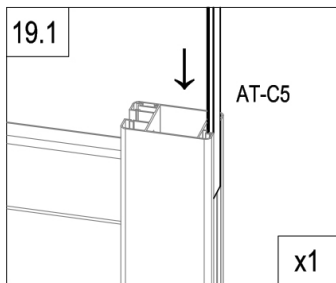
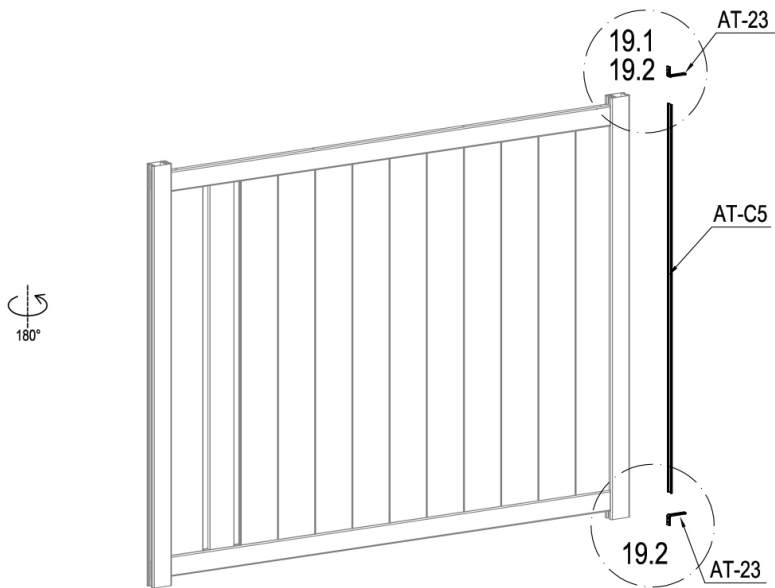





	DO-C11	2
	DO-30	2

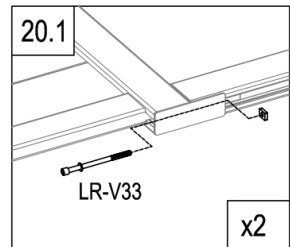
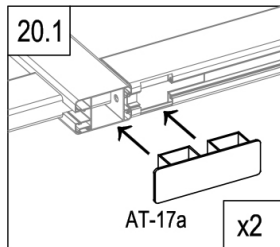
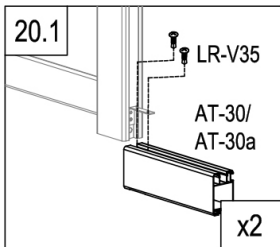
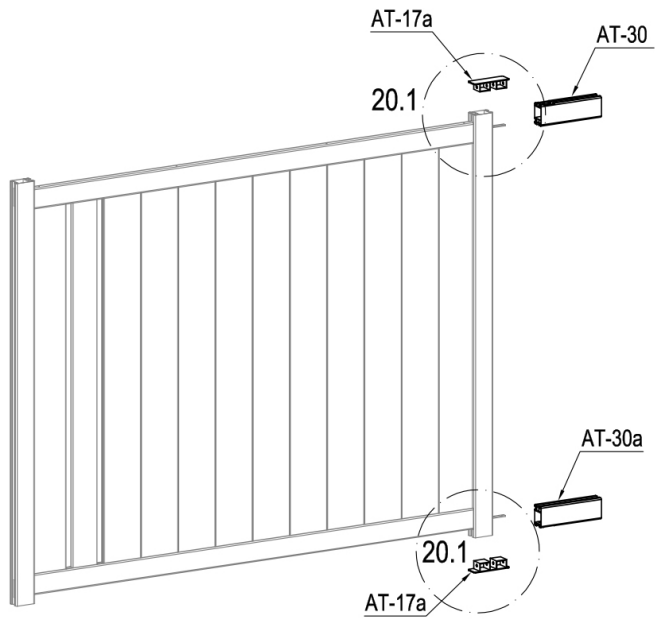





	AT-C5	1
	AT-23	2
	LR-V32	2
	LR-V35	2



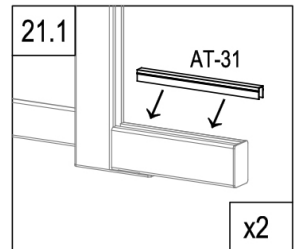
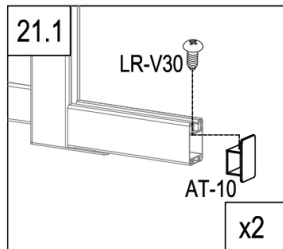
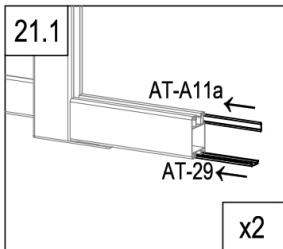
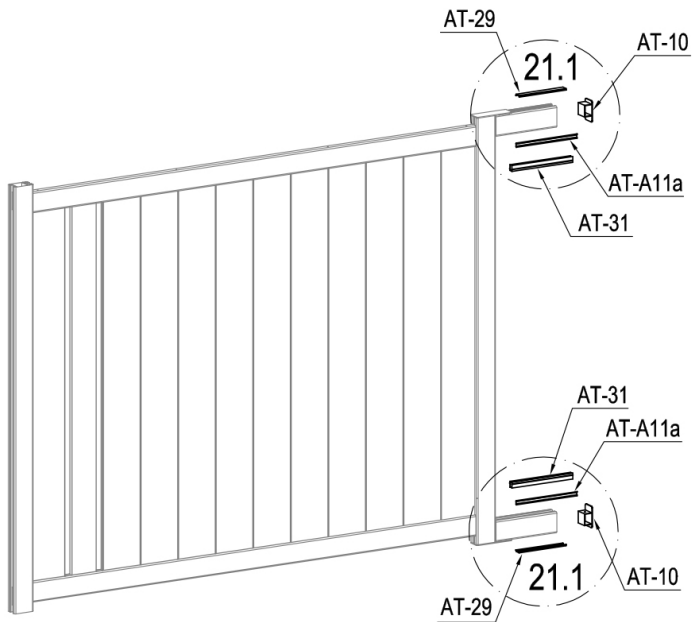

	AT-30	1
	AT-30a	1
	AT-17a	2





	LR-V33	2
	LR-V35	4



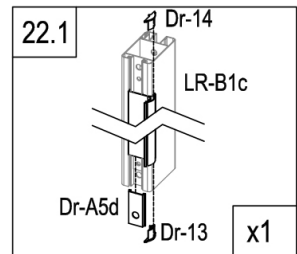
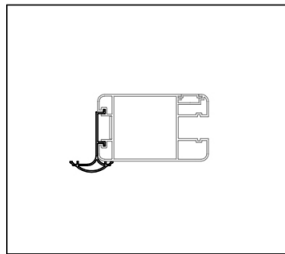
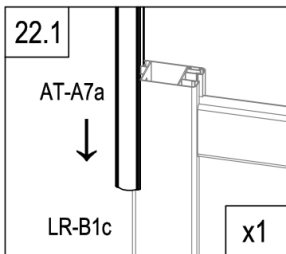
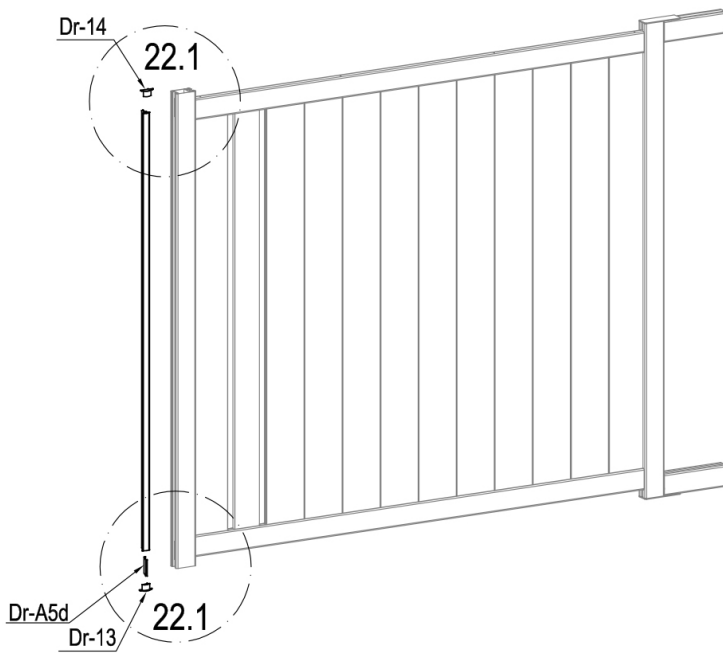

	AT-29	2
	AT-A11a	2
	AT-31	2

	AT-10	2
	LR-V30	2

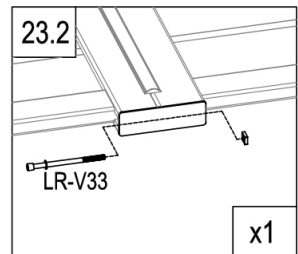
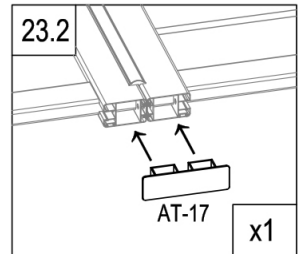
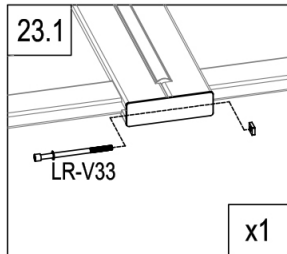
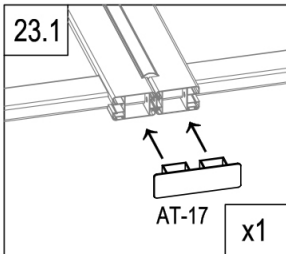
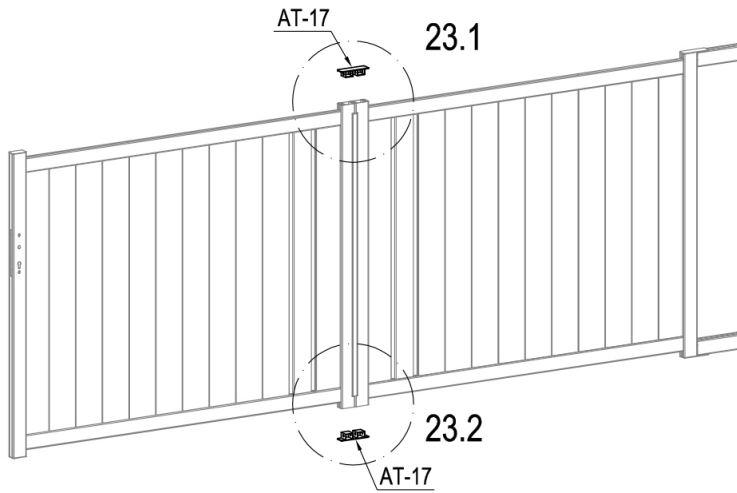

	AT-A7a	1
	Dr-A5d	1
	Dr-13	1
	Dr-14	1



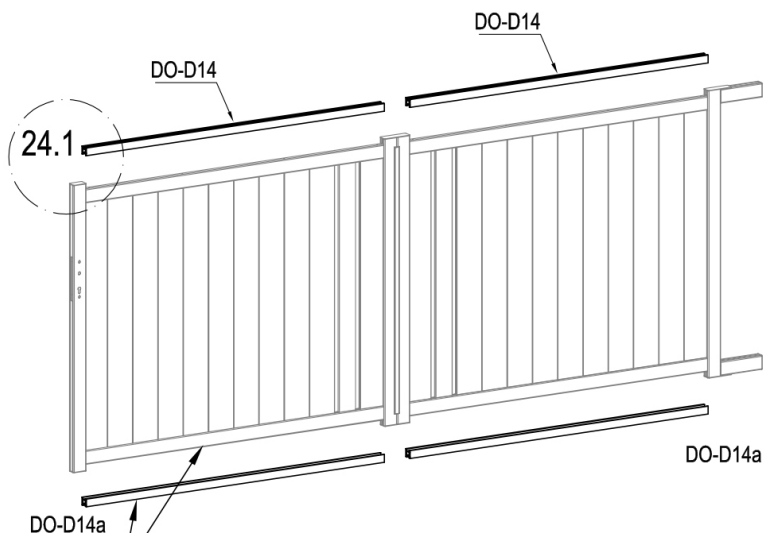

	AT-17	2
	LR-V33	2



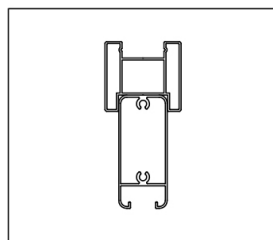
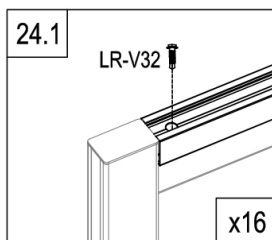
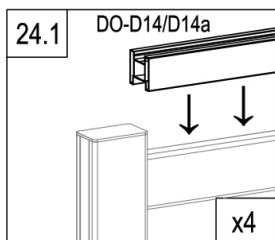

EN: These parts are made for connecting your gate's automation
 FR: Ces pièces sont faites pour relier l'automatisation de votre portail
 DE: Diese Teile sind für den Anschluss der Automatisierung Ihres Tores vorgesehen
 ES: Estas piezas están hechas para conectar la automatización de su puerta
 PT: Estas peças são feitas para ligar a automatização do seu portão
 IT: Queste parti sono realizzate per collegare l'automazione del vostro cancello
 NL: Deze onderdelen zijn gemaakt voor het aansluiten van de automatisering van uw poort.
 PL: Te części są wykonane do podłączenia automatyki bramy.



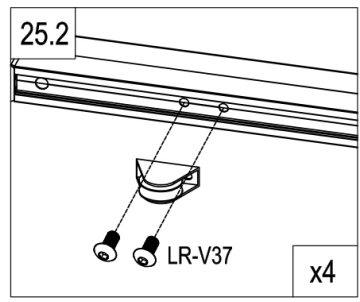
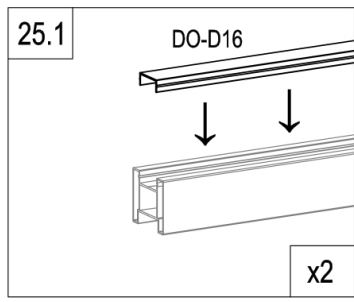
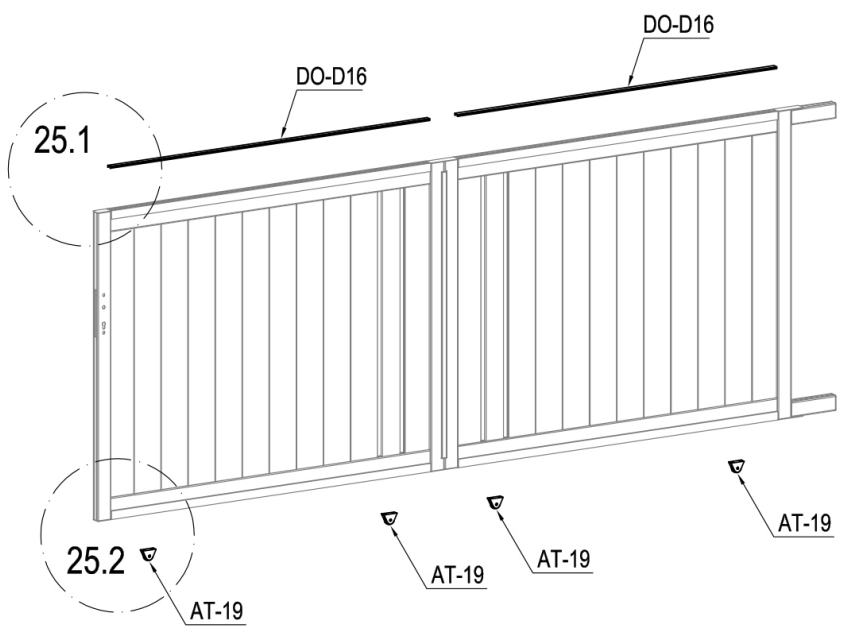

	DO-D14	2
	DO-D14a	2
	LR-V32	16

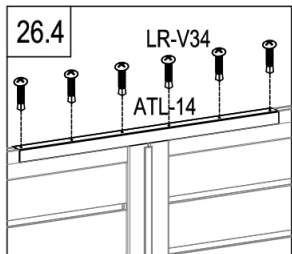
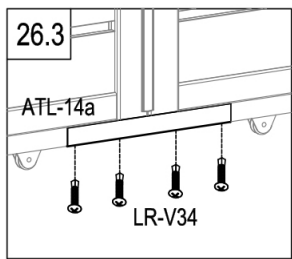
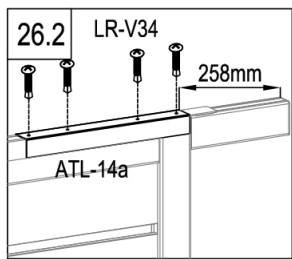
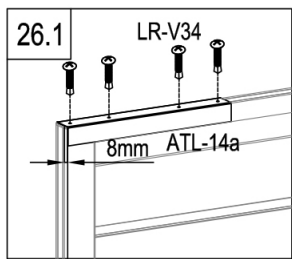
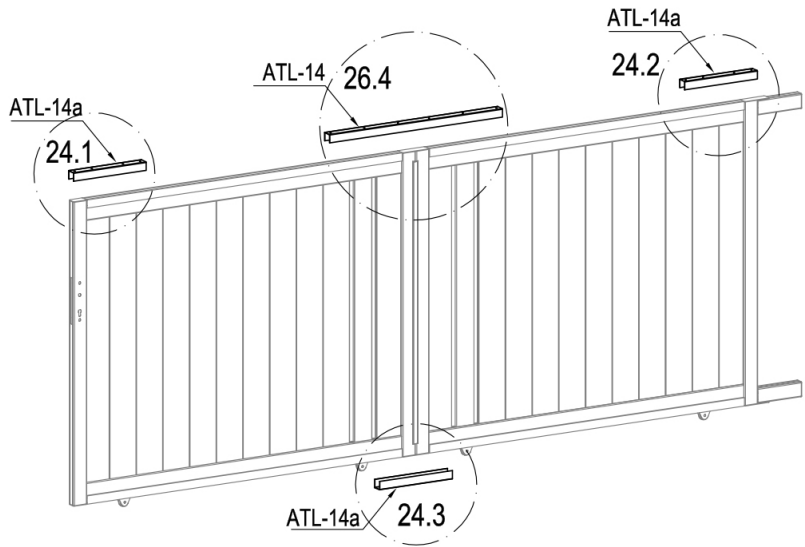

	DO-D16	2
	AT-19	4
	LR-V37	8



	ATL-14	1
	ATL-14a	3
	LR-V34	18

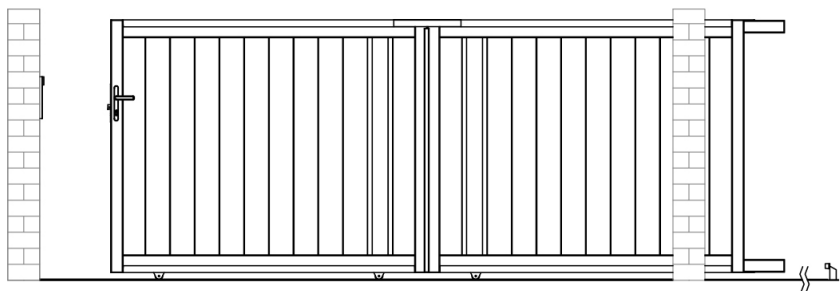

L : P27~32

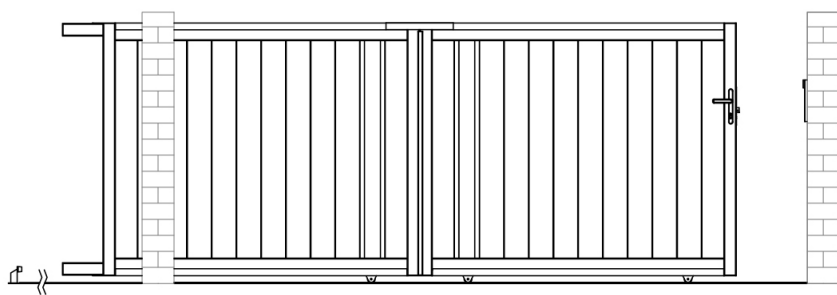

R : P33~38

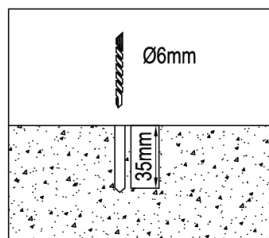
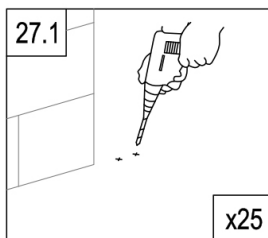
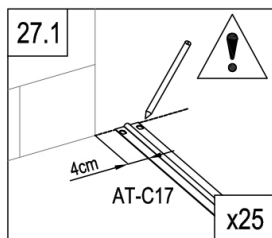
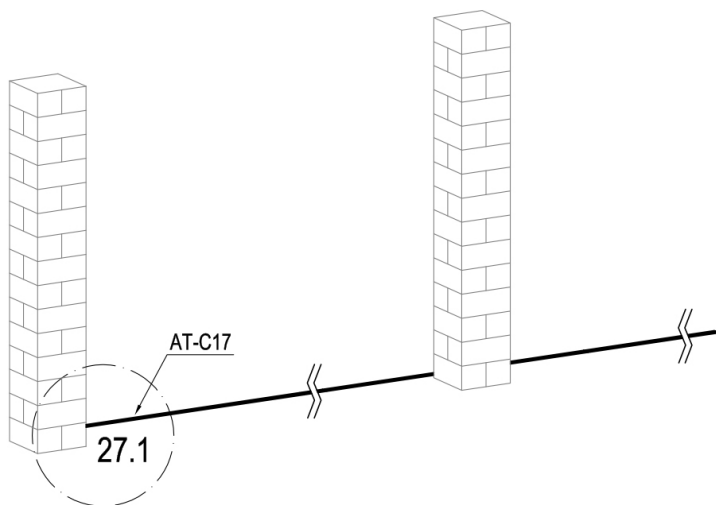

	AT-C17	5
	LR-V38	50

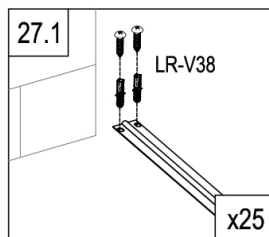

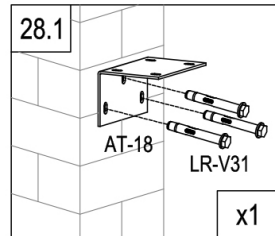
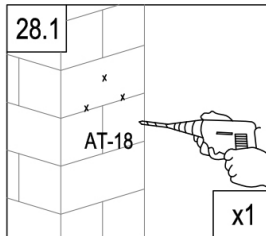
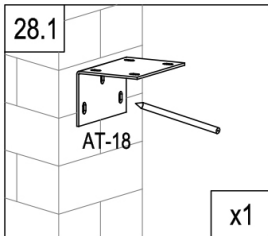
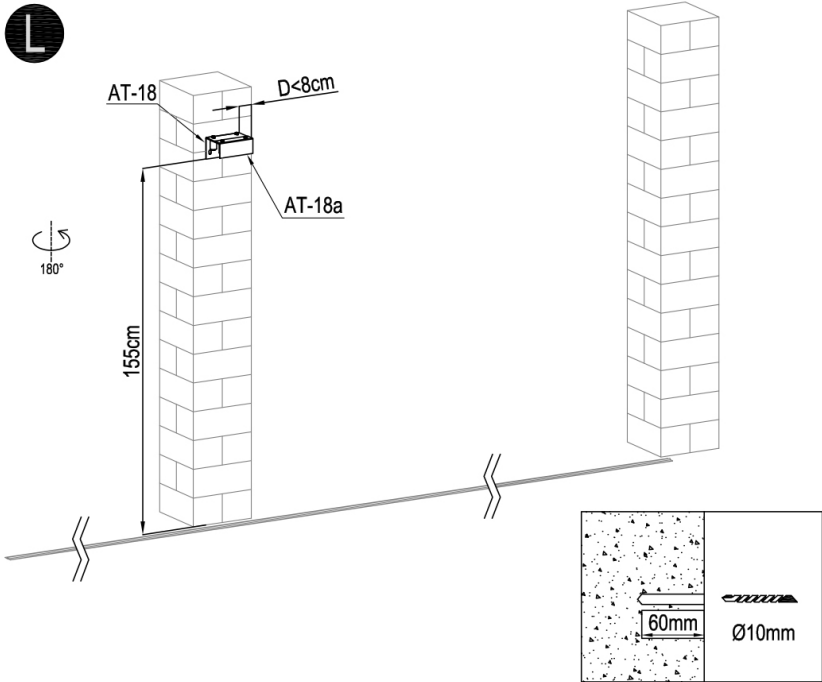

	AT-18	1
	AT-18a	1
	AT-20	4
	LR-V31	3

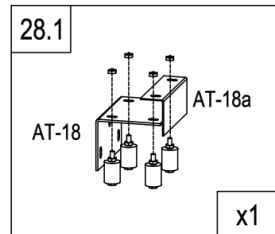
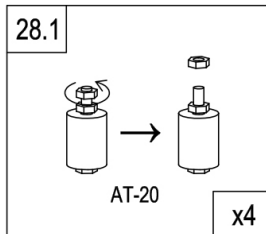

L

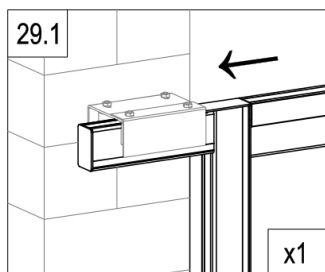
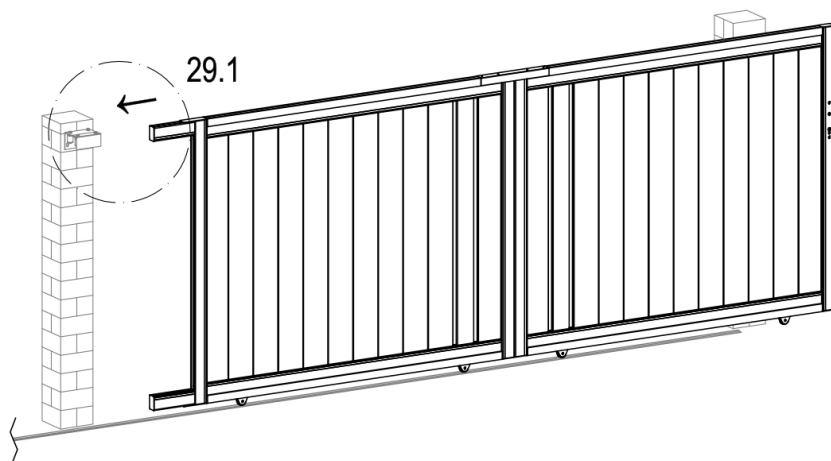

L

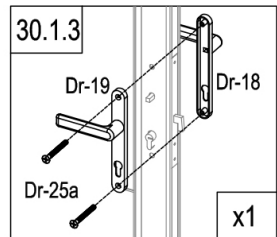
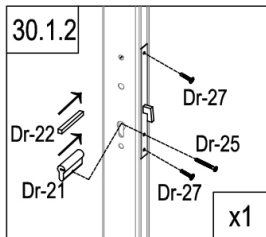
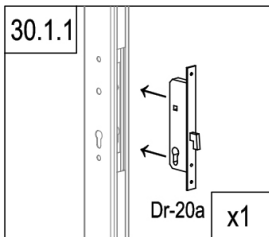
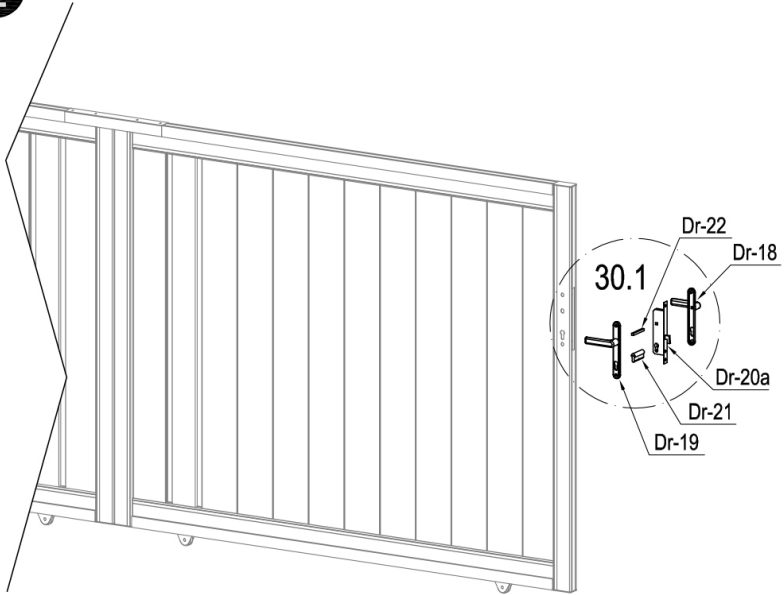

	Dr-20a	1
	Dr-21	1
	Dr-22	1
	Dr-25	1

	Dr-18	1
	Dr-19	1
	Dr-25a	2
	Dr-27	2

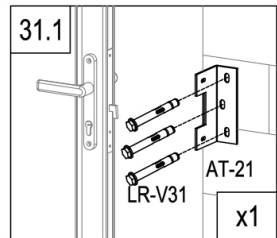
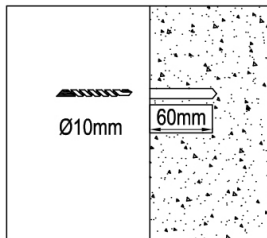
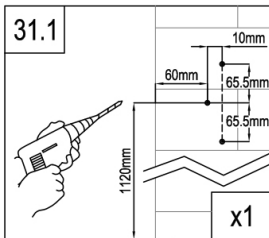
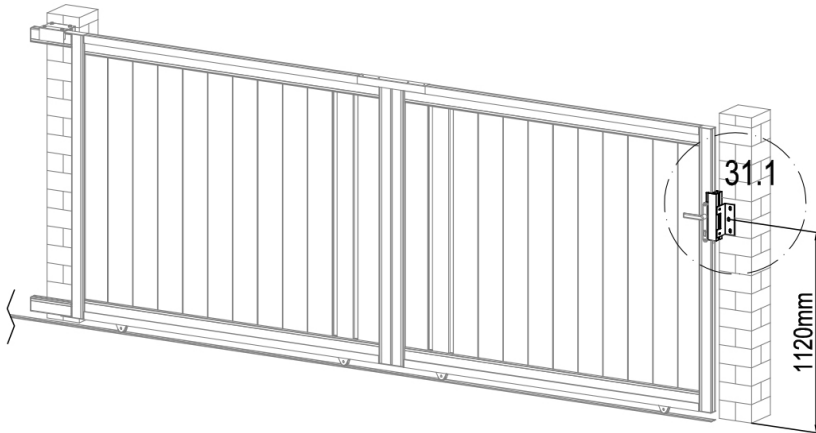

	AT-16	1
	AT-21	1
	LR-V36	2
	LR-V31	3
	AT-22J	3

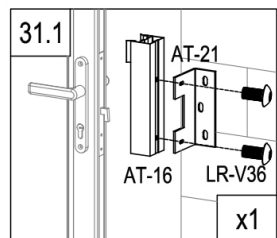
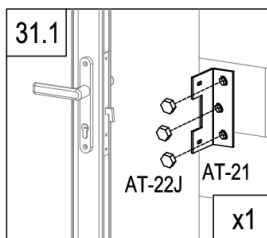

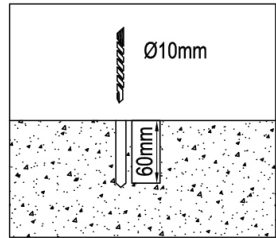
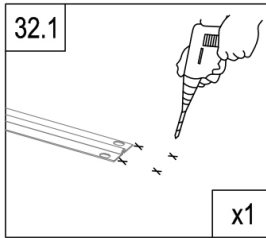
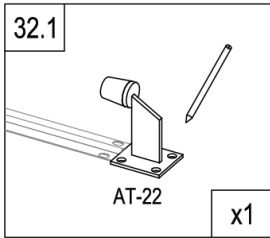
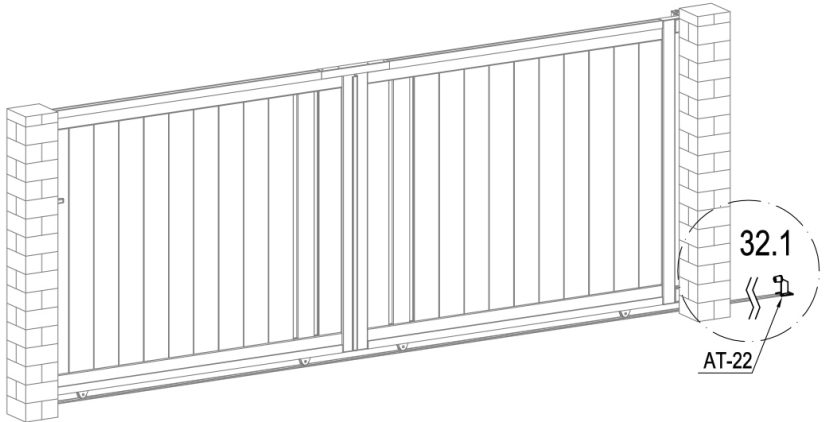

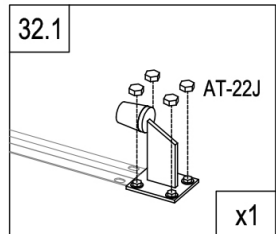
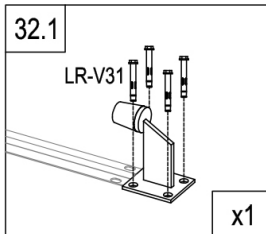

	AT-22	1
	LR-V31	4
	AT-22J	4

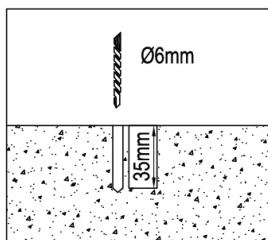
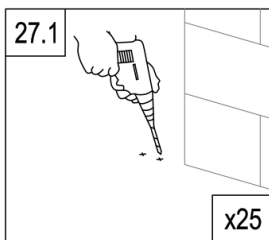
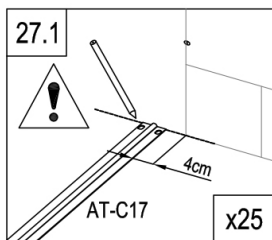
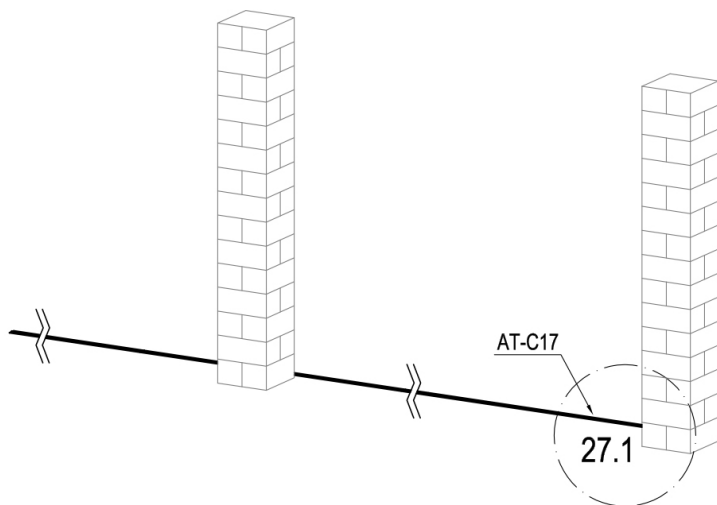

R



	AT-C17	5
	LR-V38	50

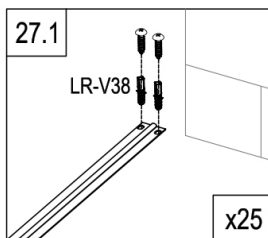

R

180°

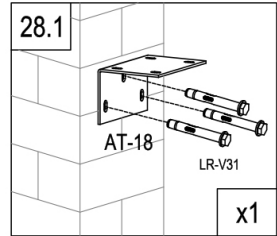
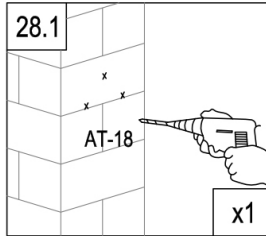
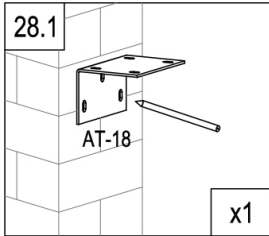
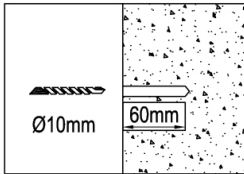
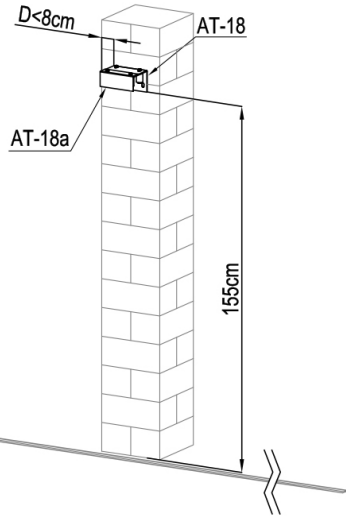

	AT-18	1
	AT-18a	1
	AT-20	4
	LR-V31	3

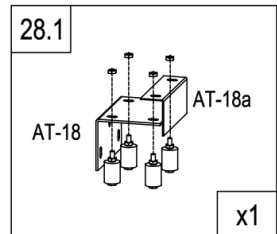
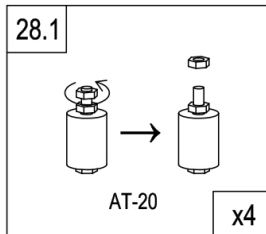

R

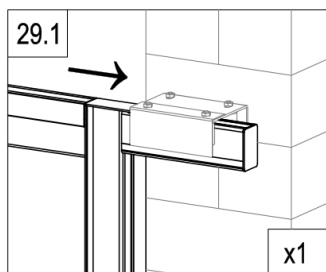
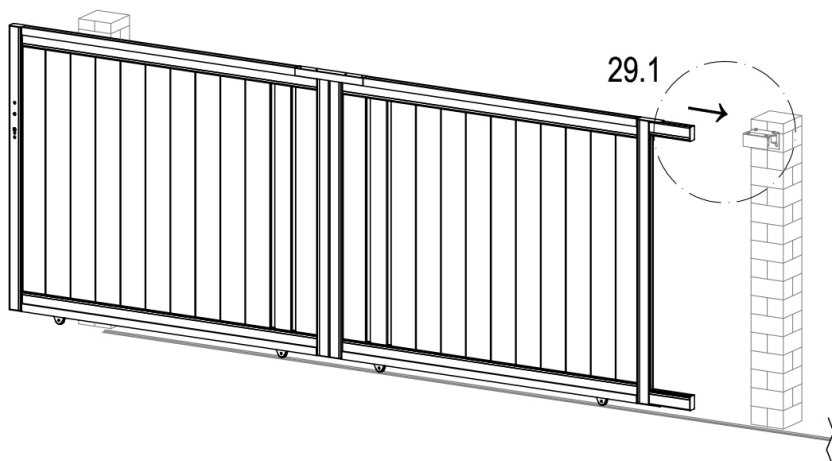

R

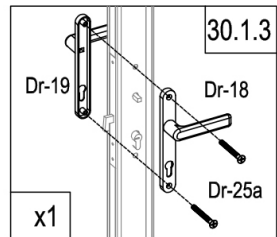
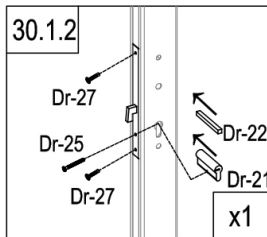
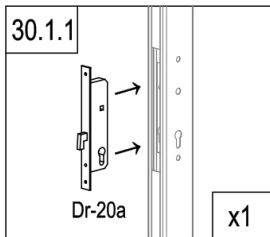
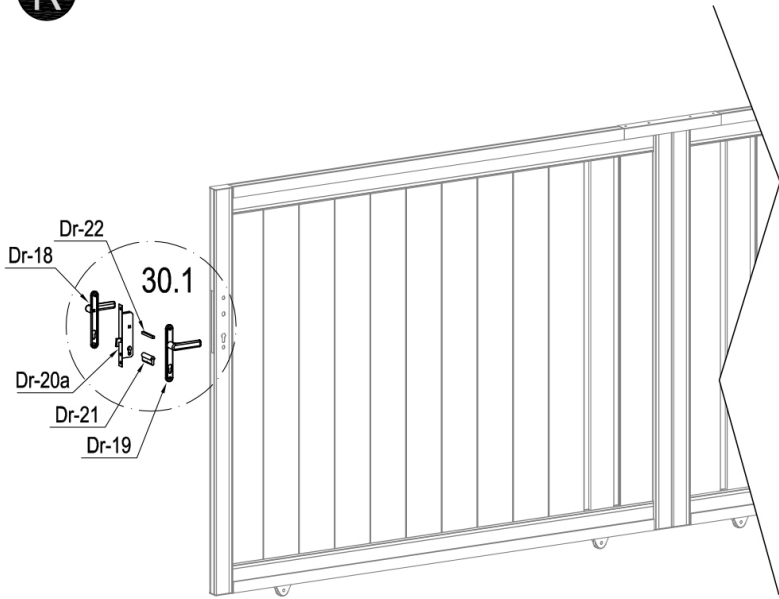

	Dr-20a	1
	Dr-21	1
	Dr-22	1
	Dr-25	1

	Dr-18	1
	Dr-19	1
	Dr-25a	2
	Dr-27	2

R

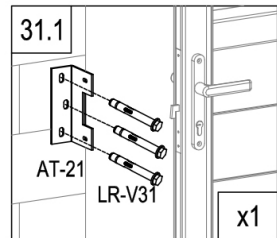
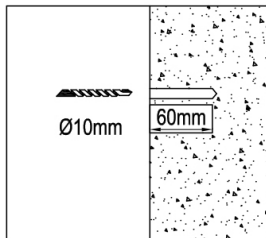
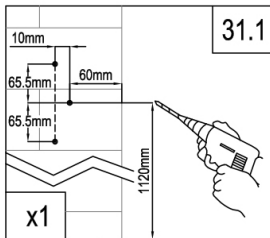
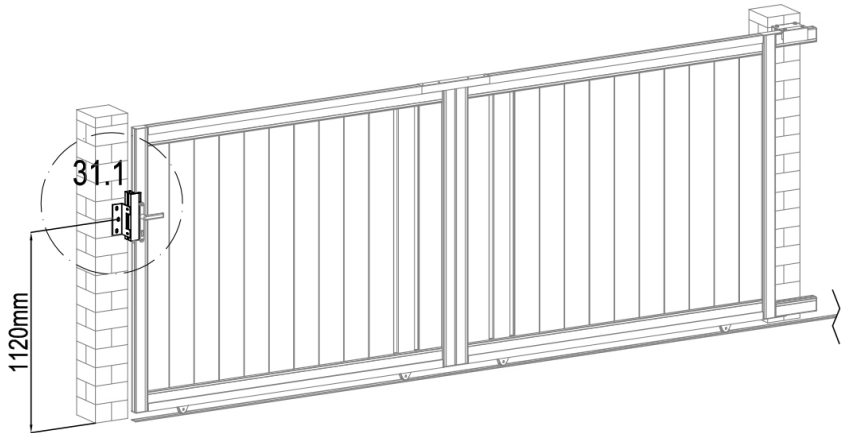

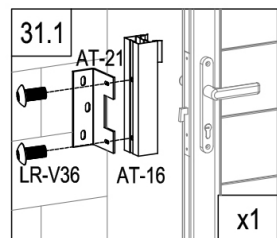
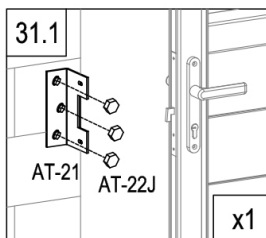

	AT-16	1
	AT-21	1
	LR-V36	2
	LR-V31	3
	AT-22J	3

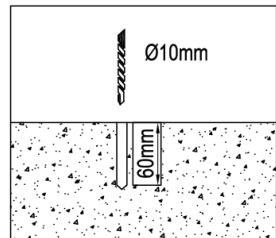
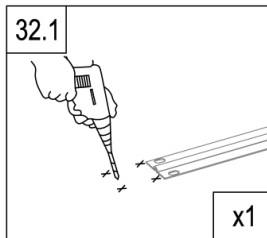
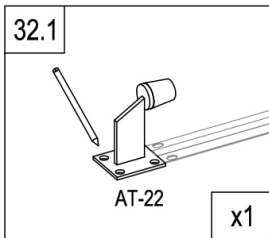
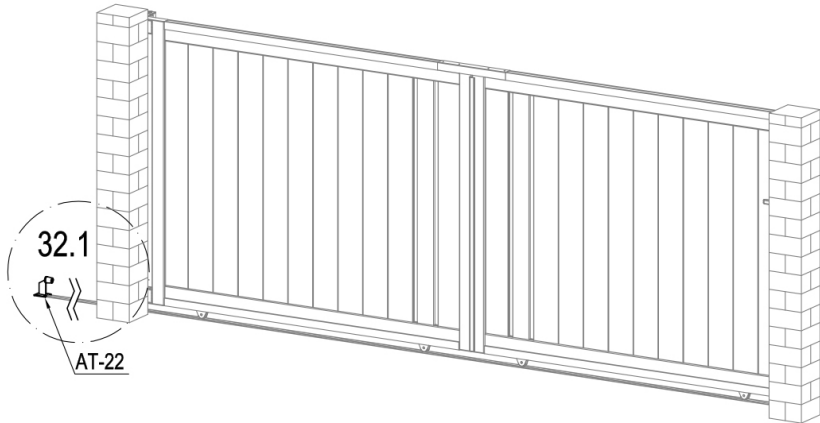

R



	AT-22	1
	LR-V31	4
	AT-22J	4

