

# CASANOVO

## VEYMONT 300C140

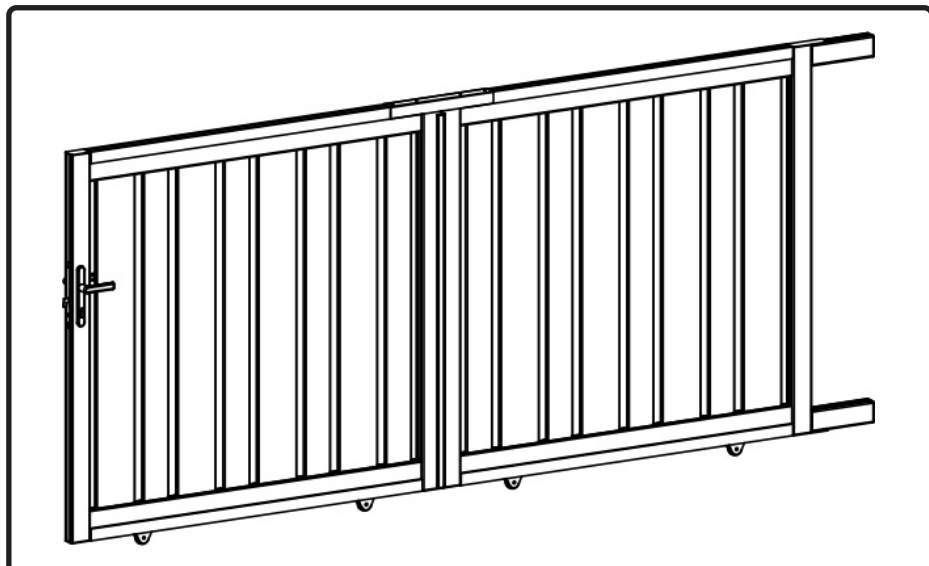

COM-000839 [x1]

COM-000812 [x1]

COM-000840 [x1]



INSTRUCTION MANUAL / NOTICE DE MONTAGE / MONTAGEANLEITUNG / MANUAL DE MONTAJE / MANUAL DE MONTAGEM / MANUALE DI MONTAGGIO /  
MONTAGEHANDLEIDING / INSTRUKCJA MONTAŻU / KÄYTTÖOHJEET / BRUKSANVISNING / BRUGSANVISNING / INSTRUCIUNI DE ASAMBLARE /  
NAVODILA ZA SESTAVLJANJE / NÁVOD NA MONTÁŽ / ÖSSZESZERELÉSI ÚTMUTATÓ / NÁVOD K MONTÁŽI / UPUTE ZA INSTALACIJU /  
ΟΔΗΓΙΕΣ ΣΥΝΑΡΜΟΛΟΓΗΣΗΣ / SURINKIMO INSTRUKCIJOS / MONTĀŽAS INSTRUKCIJAS

Ext.

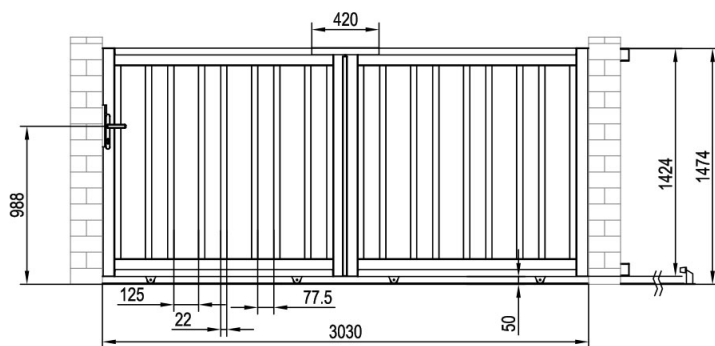

Int.

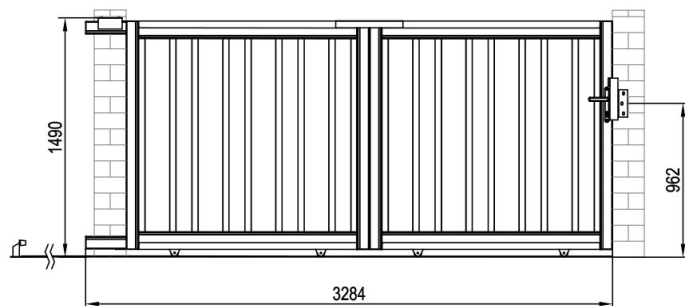

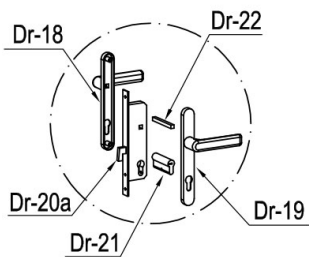
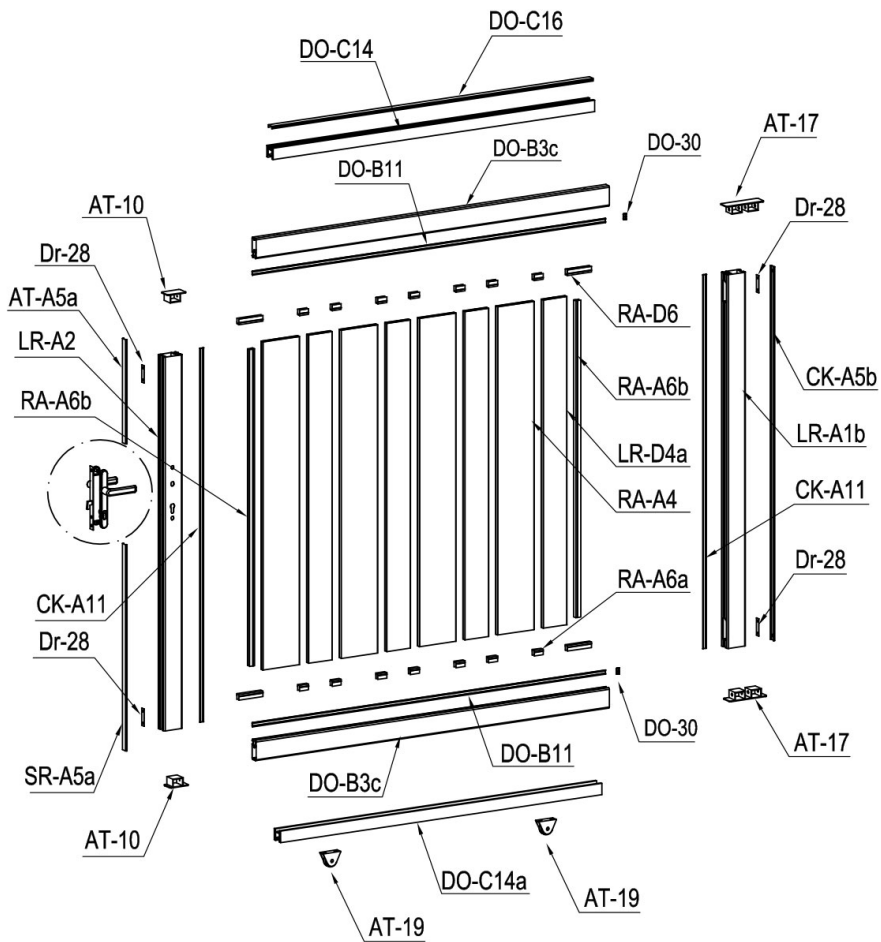

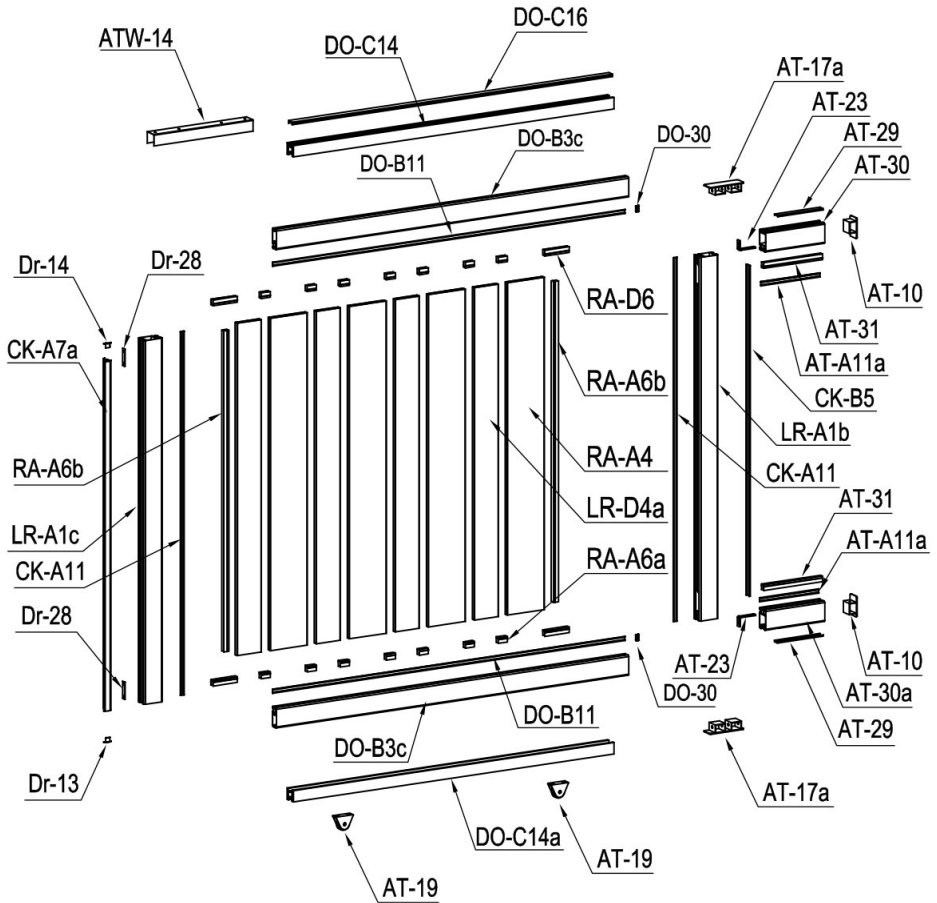

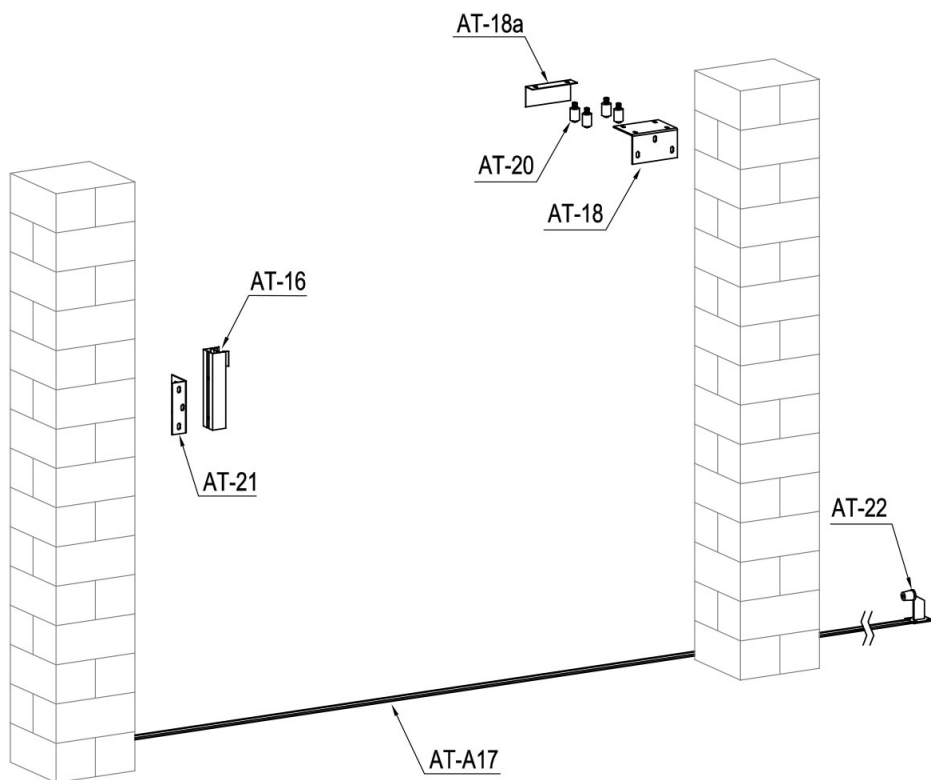















































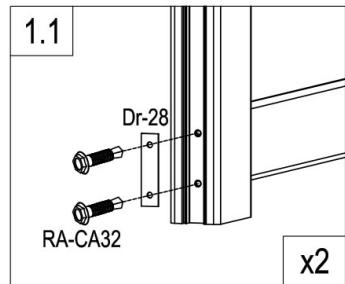
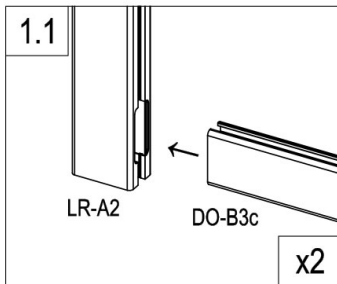
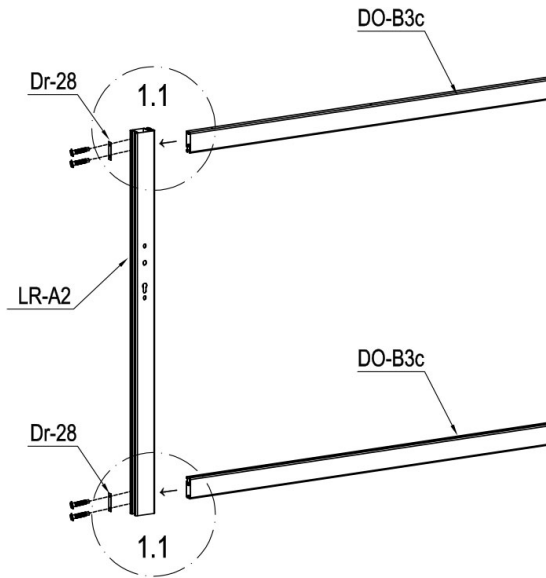

## PART LIST

IMAGE	NO.	L.(mm)	QTY	IMAGE	NO.	L.(mm)	QTY
	LR-A1b	1418	2		Dr-14		1
	LR-A1c	1418	1		DO-30		4
	LR-A2	1418	1		AT-18	150	1
	AT-30	250	1		AT-18a	150	1
	AT-30a	250	1		ATW-14	420	1
	DO-B3c	1492	4		AT-19		4
	RA-A4	1245	8		AT-20		4
	LR-D4a	1245	8		AT-21		1
	CK-A5b	1418	1		AT-22		1
	CK-B5	1293	1		AT-23		2
	AT-A5a	395.5	1		Dr-18		1
	SR-A5a	782	1		Dr-19		1
	AT-29	193	2		Dr-20a		1
	CK-A11	1418	4		Dr-21		1
	AT-A11a	250	2		Dr-22		1
	DO-B11	1492	4		Dr-25	M5x45	1
	AT-31	250	2		Dr-25a	M5x60	2
	RA-A6a	38	28		Dr-27	ST4.2x25	2
	RA-A6b	1202	4		Dr-28		6
	RA-D6	102	8		AT-22J		7
	CK-A7a	1365	1		RA-CA30	ST4x10	4
	DO-C14	1358	2		RA-CA31	M8x60	10
	DO-C14a	1358	2		RA-CA32	ST5.5x38	28
	DO-C16	1357	2		RA-CA33	M8x130	4
	AT-16		1		RA-CA34	ST4.8x38	12
	AT-A17	1212	5		RA-CA35	ST4.2x19	54
	AT-17		2		RA-CA36	M6x20	2
	AT-17a		2		RA-CA37	M8x20	8
	AT-10		4		RA-CA38	M4x25	40
	Dr-13		1				





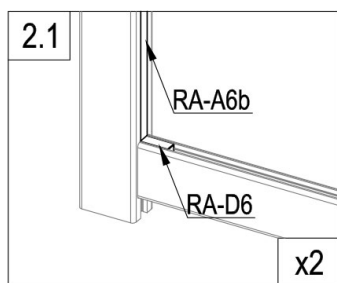
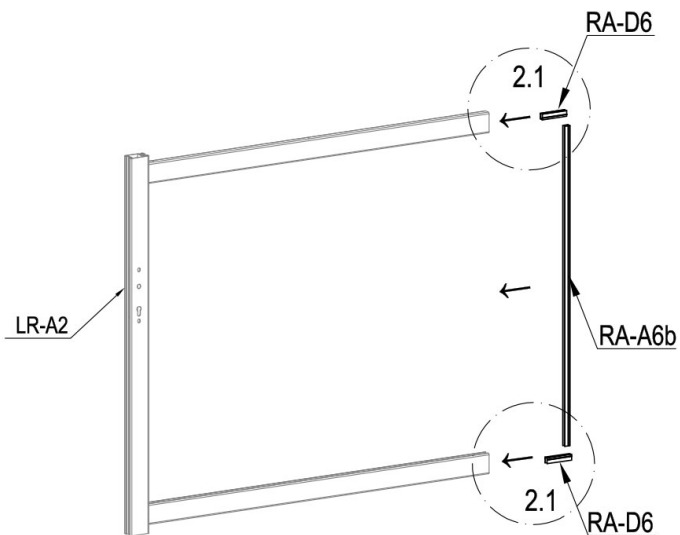

	LR-A2	1
	DO-B3c	2
	Dr-28	2
	RA-CA32	4

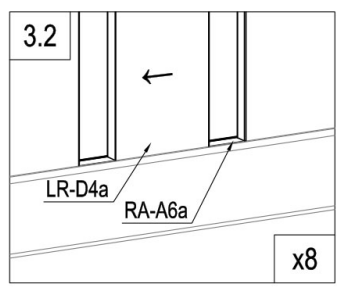
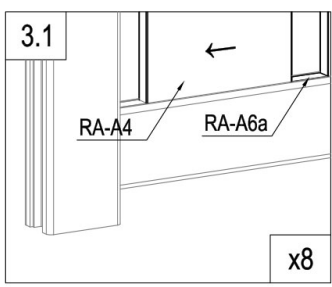
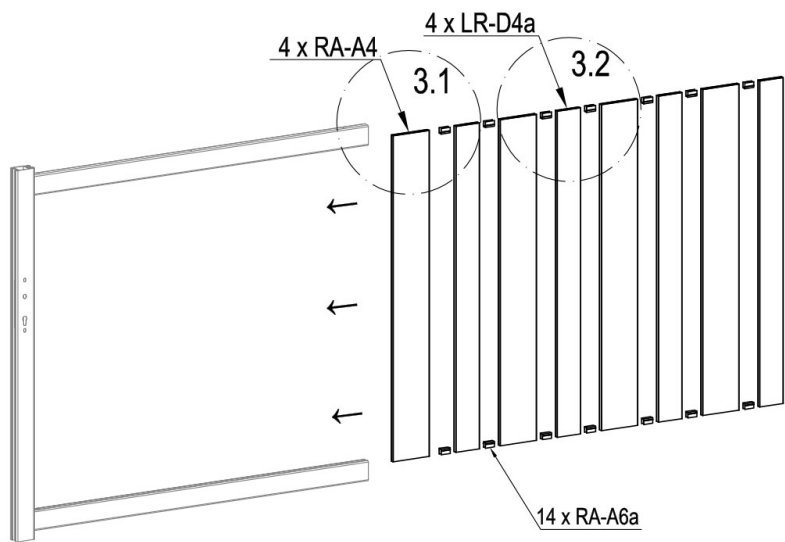

C	RA-D6	2
	RA-A6b	1







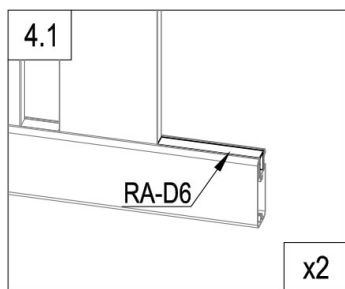
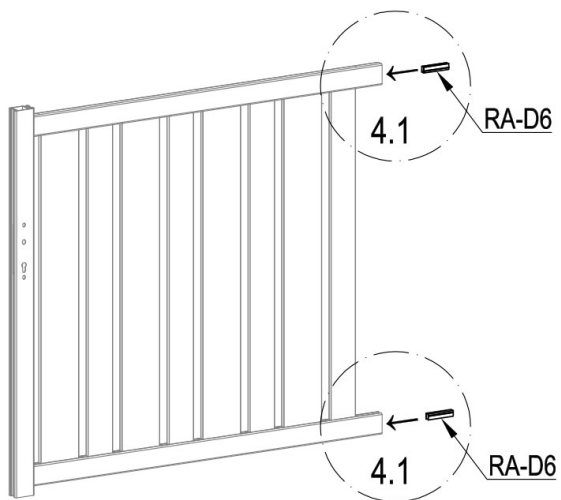

	RA-A4	4
	LR-D4a	4
	RA-A6a	14

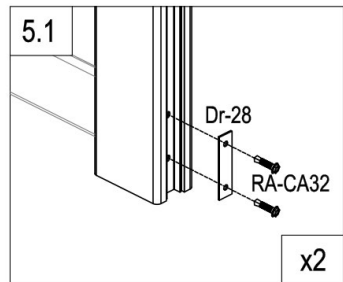
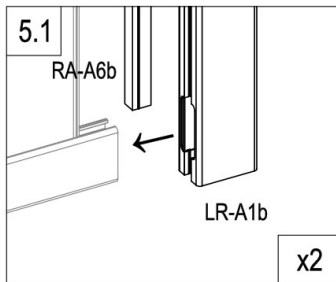
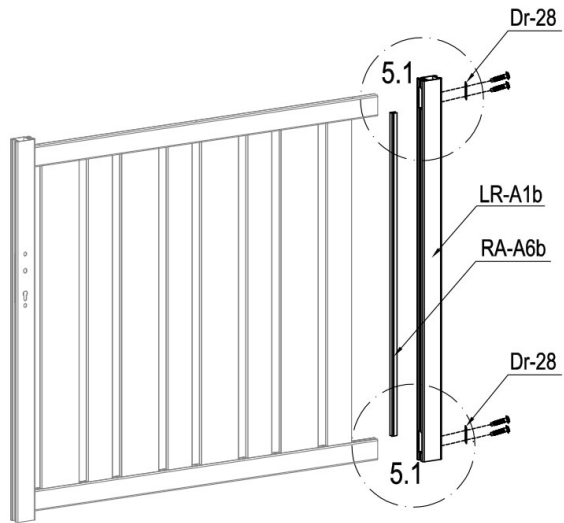



	RA-D6	2
---	-------	---

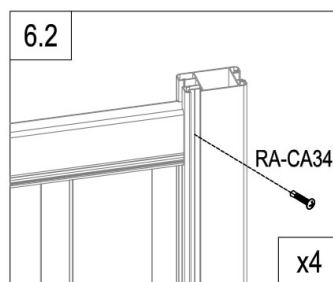
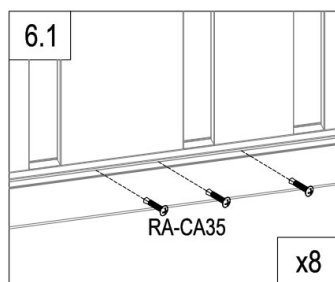
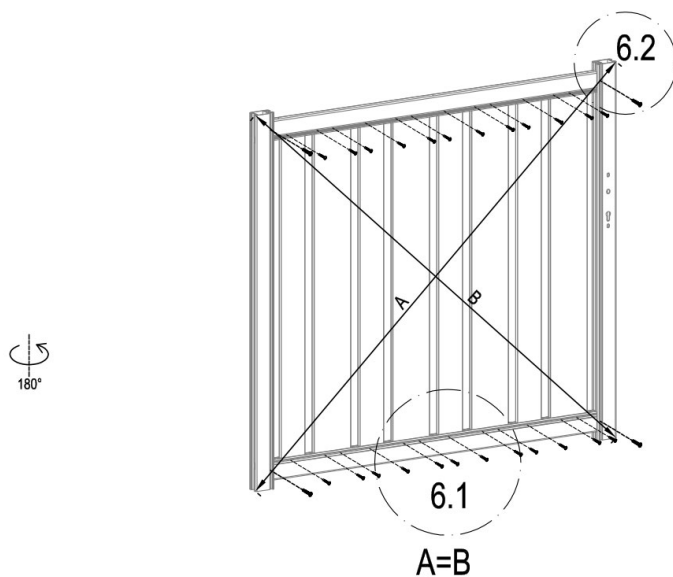

	LR-A1b	1
	RA-A6b	1
	Dr-28	2
	RA-CA32	4



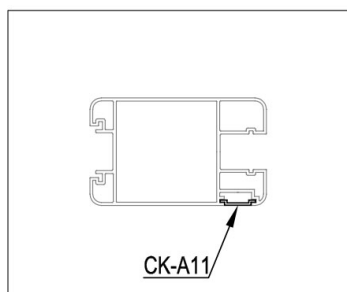
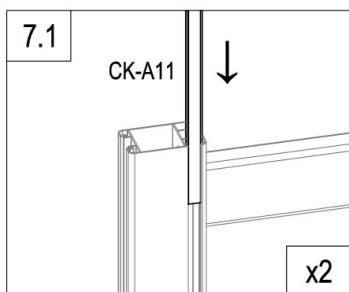
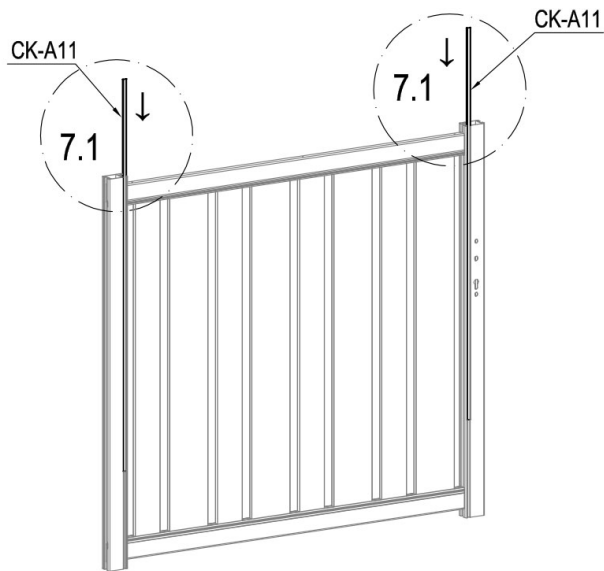

	RA-CA35	24
	RA-CA34	4

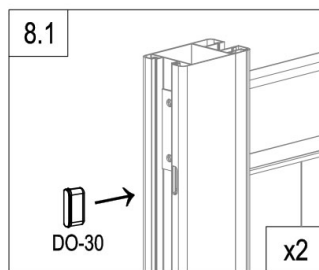
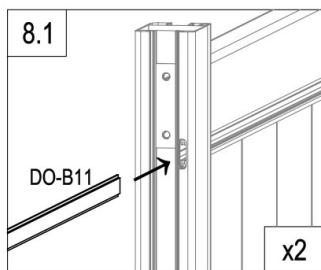
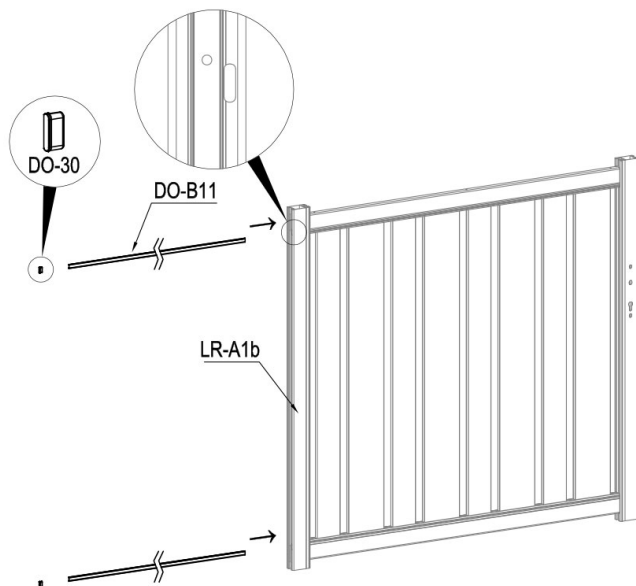

	CK-A11	2
---	--------	---



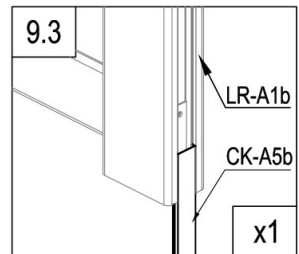
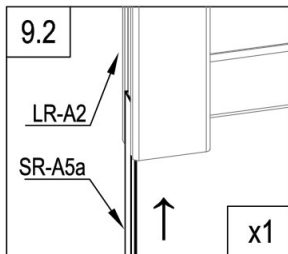
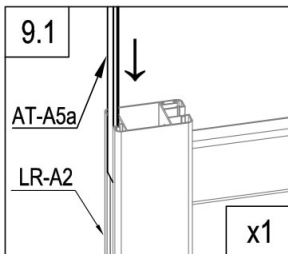
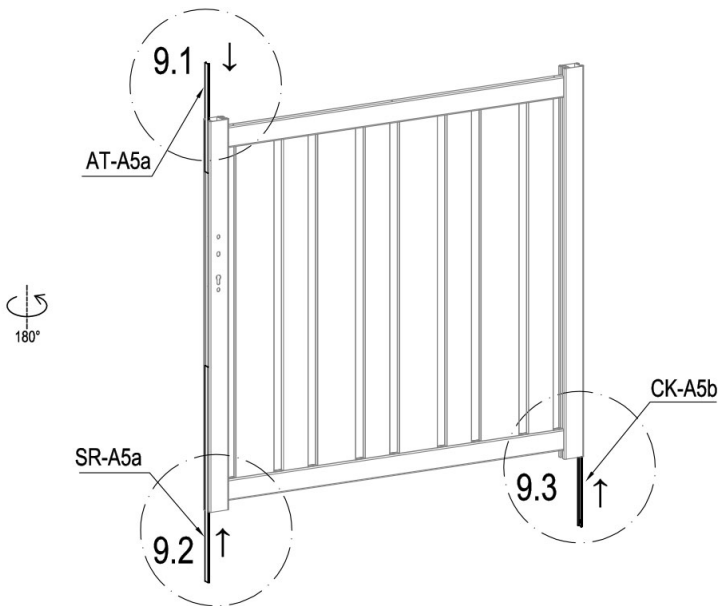

	DO-B11	2
	DO-30	2

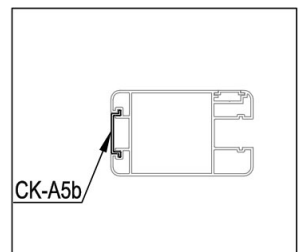

	CK-A5b	1
	AT-A5a	1
	SR-A5a	1

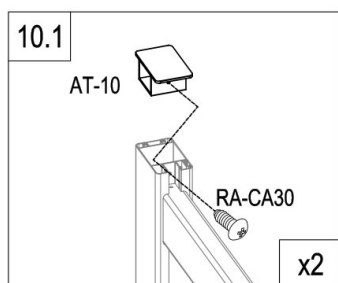
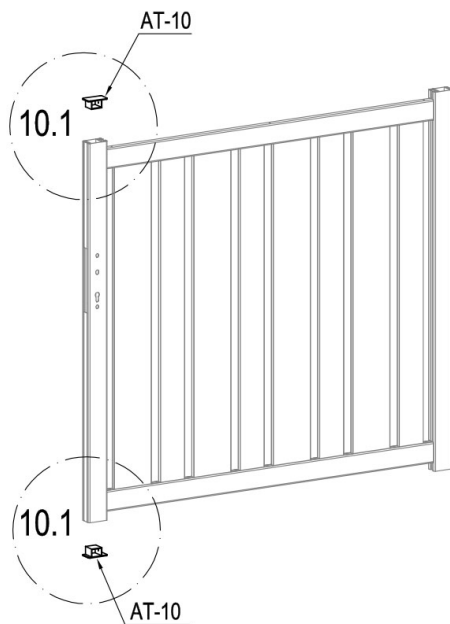





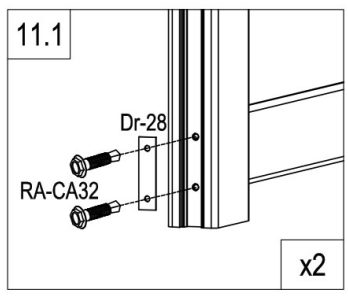
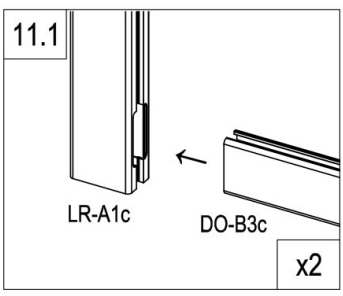
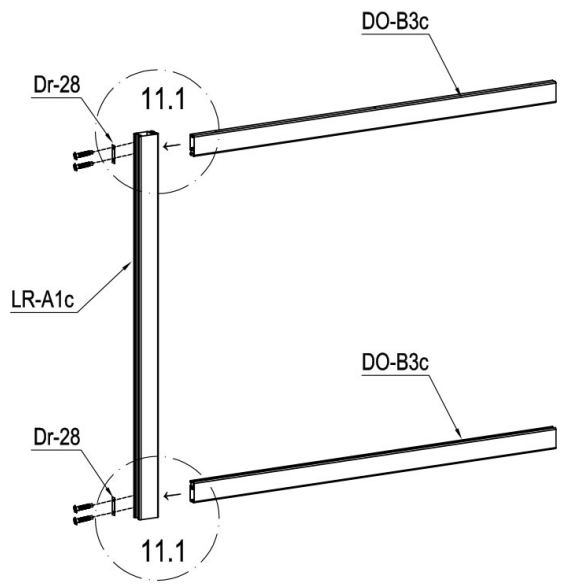

	AT-10	2
	RA-CA30	2







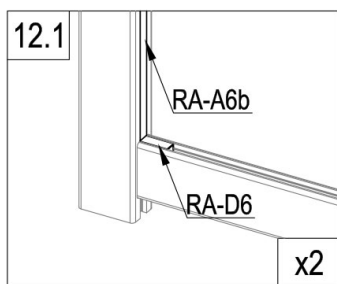
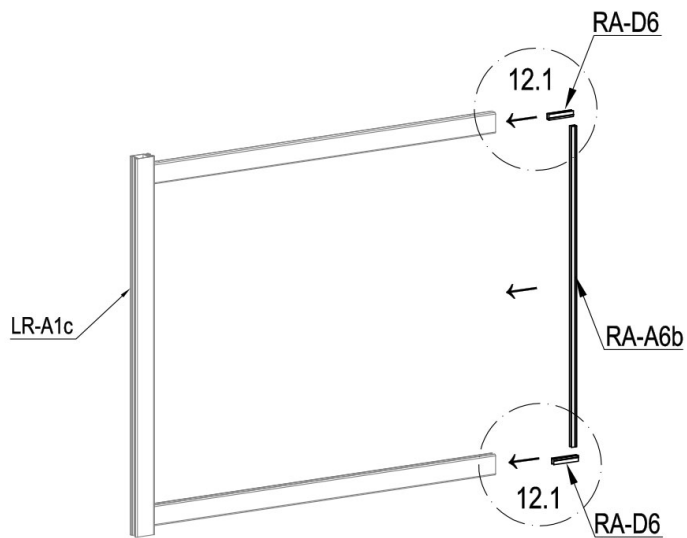

	LR-A1c	1
	DO-B3c	2
	Dr-28	2
	RA-CA33	4

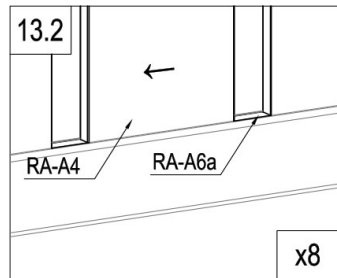
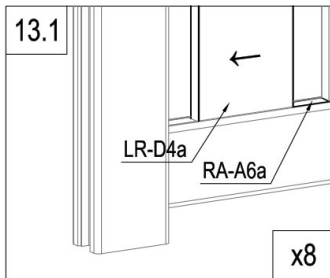
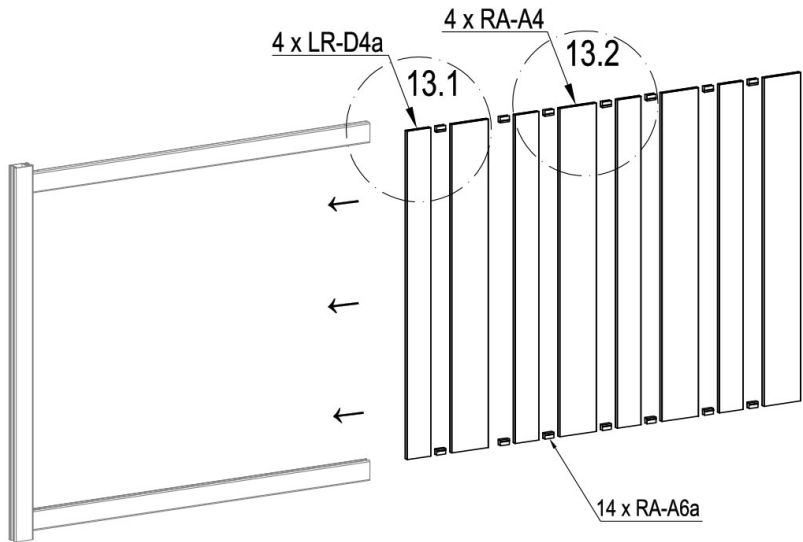

C	RA-D6	2
	RA-A6b	1



	RA-A4	4
	LR-D4a	4
	RA-A6a	14

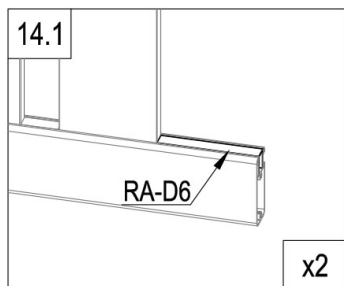
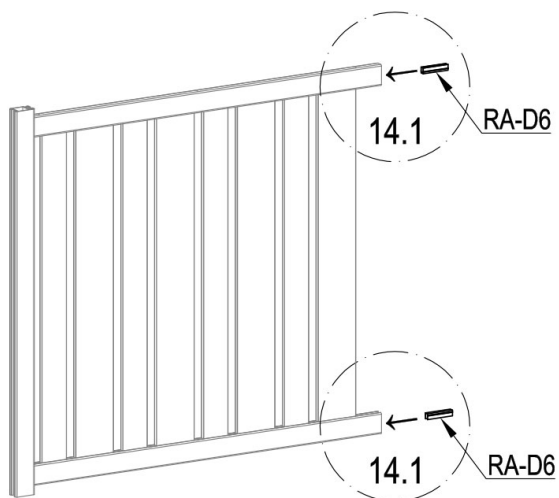

	RA-D6	2
---	-------	---

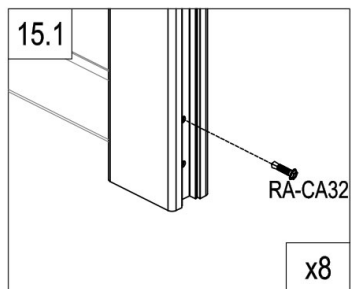
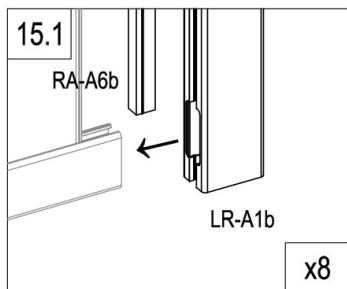
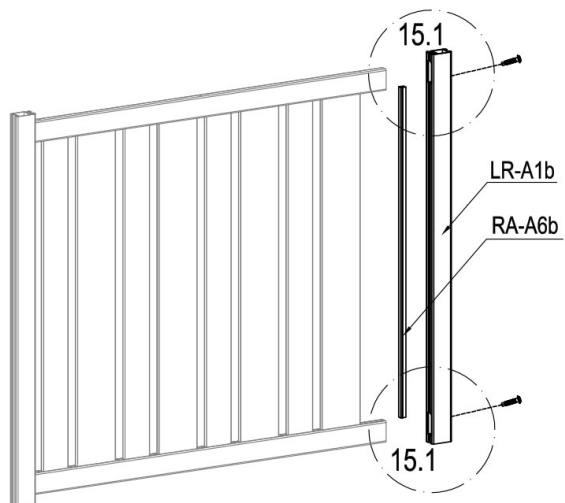

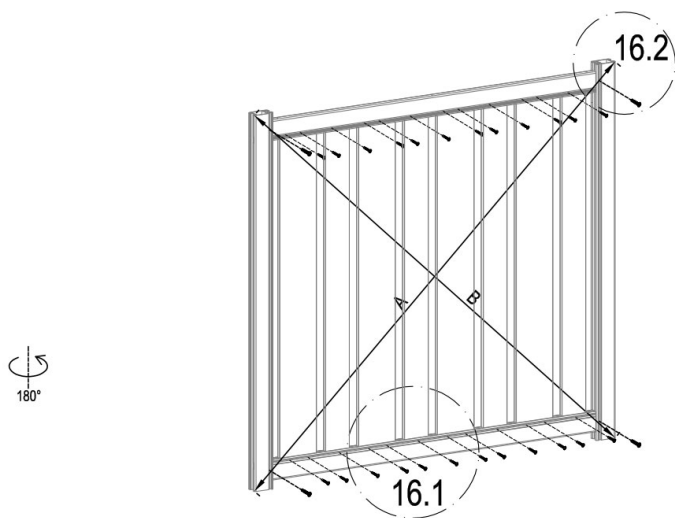

	LR-A1b	1
	RA-A6b	1
	RA-CA32	2

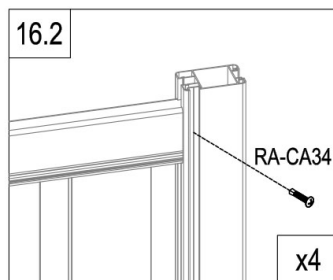
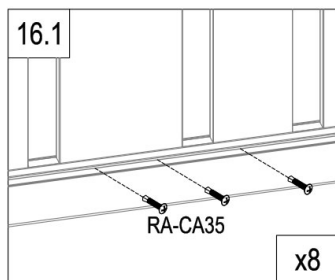

A=B



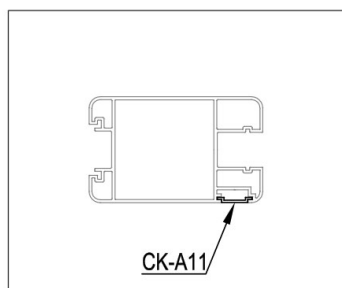
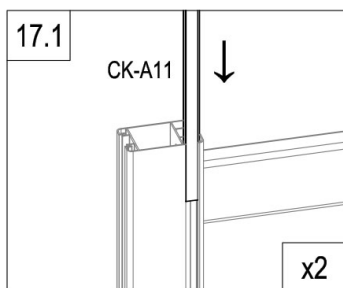
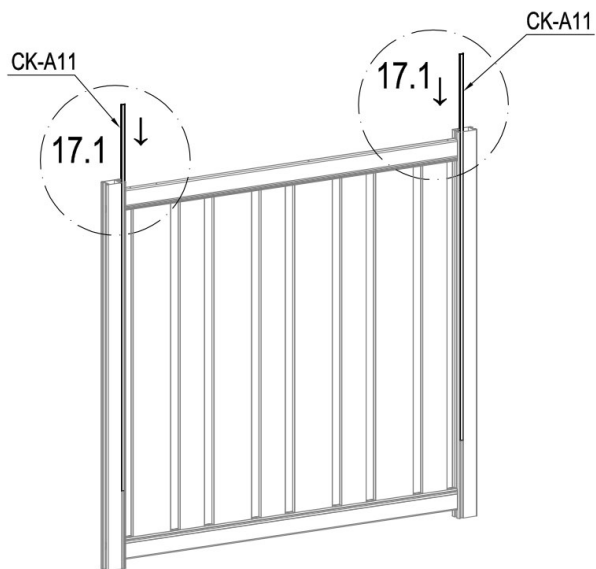

	RA-CA35	24
	RA-CA34	4



	CK-A11	2
---	--------	---

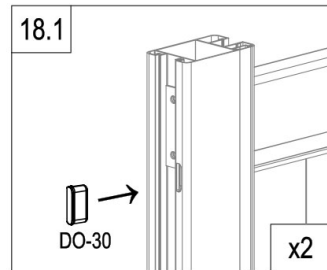
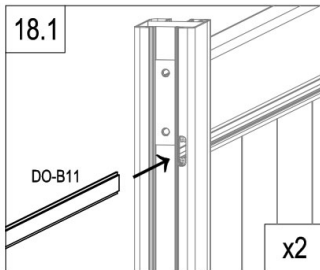
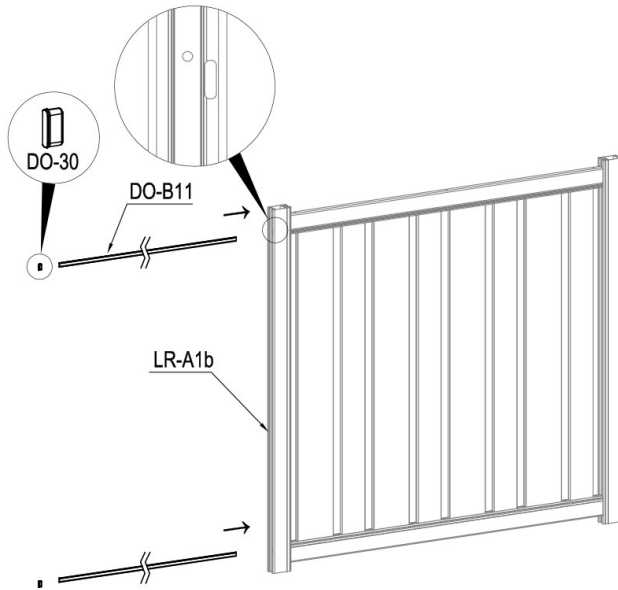



# CASANOVA



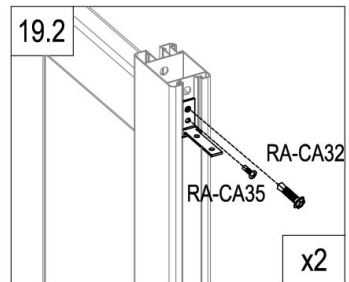
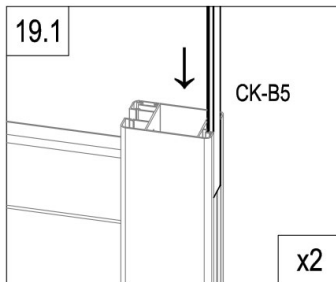
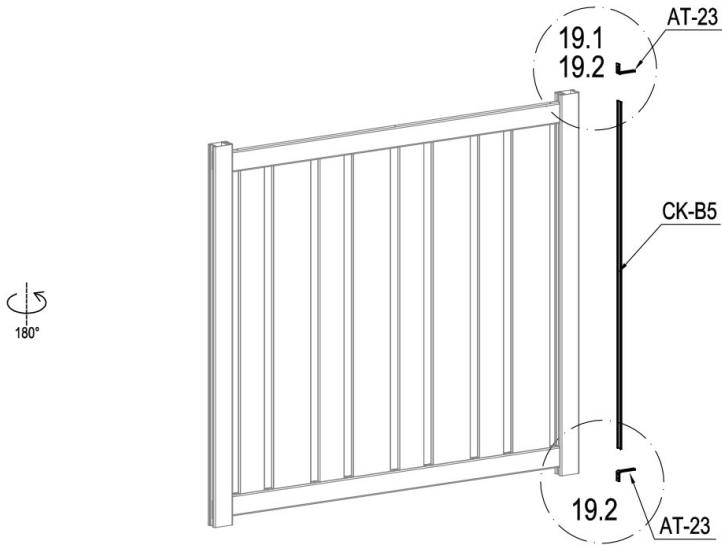

	DO-B11	2
	DO-30	2





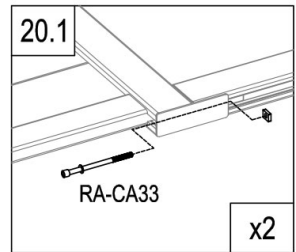
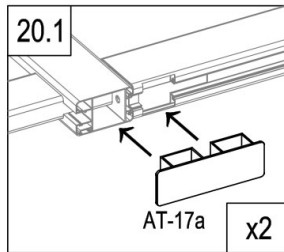
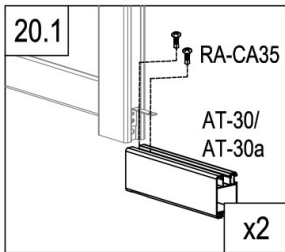
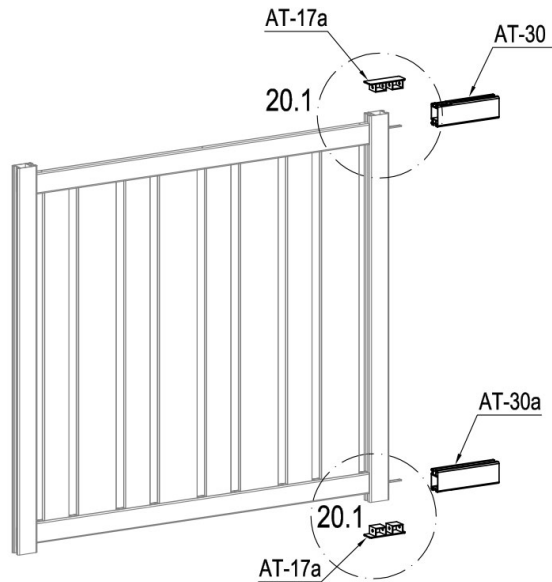

	CK-B5	1
	AT-23	2
	RA-CA32	2
	RA-CA35	2



	AT-30	1
	AT-30a	1
	AT-17a	2

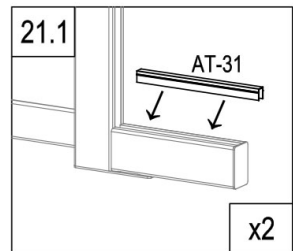
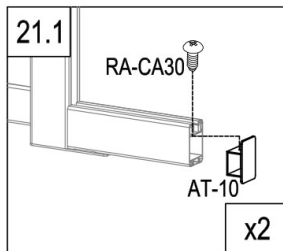
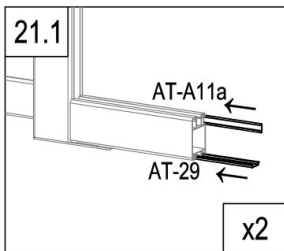
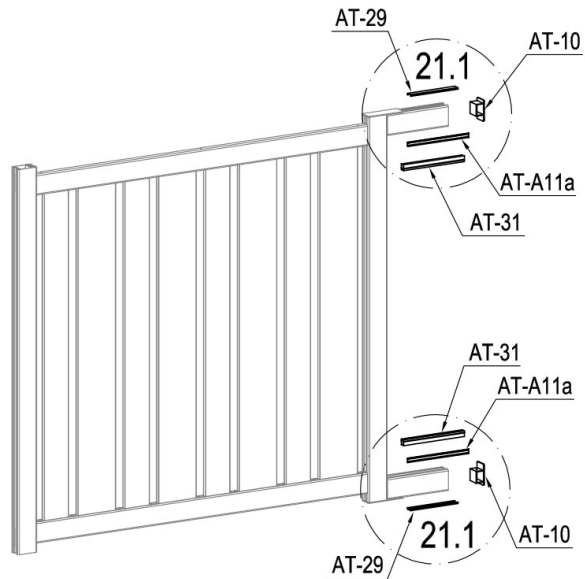

	RA-CA33	2
	RA-CA35	4



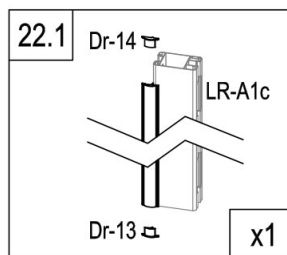
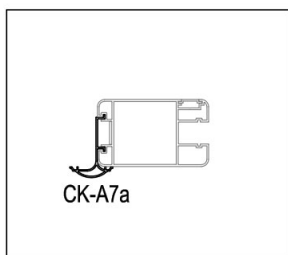
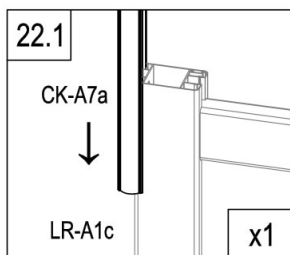
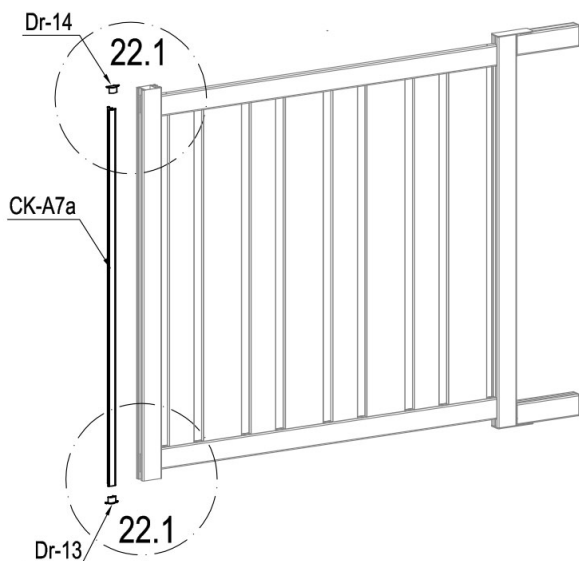

	AT-29	2
	AT-A11a	2
	AT-31	2

	AT-10	2
	RA-CA30	2

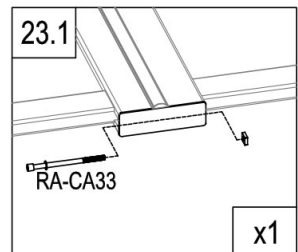
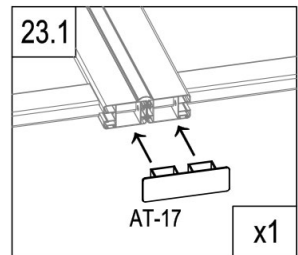
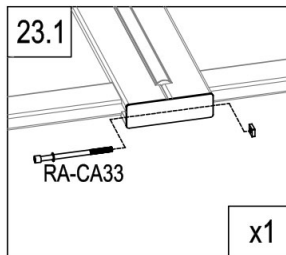
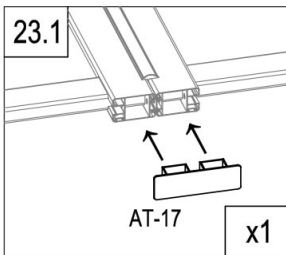
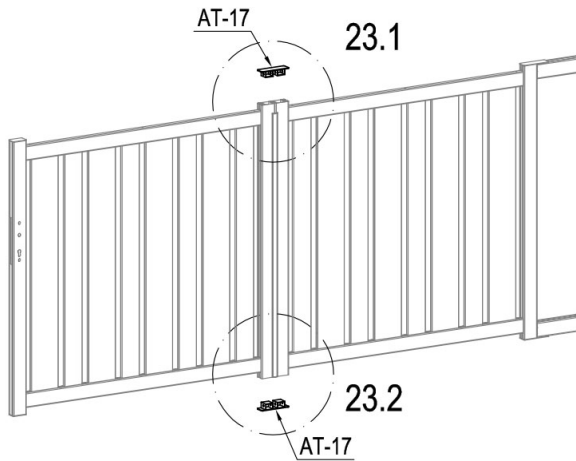

	CK-A7a	1
	Dr-13	1
	Dr-14	1



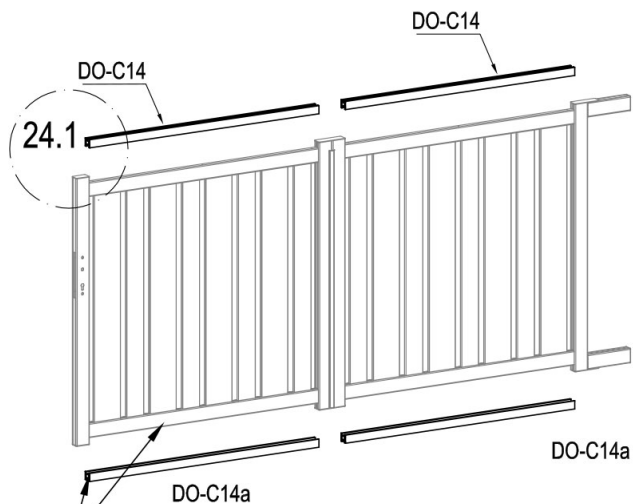

	AT-17	2
	RA-CA33	2



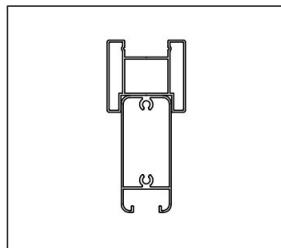
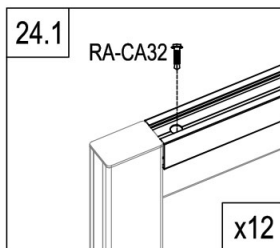
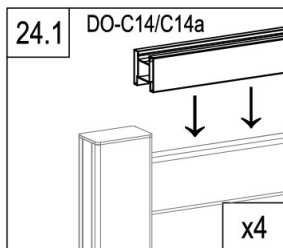

EN: These parts are made for connecting your gate's automation  
 FR: Ces pièces sont faites pour relier l'automatisation de votre portail  
 DE: Diese Teile sind für den Anschluss der Automatisierung Ihres Tores vorgesehen  
 ES: Estas piezas están hechas para conectar la automatización de su puerta  
 PT: Estas peças são feitas para ligar a automatização do seu portão  
 IT: Queste parti sono realizzate per collegare l'automazione del vostro cancello  
 NL: Deze onderdelen zijn gemaakt voor het aansluiten van de automatisering van uw poort.  
 PL: Te części są wykonane do podłączenia automatyki bramy.



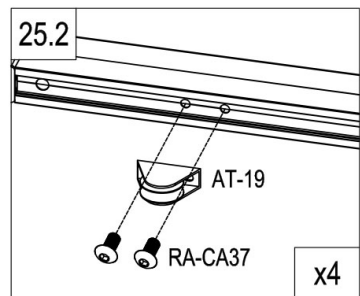
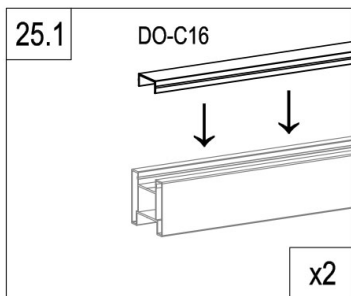
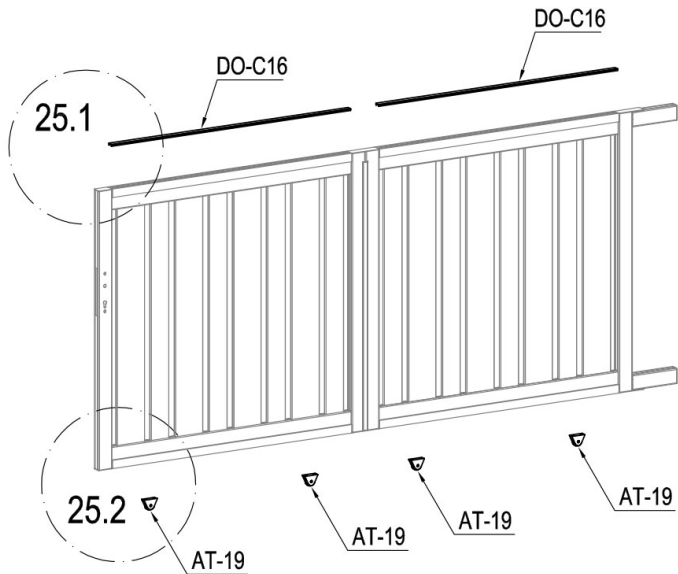

	DO-C14	2
	DO-C14a	2
	RA-CA32	12

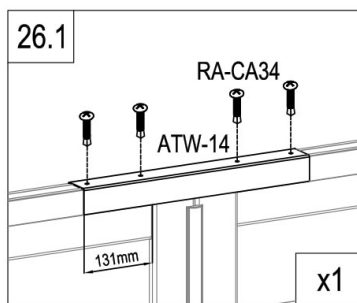
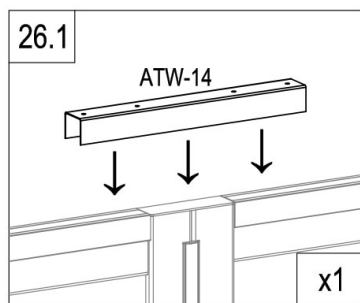
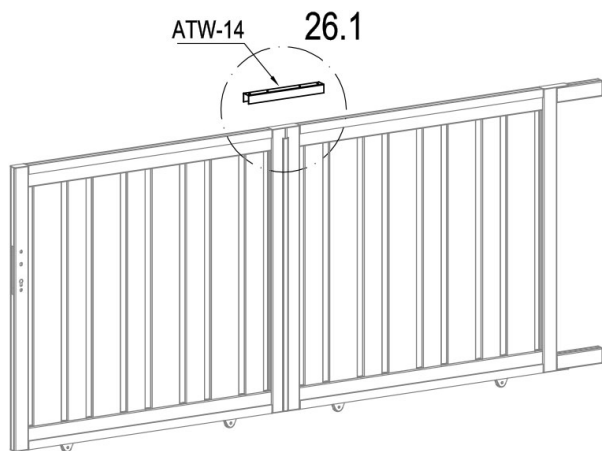

	DO-C16	2
	AT-19	4
	RA-CA37	8



	ATW-14	1
	RA-CA34	4



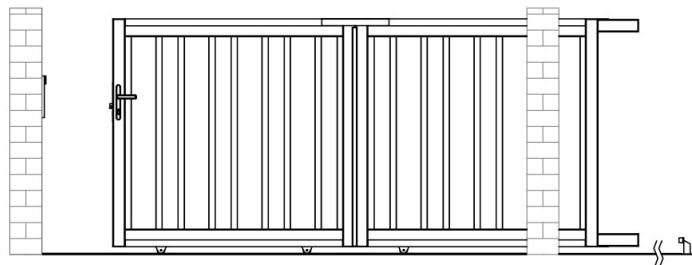

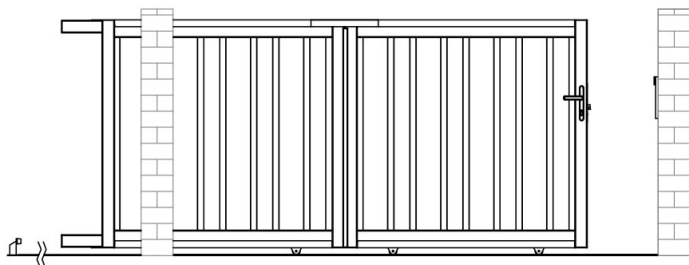

**L** : P27~32

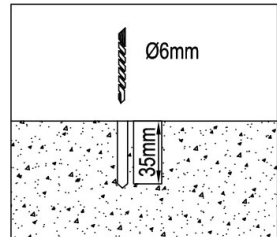
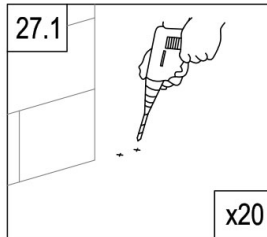
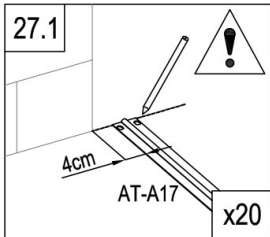
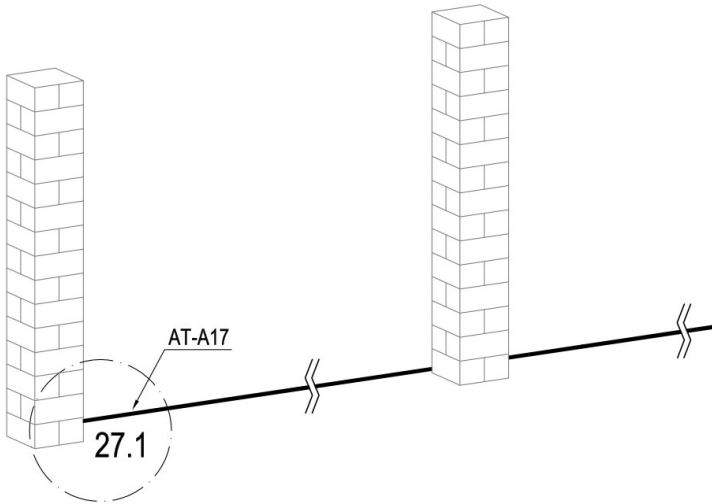

**R** : P33~38

L



	AT-A17	5
	RA-CA38	40

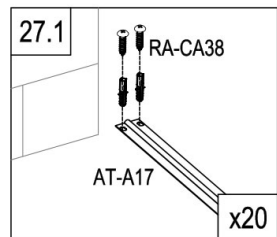

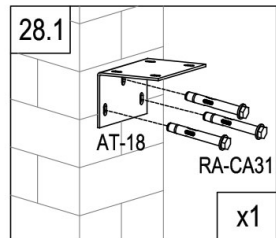
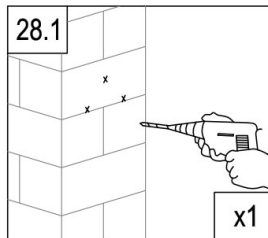
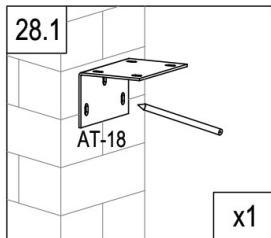
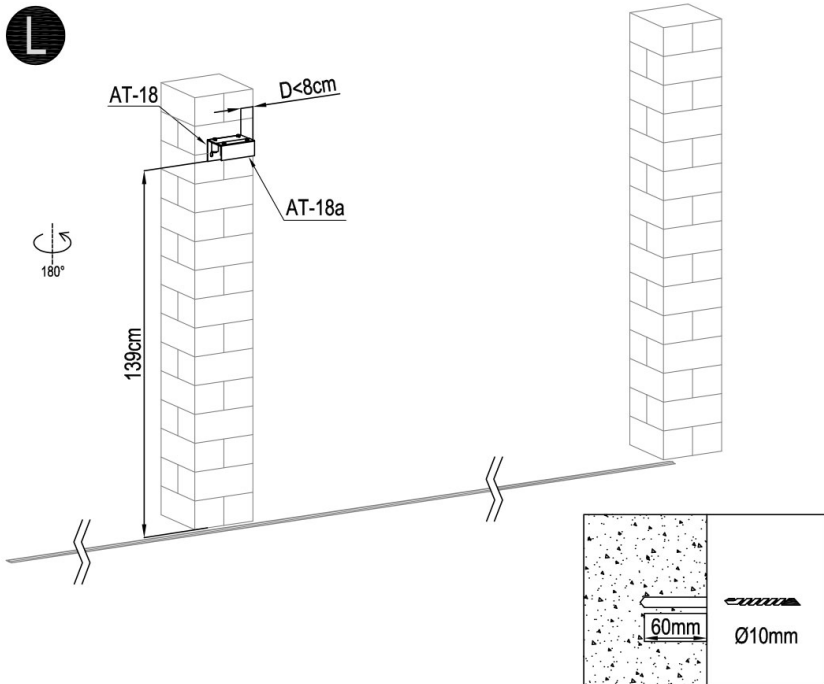

	AT-18	1
	AT-18a	1
	AT-20	4
	RA-CA31	3

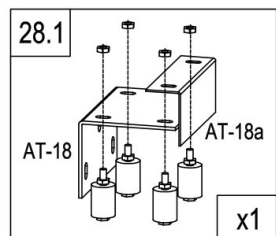
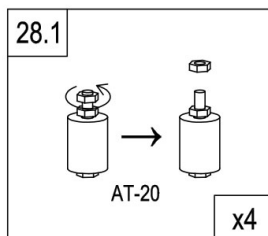

L

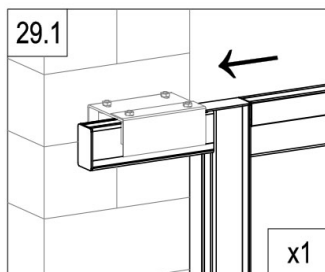
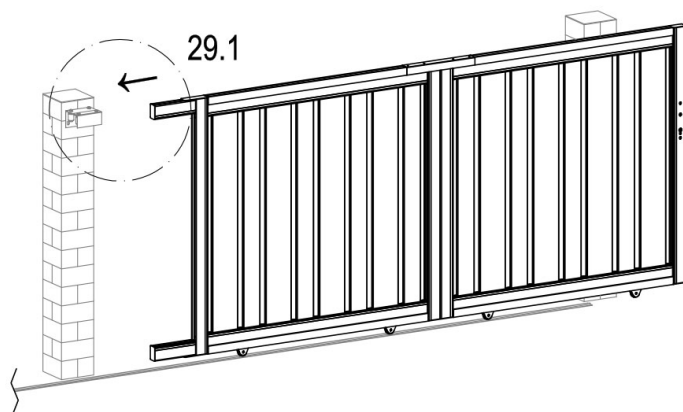

L

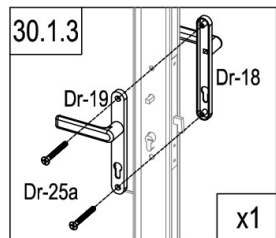
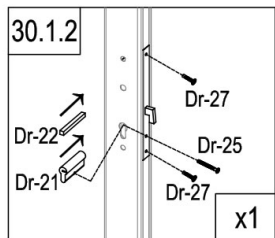
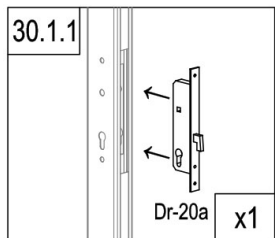
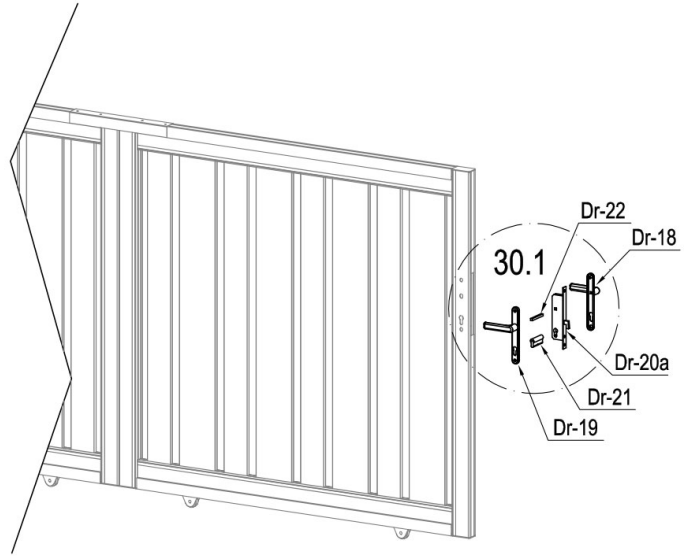

	Dr-20a	1
	Dr-21	1
	Dr-22	1
	Dr-25	1

	Dr-18	1
	Dr-19	1
	Dr-25a	2
	Dr-27	2

L

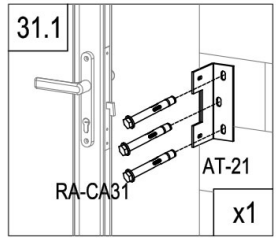
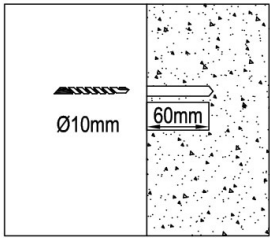
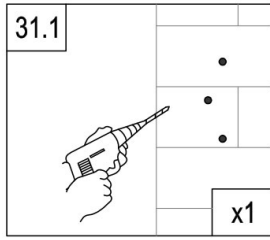
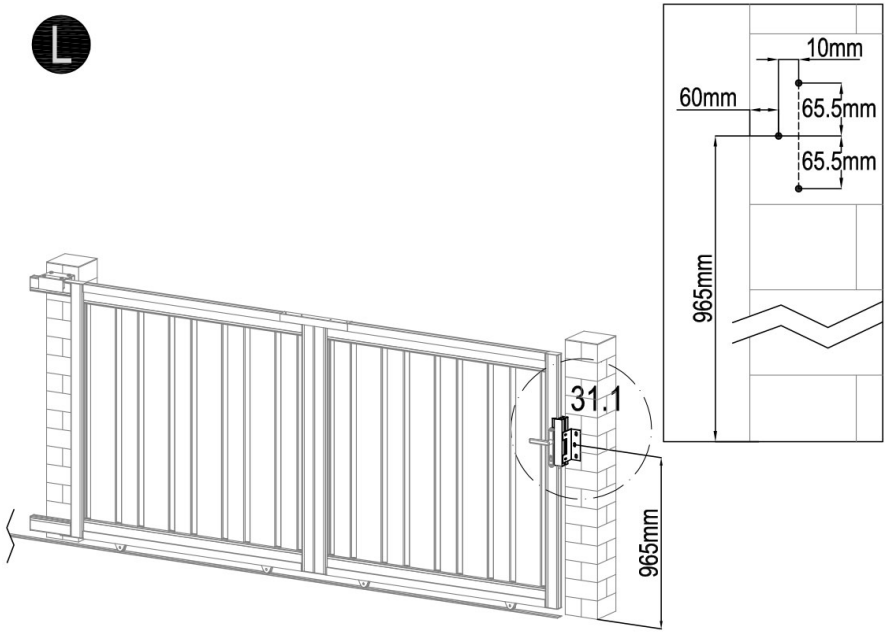

	AT-16	1
	AT-21	1
	RA-CA36	2
	RA-CA31	3
	AT-22J	3

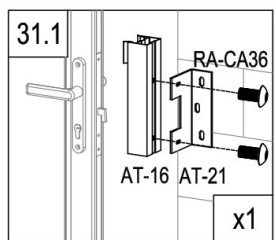
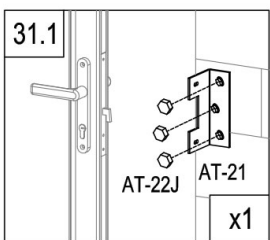

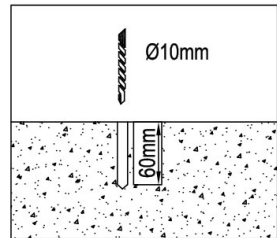
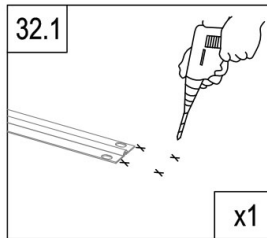
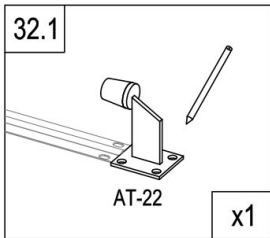
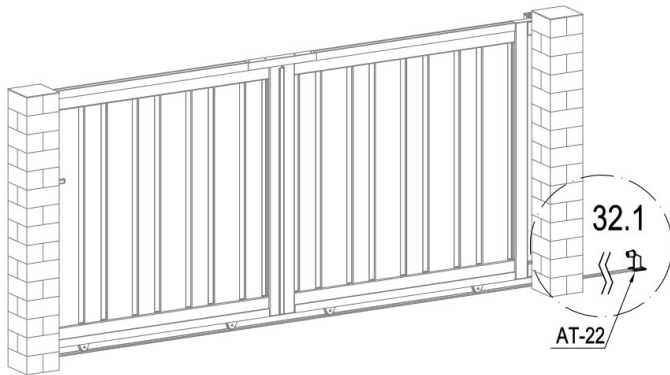

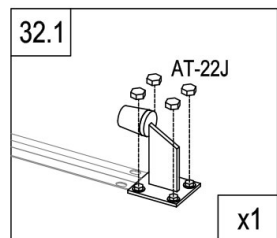
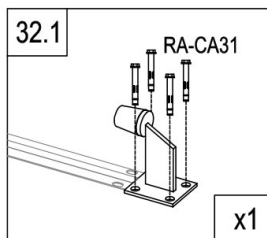

	AT-22	1
	RA-CA31	4
	AT-22J	4

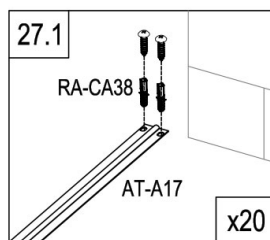
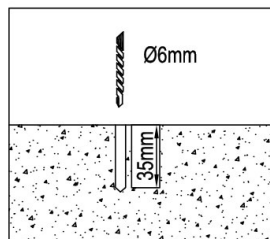
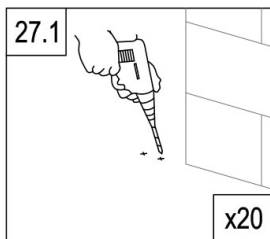
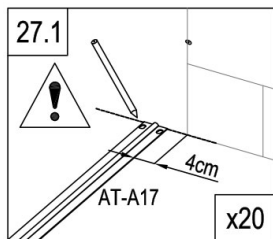
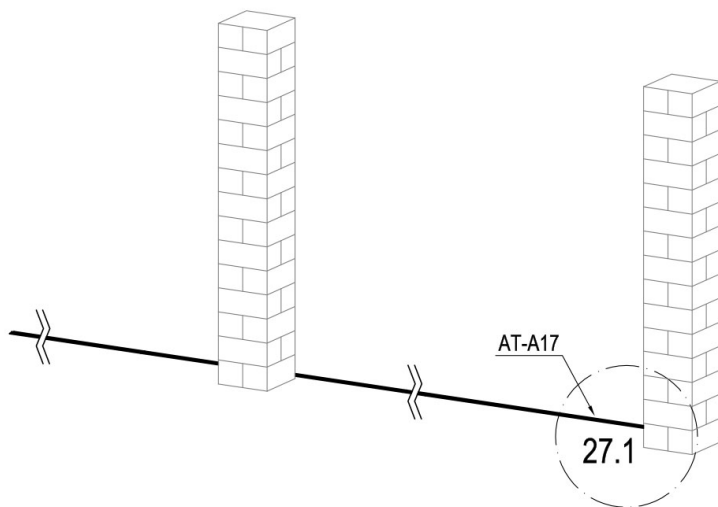

R



	AT-A17	5
	RA-CA38	40



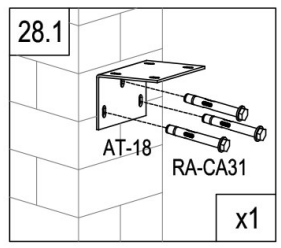
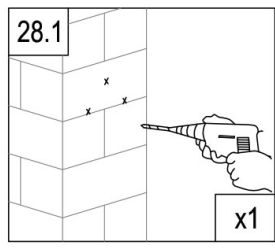
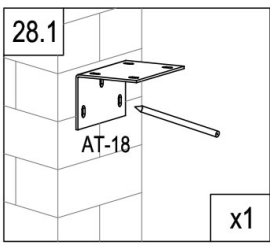
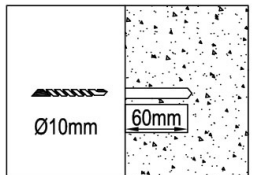
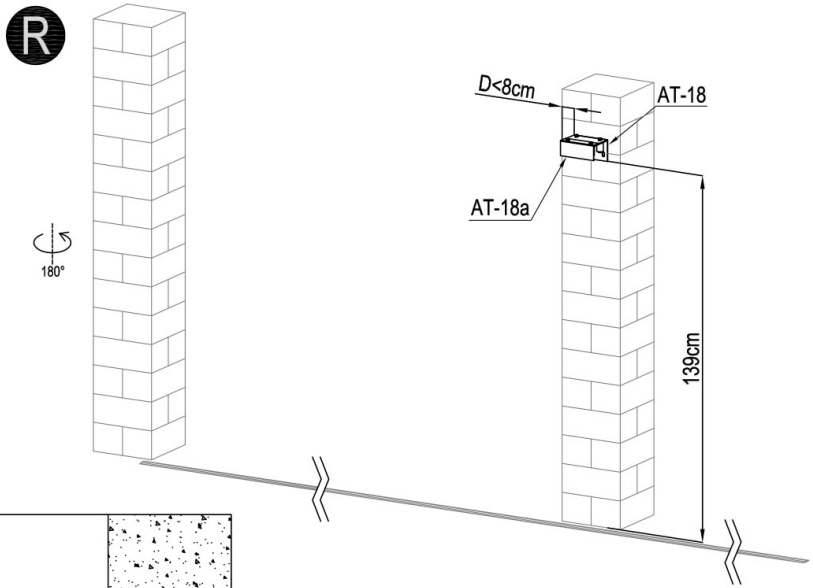

	AT-18	1
	AT-18a	1
	AT-20	4
	RA-CA31	3

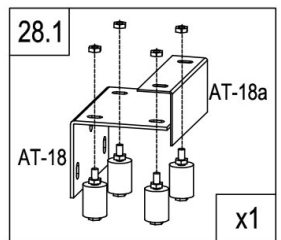
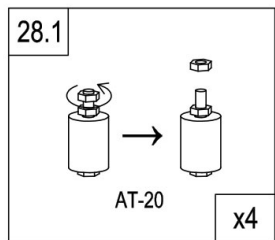

R

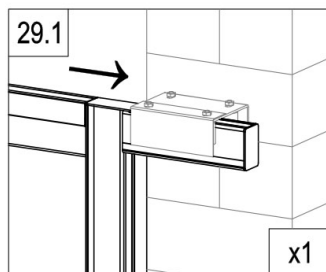
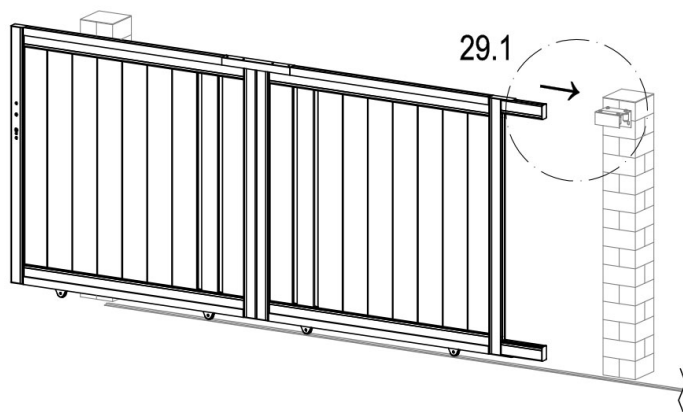

**R**

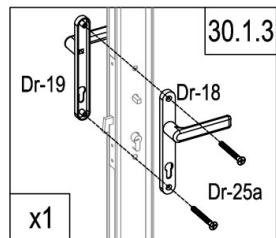
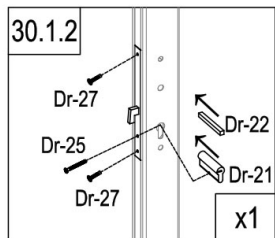
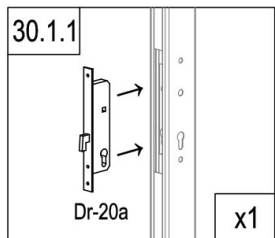
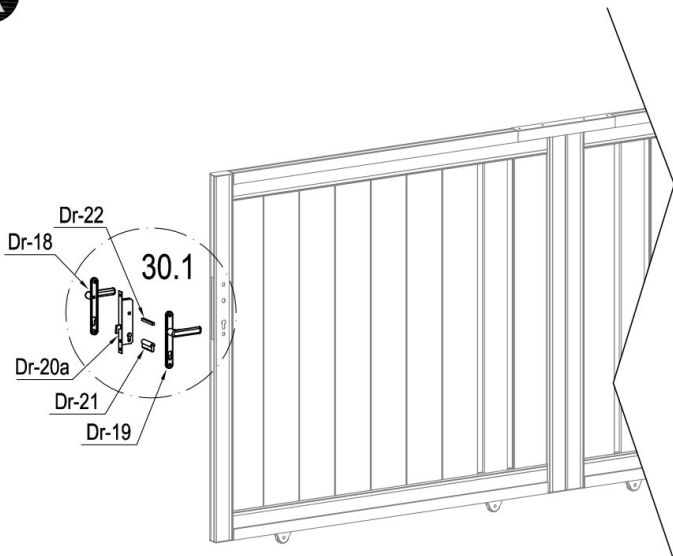

	Dr-20a	1
	Dr-21	1
	Dr-22	1
	Dr-25	1

	Dr-18	1
	Dr-19	1
	Dr-25a	2
	Dr-27	2

R

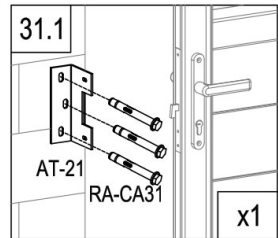
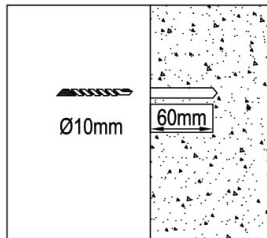
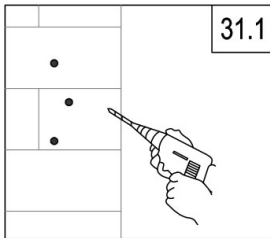
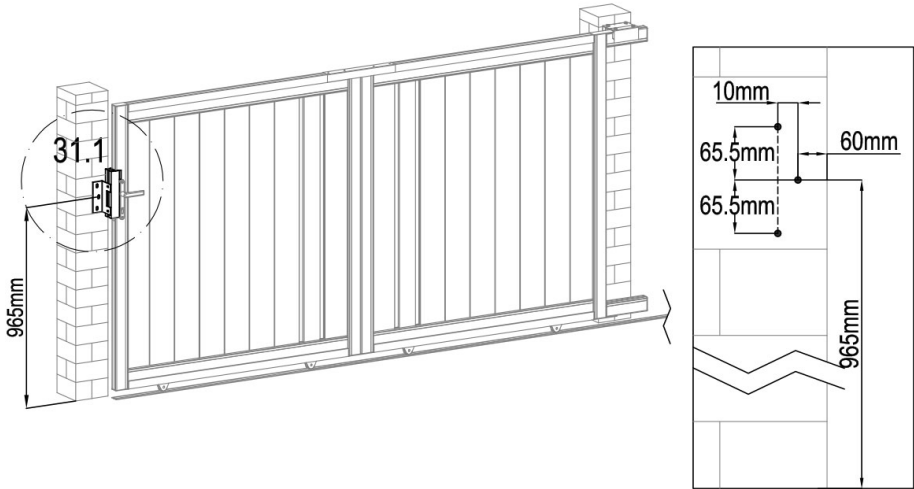

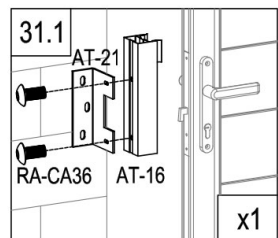
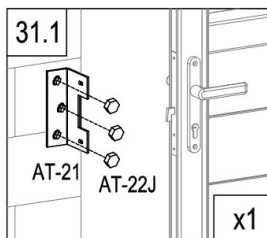

	AT-16	1
	AT-21	1
	RA-CA36	2
	RA-CA31	3
	AT-22J	3

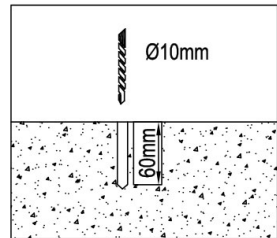
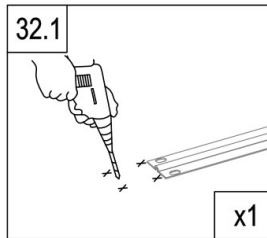
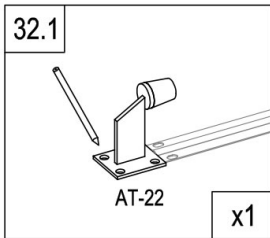
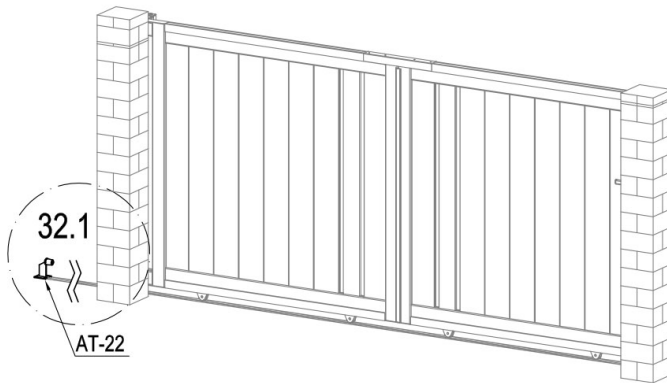

R



	AT-22	1
	RA-CA31	4
	AT-22J	4

