

# CASANOVO

## GIONA 300C160

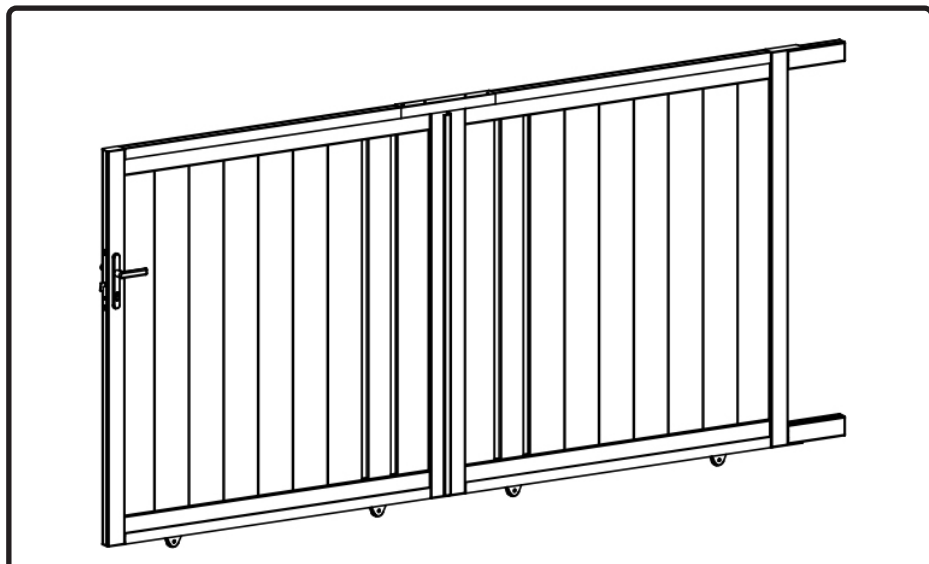

COM-000807 [x1]

COM-000809 [x1]

COM-000808 [x1]



7-8H



X 2

EN FR DE ES PT IT NL PL FI SE DK  
RO SI SK HU CZ HR GR LT LV



INSTRUCTION MANUAL / NOTICE DE MONTAGE / MONTAGEANLEITUNG / MANUAL DE MONTAJE / MANUAL DE MONTAGEM / MANUALE DI MONTAGGIO /  
MONTAGEHANDLEIDING / INSTRUKCJA MONTAŻU / KÄYTTÖOHJEET / BRUKSANVISNING / BRUGSANVISNING / INSTRUCȚIUNI DE ASAMBLARE /  
NAVODILA ZA SESTAVLJANJE / NÁVOD NA MONTÁŽ / ÖSSZESZERELÉSI ÚTMUTATÓ / NÁVOD K MONTÁŽI / UPUTE ZA INSTALACIJU /  
ΟΔΗΓΙΕΣ ΣΥΝΑΡΜΟΛΟΓΗΣΗΣ / SURINKIMO INSTRUKCIJOS / MONTŽAS INSTRUKCIJAS

**Ext.**

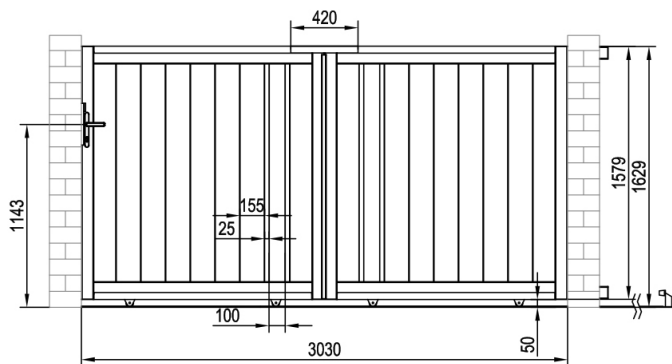

**Int.**

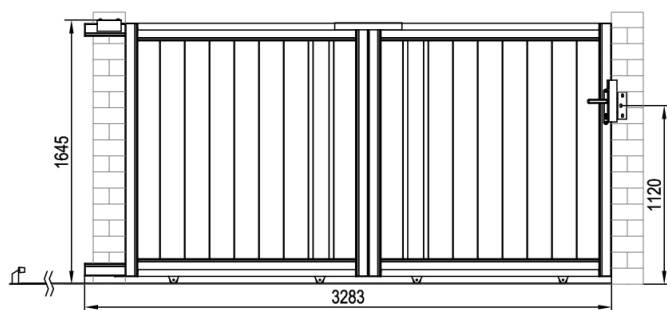

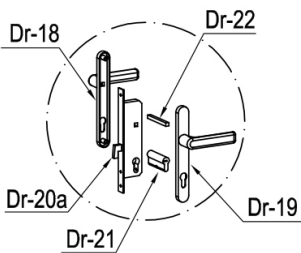
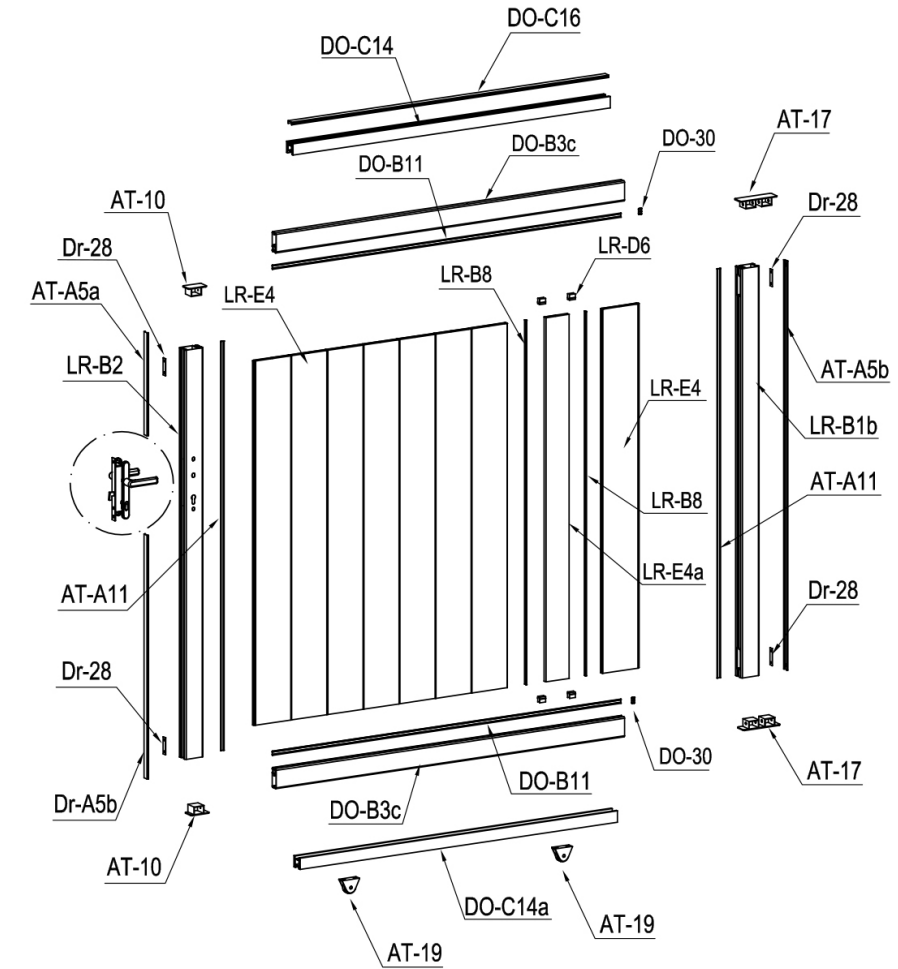

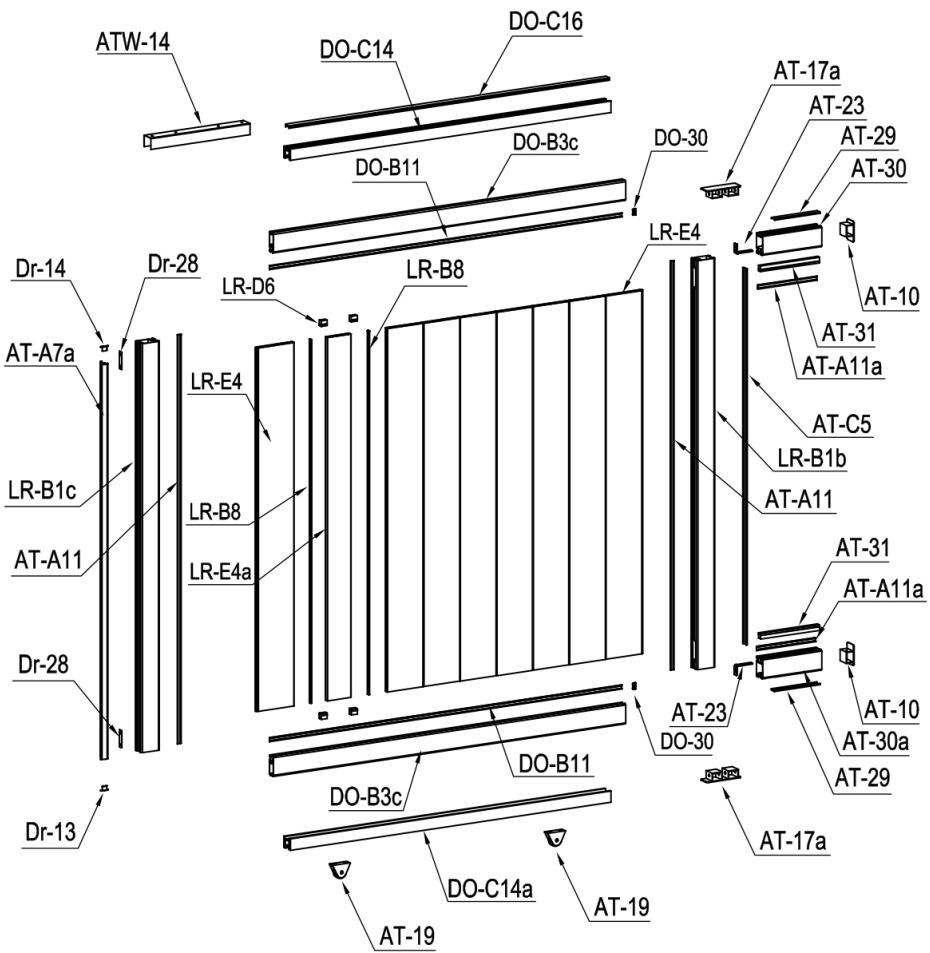

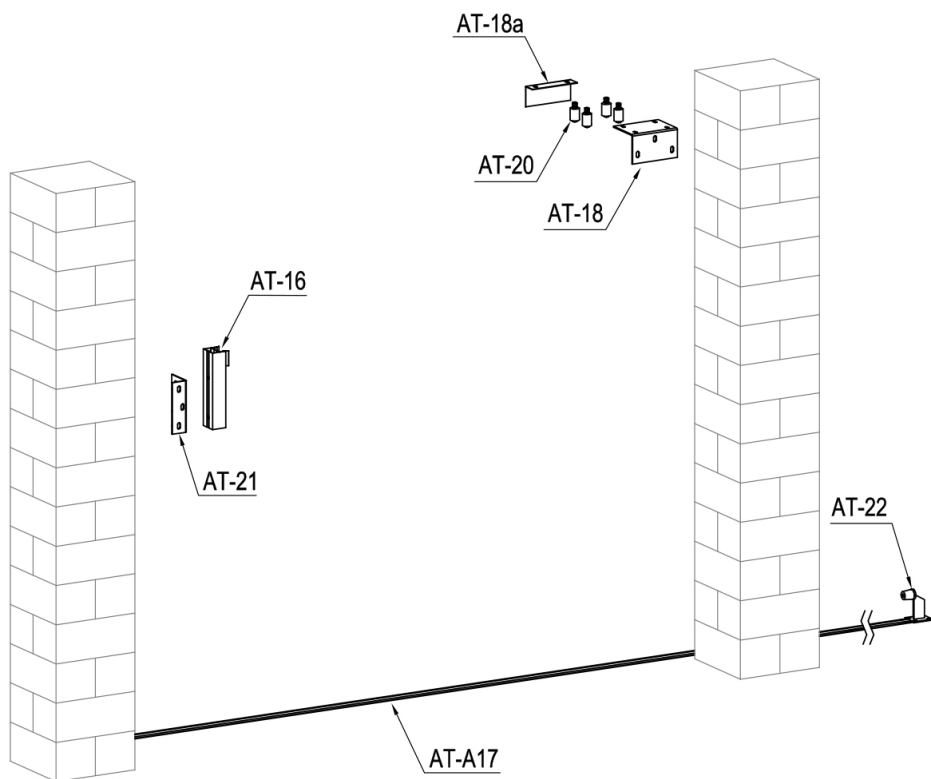

















































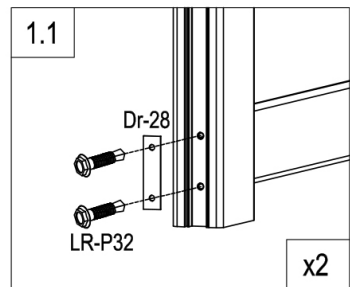
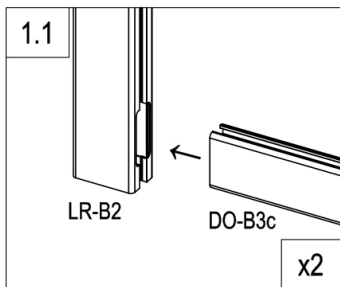
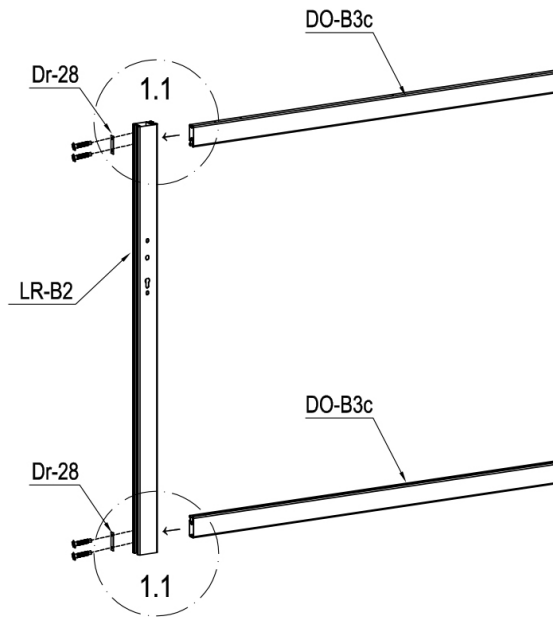

# CASANOVA



IMAGE	NO.	L.(mm)	QTY	IMAGE	NO.	L.(mm)	QTY
	LR-B1b	1573	2		DO-30		4
	LR-B1c	1573	1		AT-18		1
	LR-B2	1573	1		AT-18a		1
	AT-30	250	1		ATW-14		1
	AT-30a	250	1		AT-19		4
	DO-B3c	1492	4		AT-20		4
	LR-E4	1400	16		AT-21		1
	LR-E4a	1400	2		AT-22		1
	AT-A5b	1573	1		AT-23		2
	AT-C5	1448	1		Dr-18		1
	AT-A5a	395.5	1		Dr-19		1
	Dr-A5b	937	1		Dr-20a		1
	AT-29	193	2		Dr-21		1
	AT-A11	1573	4		Dr-22		1
	AT-A11a	250	2		Dr-25		1
	DO-B11	1492	4		Dr-25a		2
	AT-31	250	2		Dr-27		2
	LR-D6	25	8		Dr-28		6
	LR-B8	1400	4		AT-22J		7
	AT-A7a	1520	1		LR-P30		4
	DO-C14	1358	2		LR-P31		10
	DO-C14a	1358	2		LR-P32		28
	DO-C16	1357	2		LR-P33		4
	AT-16		1		LR-P34		12
	AT-A17	1212	5		LR-P35		42
	AT-17		2		LR-P36		2
	AT-17a		2		LR-P37		8
	AT-10		4		LR-P38		40
	Dr-13		1				
	Dr-14		1				

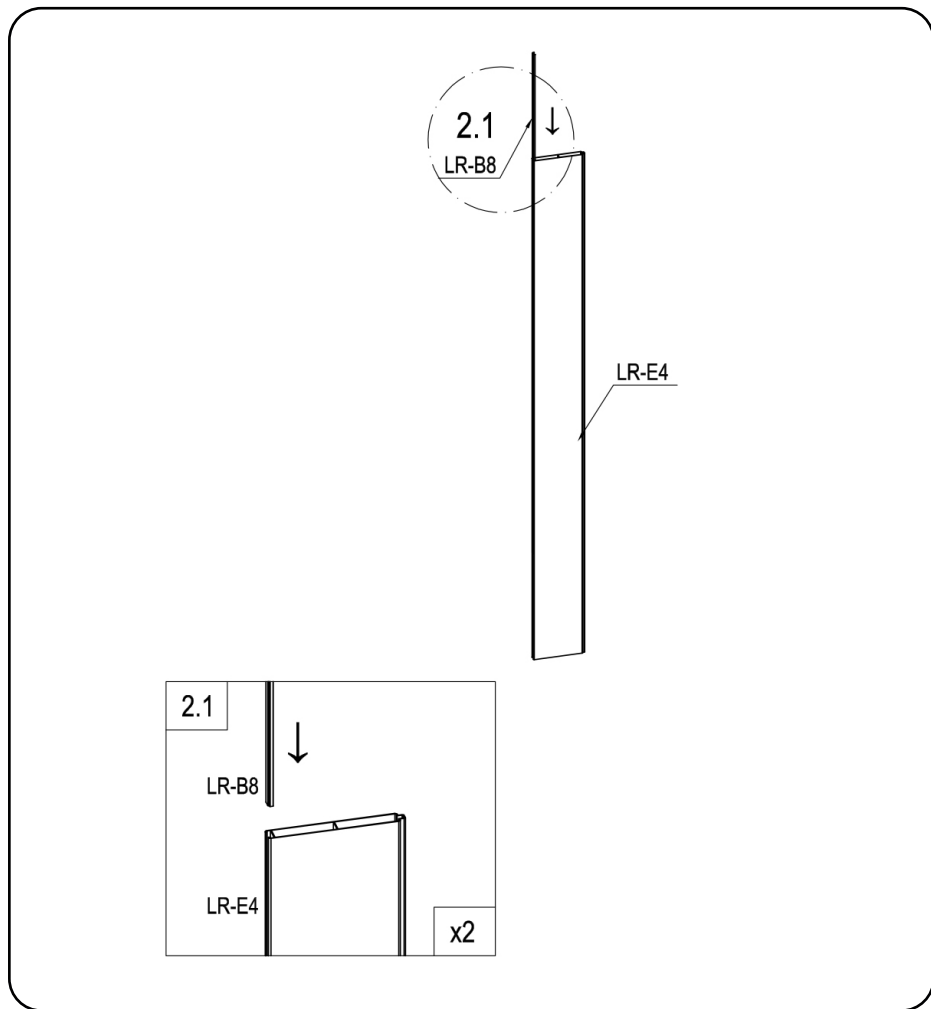

	LR-B2	1
	DO-B3c	2
	Dr-28	2
	LR-P32	4



X2



	LR-B8	2
	LR-E4	2

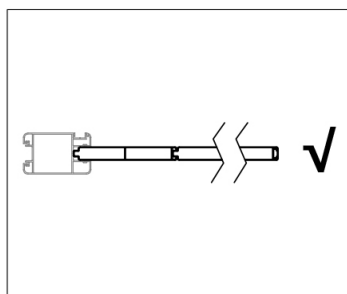
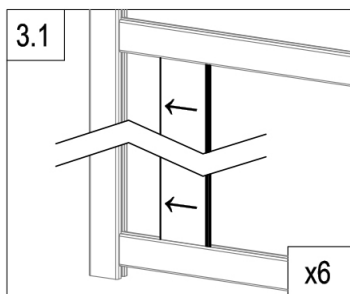
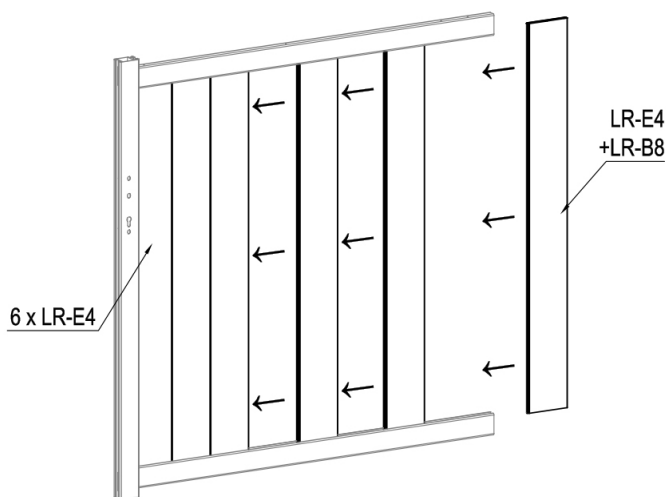



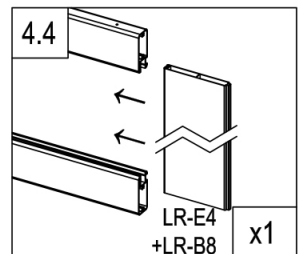
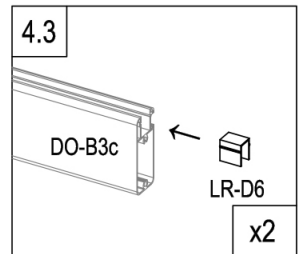
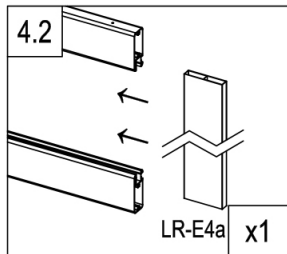
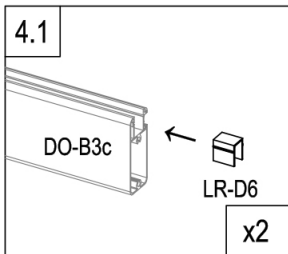
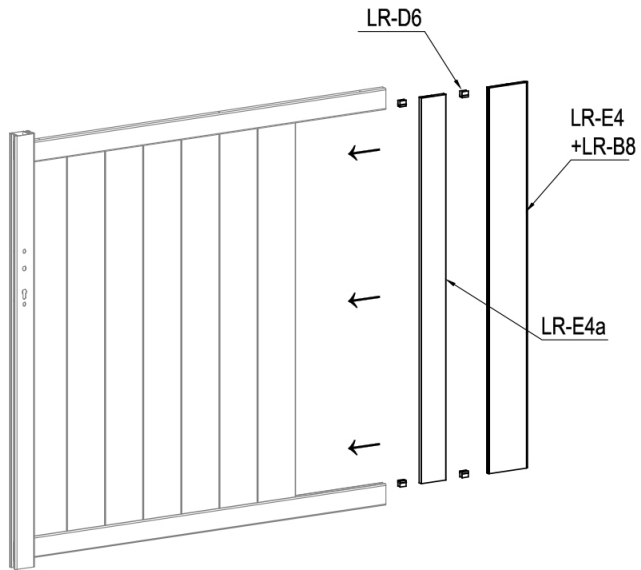



	LR-E4	6
---	-------	---

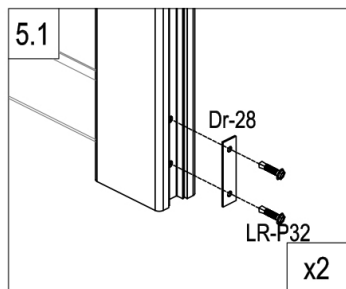
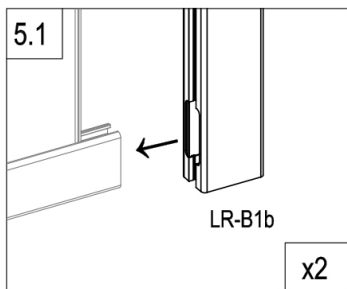
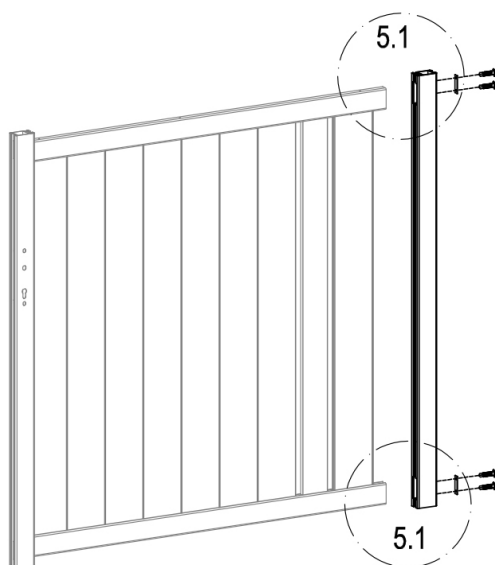



	LR-E4a	1
	LR-D6	4

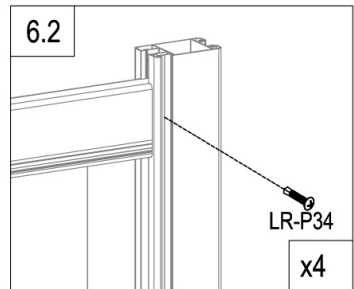
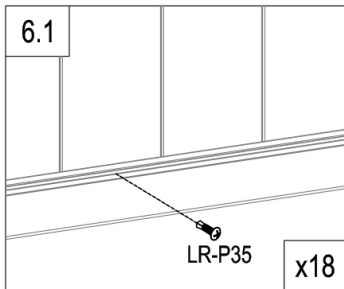
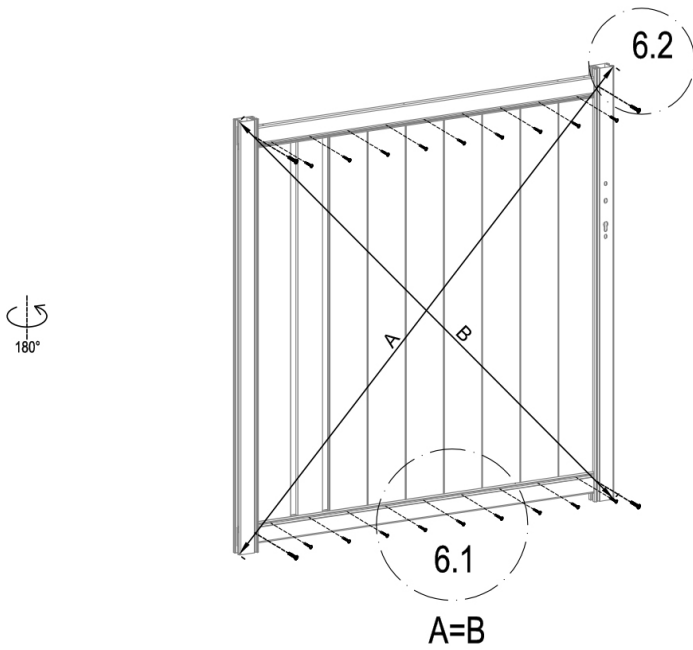

	LR-B1b	1
	Dr-28	2
	LR-P32	4



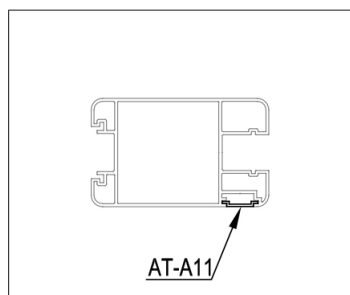
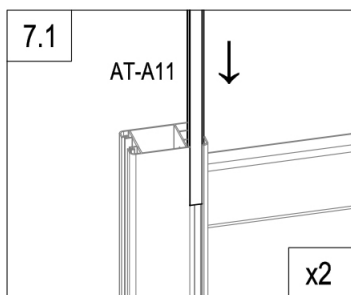
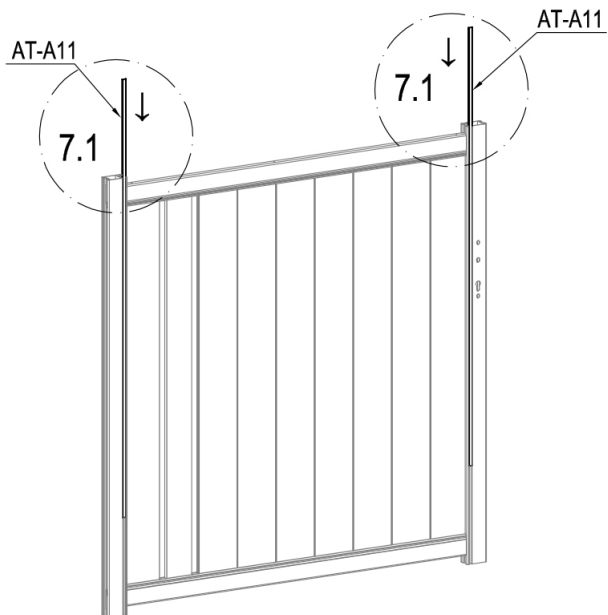

	LR-P35	18
	LR-P34	4

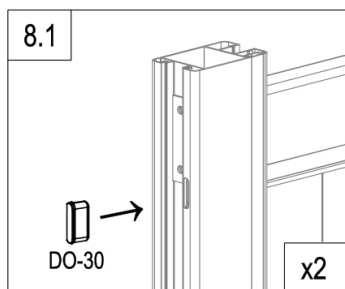
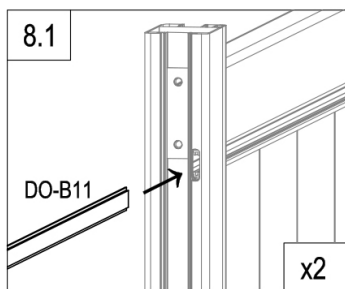
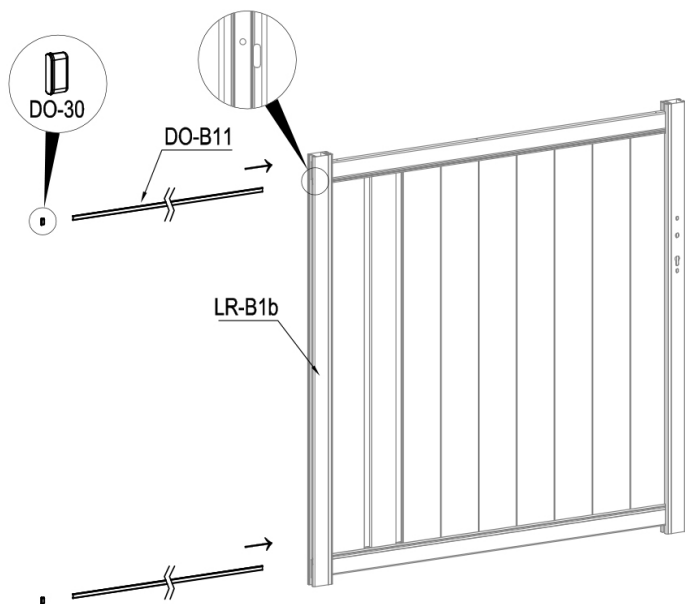

	AT-A11	2
---	--------	---



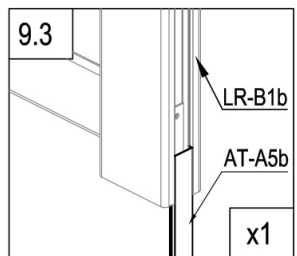
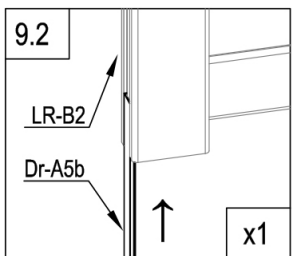
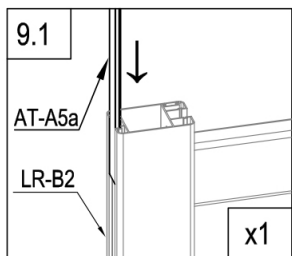
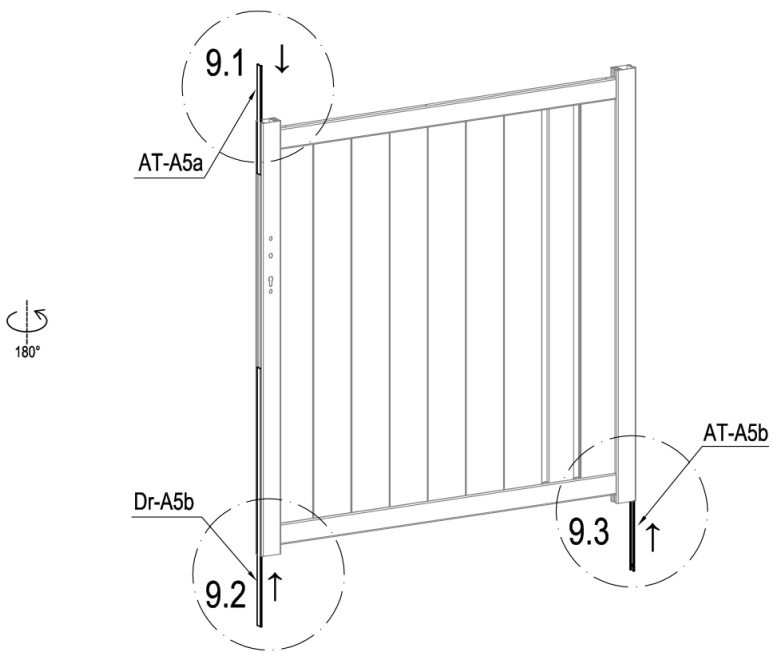

	DO-B11	2
	DO-30	2

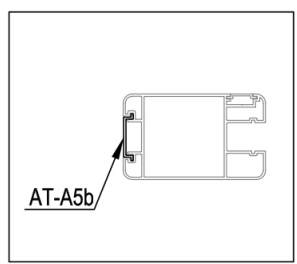

	AT-A5b	1
	AT-A5a	1
	Dr-A5b	1

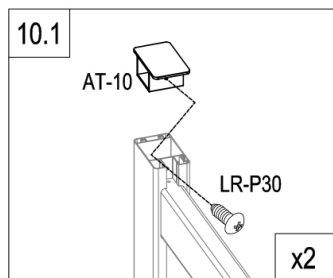
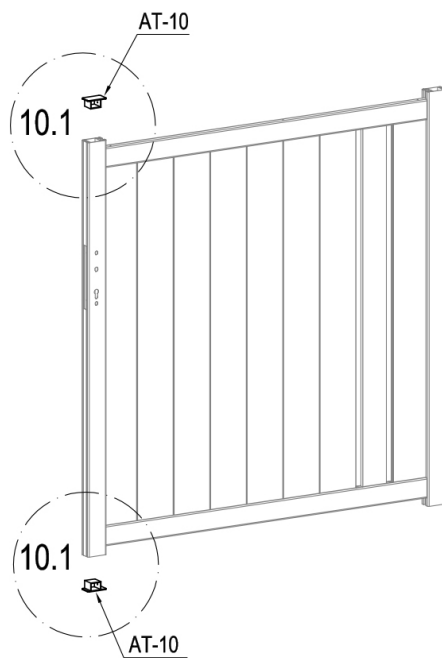





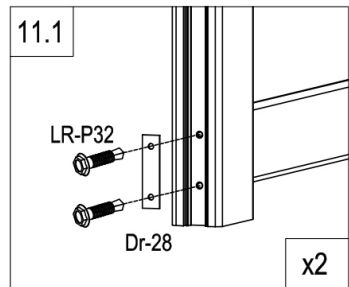
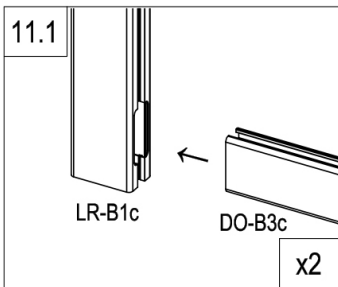
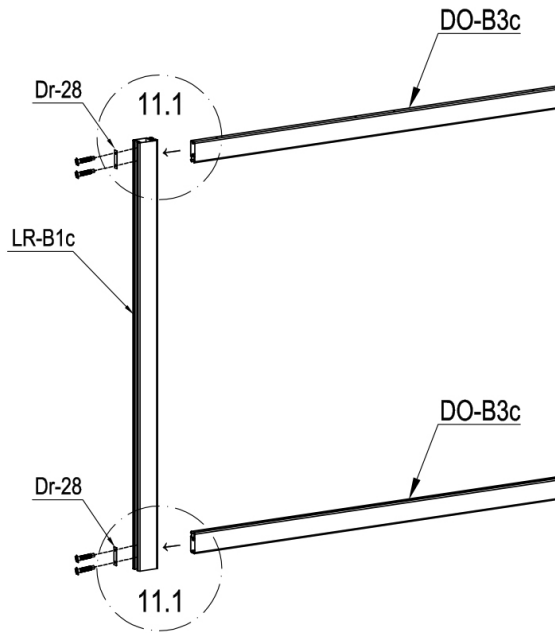

	AT-10	2
	LR-P30	2







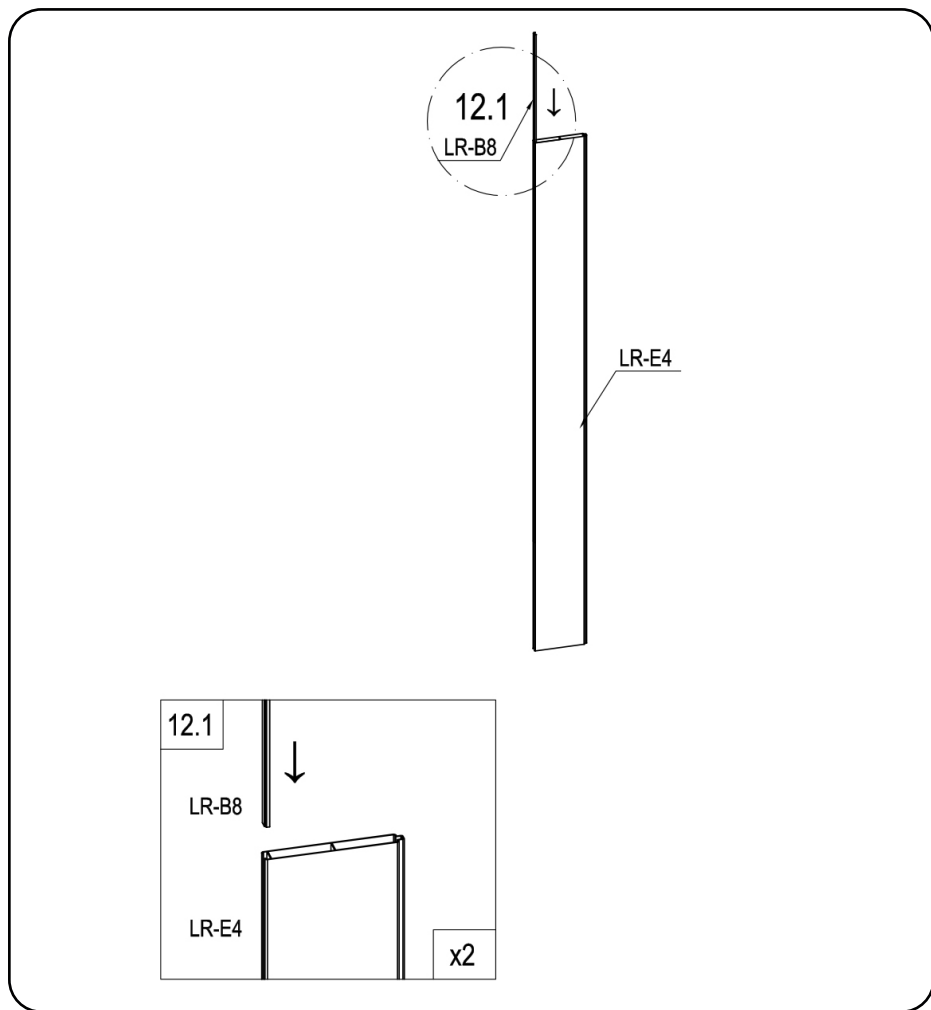

	LR-B1c	1
	DO-B3c	2
	Dr-28	2
	LR-P32	4



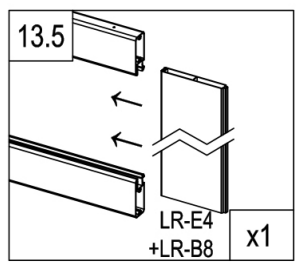
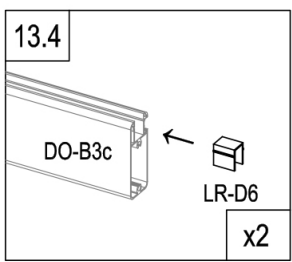
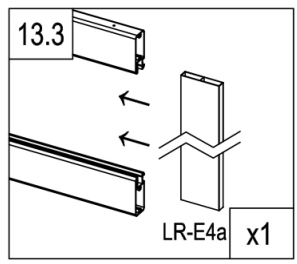
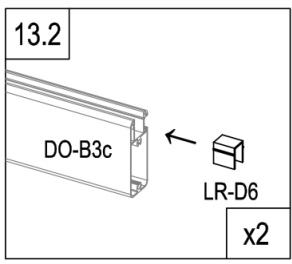
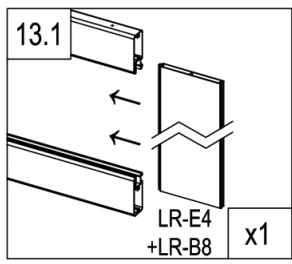
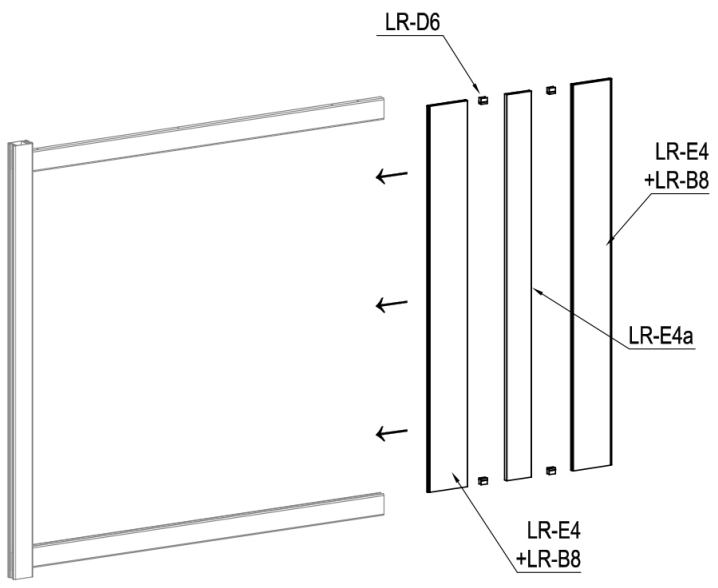

**X2**

	LR-B8	2
	LR-E4	2



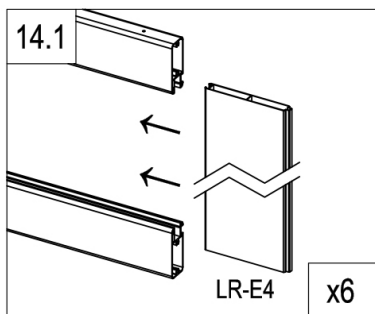
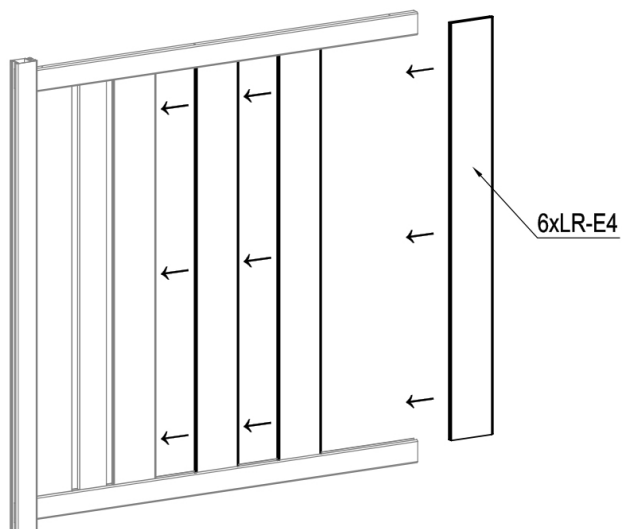

	LR-E4a	1
	LR-D6	4



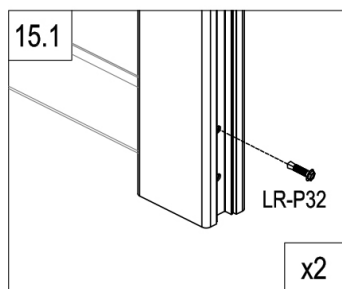
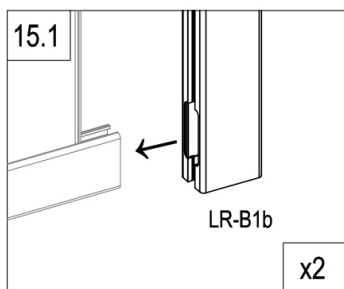
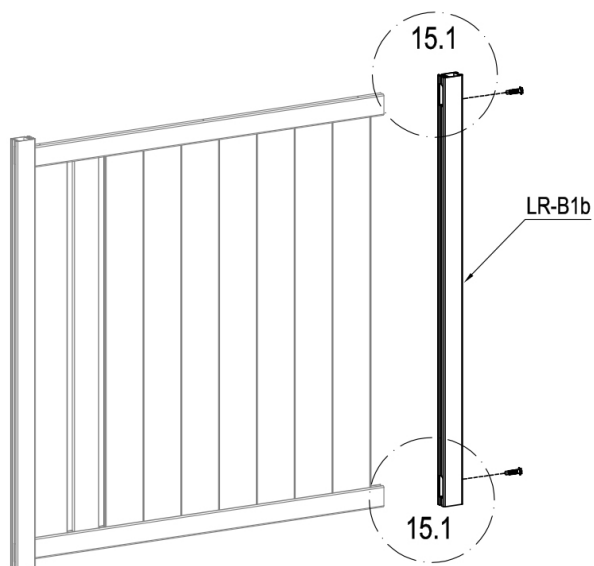

	LR-E4	6
---	-------	---

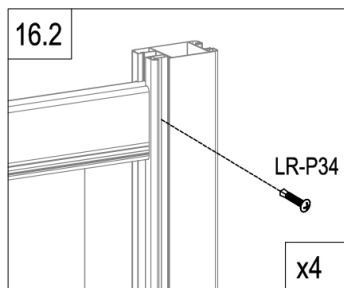
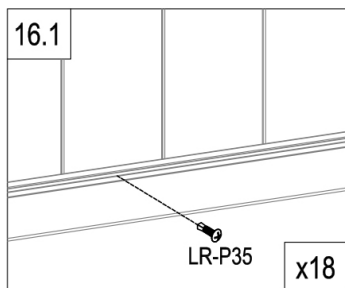
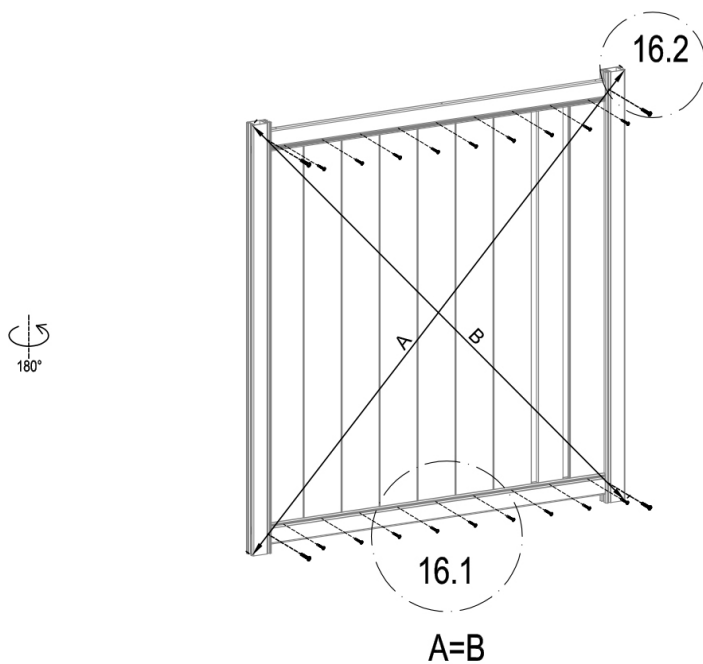

	LR-B1b	1
	LR-P32	2



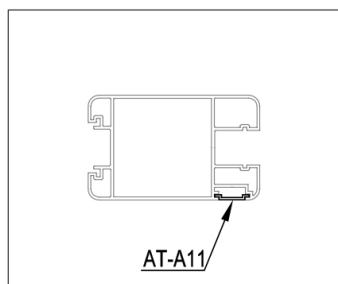
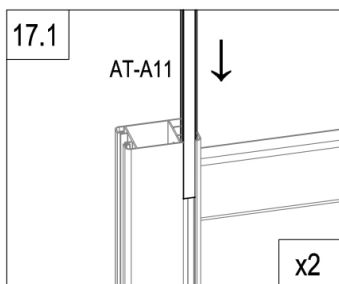
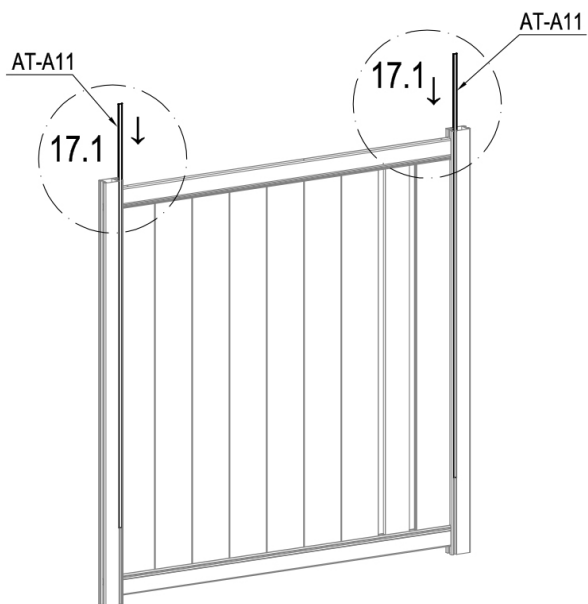

	LR-P35	18
	LR-P34	4



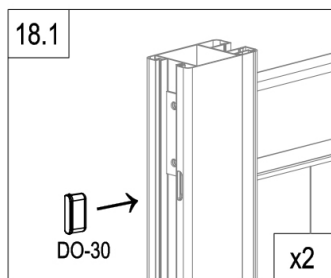
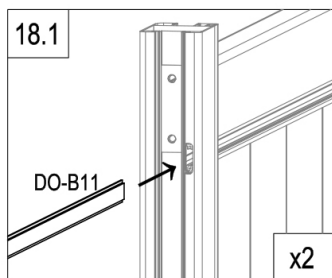
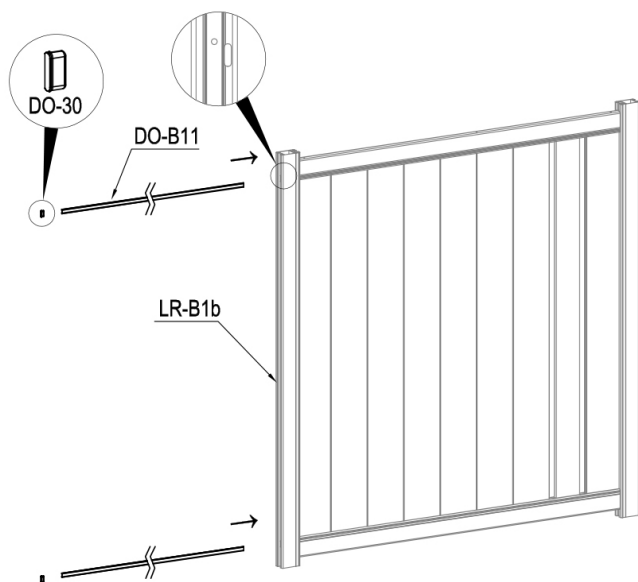



	AT-A11	2
---	--------	---



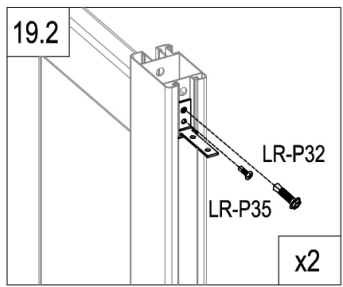
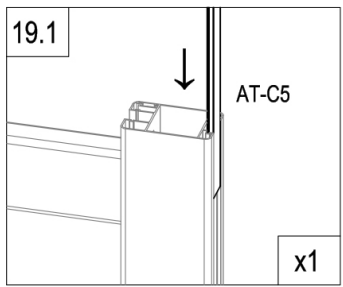
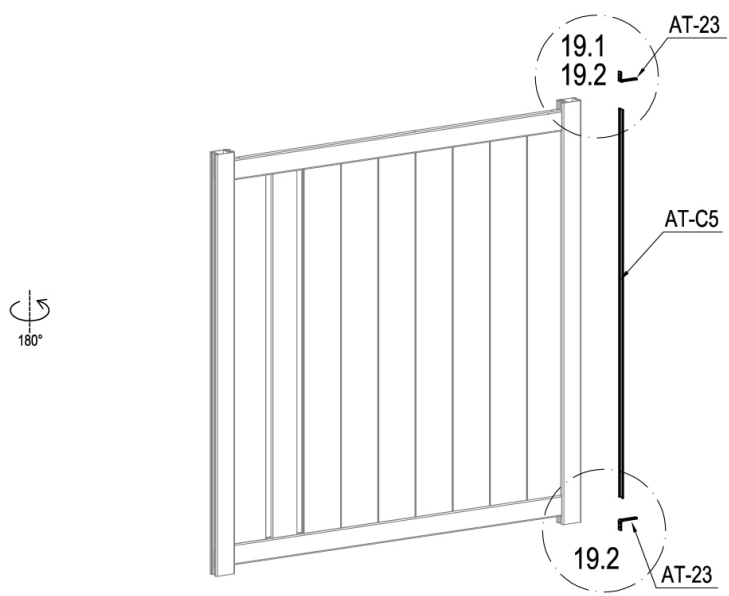

	DO-B11	2
	DO-30	2





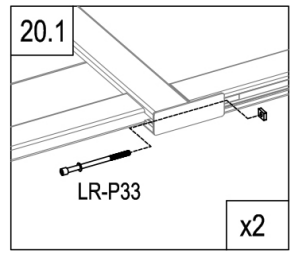
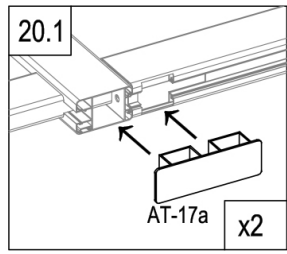
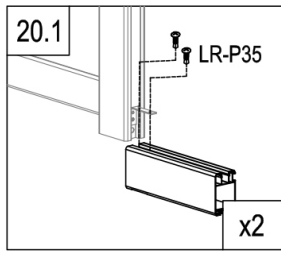
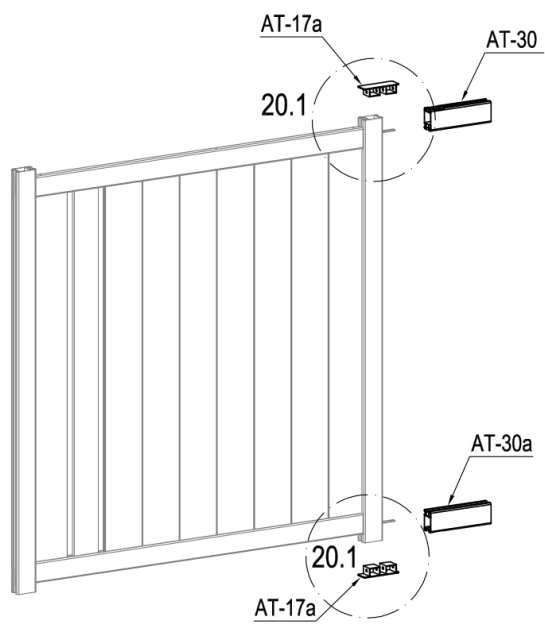





	AT-C5	1
	AT-23	2
	LR-P32	2
	LR-P35	2



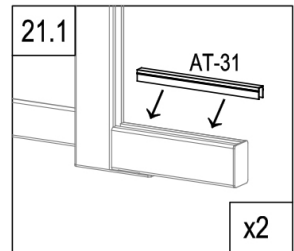
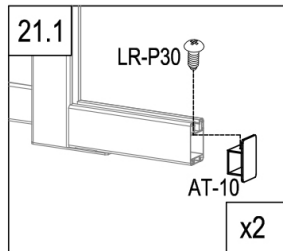
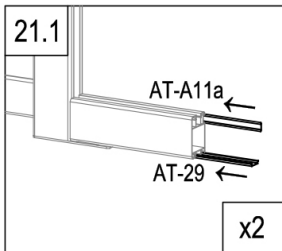
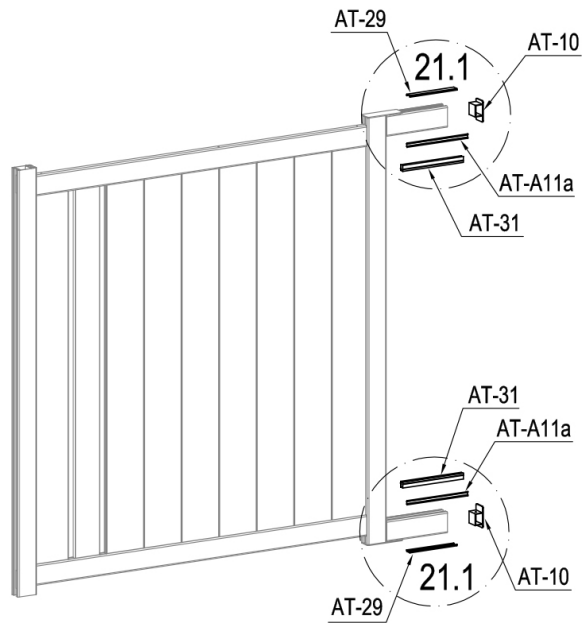

	AT-30	1
	AT-30a	1
	AT-17a	2



	LR-P33	2
	LR-P35	4

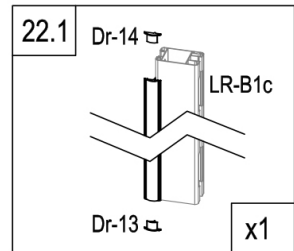
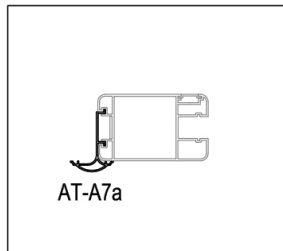
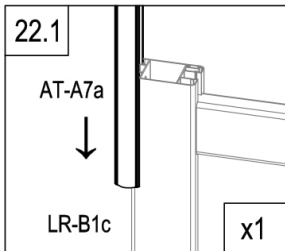
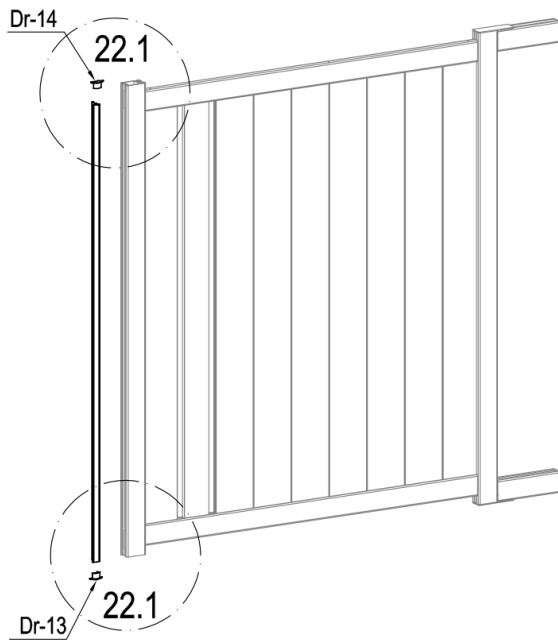

	AT-29	2
	AT-A11a	2
	AT-31	2

	AT-10	2
	LR-P30	2



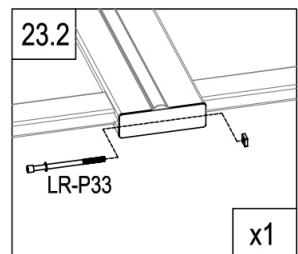
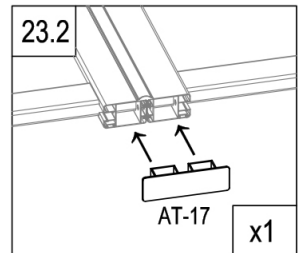
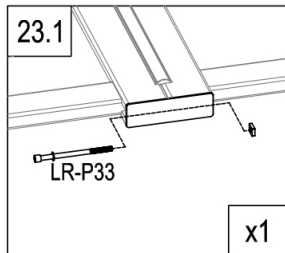
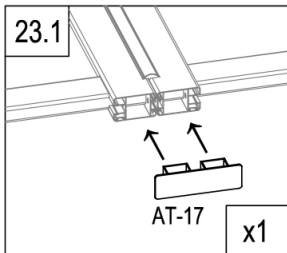
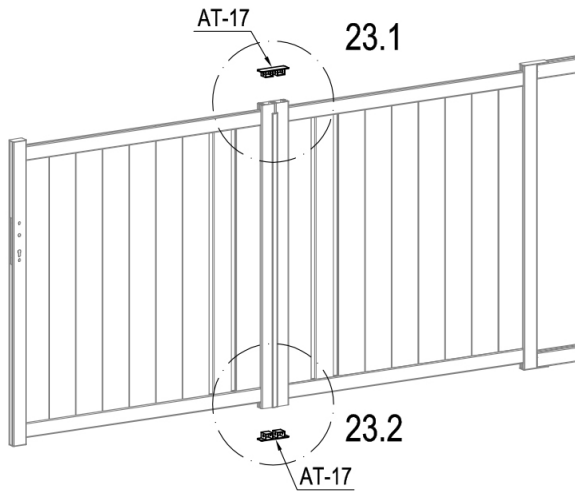

	AT-A7a	1
	Dr-13	1
	Dr-14	1



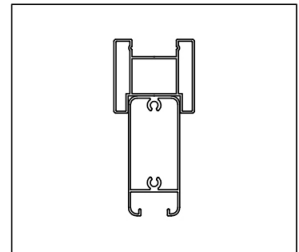
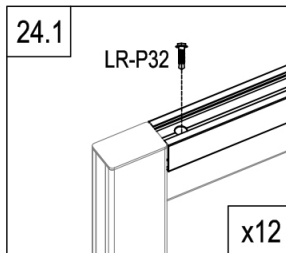
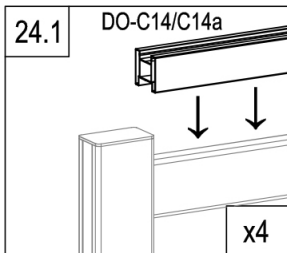
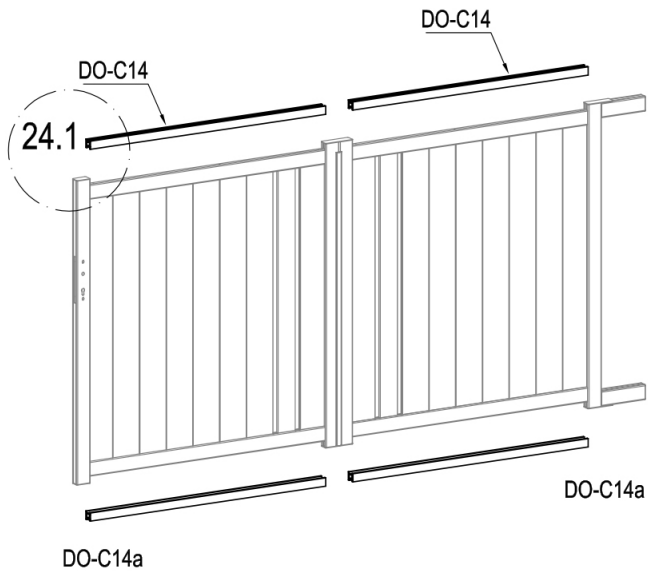

	AT-17	2
	LR-P33	2



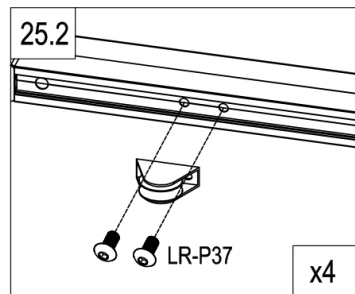
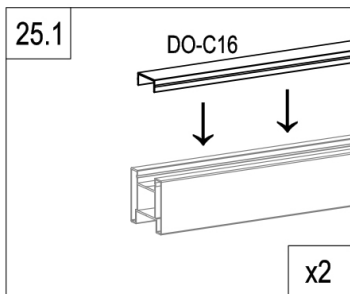
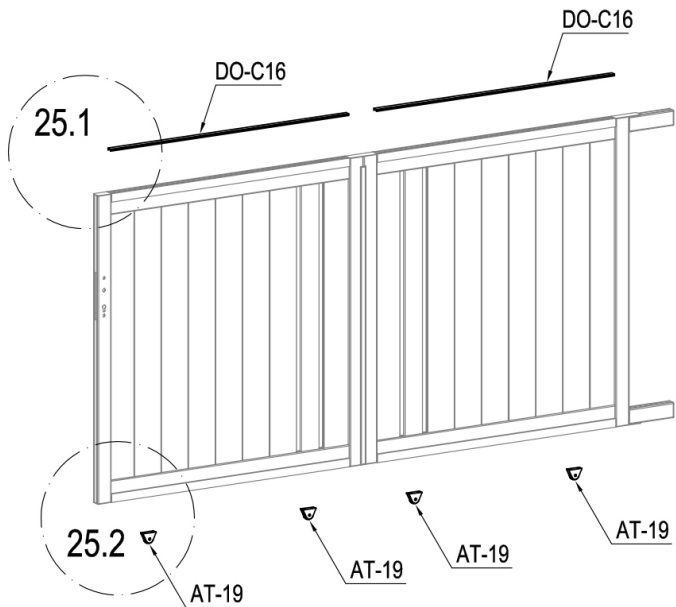

	DO-C14	2
	DO-C14a	2
	LR-P32	12

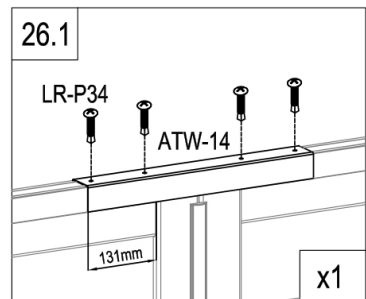
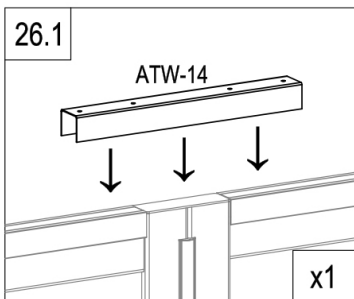
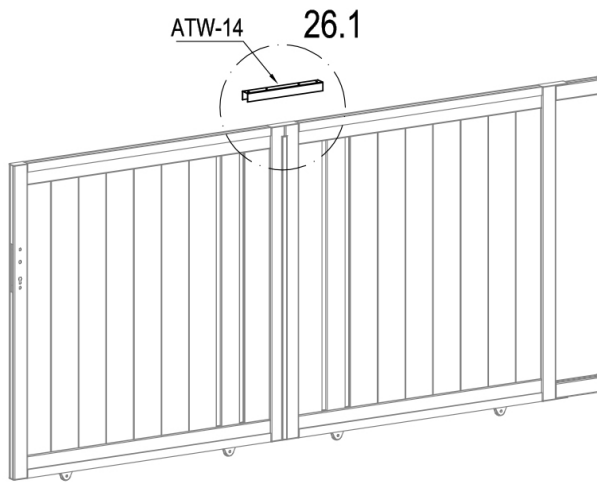

	DO-C16	2
	AT-19	4
	LR-P37	8



	ATW-14	1
	LR-P34	4



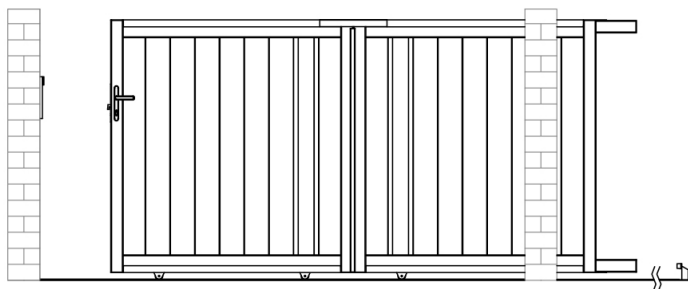

**L** : P27~32

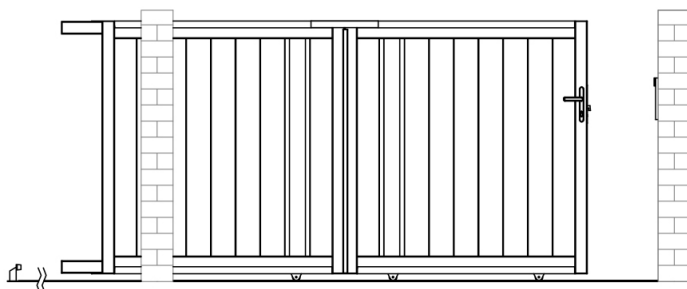

**R** : P33~38

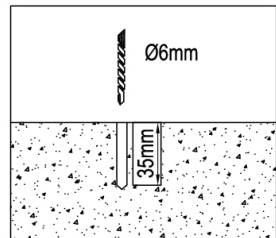
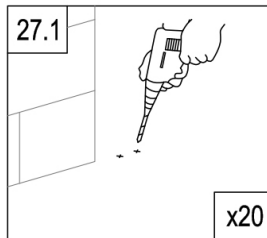
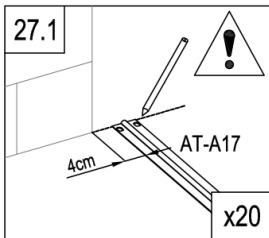
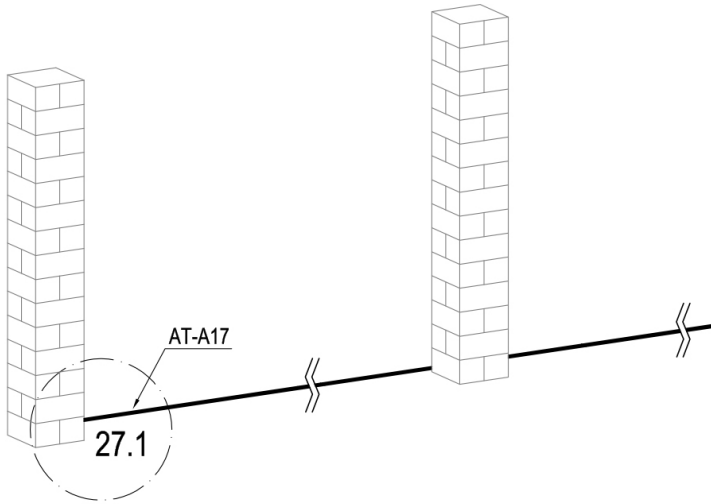

	AT-A17	5
	LR-P38	40

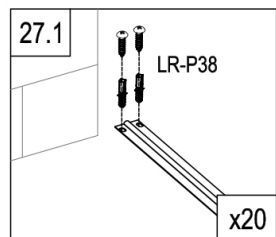

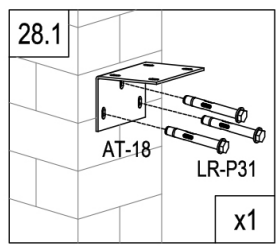
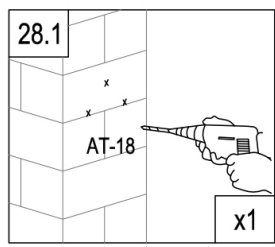
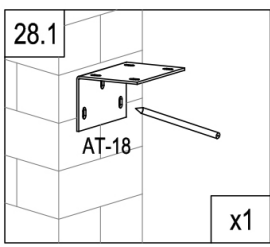
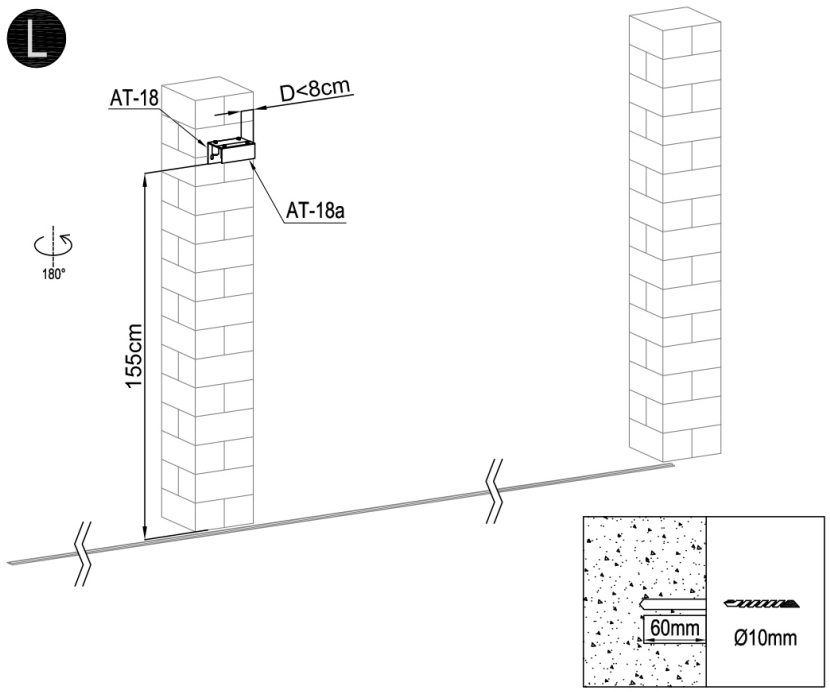

	AT-18	1
	AT-18a	1
	AT-20	4
	LR-P31	3

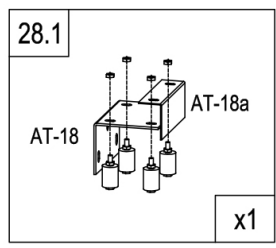
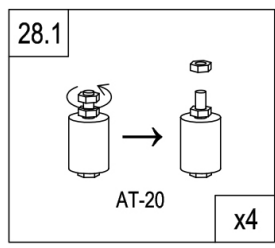

L

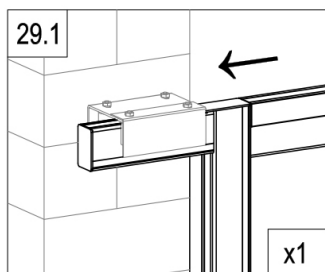
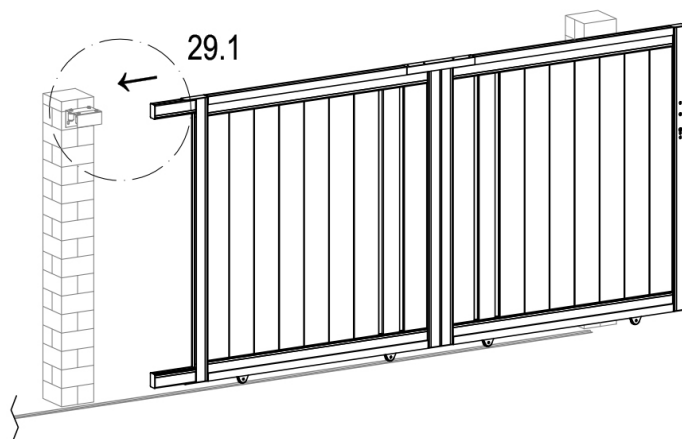

L

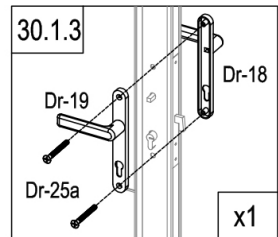
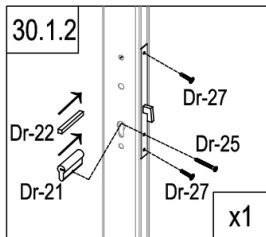
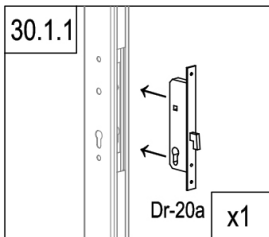
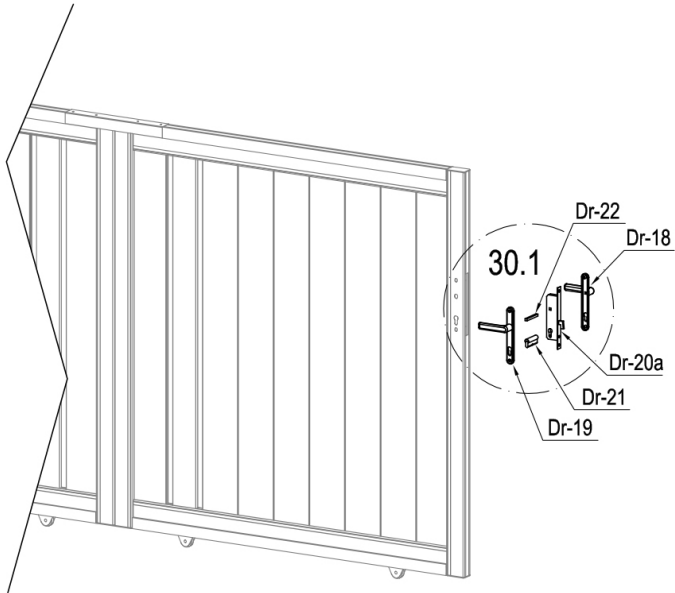

	Dr-20a	1
	Dr-21	1
	Dr-22	1
	Dr-25	1

	Dr-18	1
	Dr-19	1
	Dr-25a	2
	Dr-27	2

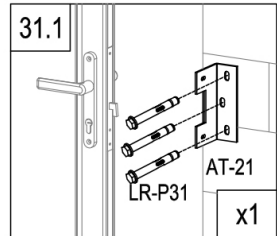
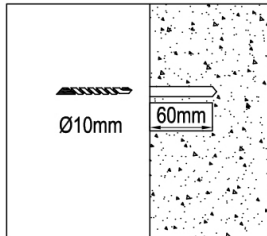
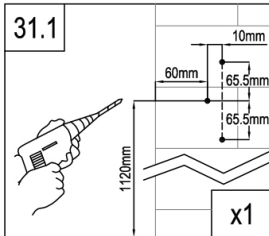
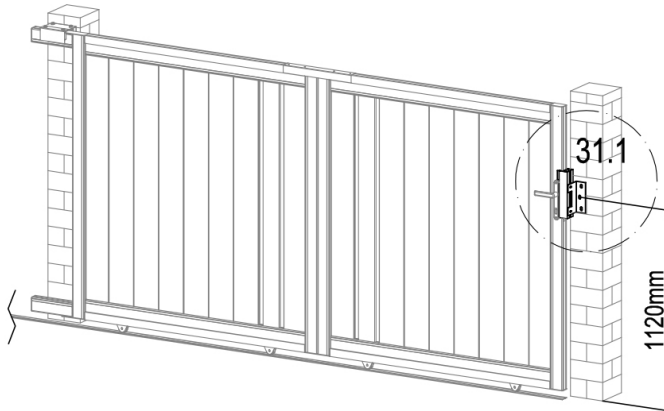

	AT-16	1
	AT-21	1
	LR-P36	2
	LR-P31	3
	AT-22J	3

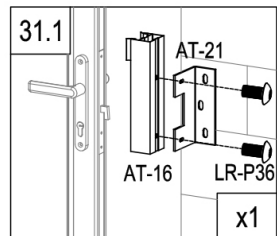
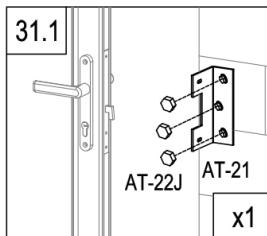

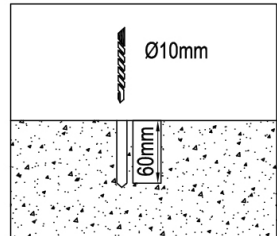
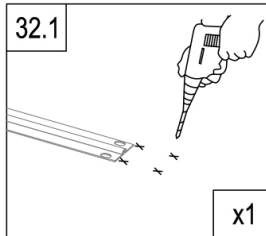
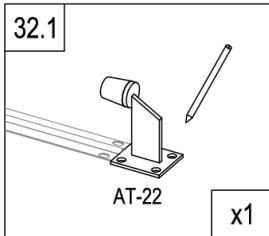
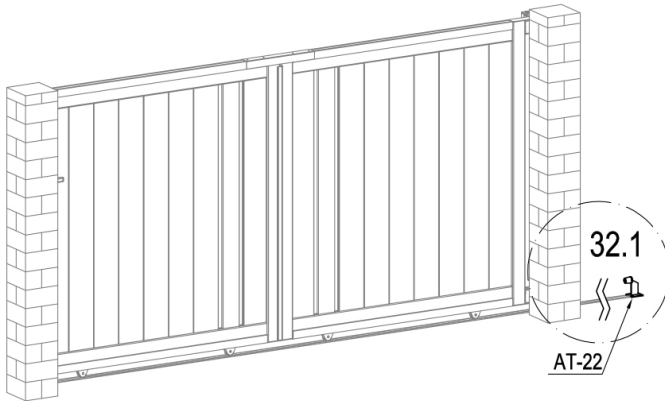

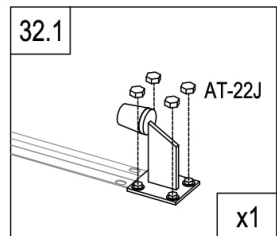
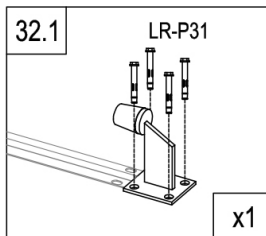

	AT-22	1
	LR-P31	4
	AT-22J	4

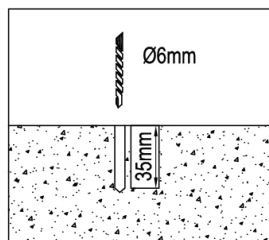
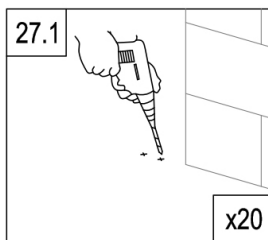
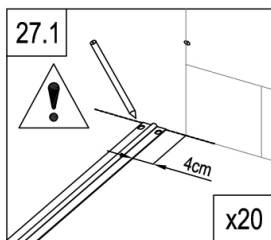
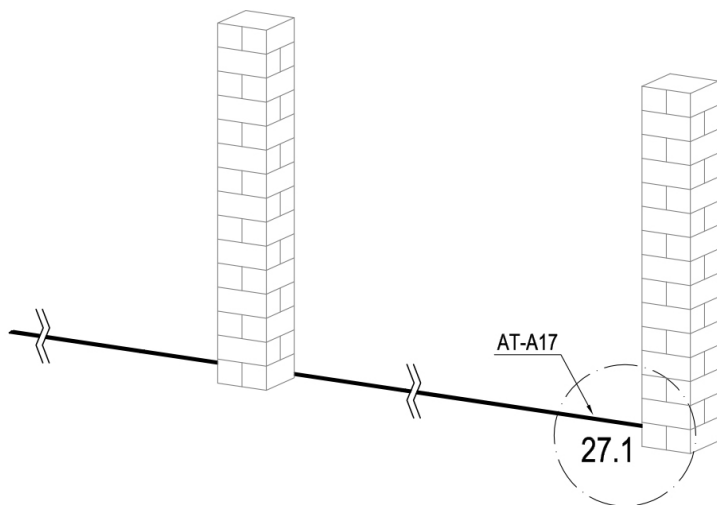

R



	AT-A17	5
	LR-P38	40

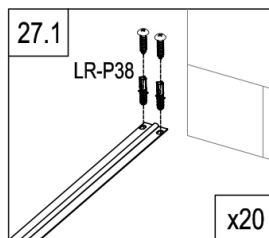



**R**

180°

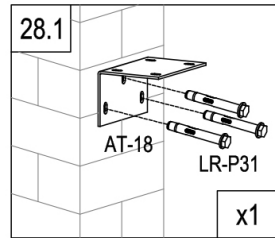
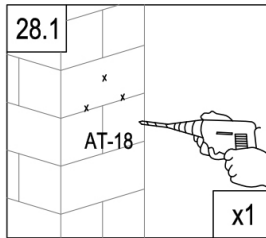
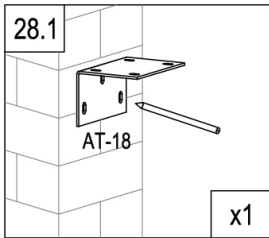
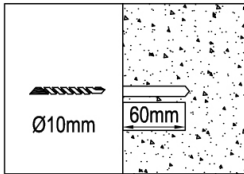
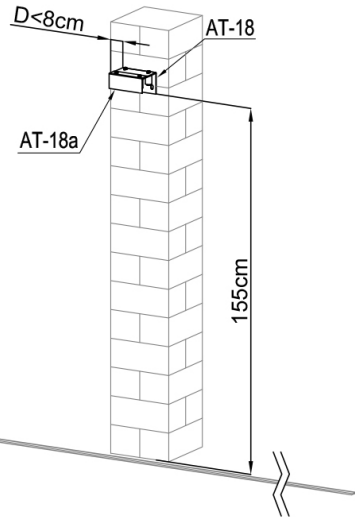

	AT-18	1
	AT-18a	1
	AT-20	4
	LR-P31	3

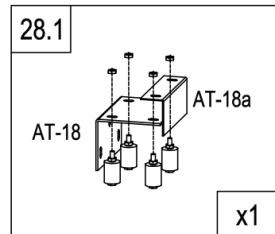
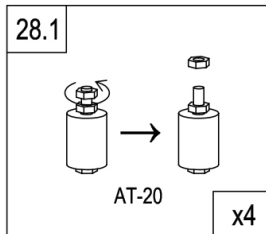

R

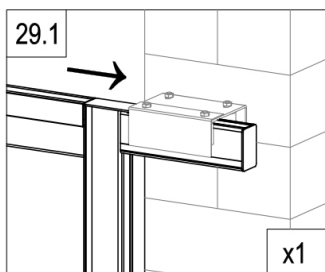
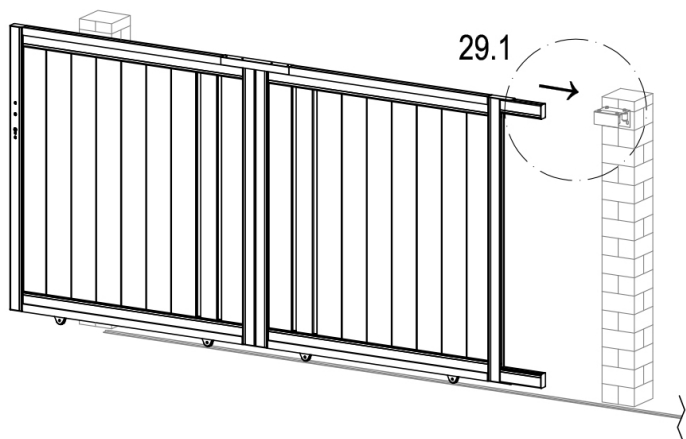

R

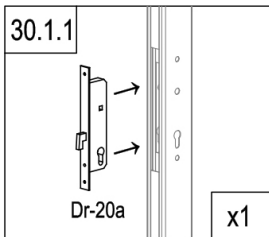
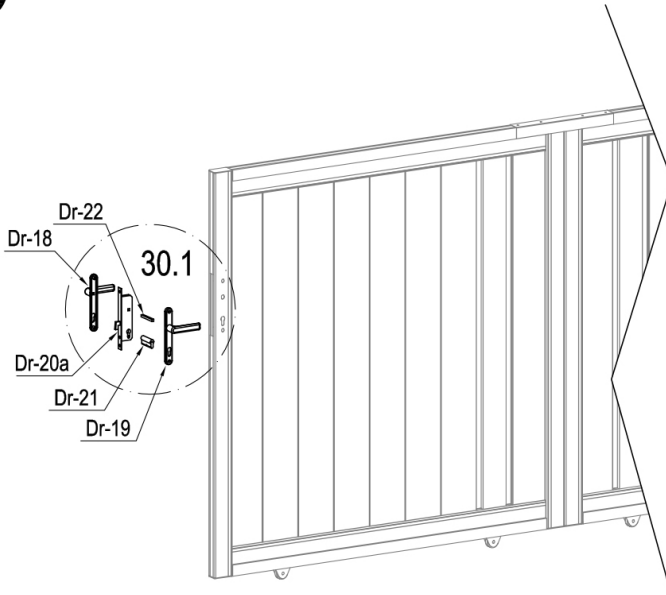

	Dr-20a	1
	Dr-21	1
	Dr-22	1
	Dr-25	1

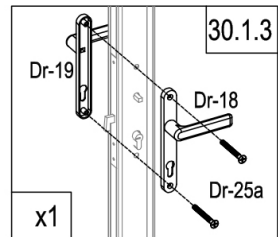
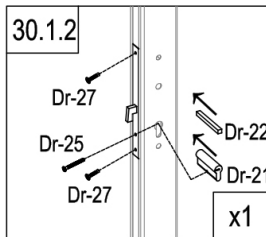

	Dr-18	1
	Dr-19	1
	Dr-25a	2
	Dr-27	2

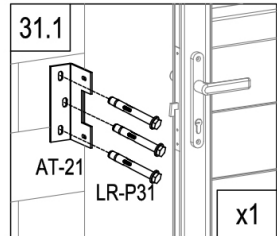
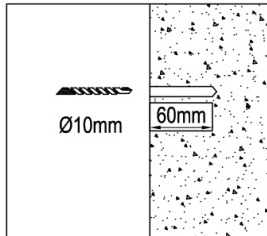
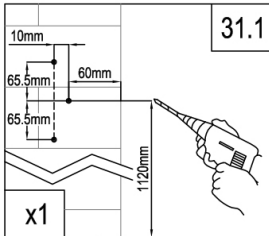
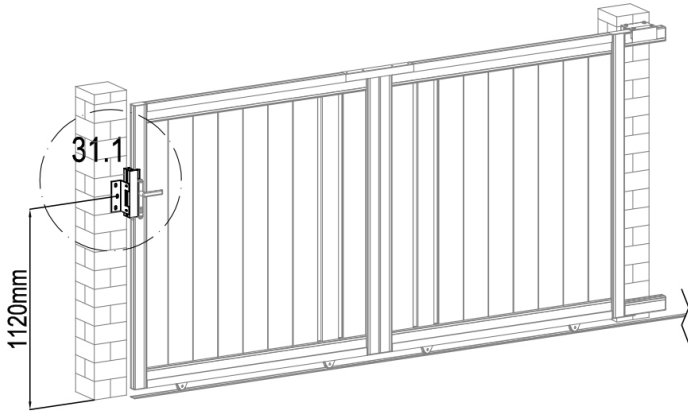

	AT-16	1
	AT-21	1
	LR-P36	2
	LR-P31	3
	AT-22J	3

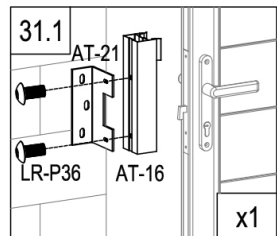
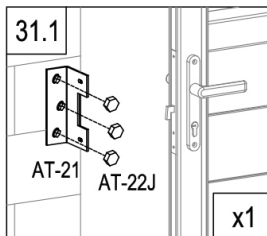

R

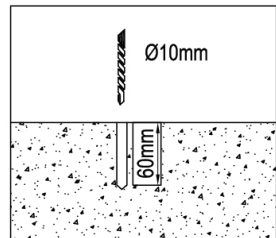
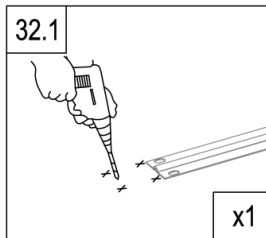
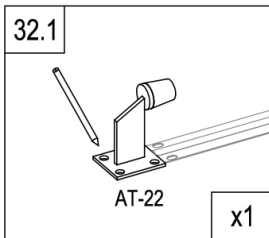
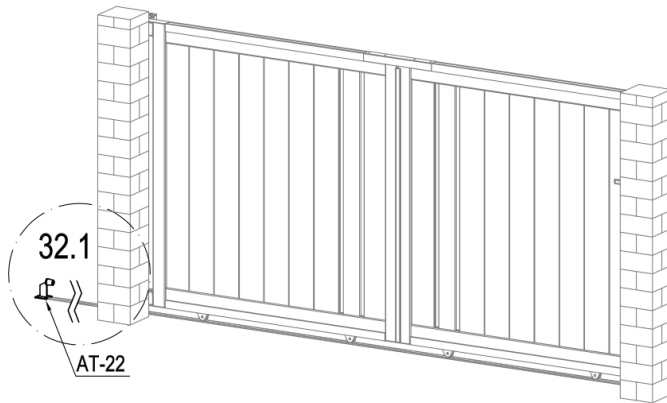

	AT-22	1
	LR-P31	4
	AT-22J	4

