

# CASANOVO

## GIONA 300C140

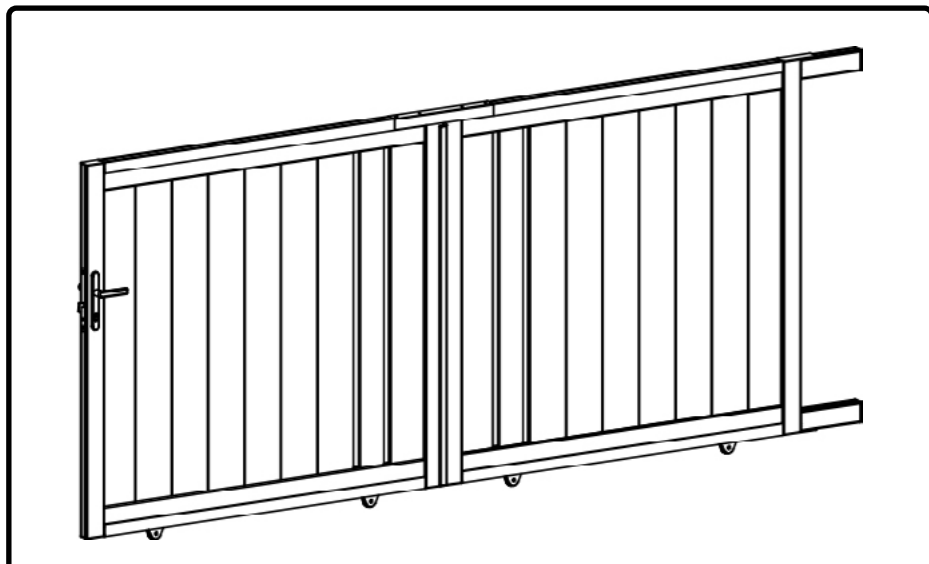

COM-000804 [x1]

COM-000806 [x1]

COM-000805 [x1]



7-8H



X 2



INSTRUCTION MANUAL / NOTICE DE MONTAGE / MONTAGEANLEITUNG / MANUAL DE MONTAJE / MANUAL DE MONTAGEM / MANUALE DI MONTAGGIO /  
MONTAGEHANDLEIDING / INSTRUKCJA MONTAŻU / KÄYTTÖOHJEET / BRUKSANVISNING / BRUGSANVISNING / INSTRUCȚIUNI DE ASAMBLARE /  
NAVODILA ZA SESTAVLJANJE / NÁVOD NA MONTÁŽ / ÖSSZESZERELÉSI ÚTMUTATÓ / NÁVOD K MONTÁŽI / UPUTE ZA INSTALACIJU /  
ΟΔΗΓΙΕΣ ΣΥΝΑΡΜΟΛΟΓΗΣΗΣ / SURINKIMO INSTRUKCIJOS / MONTŽAS INSTRUKCIJAS

Ext.

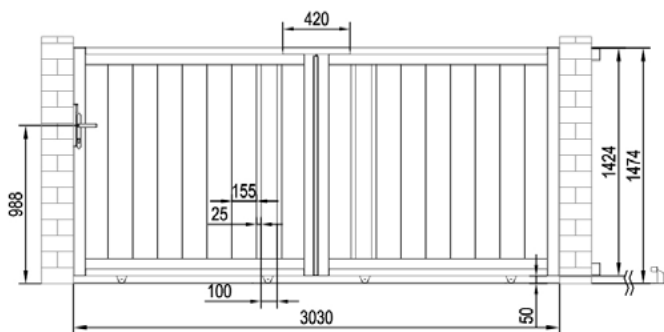

Int.

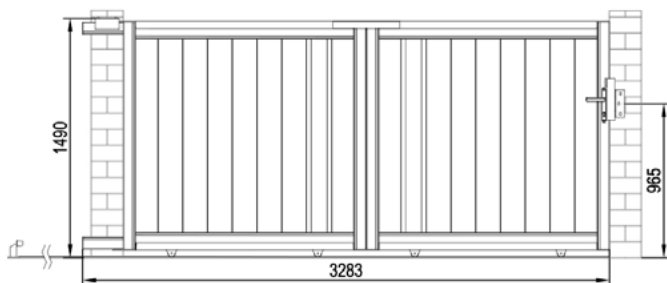

# CASANOVO

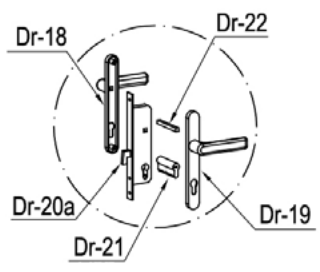
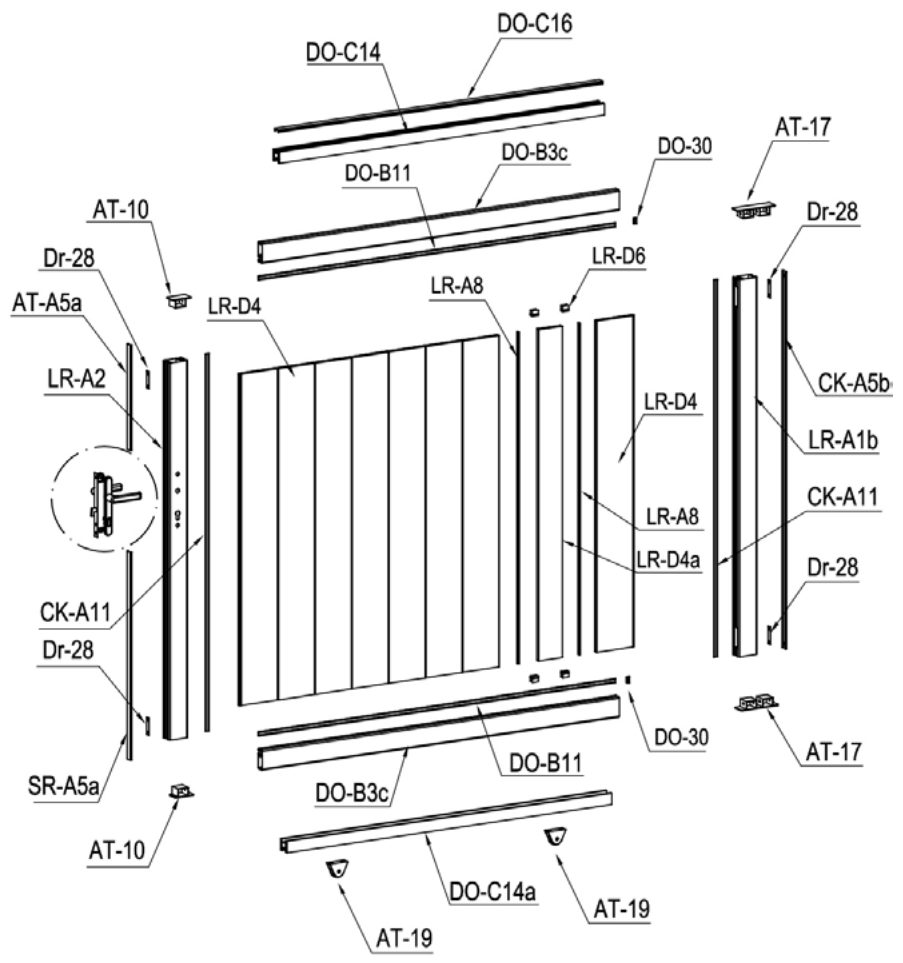

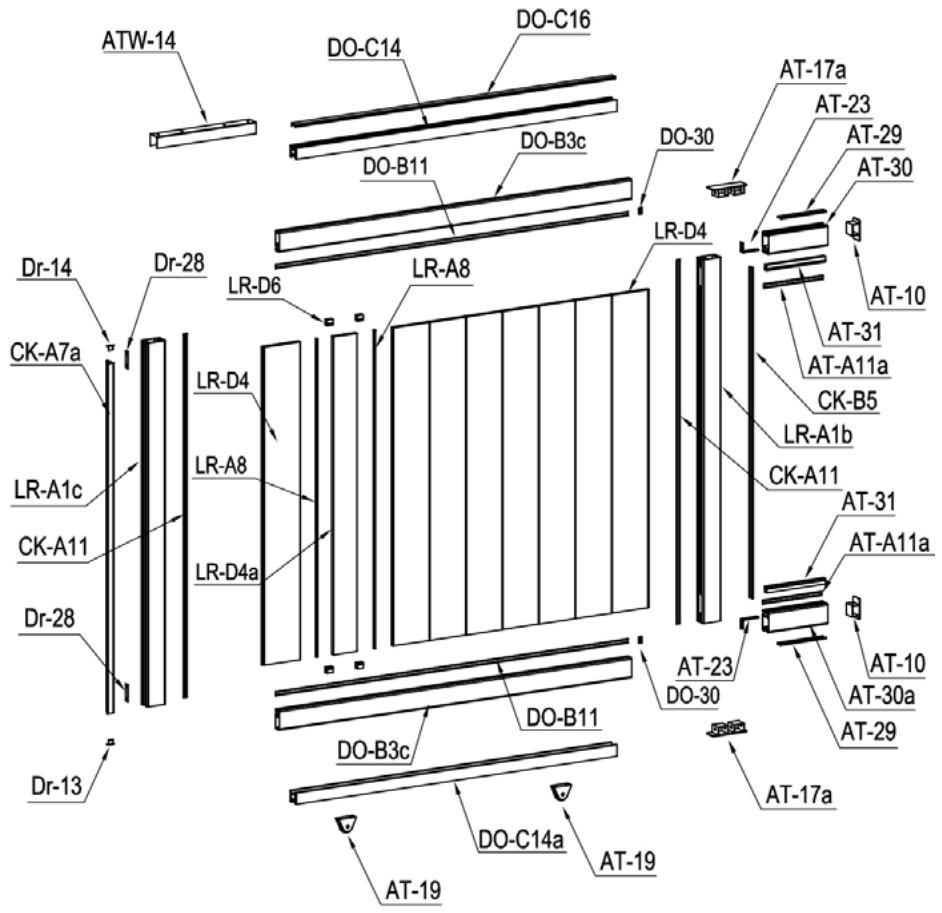

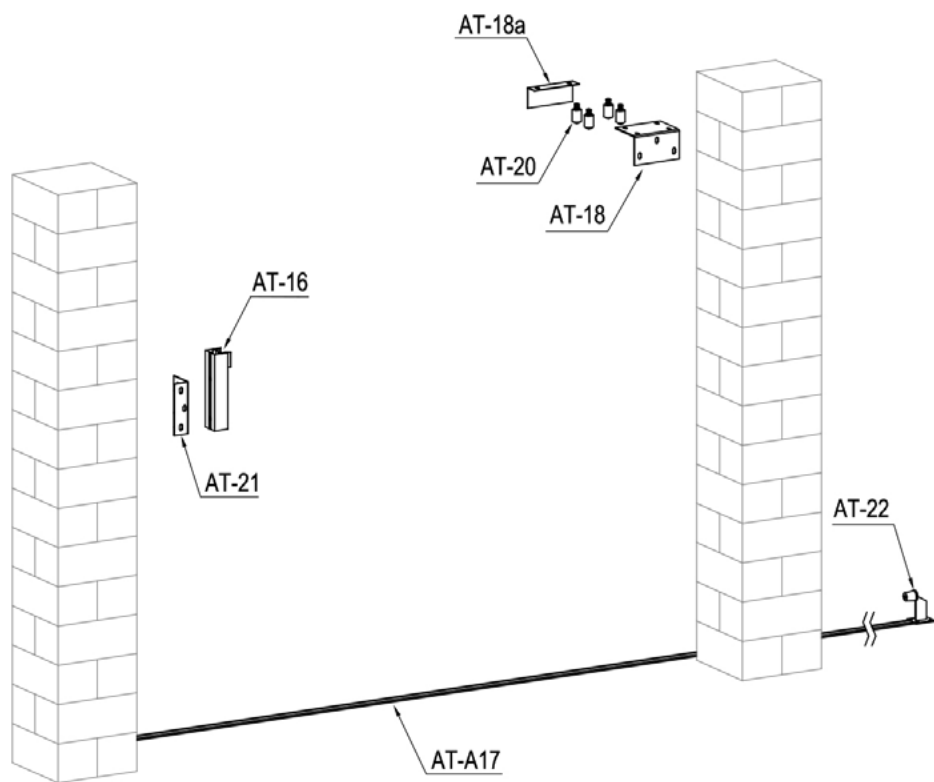













































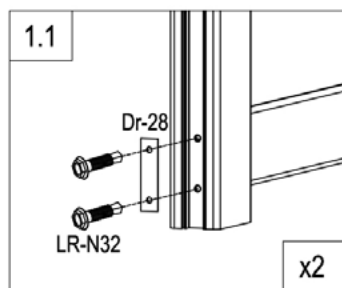
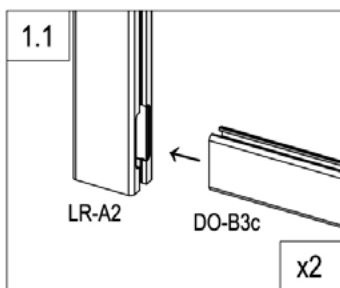
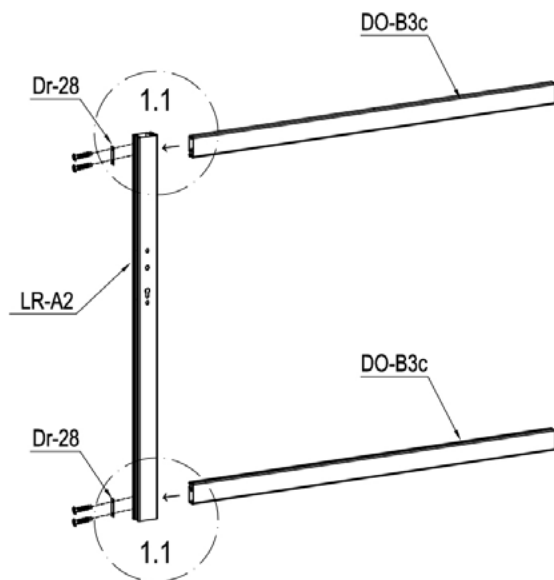



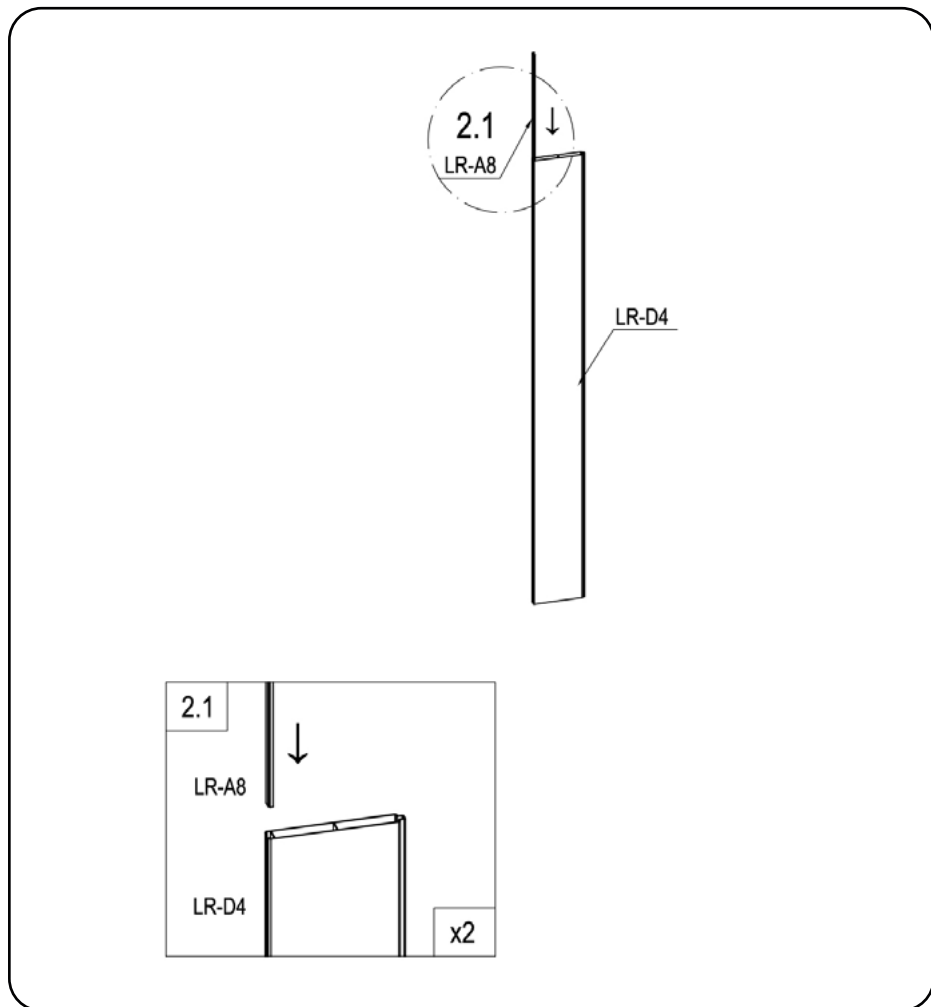



IMAGE	NO.	L.(mm)	QTY	IMAGE	NO.	L.(mm)	QTY
	LR-A1b	1418	2		DO-30		4
	LR-A1c	1418	1		AT-18	150	1
	LR-A2	1418	1		AT-18a	150	1
	AT-30	250	1		ATW-14		1
	AT-30a	250	1		AT-19		4
	DO-B3c	1492	4		AT-20		4
	LR-D4	1245	16		AT-21		1
	LR-D4a	1245	2		AT-22		1
	CK-A5b	1418	1		AT-23		2
	CK-B5	1293	1		Dr-18		1
	AT-A5a	395.5	1		Dr-19		1
	SR-A5a	782	1		Dr-20a		1
	AT-29	193	2		Dr-21		1
	CK-A11	1418	4		Dr-22		1
	AT-A11a	250	2		Dr-25		1
	DO-B11	1492	4		Dr-25a		2
	AT-31	250	2		Dr-27		2
	LR-D6	25	8		Dr-28		6
	LR-A8	1245	4		AT-22J		7
	CK-A7a	1365	1		LR-N30		4
	DO-C14	1358	2		LR-N31		10
	DO-C14a	1358	2		LR-N32		28
	DO-C16	1357	2		LR-N33		4
	AT-16		1		LR-N34		12
	AT-A17	1212	5		LR-N35		42
	AT-17		2		LR-N36		2
	AT-17a		2		LR-N37		8
	AT-10		4		LR-N38		40
	Dr-13		1				
	Dr-14		1				



	LR-A2	1
	DO-B3c	2
	Dr-28	2
	LR-N32	4



**X2**



	LR-A8	2
	LR-D4	2

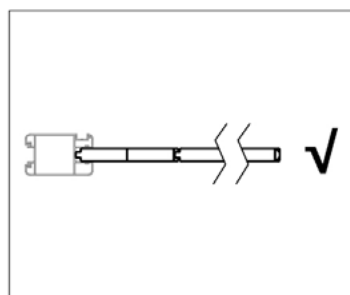
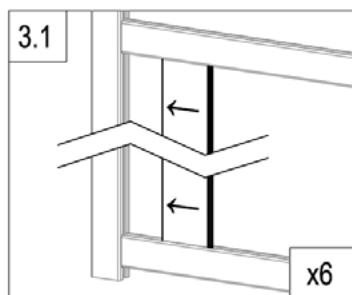
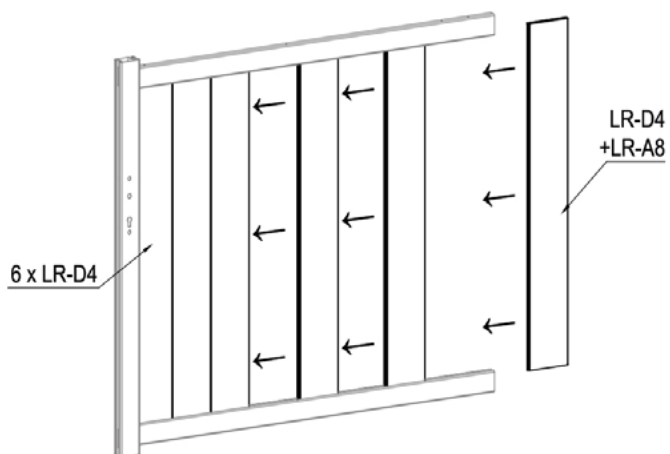



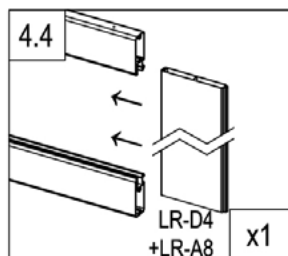
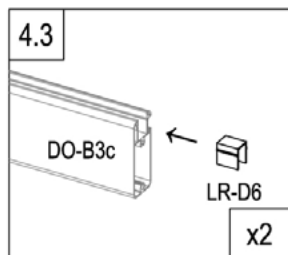
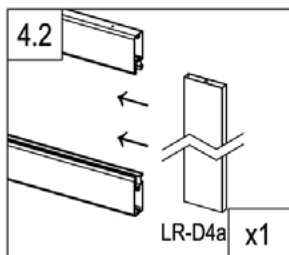
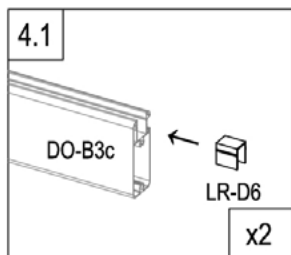
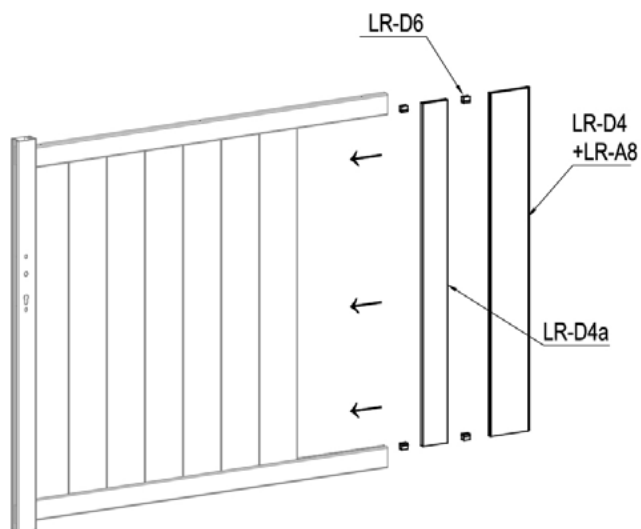



	LR-D4	6
---	-------	---

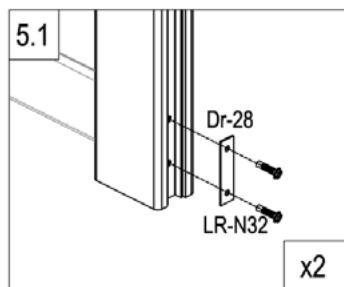
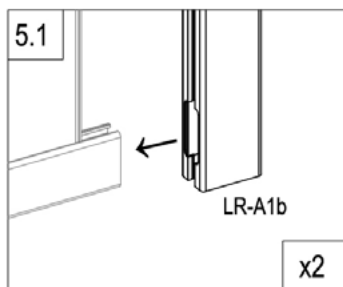
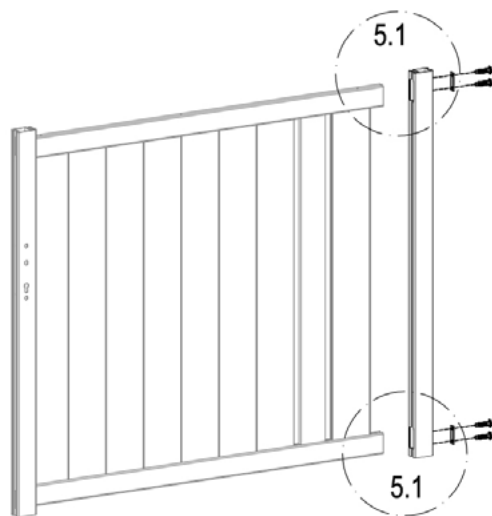



	LR-D4a	1
	LR-D6	4

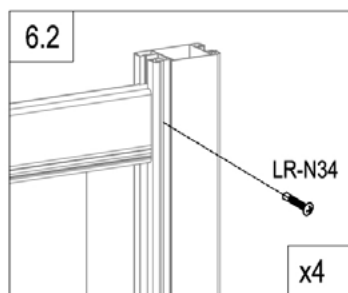
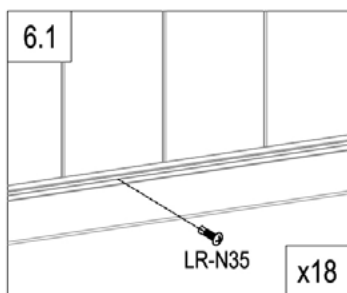
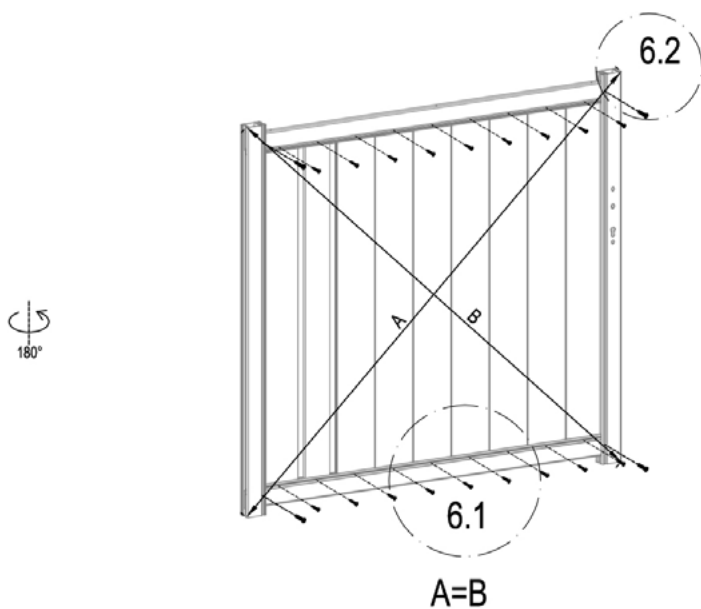

	LR-A1b	1
	Dr-28	2
	LR-N32	4



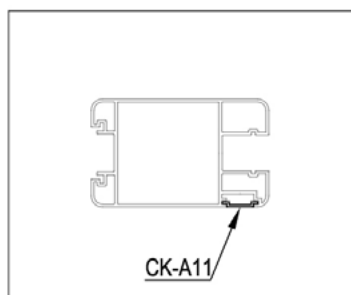
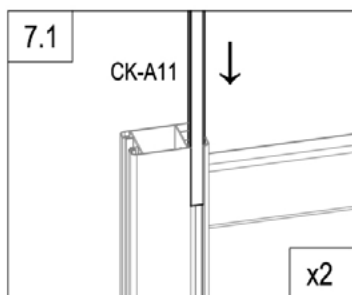
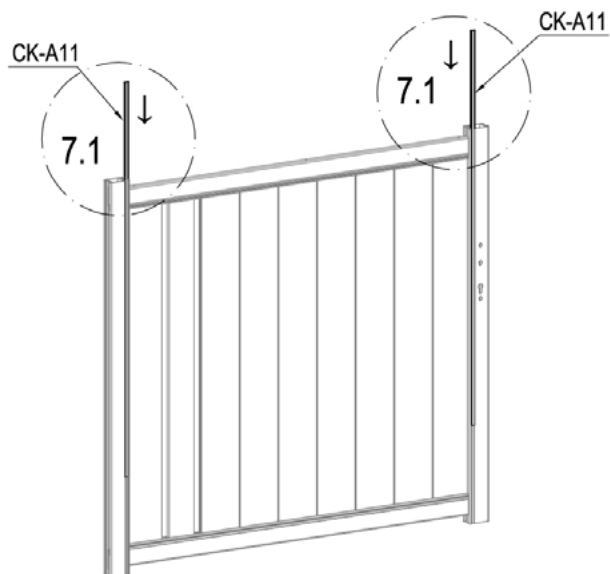

	LR-N35	18
	LR-N34	4

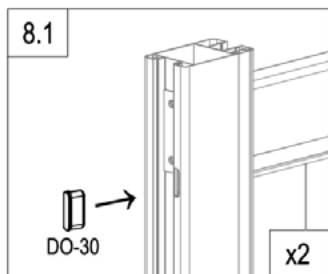
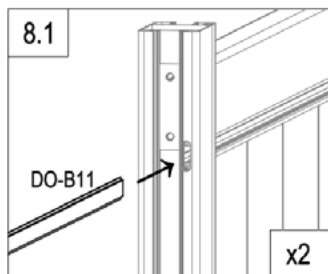
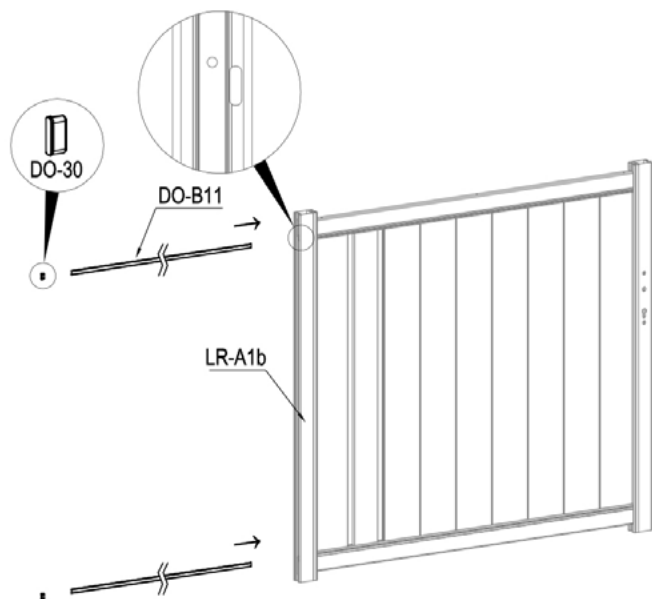

	CK-A11	2
---	--------	---



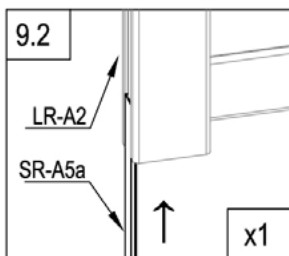
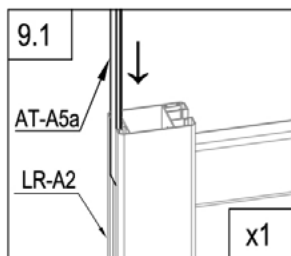
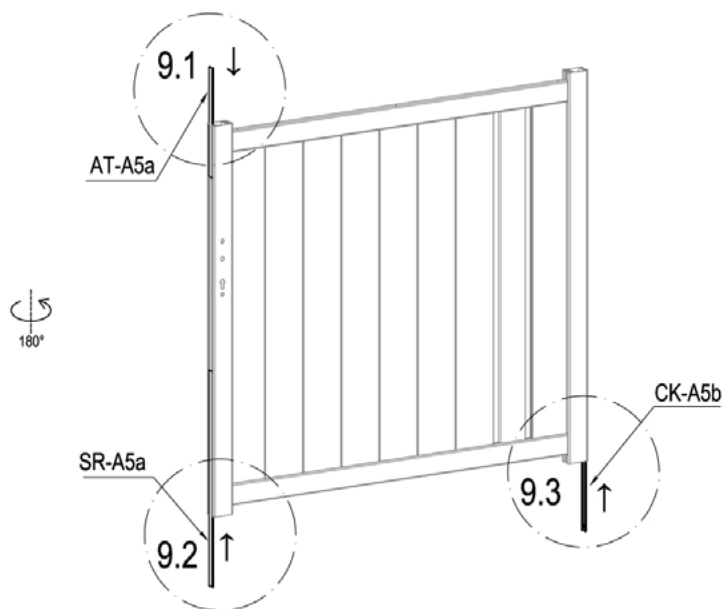

	DO-B11	2
	DO-30	2

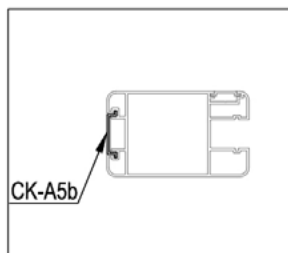

	CK-A5b	1
	AT-A5a	1
	SR-A5a	1

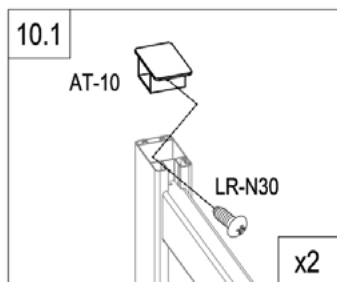
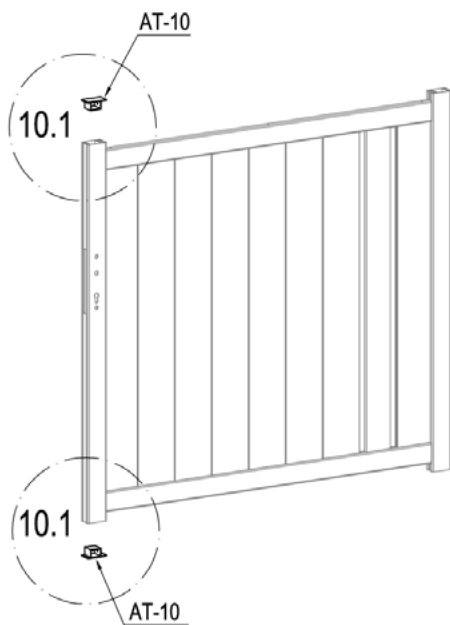





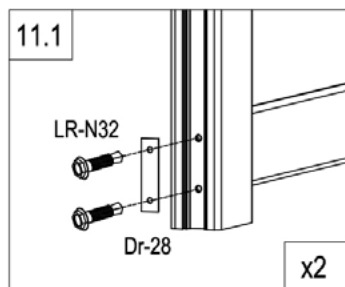
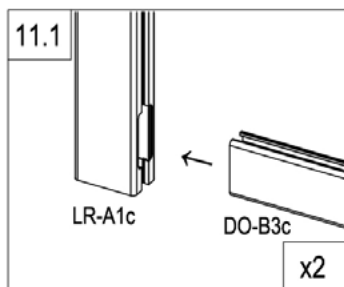
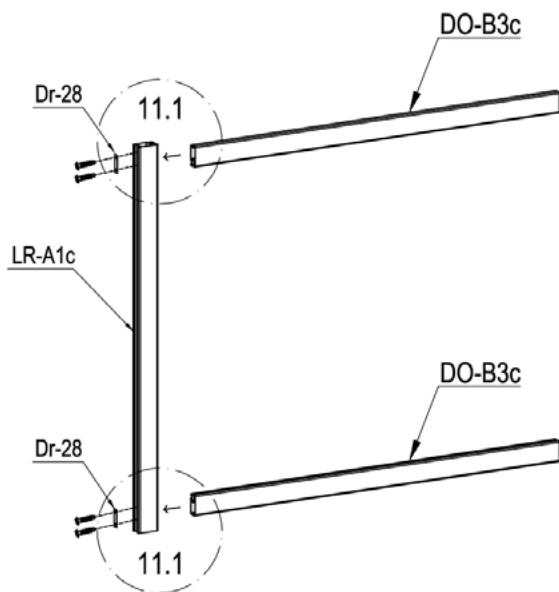

	AT-10	2
	LR-N30	2







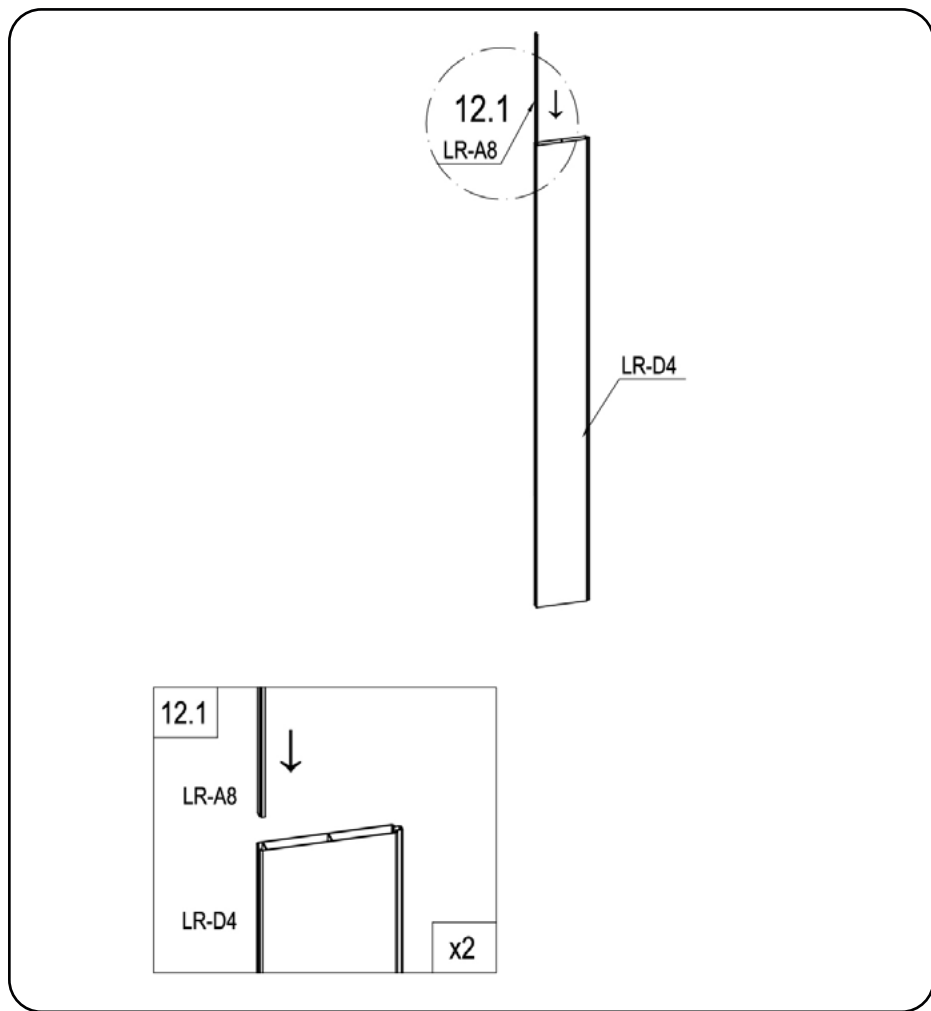

	LR-A1c	1
	DO-B3c	2
	Dr-28	2
	LR-N32	4



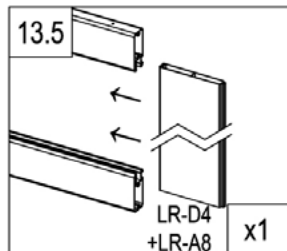
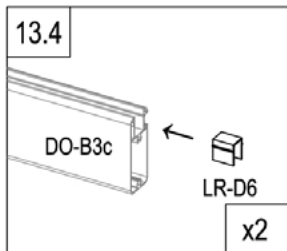
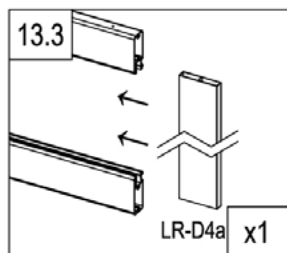
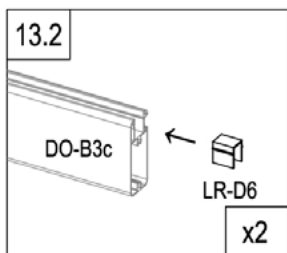
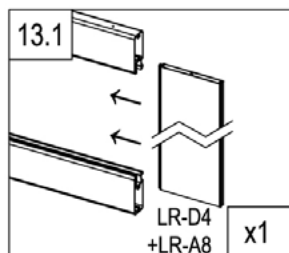
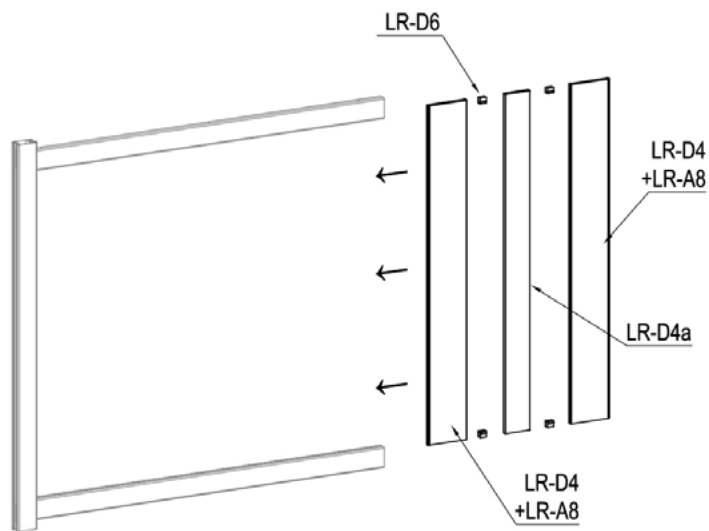

**X2**

	LR-A8	2
	LR-D4	2



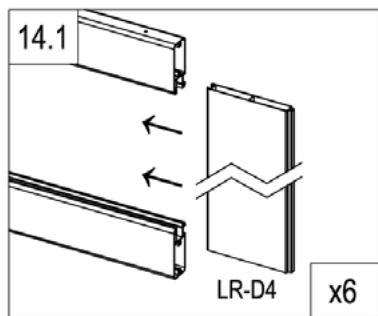
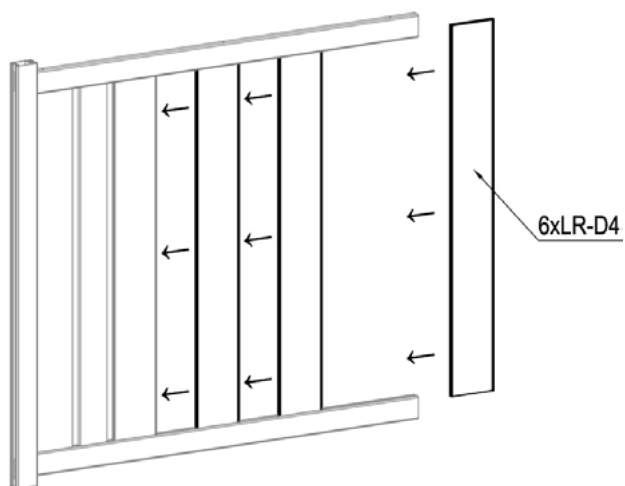

	LR-D4a	1
	LR-D6	4



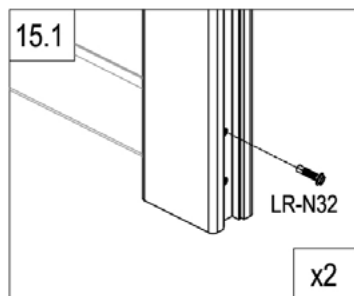
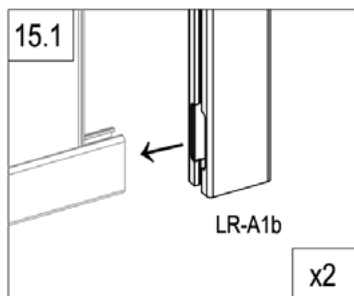
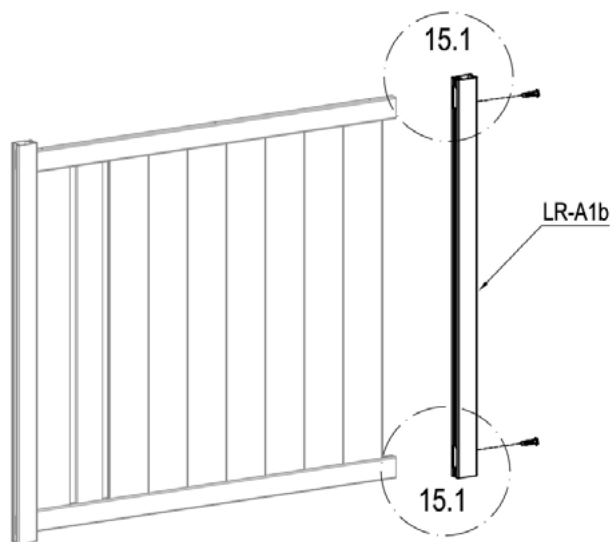

	LR-D4	6
---	-------	---

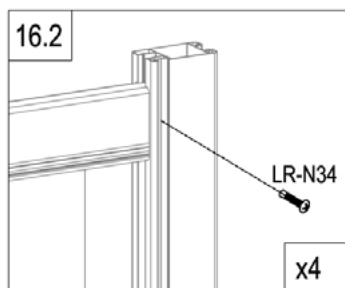
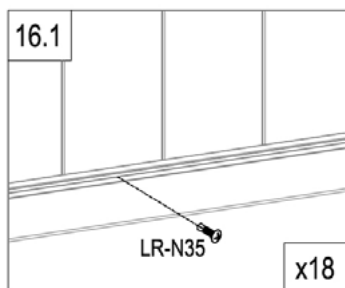
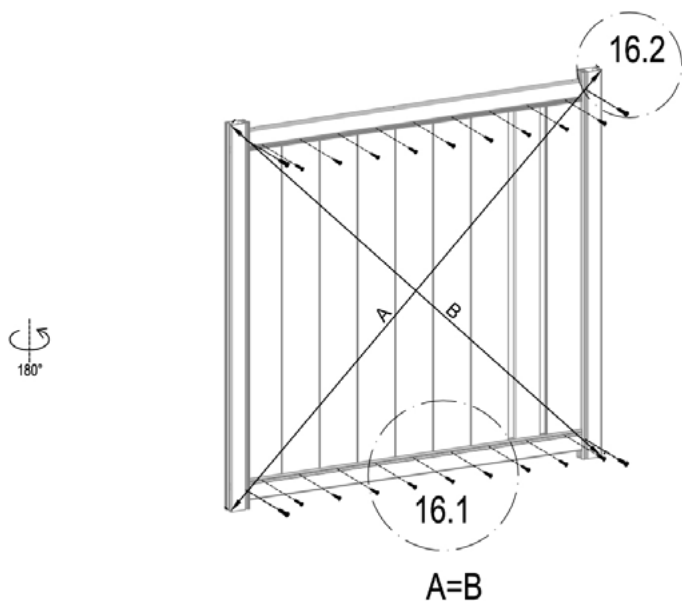

	LR-A1b	1
	LR-N32	2



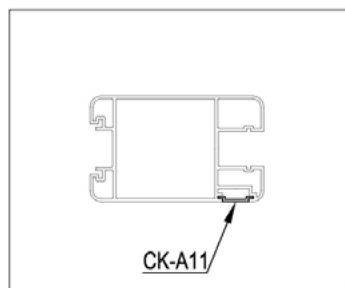
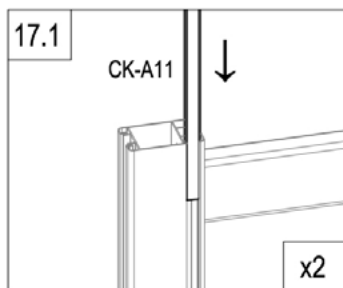
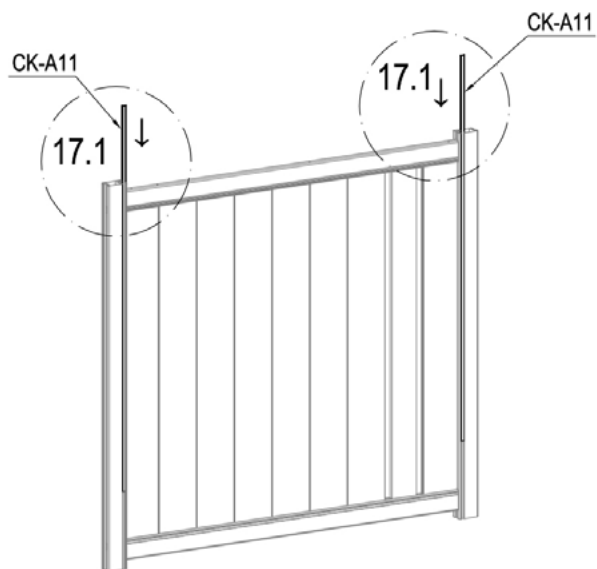

	LR-N35	18
	LR-N34	4

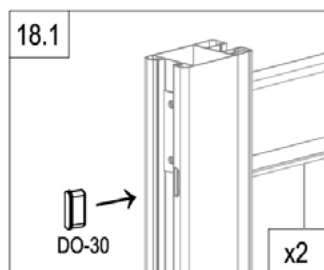
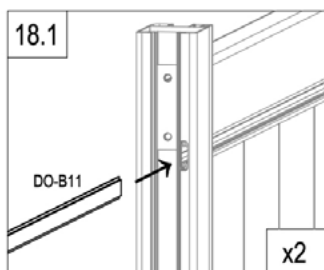
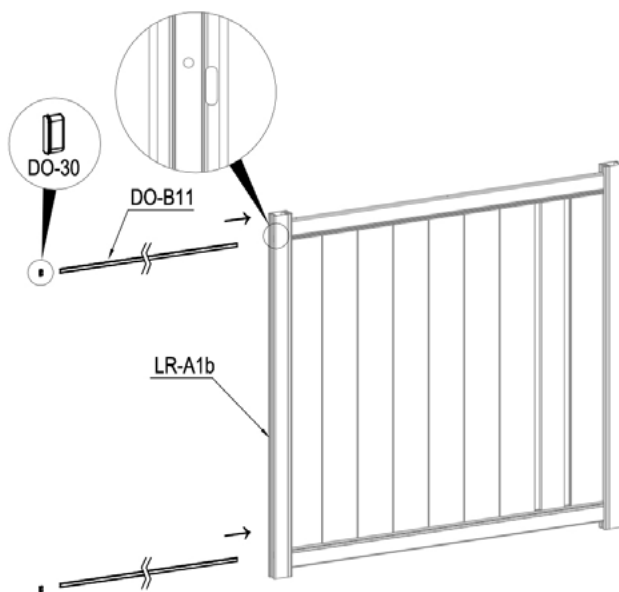

	CK-A11	2
---	--------	---



	DO-B11	2
	DO-30	2



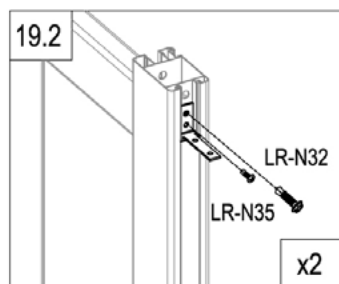
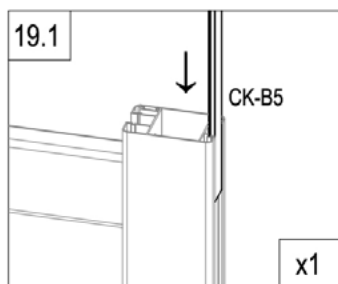
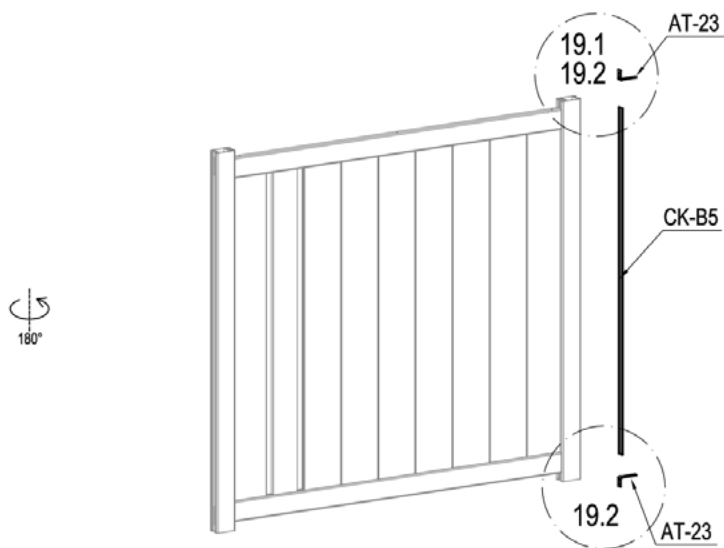



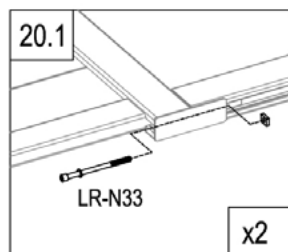
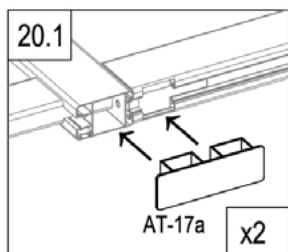
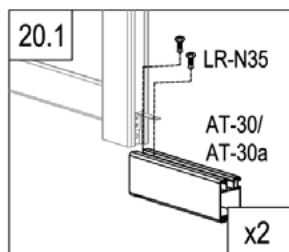
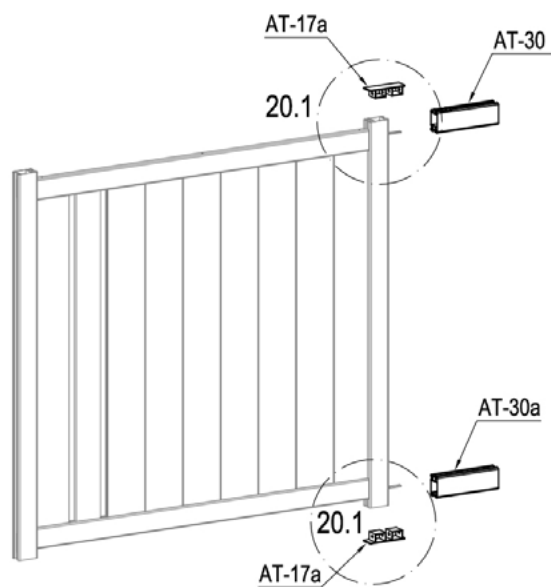

	CK-B5	1
	AT-23	2
	LR-N32	2
	LR-N35	2



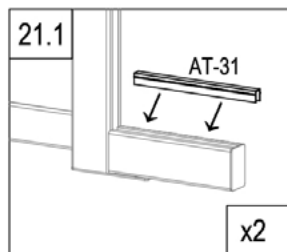
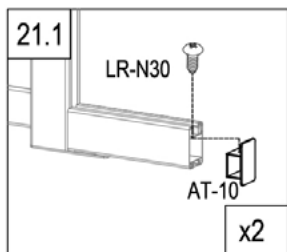
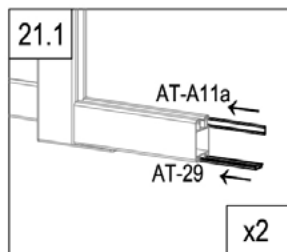
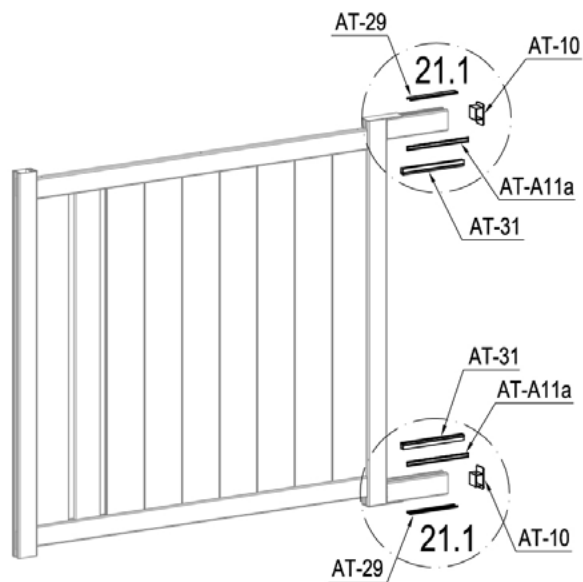

	AT-30	1
	AT-30a	1
	AT-17a	2



	LR-N33	2
	LR-N35	4

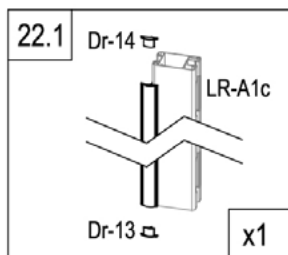
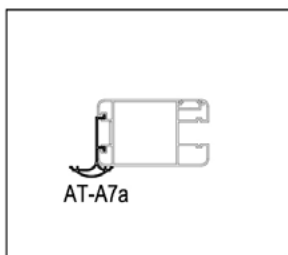
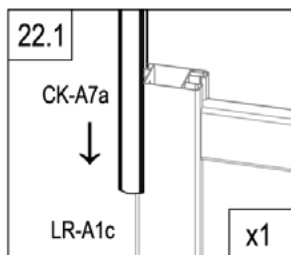
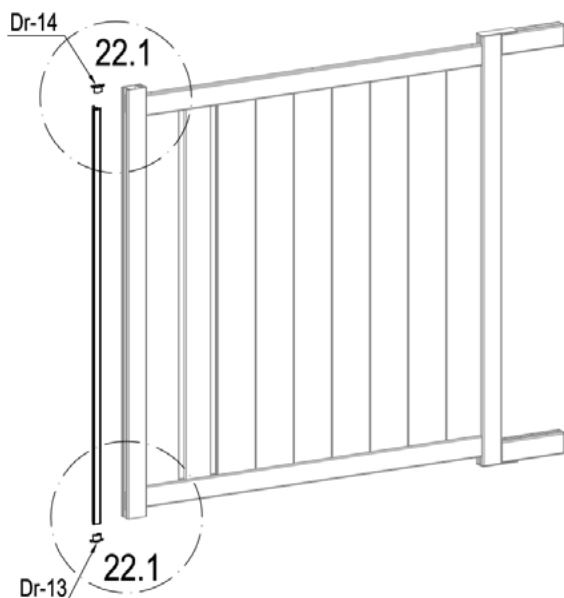

	AT-29	2
	AT-A11a	2
	AT-31	2

	AT-10	2
	LR-N30	2



	CK-A7a	1
	Dr-13	1
	Dr-14	1

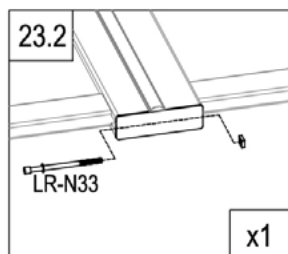
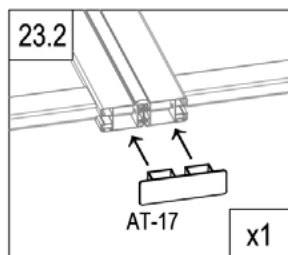
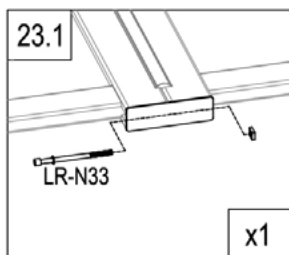
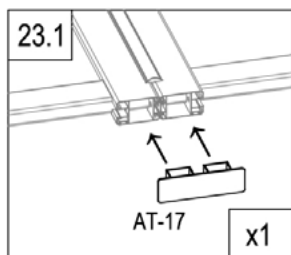
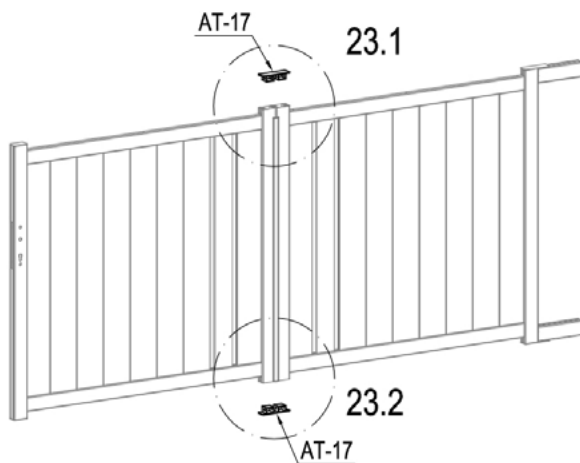

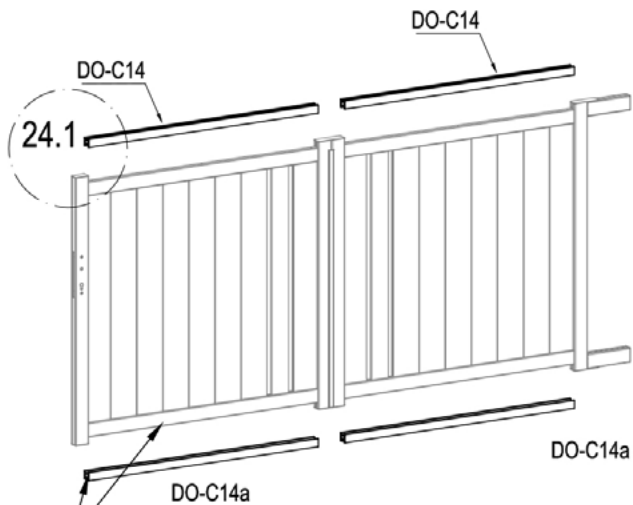

	AT-17	2
	LR-N33	2



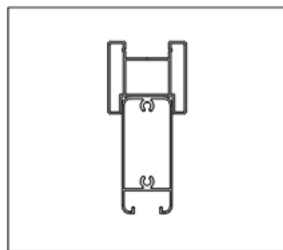
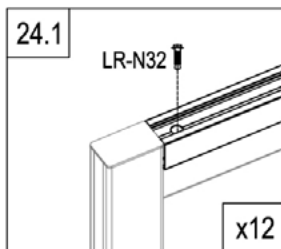
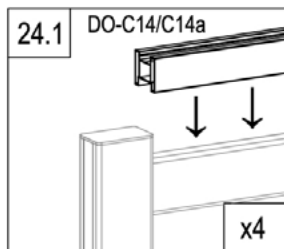

EN: These parts are made for connecting your gate's automation  
 FR: Ces pièces sont faites pour relier l'automatisation de votre portail  
 DE: Diese Teile sind für den Anschluss der Automatisierung Ihres Tores vorgesehen  
 ES: Estas piezas están hechas para conectar la automatización de su puerta  
 PT: Estas peças são feitas para ligar a automatização do seu portão  
 IT: Queste parti sono realizzate per collegare l'automazione del vostro cancello  
 NL: Deze onderdelen zijn gemaakt voor het aansluiten van de automatisering van uw poort.  
 PL: Te części są wykonane do podłączenia automatyki bramy.



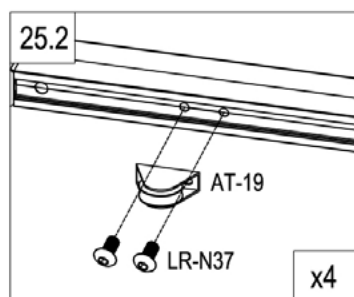
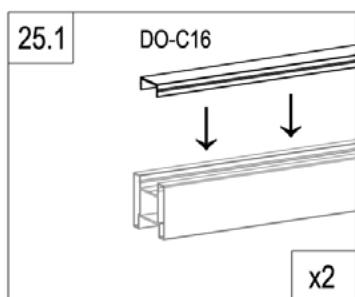
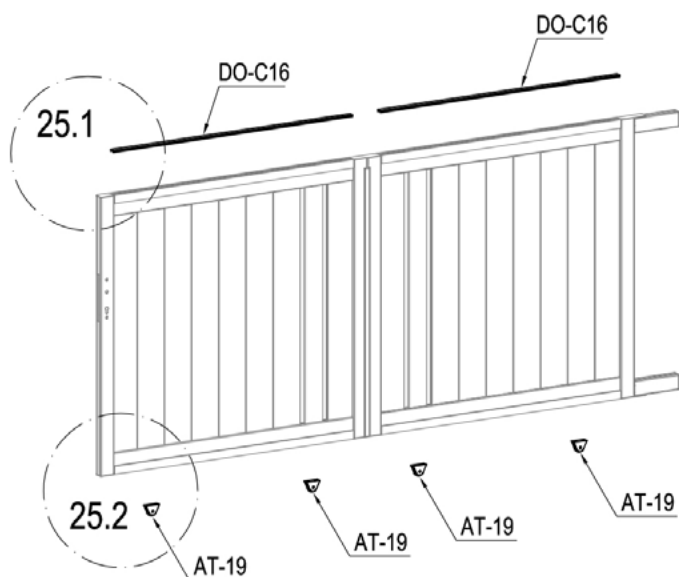

	DO-C14	2
	DO-C14a	2
	LR-N32	12

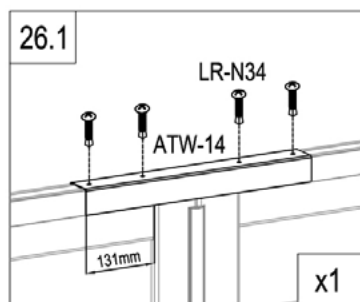
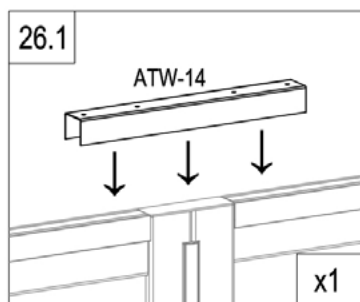
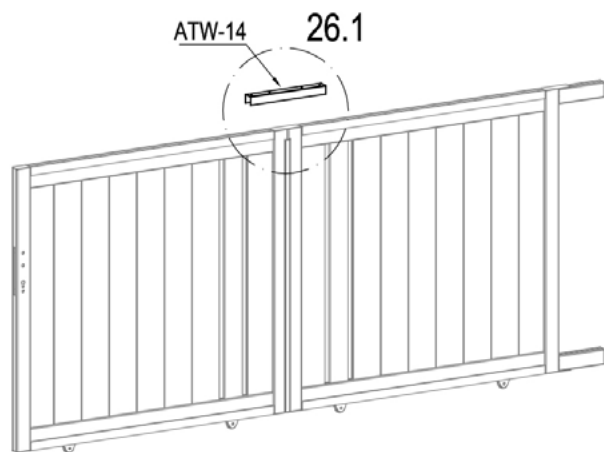

	DO-C16	2
	AT-19	4
	LR-N37	8



	ATW-14	1
	LR-N34	4



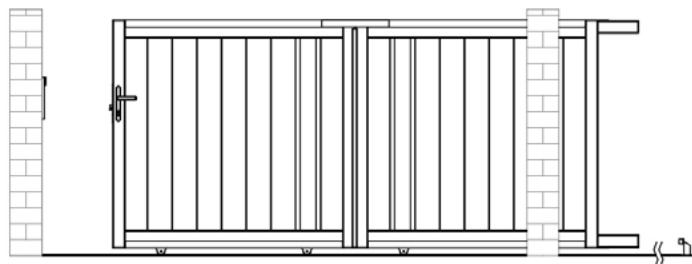

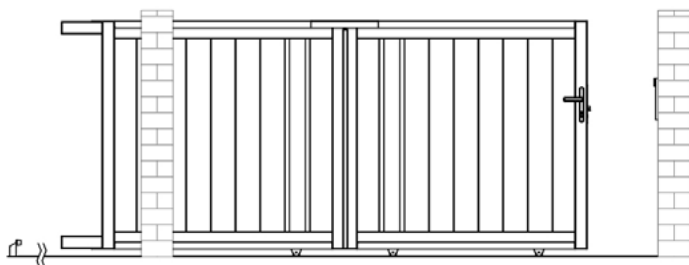

**L** : P27~32

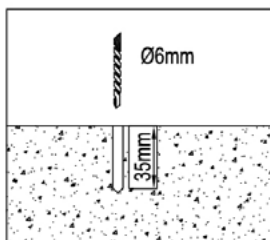
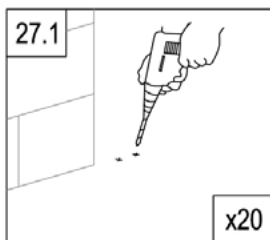
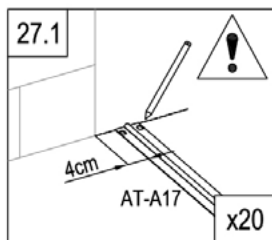
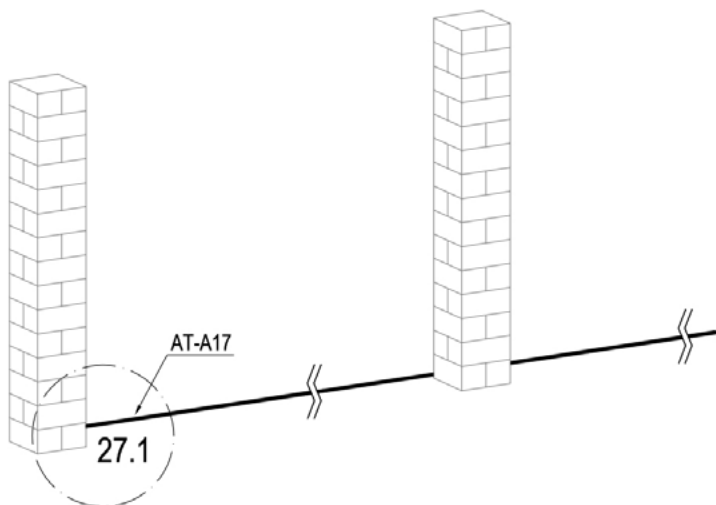

**R** : P33~38

L



	AT-A17	5
	LR-N38	40

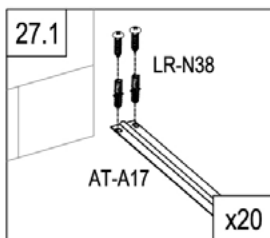

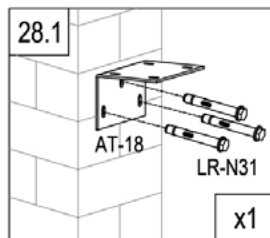
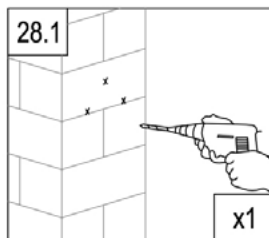
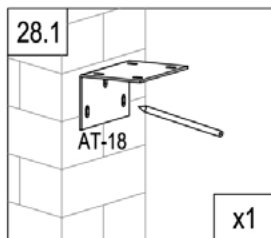
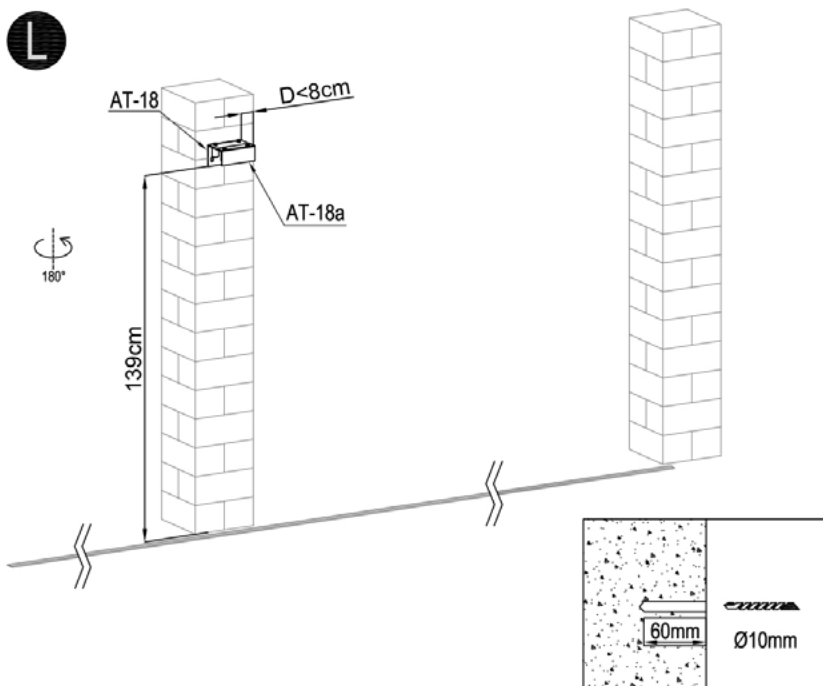

	AT-18	1
	AT-18a	1
	AT-20	4
	LR-N31	3

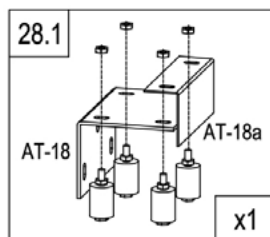
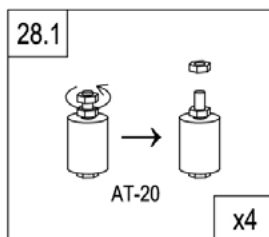

L

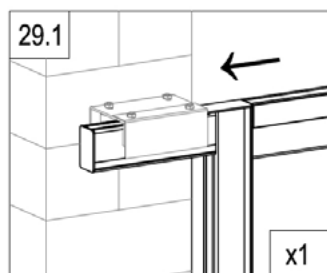
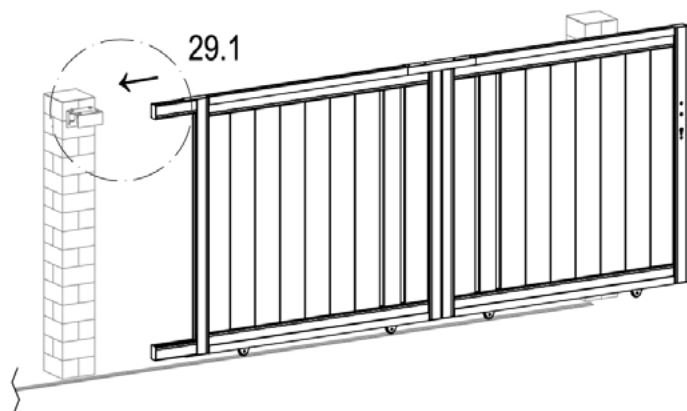

L

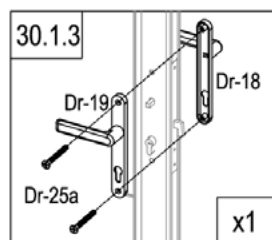
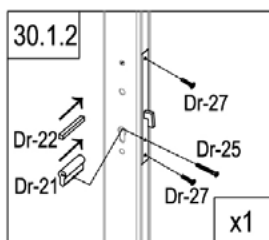
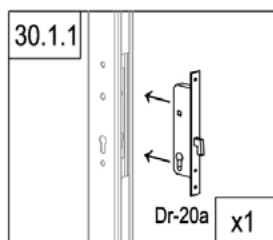
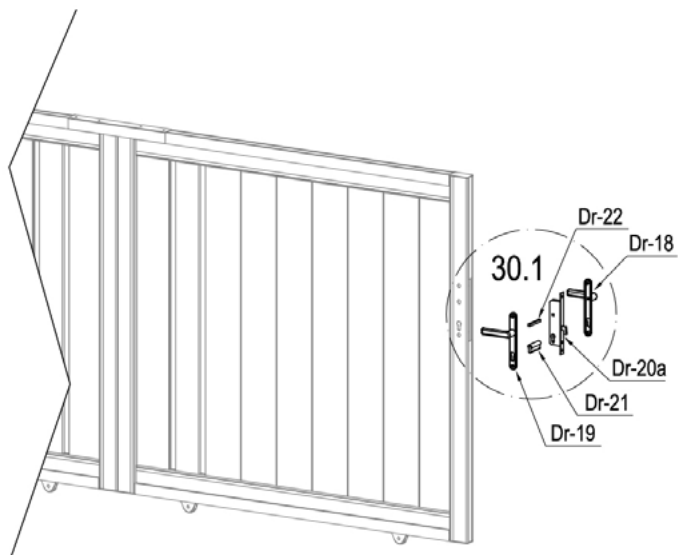

	Dr-20a	1
	Dr-21	1
	Dr-22	1
	Dr-25	1

	Dr-18	1
	Dr-19	1
	Dr-25a	2
	Dr-27	2

**L**

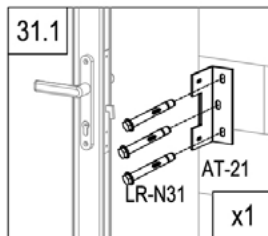
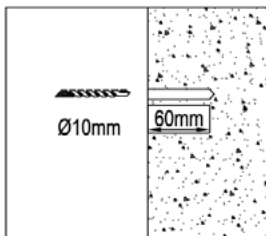
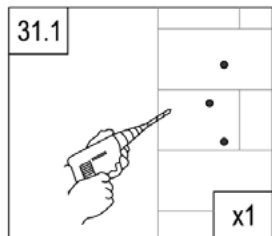
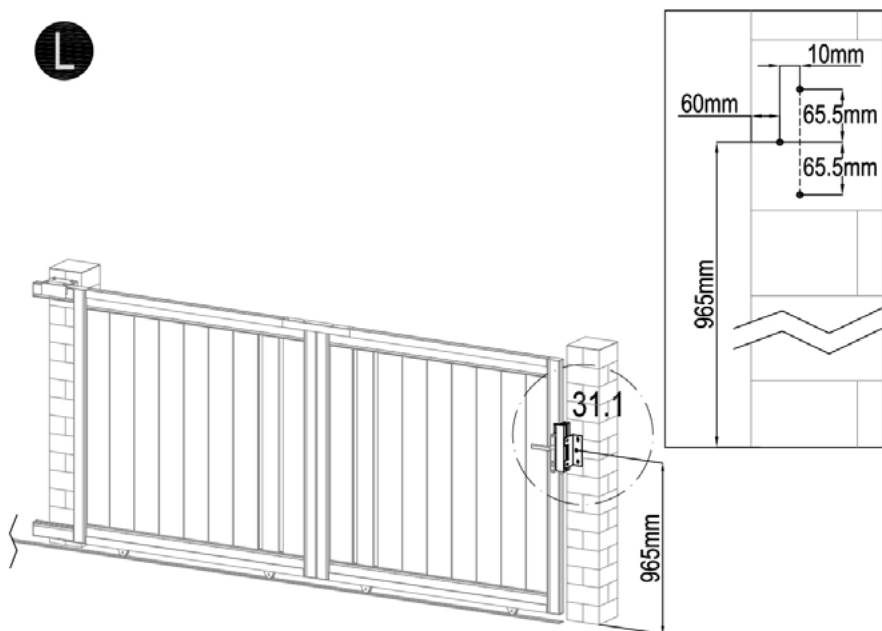

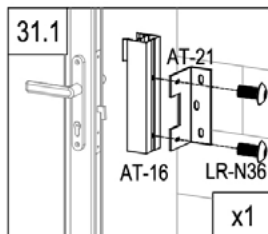
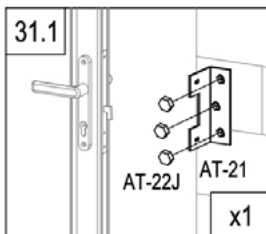

	AT-16	1
	AT-21	1
	LR-N36	2
	LR-N31	3
	AT-22J	3

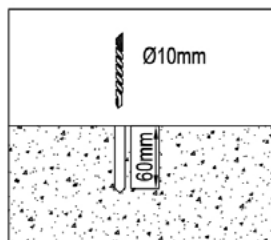
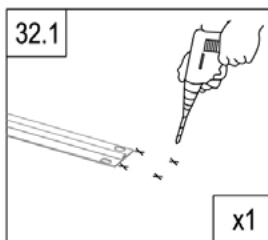
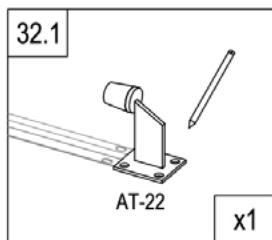
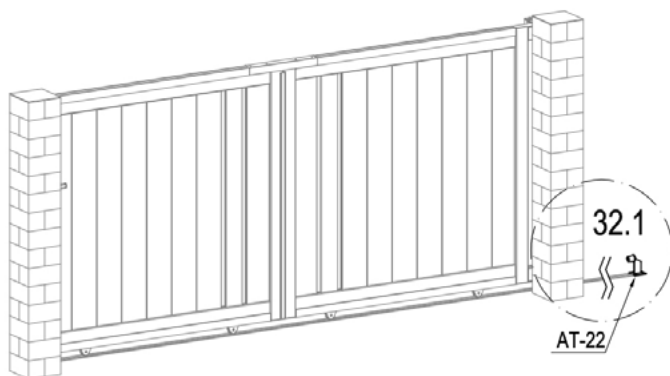

L



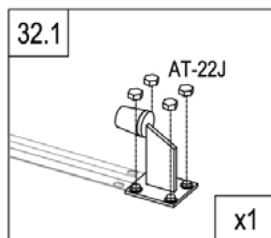
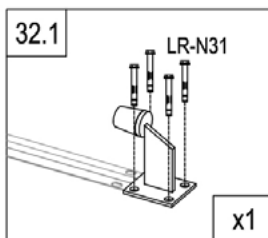

	AT-22	1
	LR-N31	4
	AT-22J	4

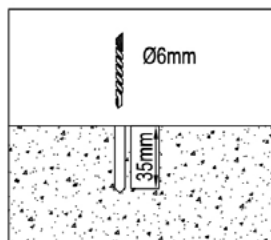
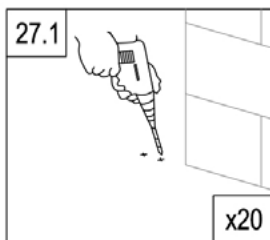
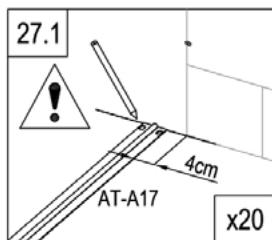
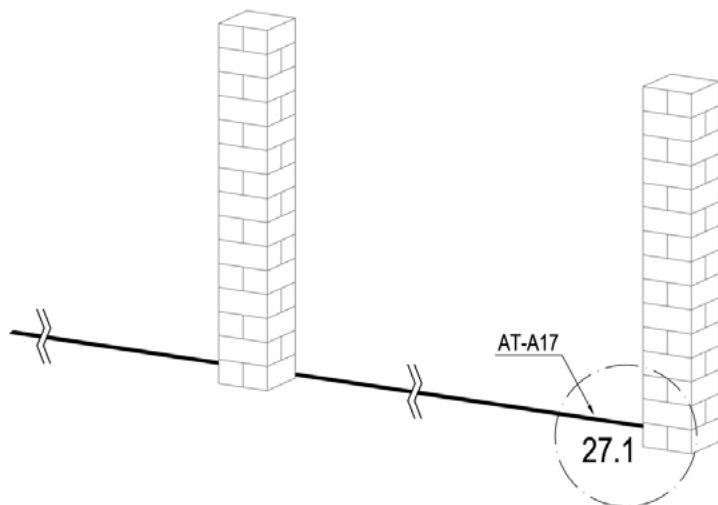

R



	AT-A17	5
	LR-N38	40

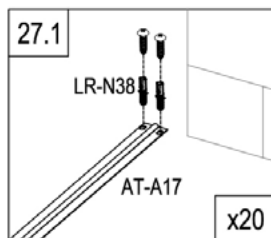



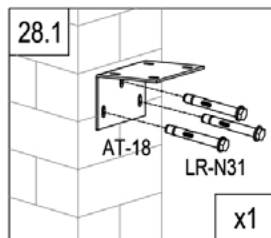
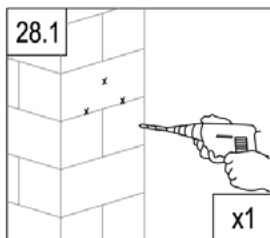
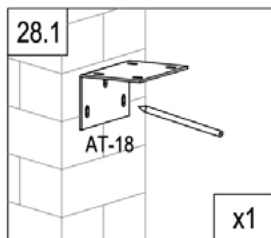
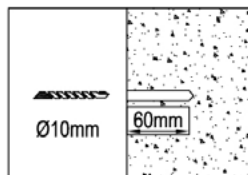
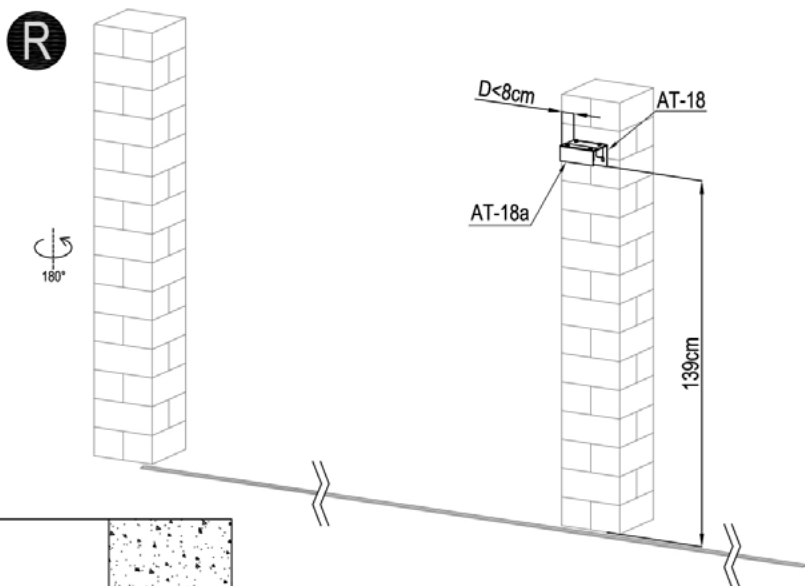

	AT-18	1
	AT-18a	1
	AT-20	4
	LR-N31	3

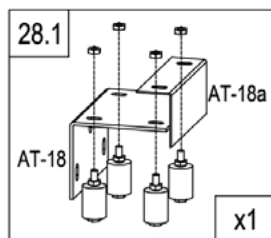
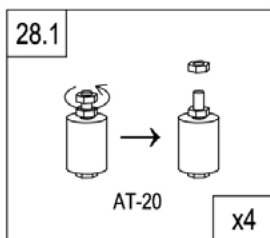

R

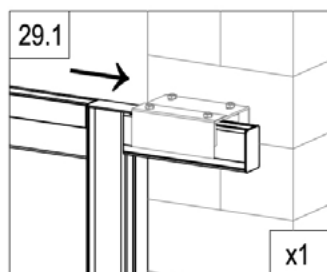
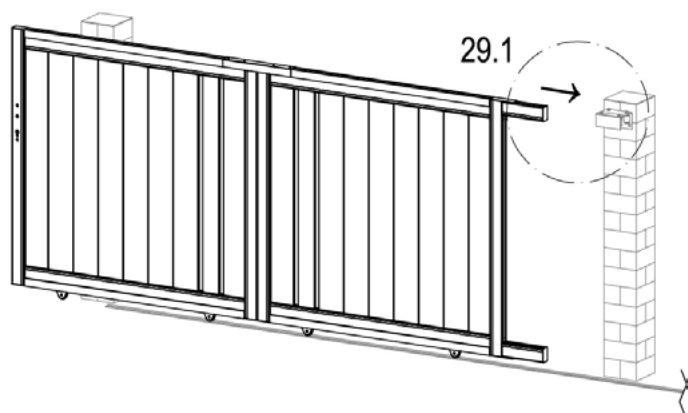

R

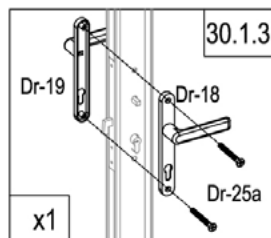
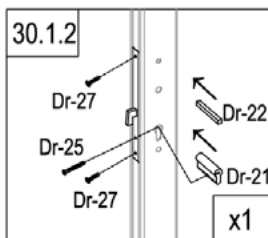
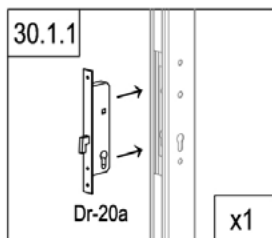
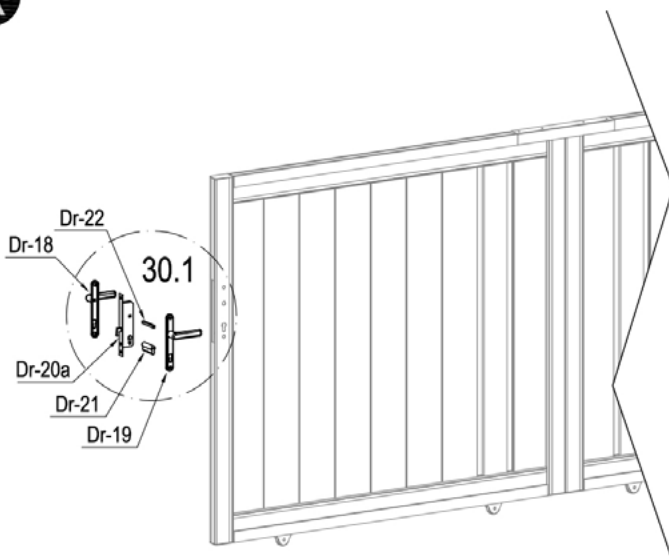

	Dr-20a	1
	Dr-21	1
	Dr-22	1
	Dr-25	1

	Dr-18	1
	Dr-19	1
	Dr-25a	2
	Dr-27	2

R

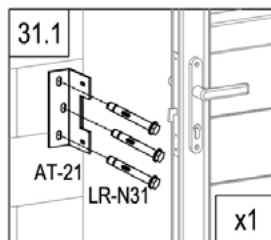
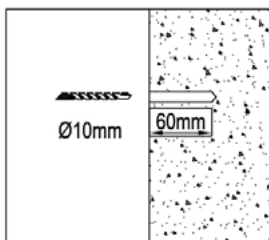
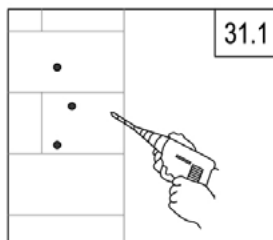
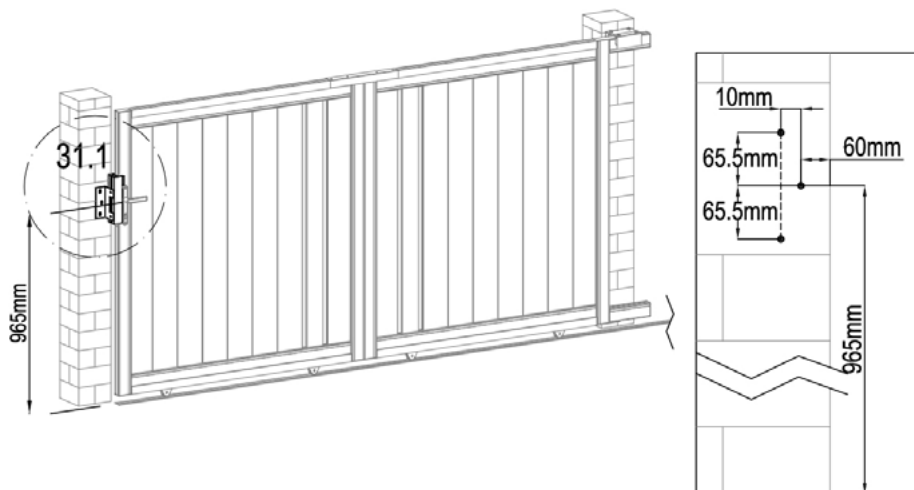

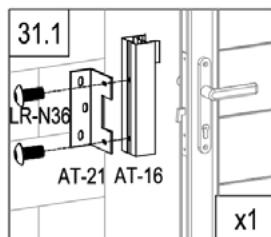
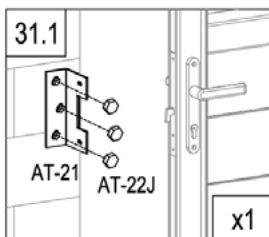

	AT-16	1
	AT-21	1
	LR-N36	2
	LR-N31	3
	AT-22J	3

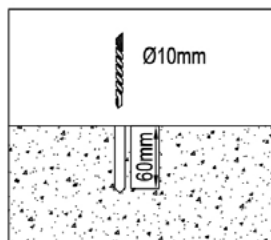
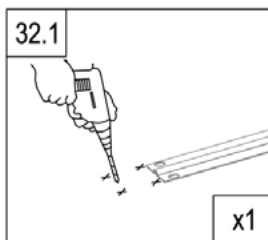
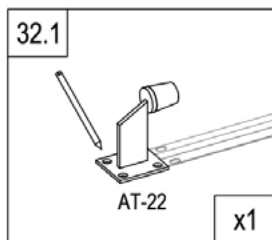
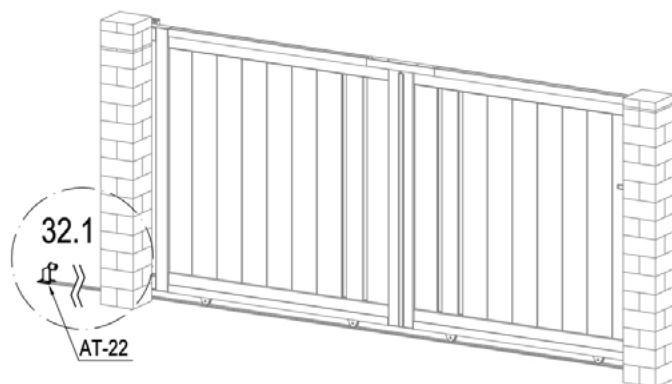

R



	AT-22	1
	LR-N31	4
	AT-22J	4

