

# CASANOVO

## GIONA 350C140

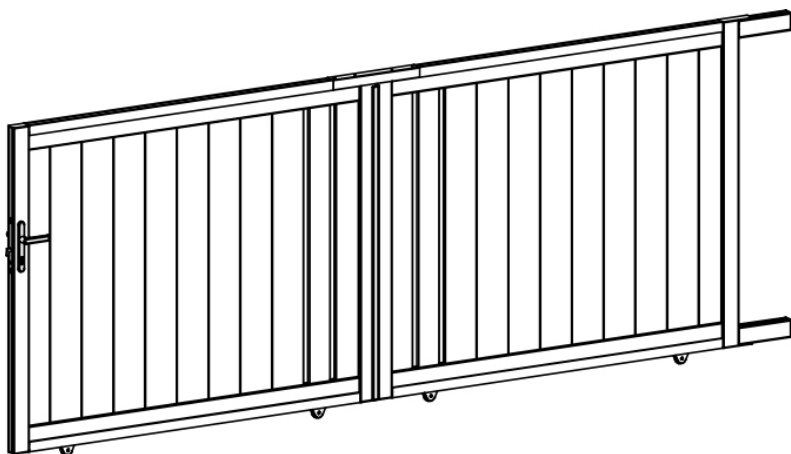

COM-000810 [x1]

COM-000813 [x1]

COM-000811 [x1]



7-8H



X 2



INSTRUCTION MANUAL / NOTICE DE MONTAGE / MONTAGEANLEITUNG / MANUAL DE MONTAJE / MANUAL DE MONTAGEM / MANUALE DI MONTAGGIO /  
MONTAGEHANDLEIDING / INSTRUKCJA MONTAŻU / KÄYTTÖOHJEET / BRUKSANVISNING / BRUGSANVISNING / INSTRUCIUNI DE ASAMBLARE /  
NAVODILA ZA SESTAVLJANJE / NÁVOD NA MONTÁŽ / ÖSSZESZERELÉSI ÚTMUTATÓ / NÁVOD K MONTÁŽI / UPUTE ZA INSTALACIJU /  
ΟΔΗΓΙΕΣ ΣΥΝΑΡΜΟΛΟΓΗΣΗΣ / SURINKIMO INSTRUKCIJOS / MONTĀŽAS INSTRUKCIJAS

Ext.

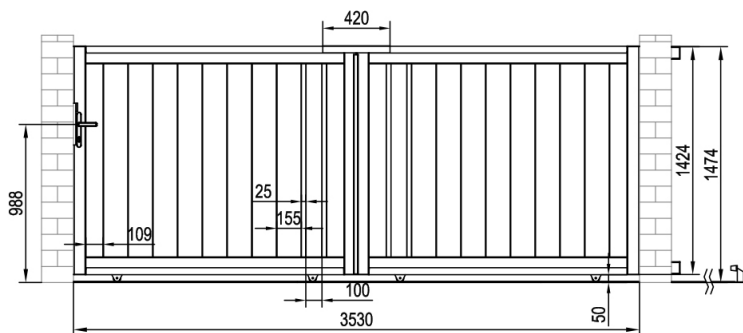

Int.

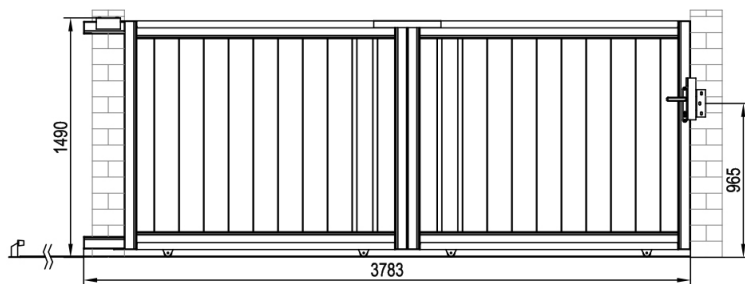

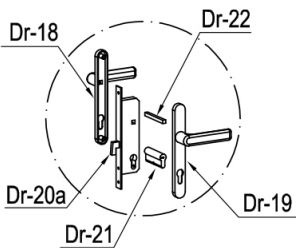
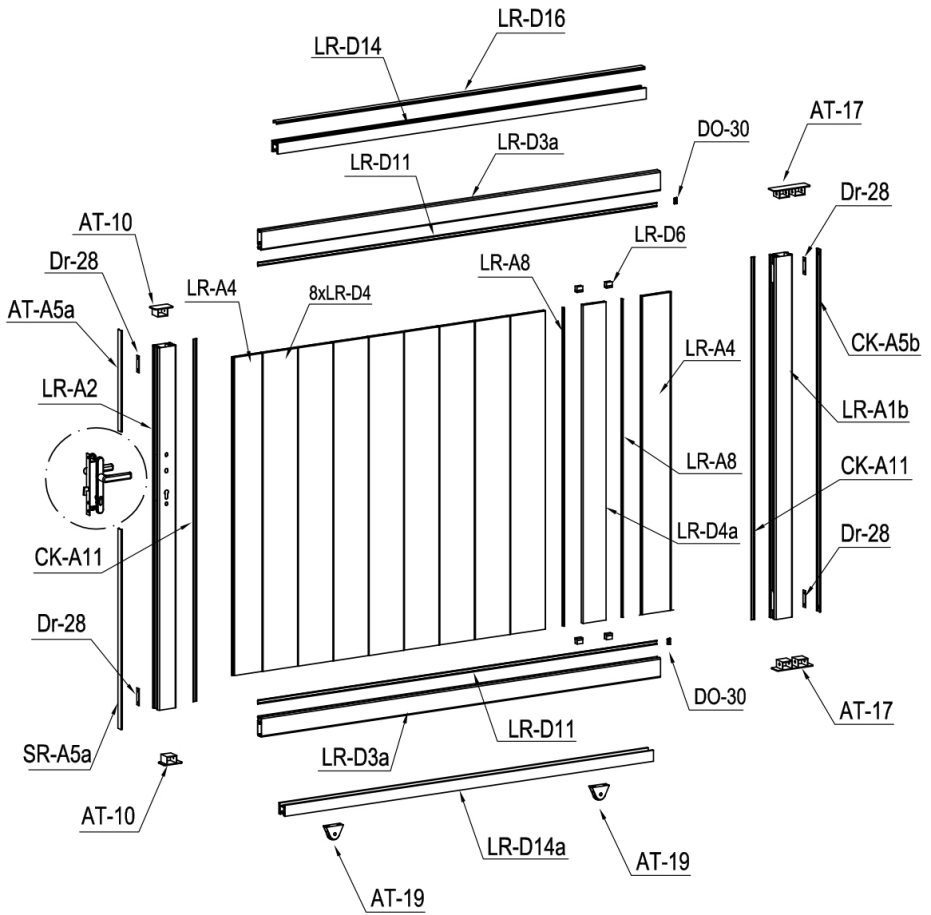

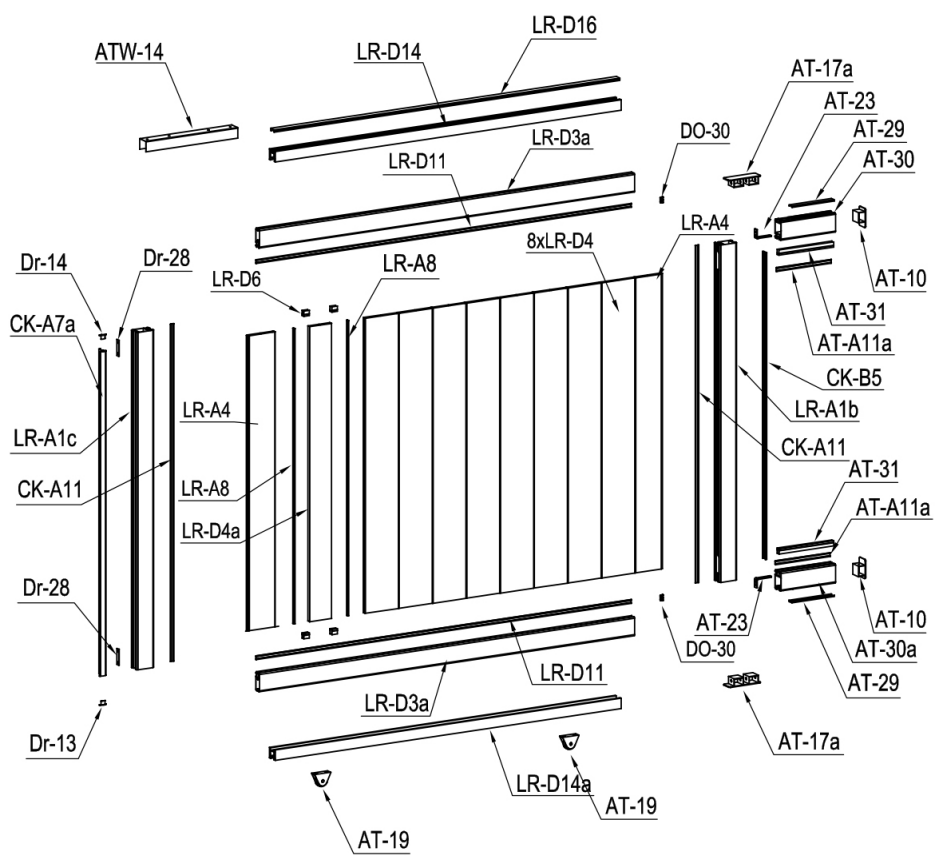

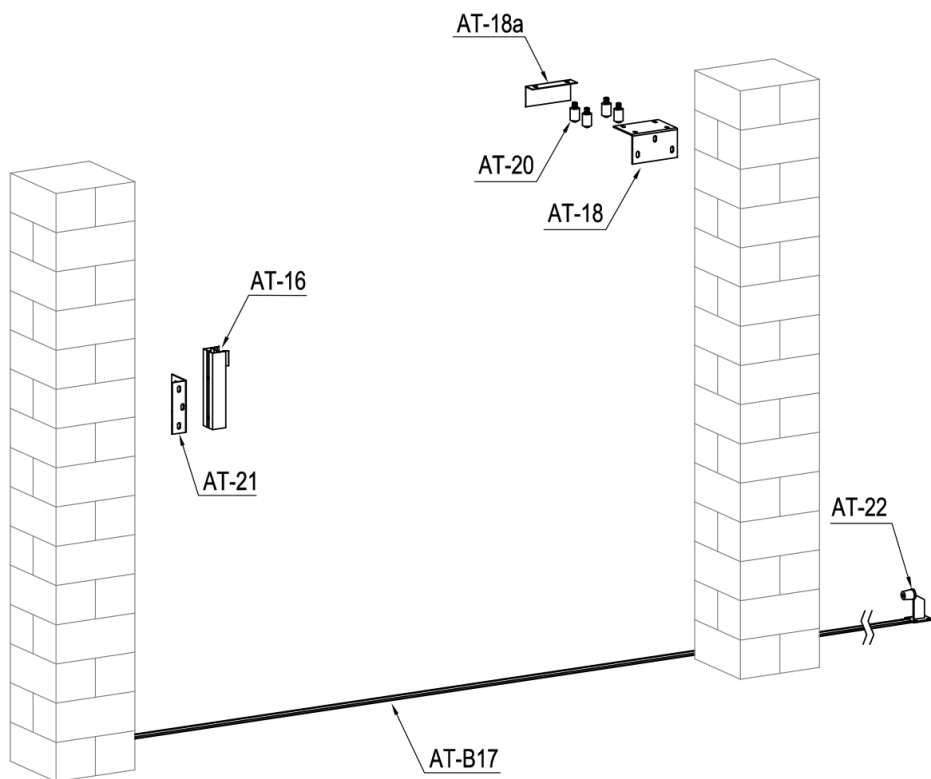















































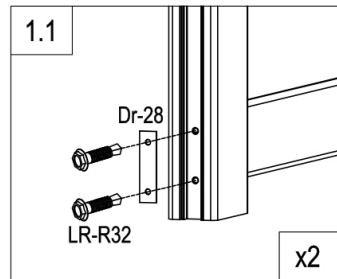
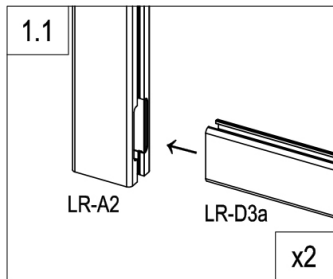
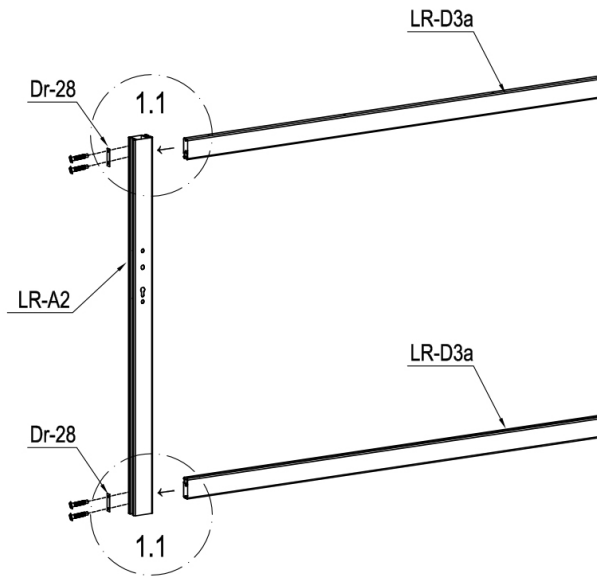



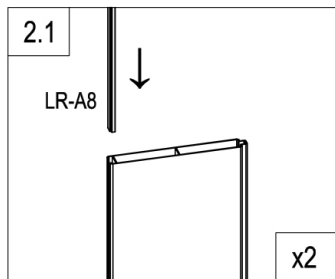
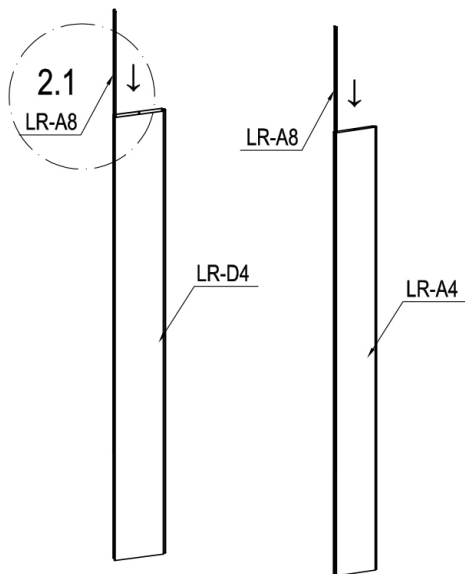





IMAGE	NO.	L.(mm)	QTY	IMAGE	NO.	L.(mm)	QTY
	LR-A1b	1418	2		Dr-14		1
	LR-A1c	1418	1		DO-30		4
	LR-A2	1418	1		AT-18	150	1
	AT-30	250	1		AT-18a	150	1
	AT-30a	250	1		ATW-14	420	1
	LR-D3a	1742	4		AT-19		4
	LR-D4	1245	16		AT-20		4
	LR-A4	1245	4		AT-21		1
	LR-D4a	1245	2		AT-22		1
	CK-A5b	1418	1		AT-23		2
	CK-B5	1293	1		Dr-18		1
	AT-A5a	395.5	1		Dr-19		1
	SR-A5a	782	1		Dr-20a		1
	AT-29	193	2		Dr-21		1
	CK-A11	1418	4		Dr-22		1
	AT-A11a	250	2		Dr-25		1
	LR-D11	1742	4		Dr-25a		2
	AT-31	250	2		Dr-27		2
	LR-D6	25	8		Dr-28		6
	LR-A8	1245	4		AT-22J		7
	CK-A7a	1365	1		LR-R30		4
	LR-D14	1608	2		LR-R31		10
	LR-D14a	1608	2		LR-R32		32
	LR-D16	1607	2		LR-R33		4
	AT-16		1		LR-R34		12
	AT-B17	1412	5		LR-R35		50
	AT-17		2		LR-R36		2
	AT-17a		2		LR-R37		8
	AT-10		4		LR-R38		50
	Dr-13		1				

# CASANOVA





	LR-A2	1
	LR-D3a	2
	Dr-28	2
	LR-R32	4



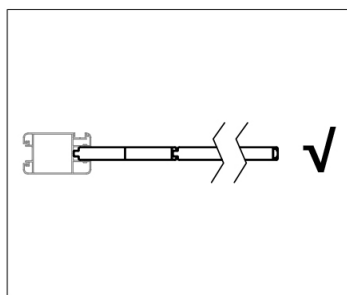
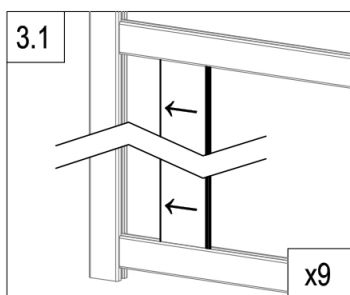
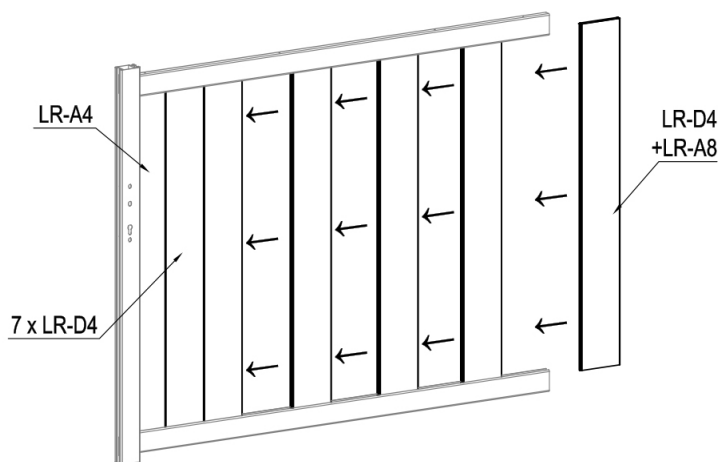

	LR-A8	2
	LR-D4	1
	LR-A4	1





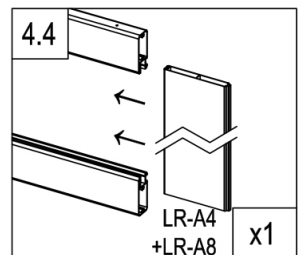
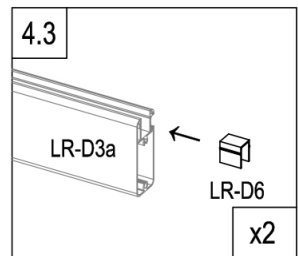
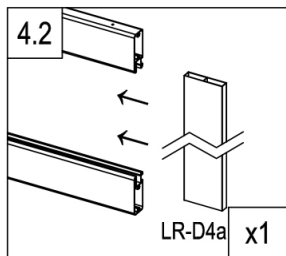
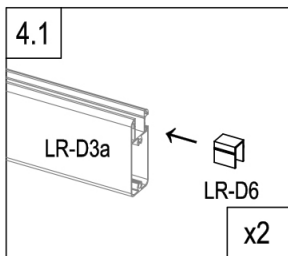
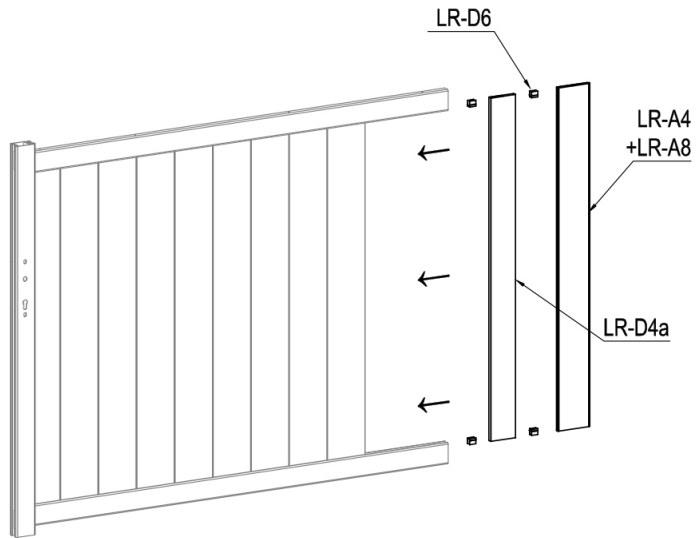



	LR-D4	7
	LR-A4	1

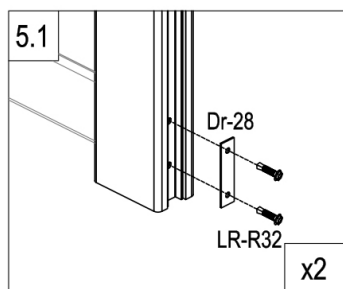
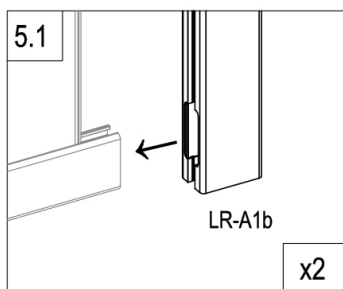
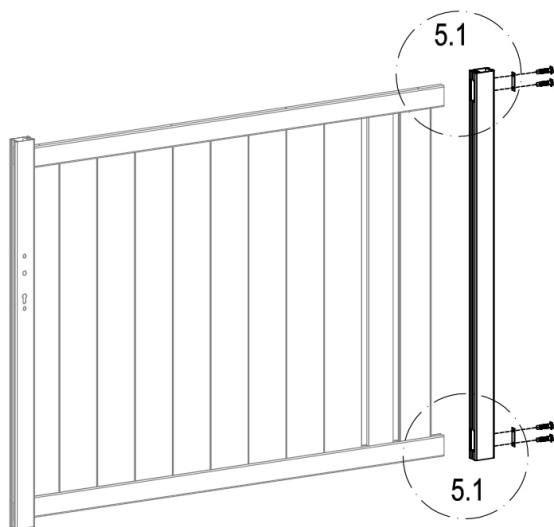



	LR-D4a	1
	LR-D6	4

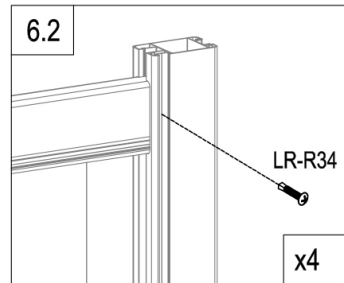
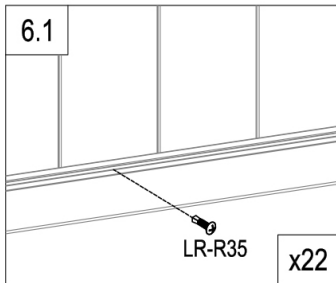
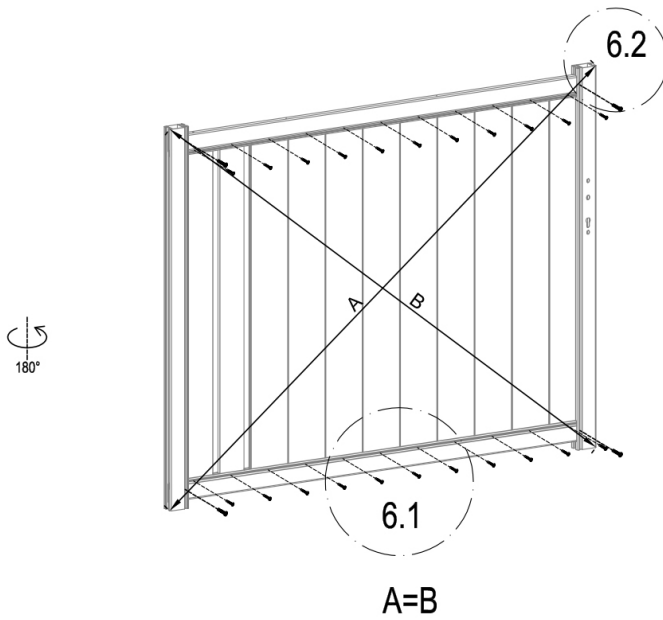

	LR-A1b	1
	Dr-28	2
	LR-R32	4



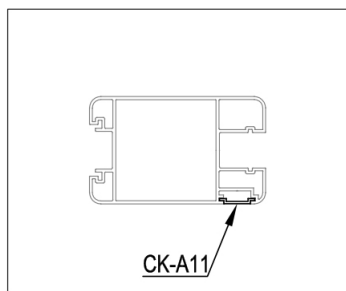
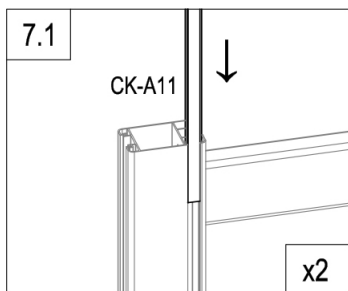
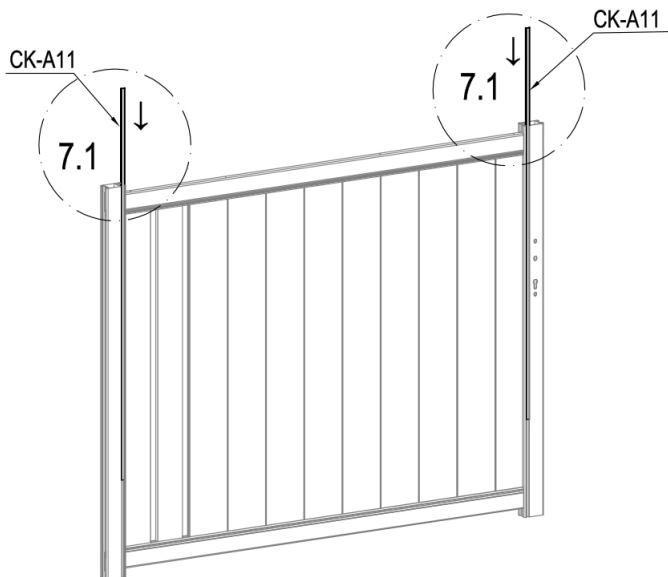

	LR-R35	22
	LR-R34	4

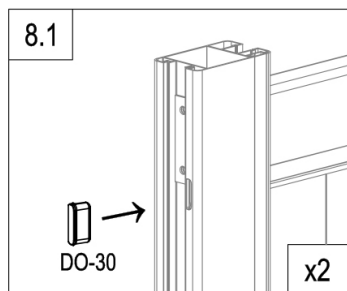
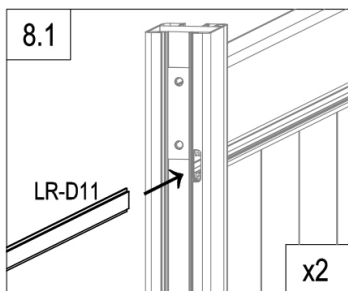
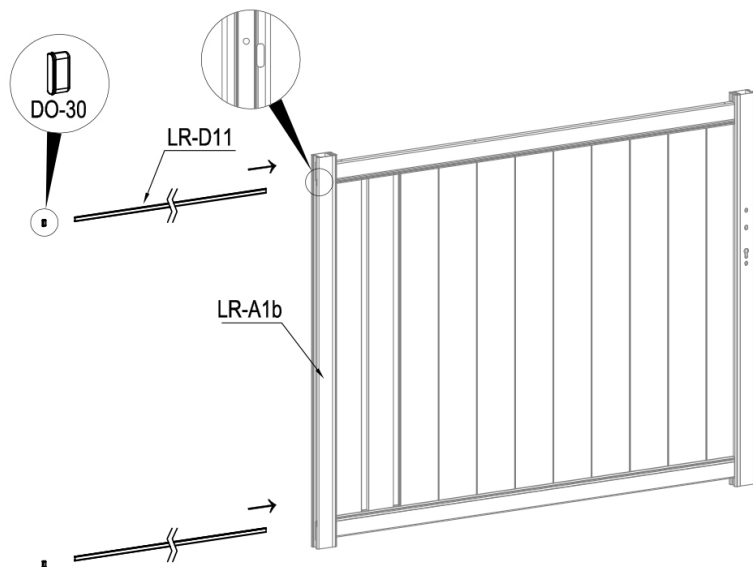

	CK-A11	2
---	--------	---



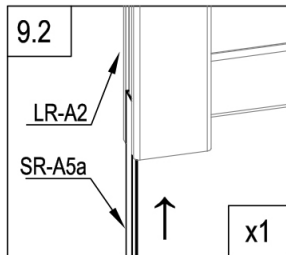
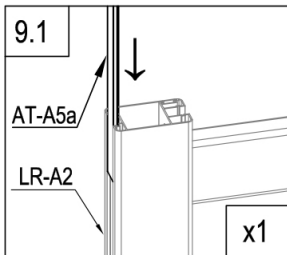
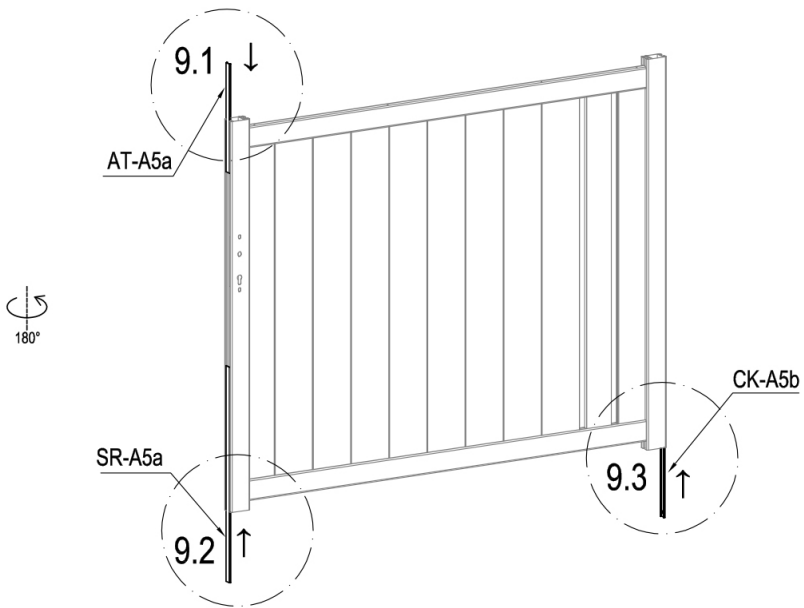

	LR-D11	2
	DO-30	2

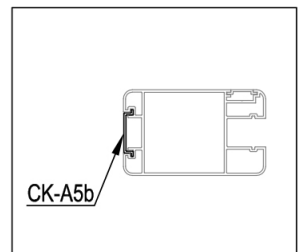

	CK-A5b	1
	AT-A5a	1
	SR-A5a	1

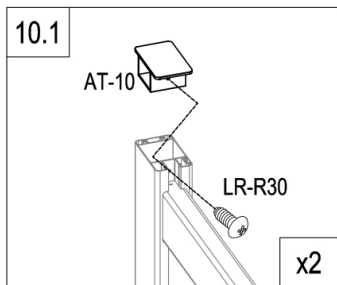
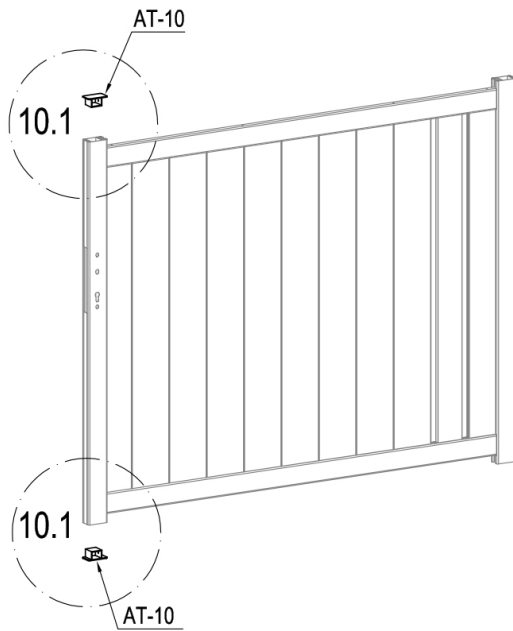







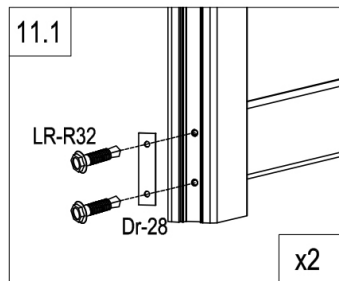
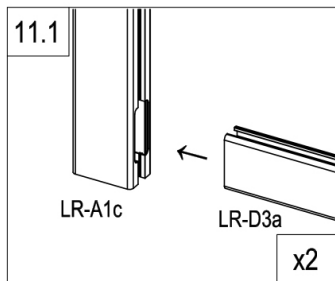
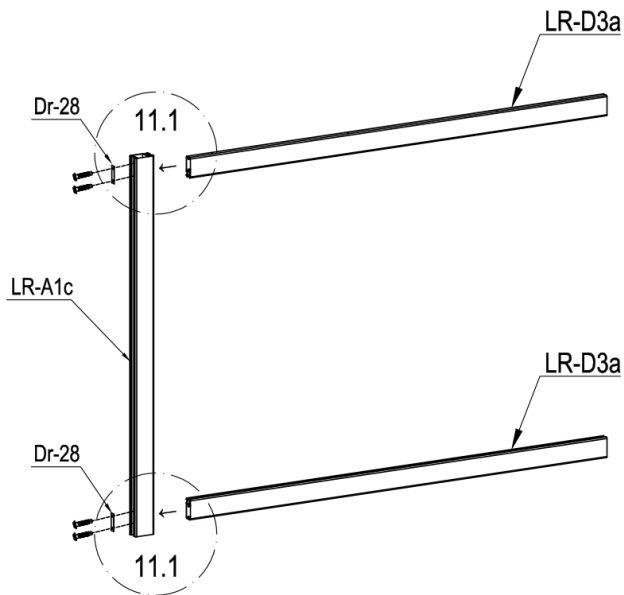



	AT-10	2
	LR-R30	2



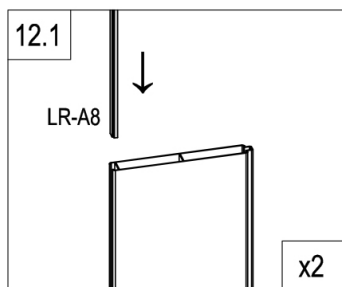
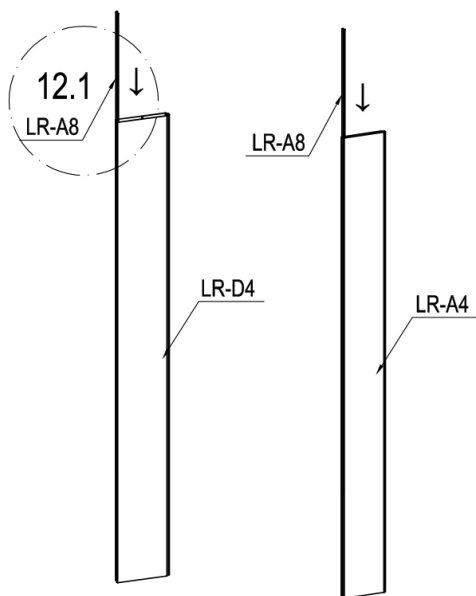



	LR-A1c	1
	LR-D3a	2
	Dr-28	2
	LR-R32	4

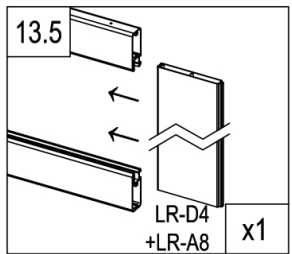
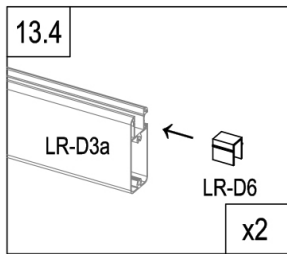
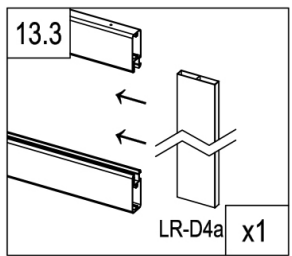
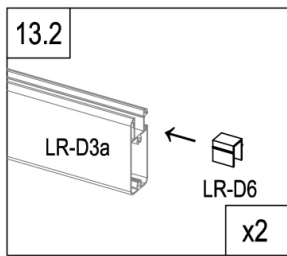
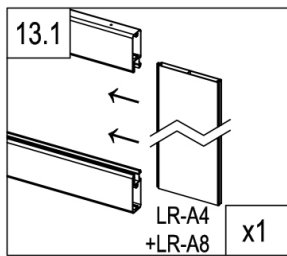
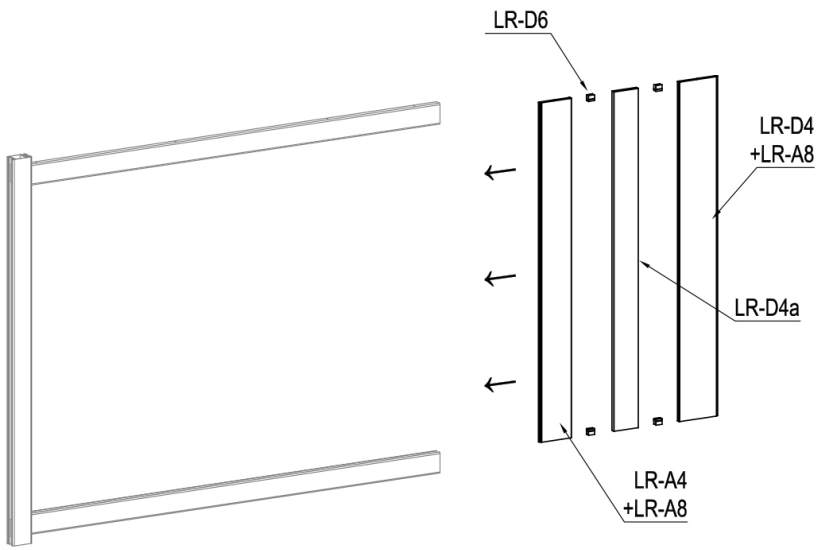

	LR-A8	2
	LR-D4	1
	LR-A4	1



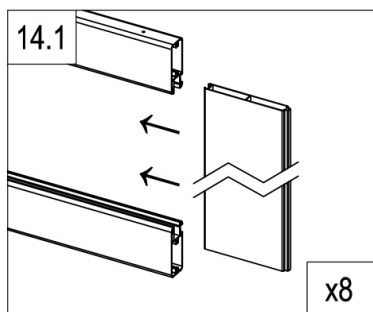
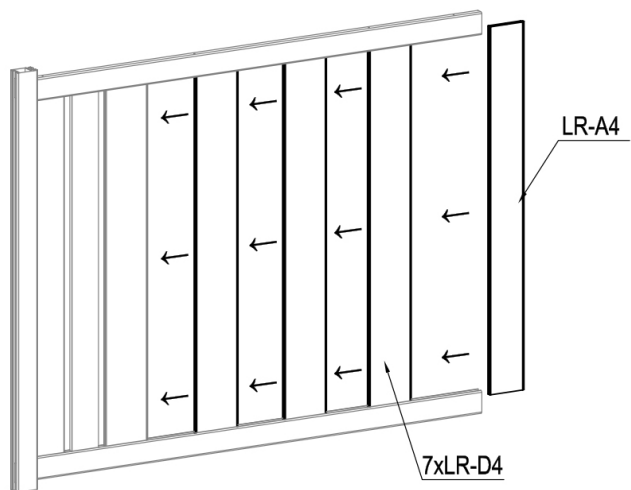

	LR-D4a	1
	LR-D6	4

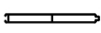
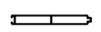

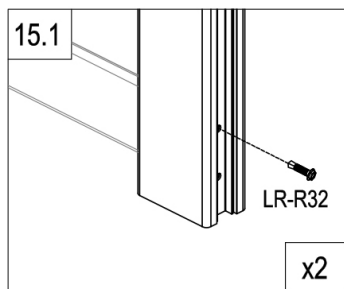
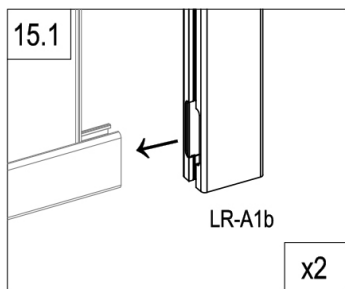
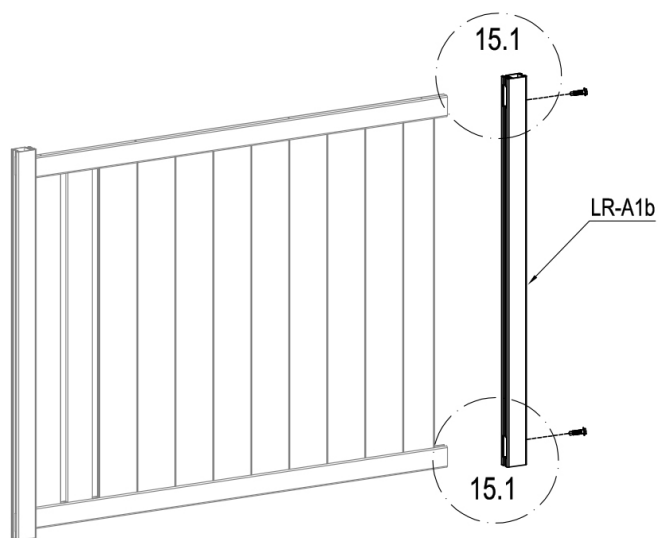

	LR-D4	7
	LR-A4	1

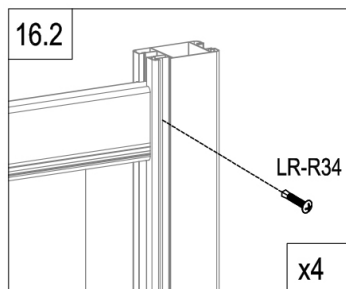
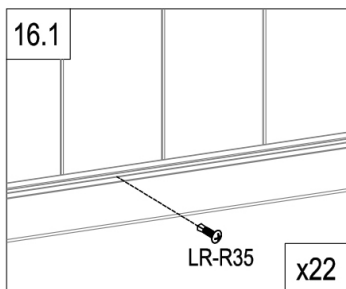
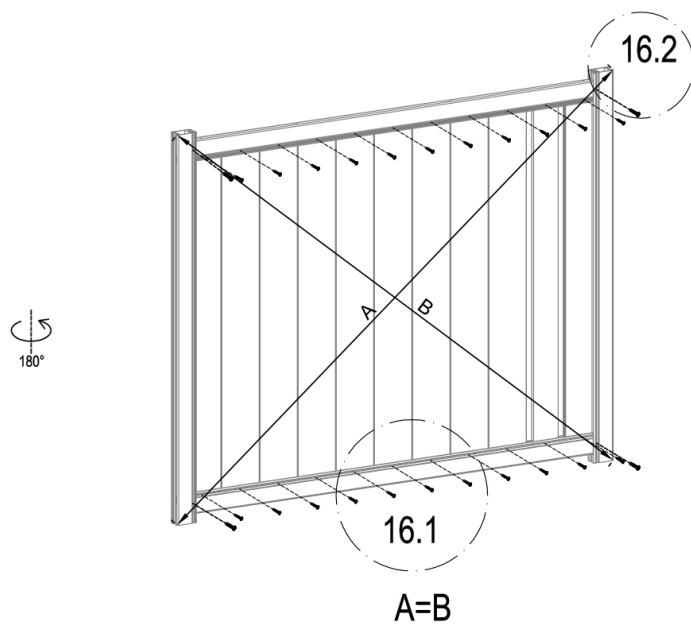

	LR-A1b	1
	LR-R32	2



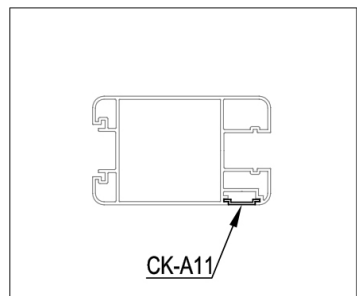
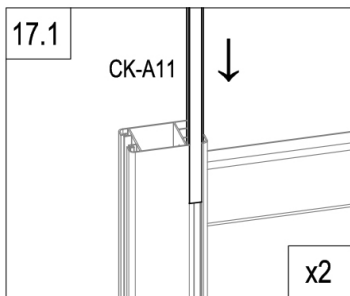
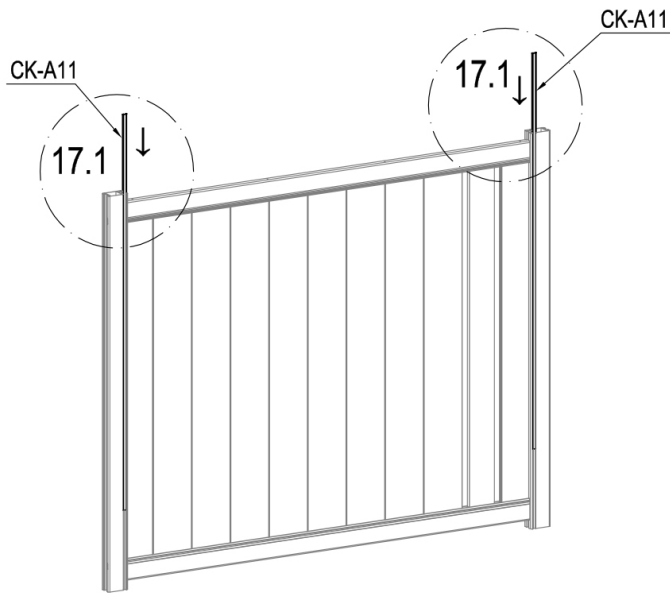

	LR-R35	22
	LR-R34	4

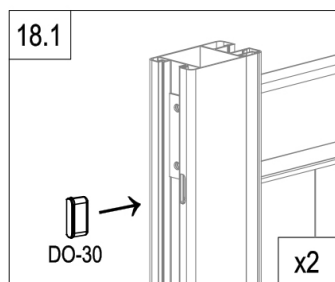
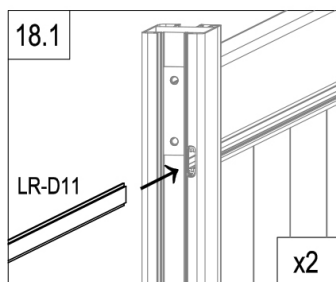
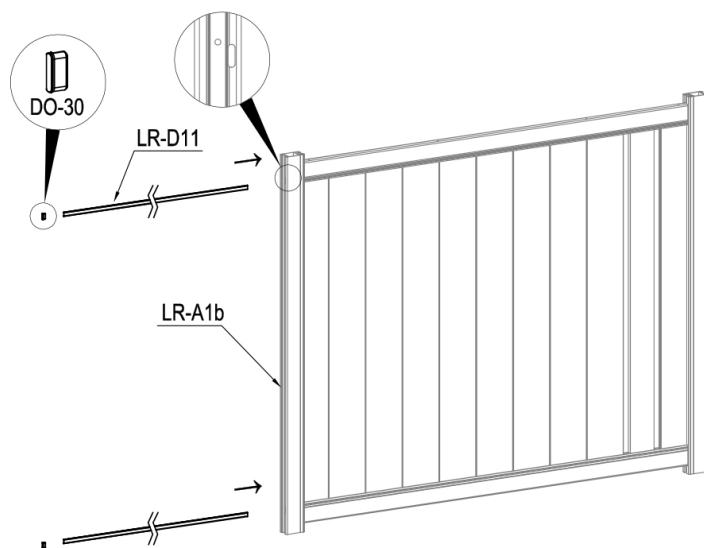

	CK-A11	2
---	--------	---



	LR-D11	2
	DO-30	2



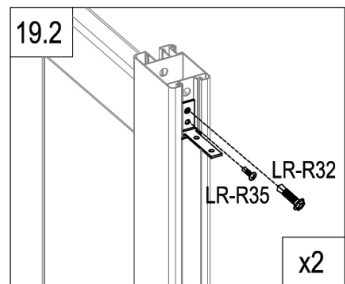
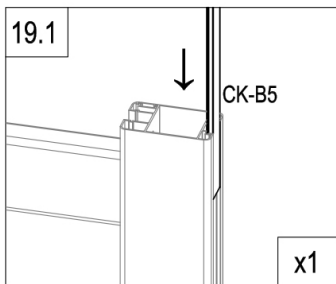
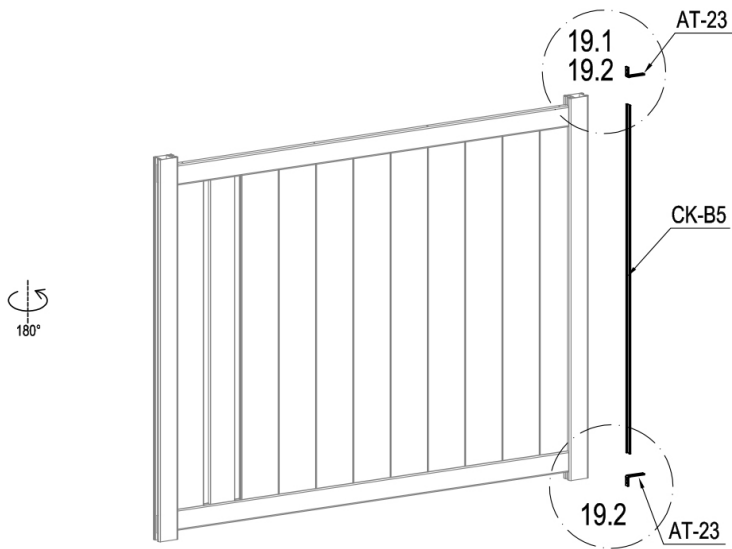

	CK-B5	1
	AT-23	2
	LR-R32	2
	LR-R35	2

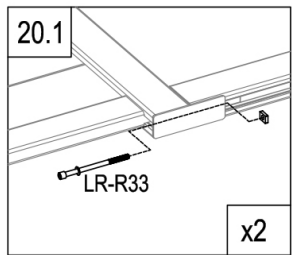
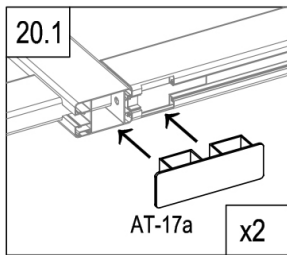
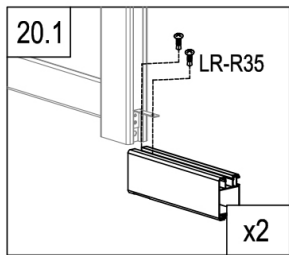
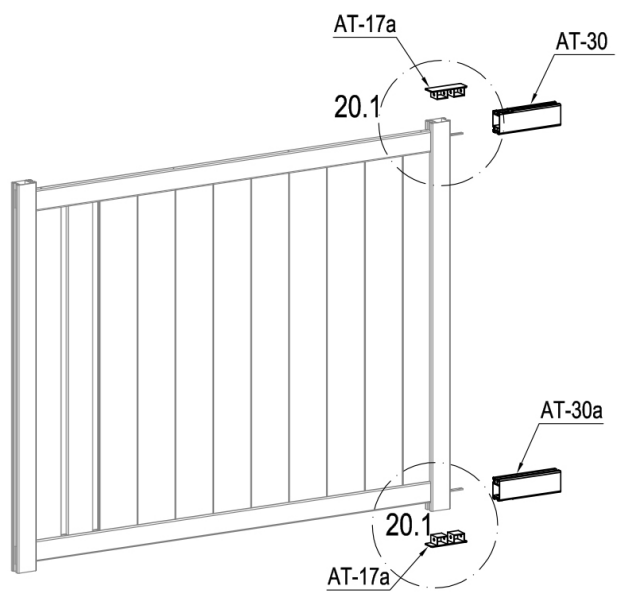



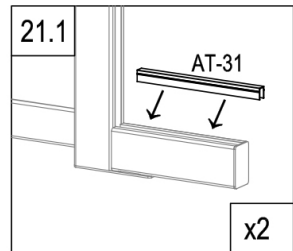
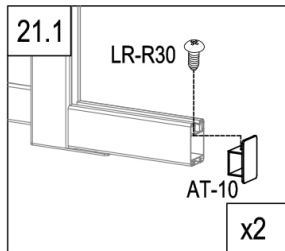
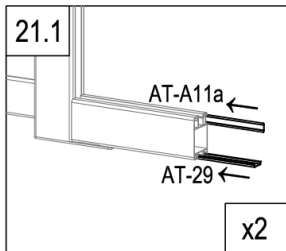
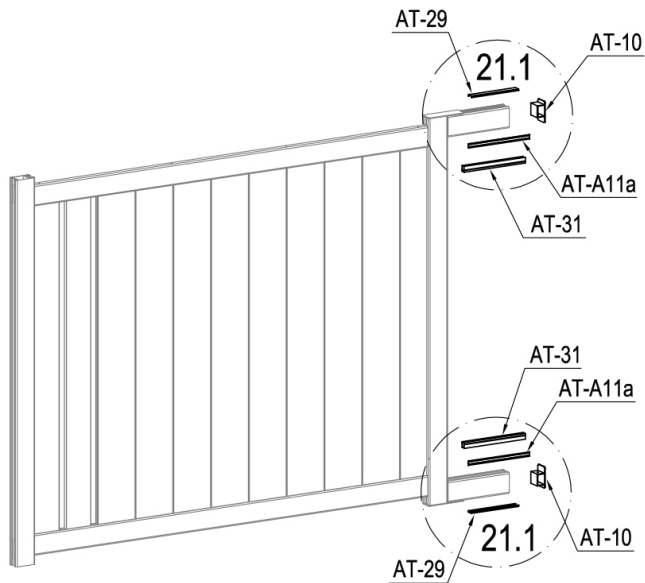

	AT-30	1
	AT-30a	1
	AT-17a	2

	LR-R33	2
	LR-R35	4



# CASANOVO



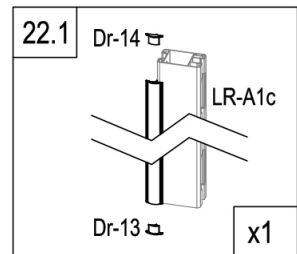
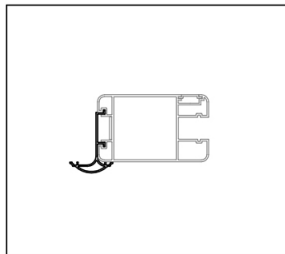
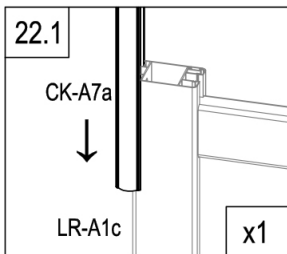
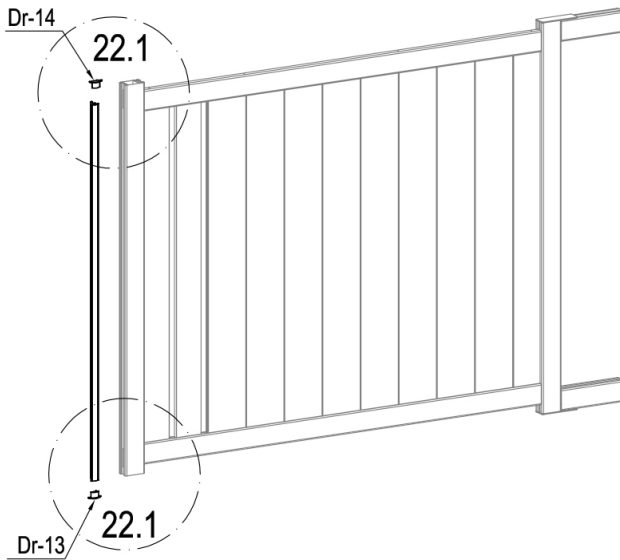

	AT-29	2
	AT-A11a	2
	AT-31	2

	AT-10	2
	LR-R30	2



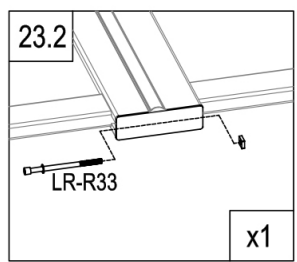
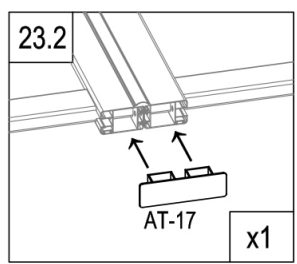
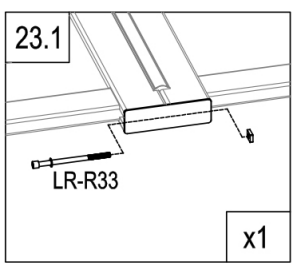
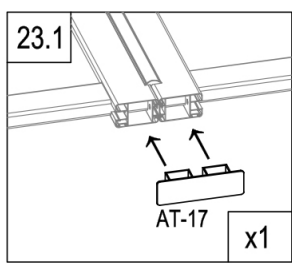
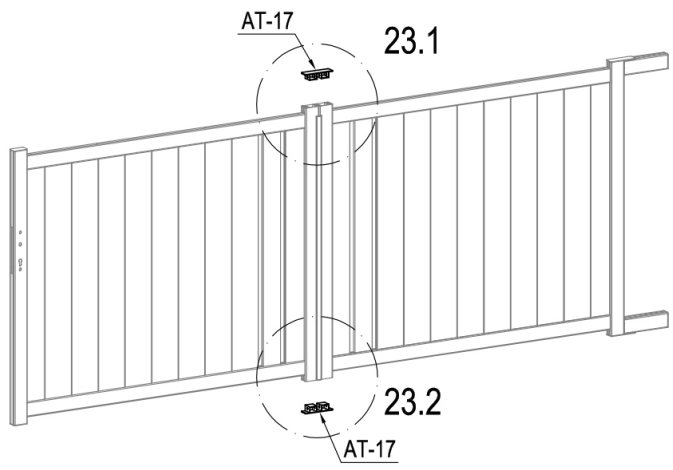

	CK-A7a	1
	Dr-13	1
	Dr-14	1



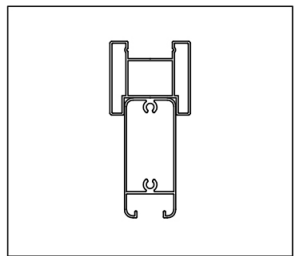
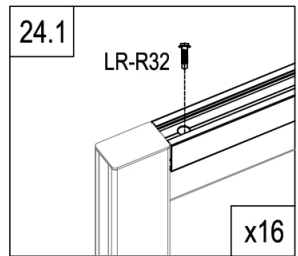
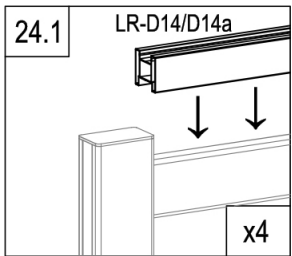
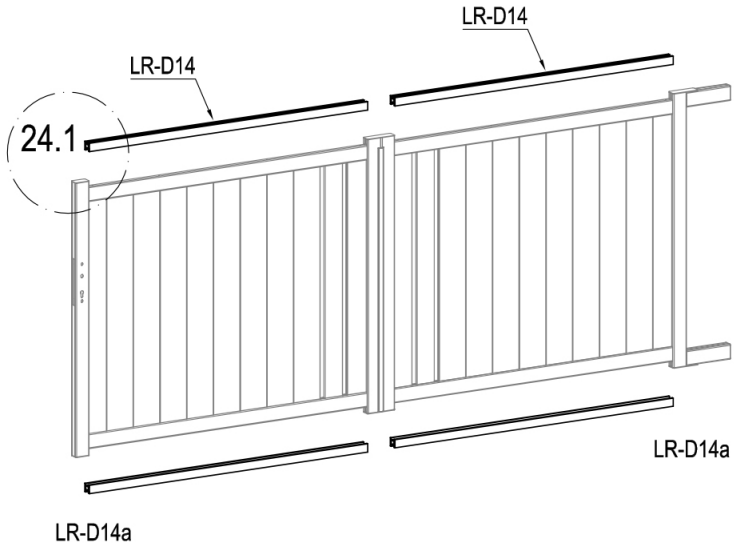

	AT-17	2
	LR-R33	2



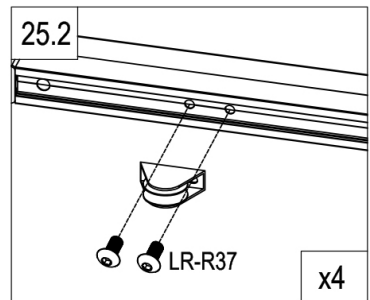
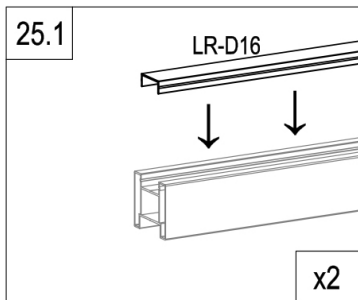
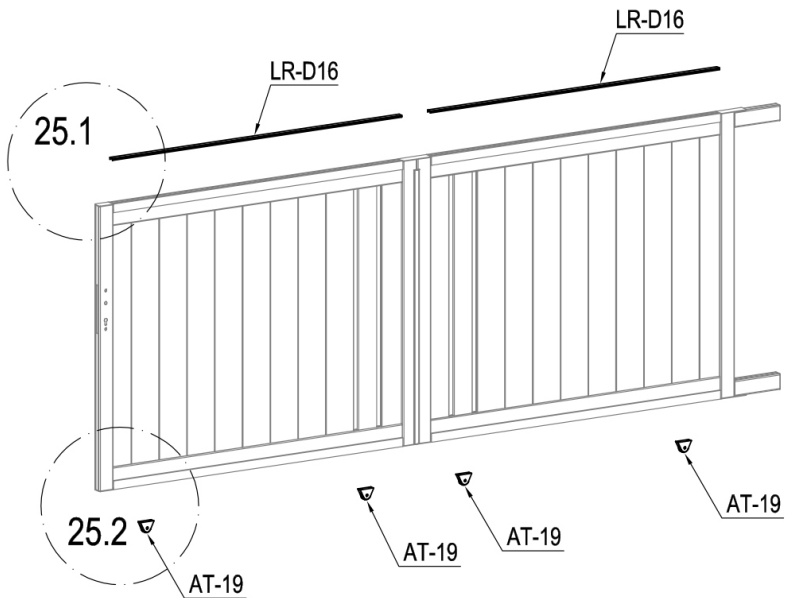

	LR-D14	2
	LR-D14a	2
	LR-R32	16

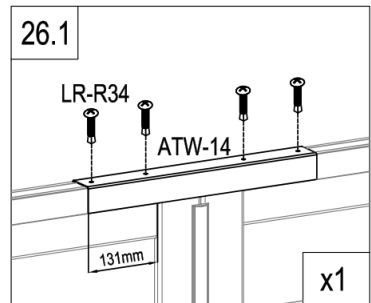
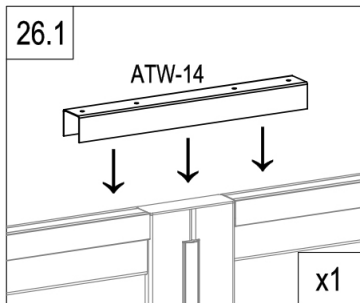
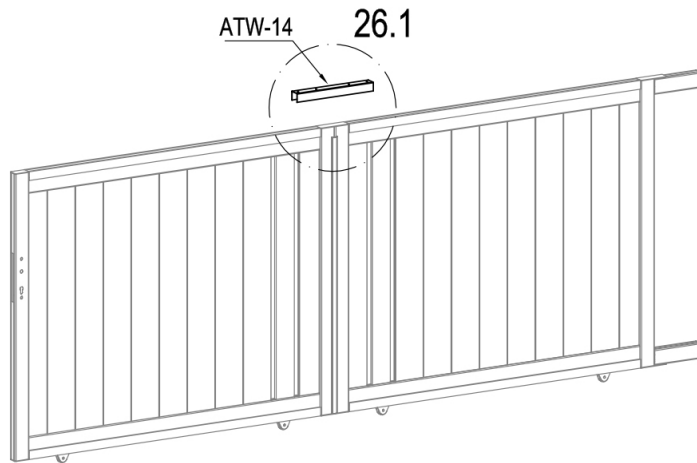

	LR-D16	2
	AT-19	4
	LR-R37	8



	ATW-14	1
	LR-R34	4



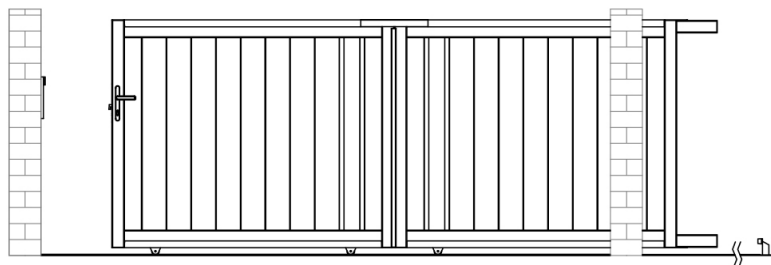

**L** : P27~32

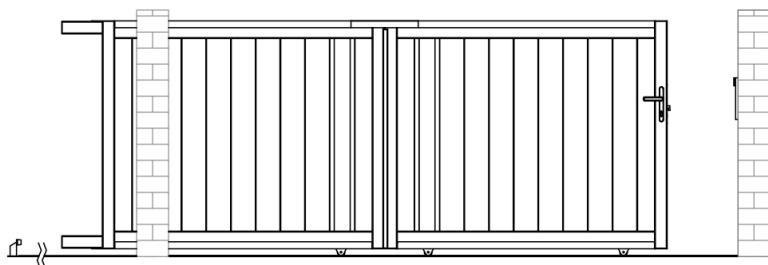

**R** : P33~38

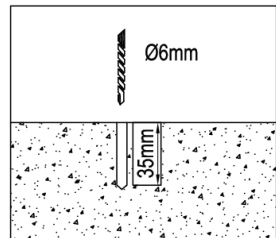
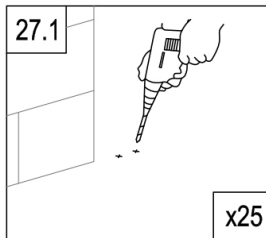
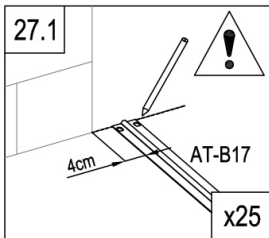
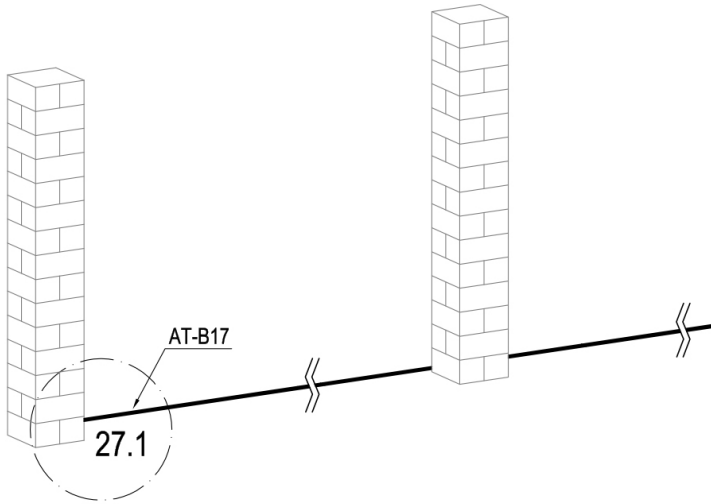

	AT-B17	5
	LR-R38	50

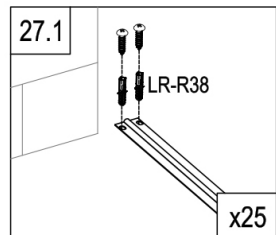

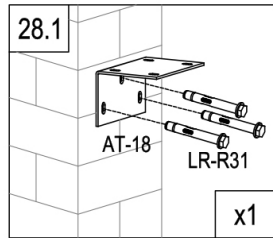
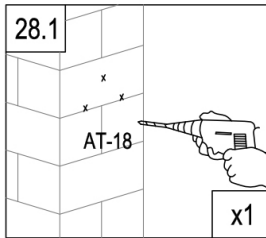
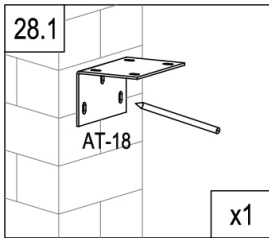
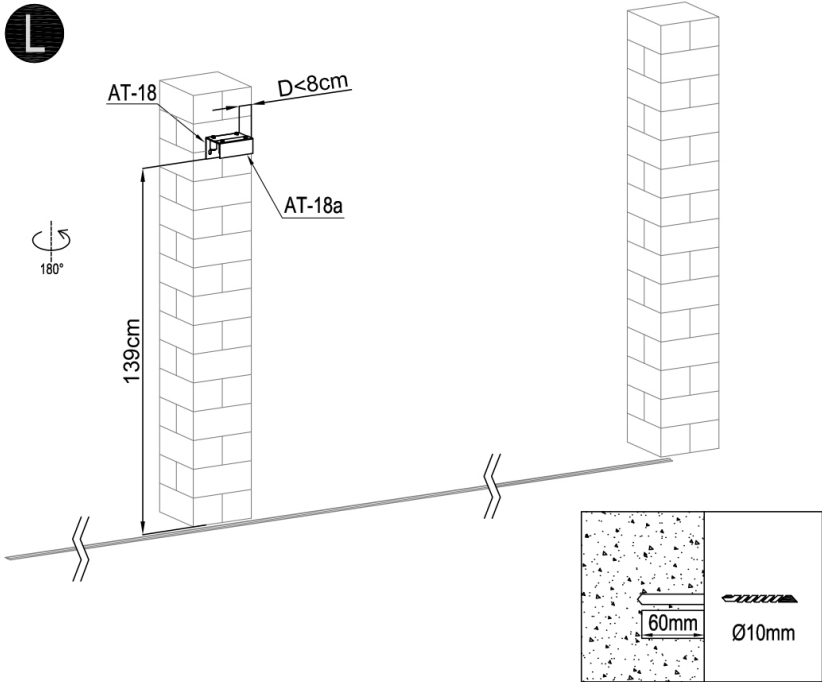

	AT-18	1
	AT-18a	1
	AT-20	4
	LR-R31	3

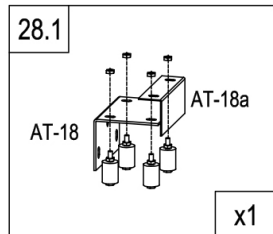
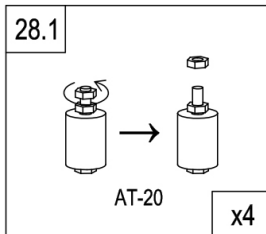

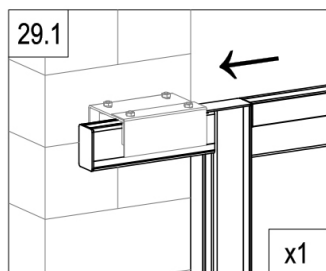
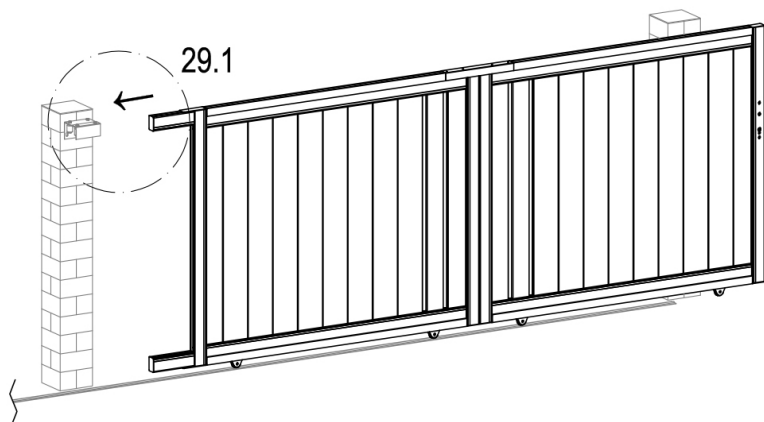

L

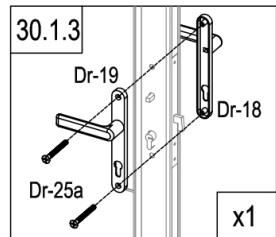
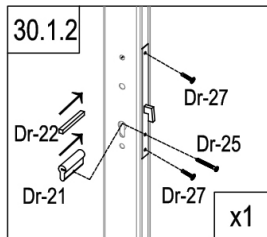
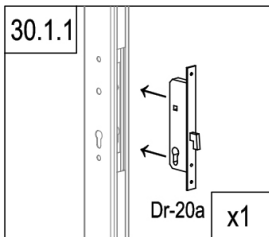
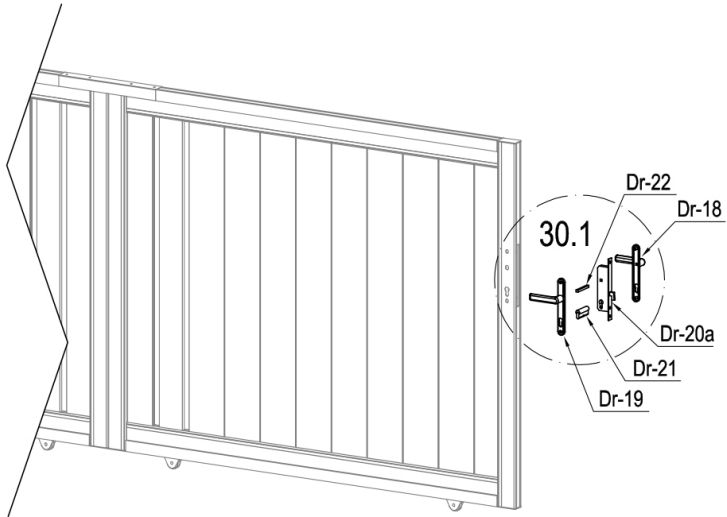

	Dr-20a	1
	Dr-21	1
	Dr-22	1
	Dr-25	1

	Dr-18	1
	Dr-19	1
	Dr-25a	2
	Dr-27	2

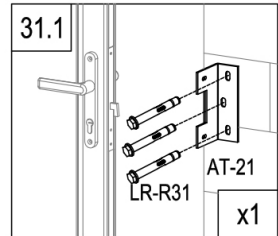
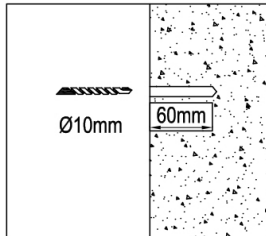
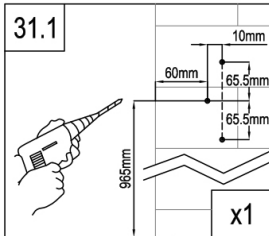
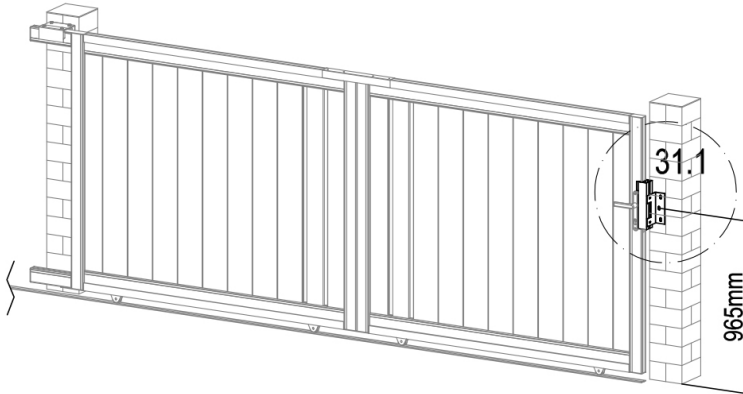

	AT-16	1
	AT-21	1
	LR-R36	2
	LR-R31	3
	AT-22J	3

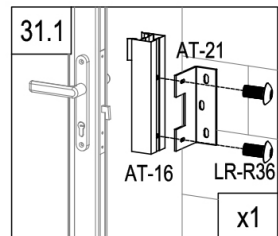
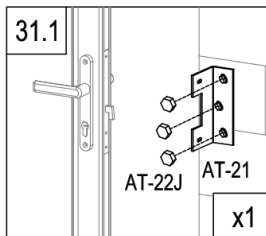

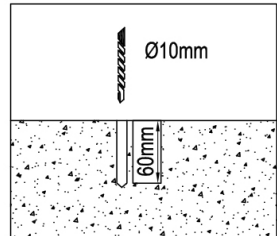
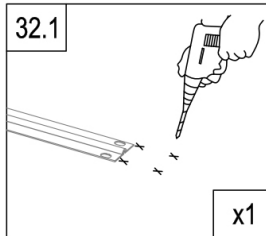
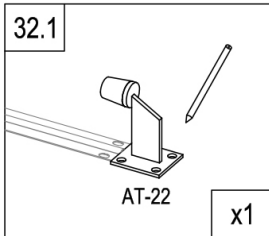
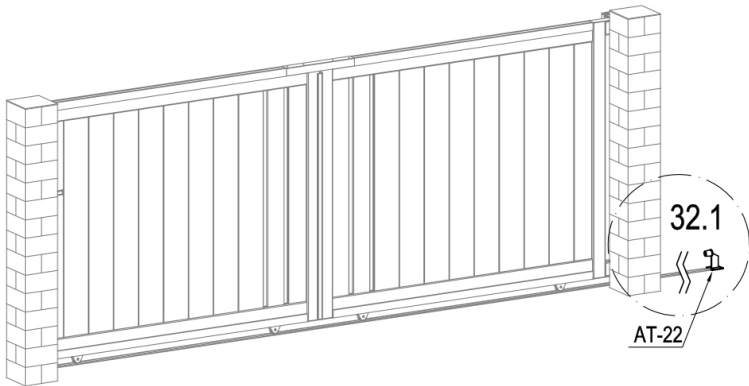

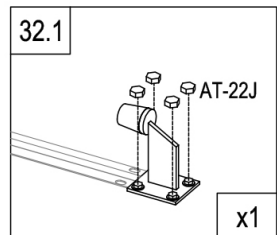
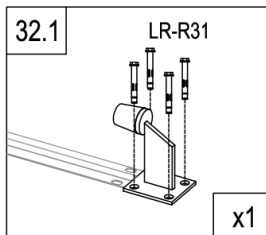

	AT-22	1
	LR-R31	4
	AT-22J	4

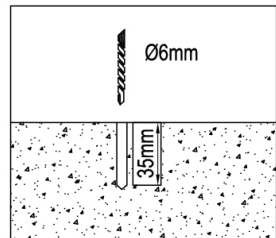
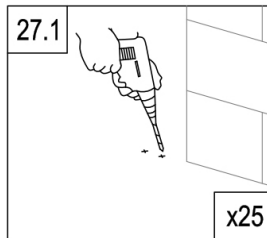
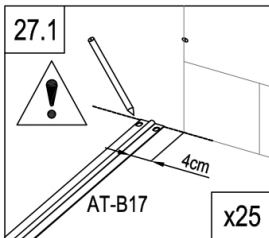
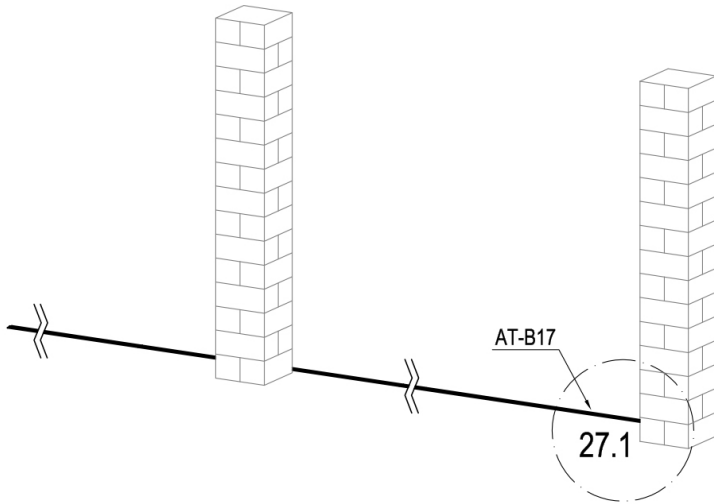

R



	AT-B17	5
	LR-R38	50

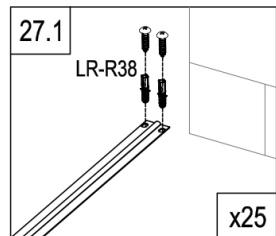



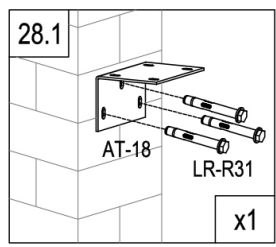
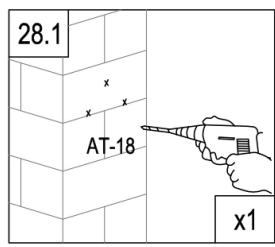
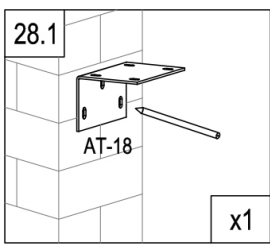
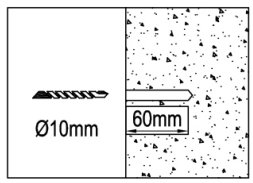
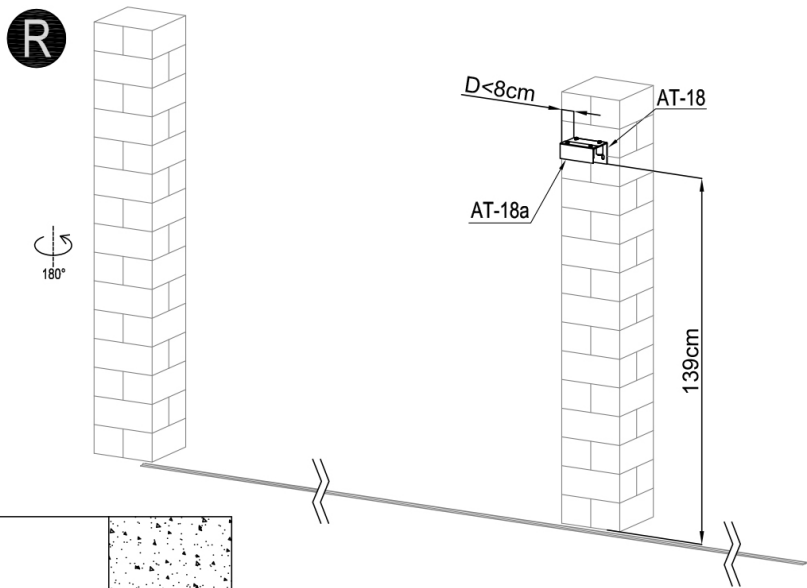

	AT-18	1
	AT-18a	1
	AT-20	4
	LR-R31	3

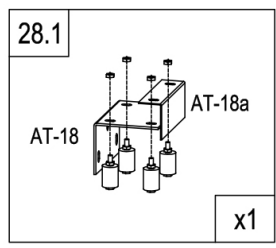
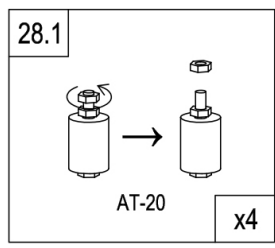

R

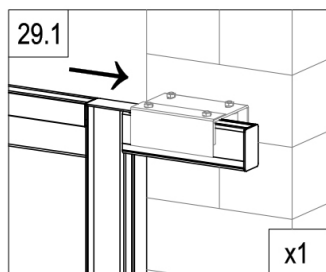
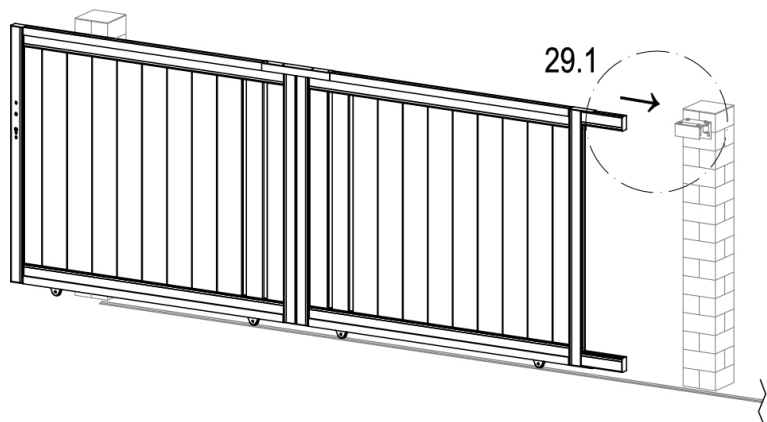

R

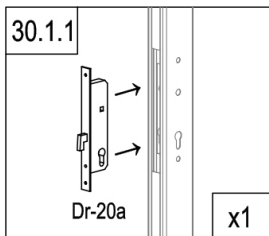
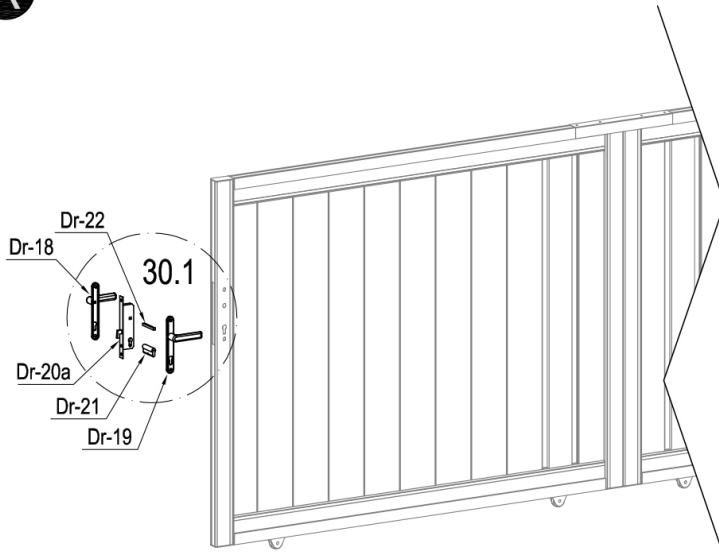

	Dr-20a	1
	Dr-21	1
	Dr-22	1
	Dr-25	1

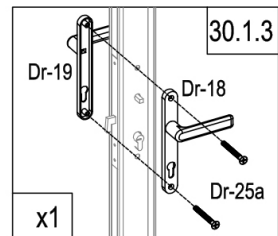
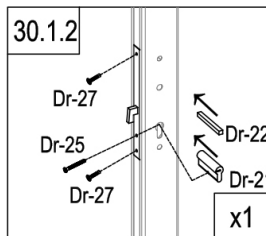

	Dr-18	1
	Dr-19	1
	Dr-25a	2
	Dr-27	2

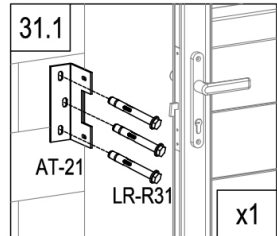
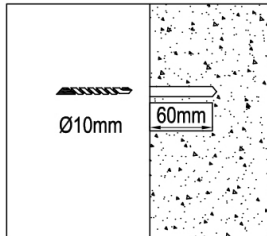
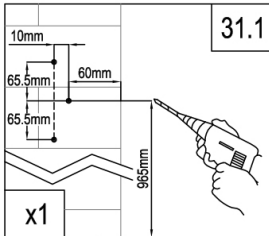
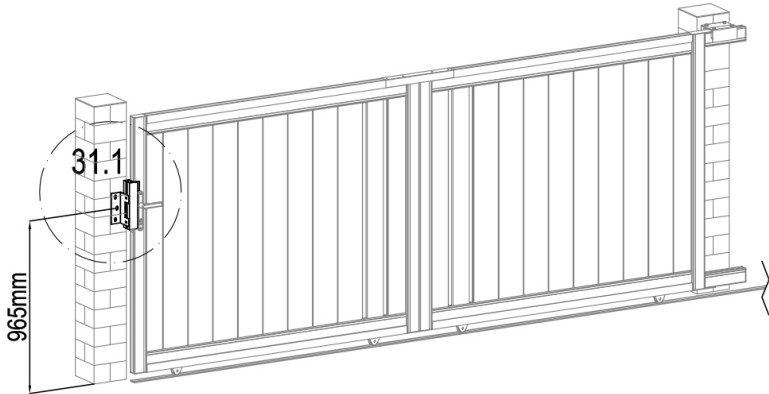

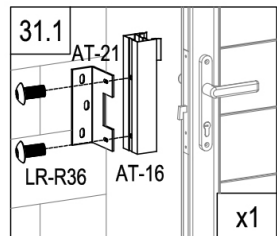
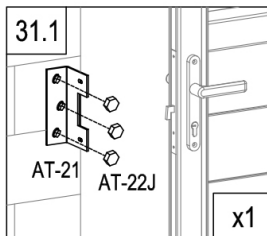

	AT-16	1
	AT-21	1
	LR-R36	2
	LR-R31	3
	AT-22J	3

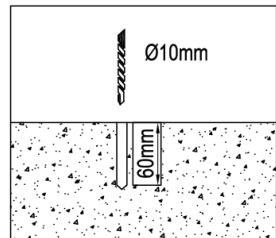
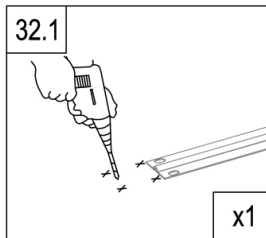
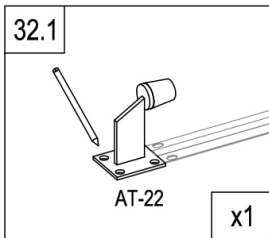
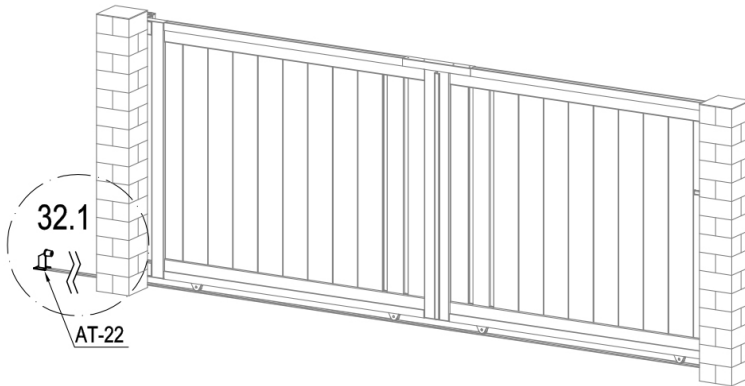

R



	AT-22	1
	LR-R31	4
	AT-22J	4

