

CASANOVO

VEYMONT 400B160

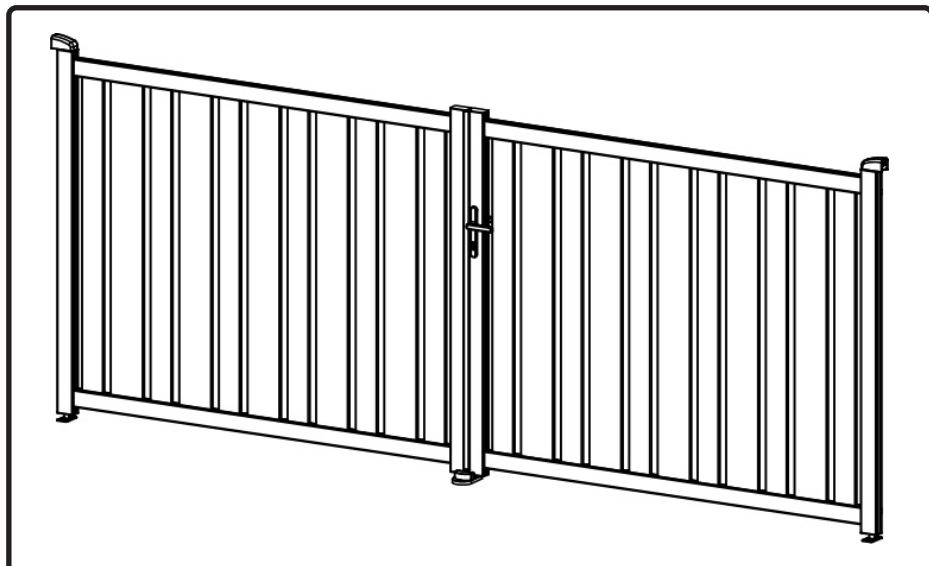

COM-000836 [x1]

COM-000838 [x1]

COM-000837 [x1]



EN FR DE ES PT IT NL PL FI SE DK
RO SI SK HU CZ HR GR LT LV



INSTRUCTION MANUAL / NOTICE DE MONTAGE / MONTAGEANLEITUNG / MANUAL DE MONTAJE / MANUAL DE MONTAGEM / MANUALE DI MONTAGGIO /
MONTAGEHANDLEIDING / INSTRUKCJA MONTAŻU / KÄYTTÖOHJEET / BRUKSANVISNING / BRUGSANVISNING / INSTRUCȚIUNI DE ASAMBLARE /
NAVODILA ZA SESTAVLJANJE / NÁVOD NA MONTÁŽ / ÖSSZESZERELÉSI ÚTMUTATÓ / NÁVOD K MONTÁŽI / UPUTE ZA INSTALACIJU /
ΟΔΗΓΙΕΣ ΣΥΝΑΡΜΟΛΟΓΗΣΗΣ / SURINKIMO INSTRUKCIJOS / MONTŽAS INSTRUKCIJAS

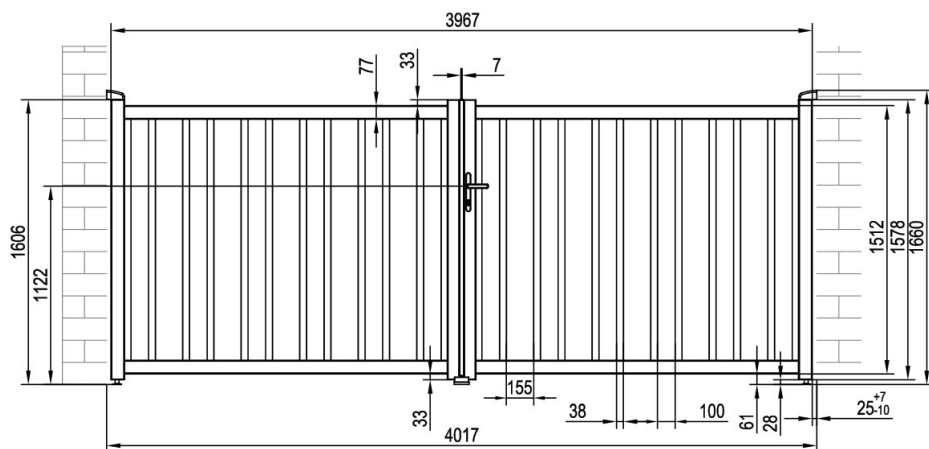

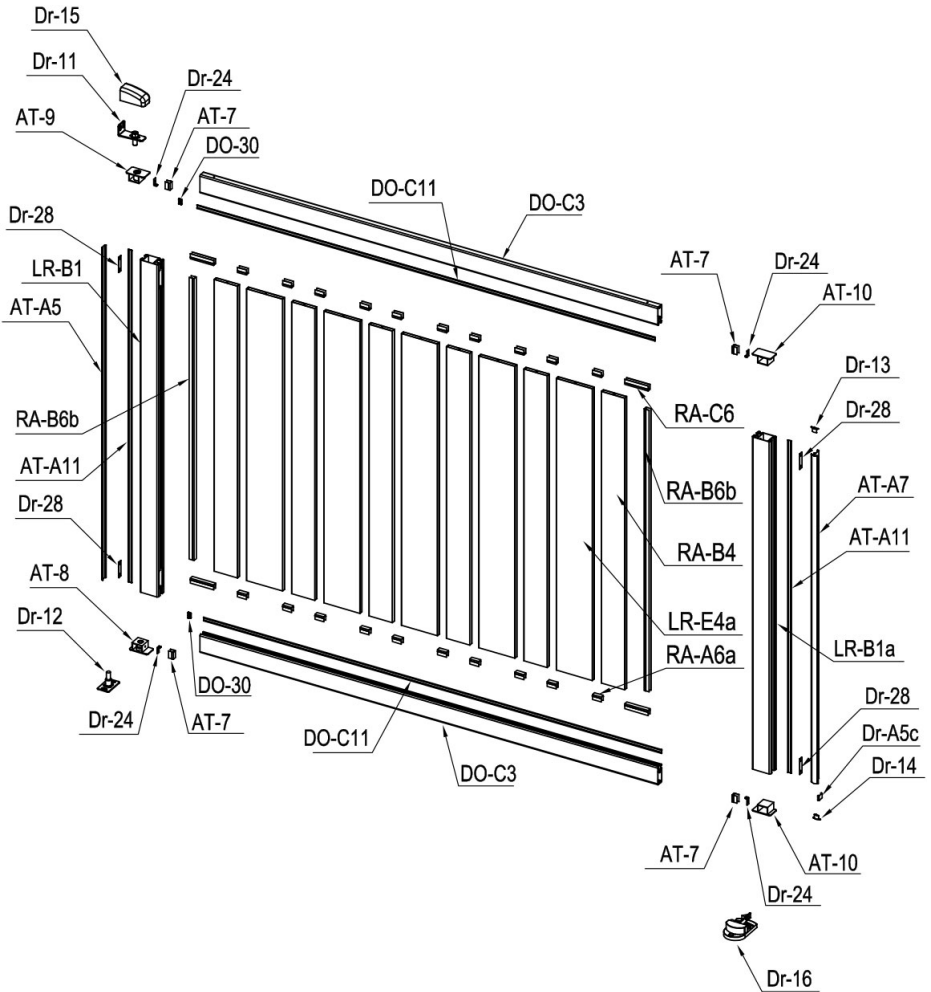



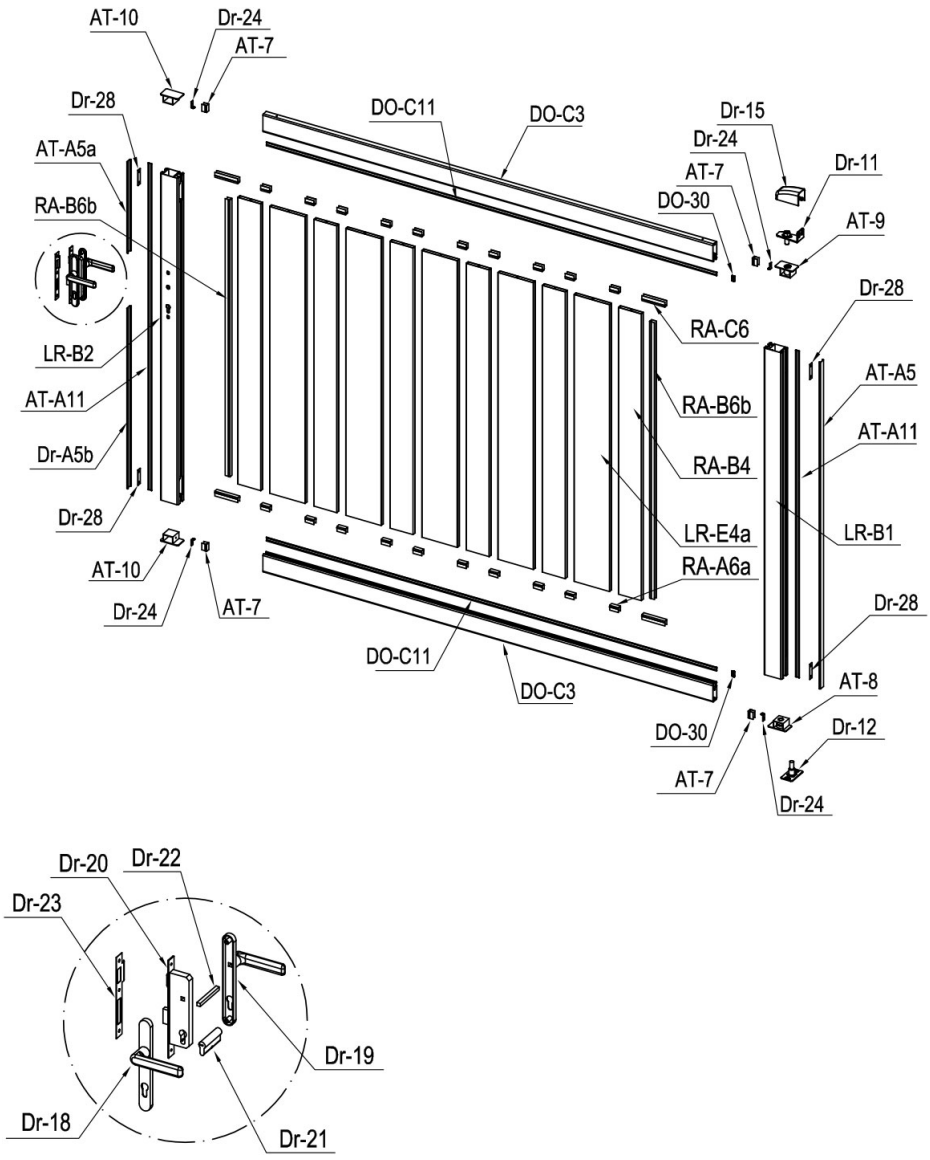







































CASANOVO



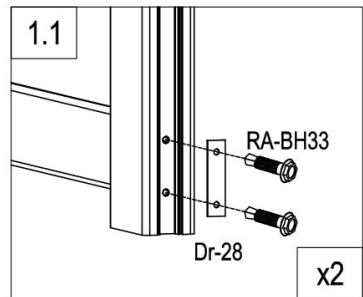
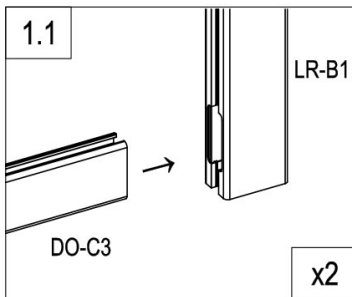
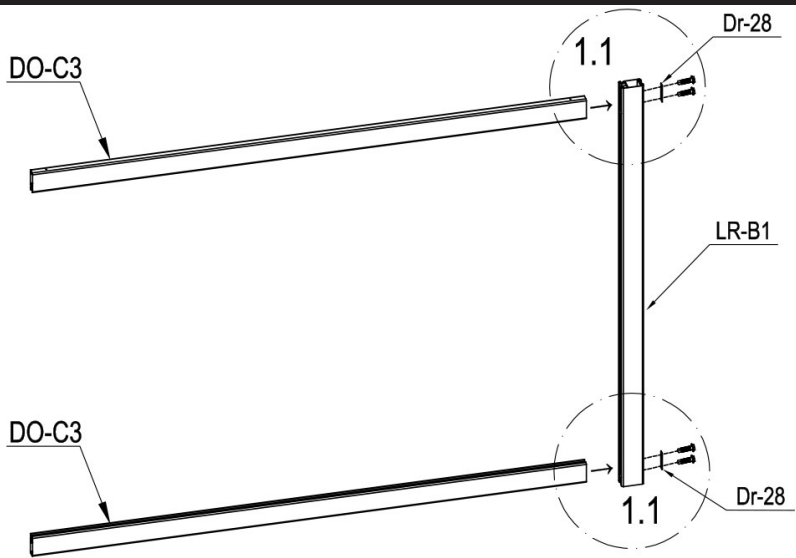

PART LIST

IMAGE	NO.	L.(mm)	QTY	IMAGE	NO.	L.(mm)	QTY
	LR-B1	1573	2		Dr-16		1
	LR-B1a	1573	1		Dr-17		2
	LR-B2	1573	1		Dr-31		4
	DO-C3	1957	4		DO-30		4
	RA-B4	1400	10		Dr-18		1
	LR-E4a	1400	12		Dr-19		1
	AT-A5	1573	2		Dr-20		1
	AT-A5a	395.5	1		Dr-21		1
	Dr-A5b	937	1		Dr-22		1
	Dr-A5c	19.5	1		Dr-23		1
	AT-A11	1573	4		Dr-25	M5x45	1
	DO-C11	1957	4		Dr-25a	M5x60	2
	AT-7	29.5	8		Dr-26	ST4x12	3
	RA-A6a	38	40		Dr-27	ST4.2x25	2
	RA-B6b	1357	4		Dr-24		8
	RA-C6	100	8		Dr-28		8
	AT-A7	1553	1		RA-BH30	ST4x10	8
	AT-8		2		RA-BH31	ST4.2x13	72
	AT-9		2		RA-BH32	M8x60	12
	AT-10		4		RA-BH33	ST5.5x38	16
	Dr-11		2		RA-BH34	ST6x40	3
	Dr-12		2		RA-BH35	Ø6	3
	Dr-13		1		RA-BH36	ST4.8x38	8
	Dr-14		1				
	Dr-15		2				



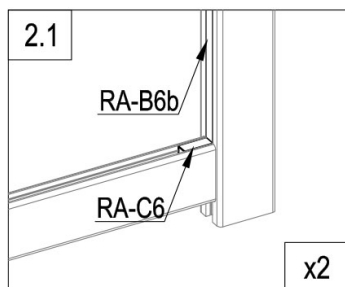
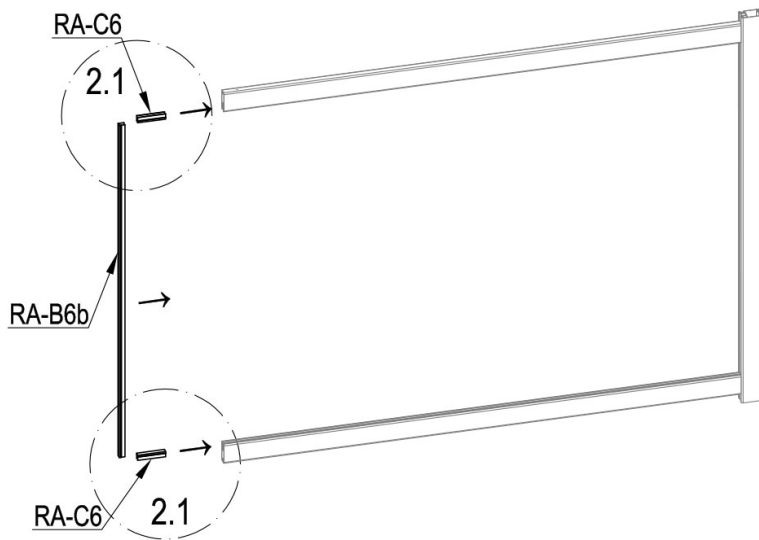

	LR-B1	1
	DO-C3	2
	Dr-28	2
	RA-BH33	4

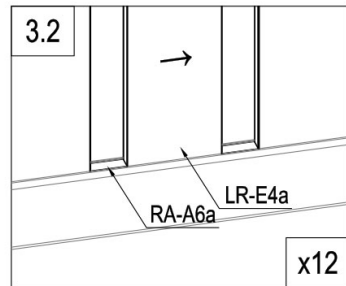
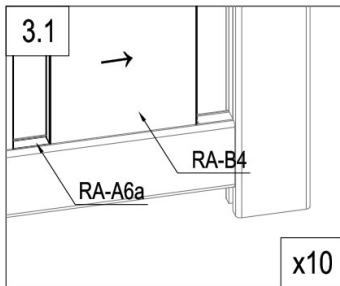
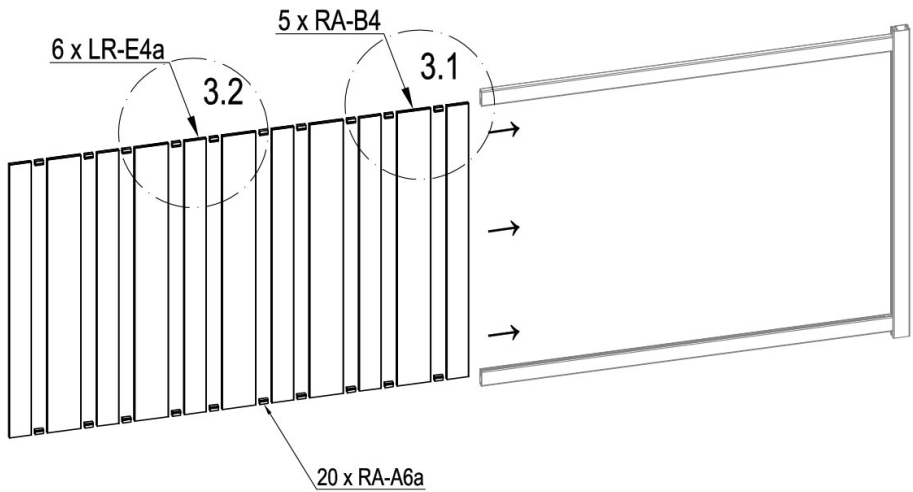

	RA-C6	2
	RA-B6b	1





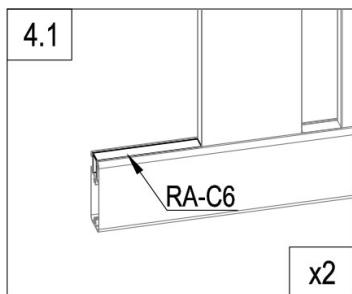
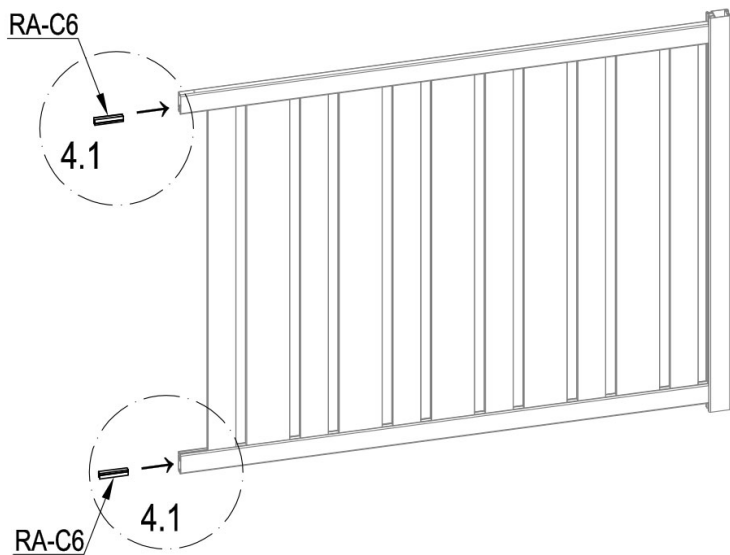

	RA-B4	5
	LR-E4a	6
	RA-A6a	20

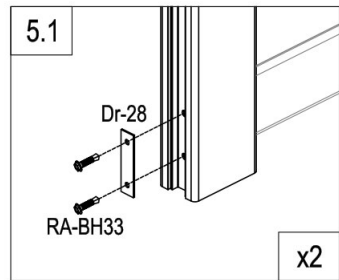
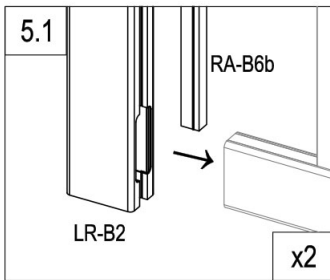
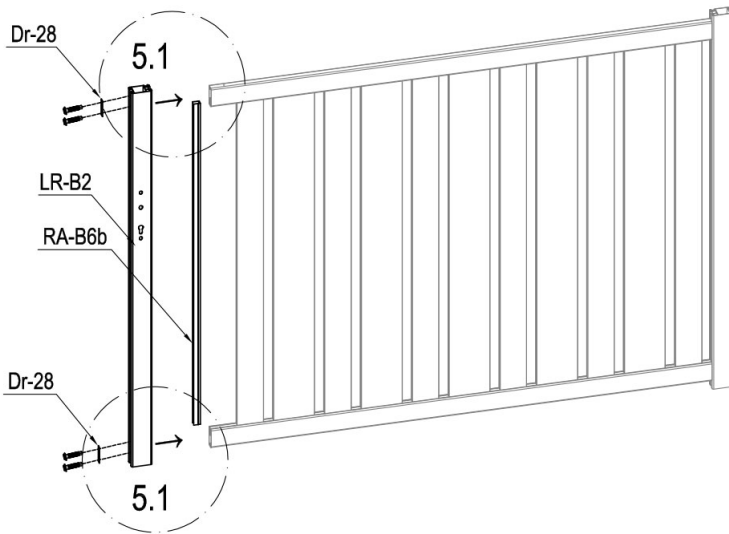

	RA-C6	2
---	-------	---



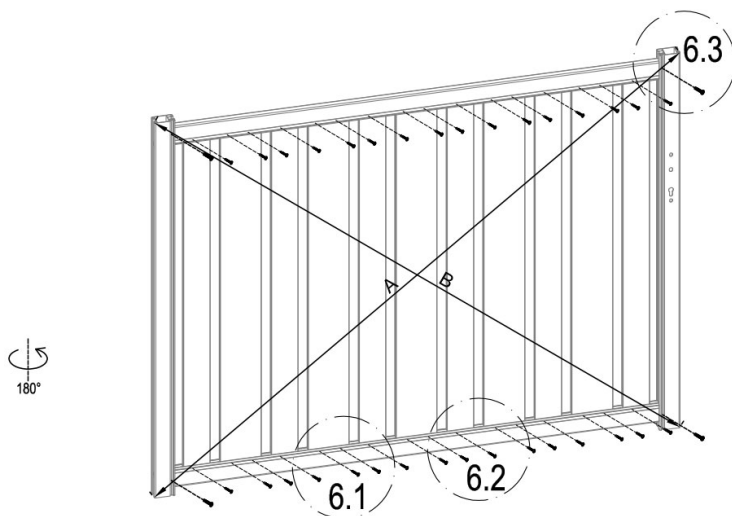

	LR-B2	1
	RA-B6b	1
	Dr-28	2
	RA-BH33	4

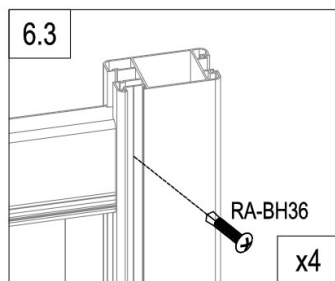
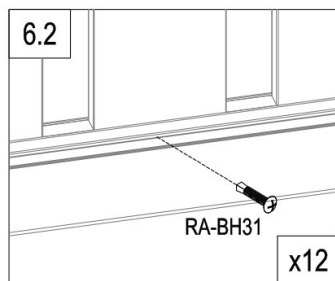
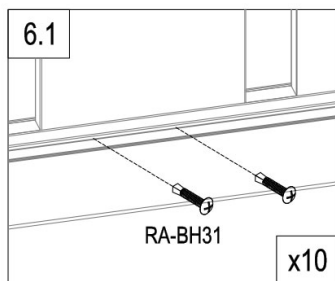

A=B



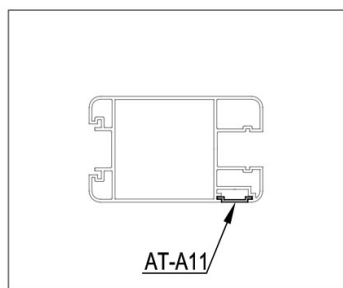
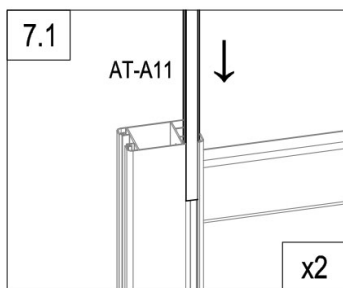
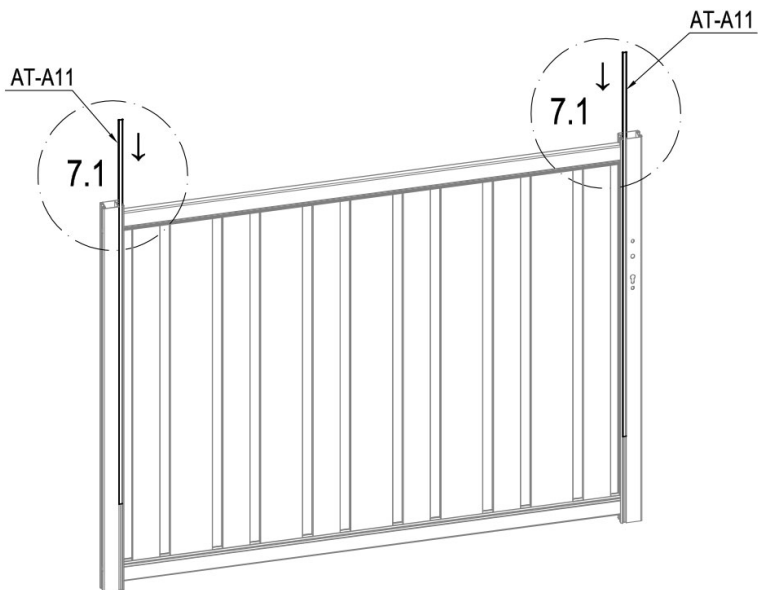

	RA-BH31	32
	RA-BH36	4

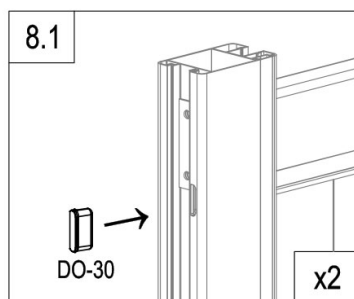
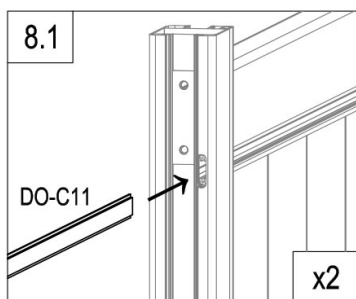
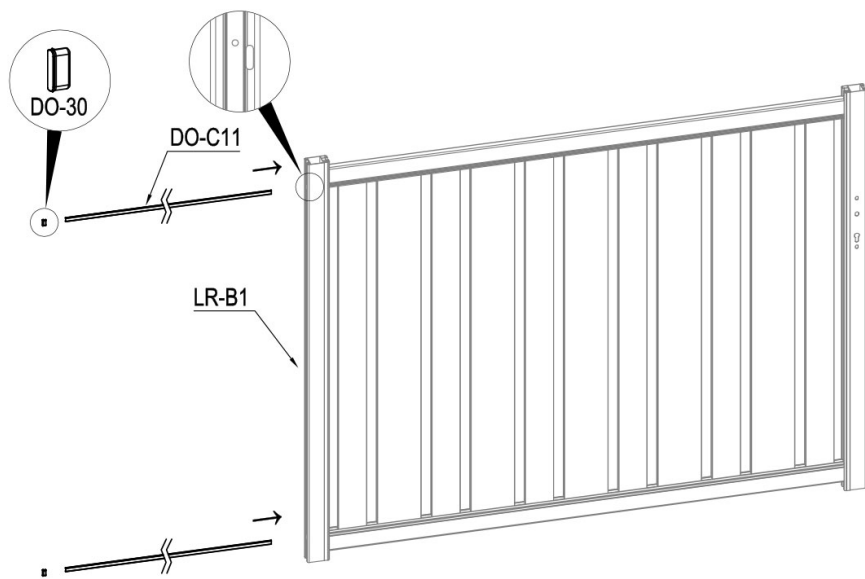

	AT-A11	2
---	--------	---



	DO-C11	2
	DO-30	2

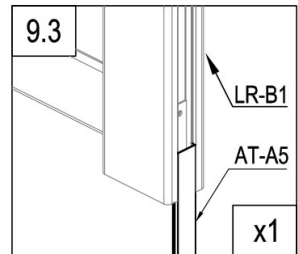
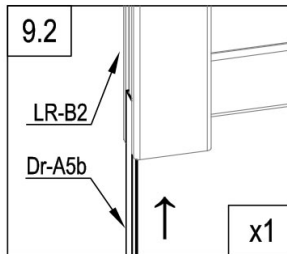
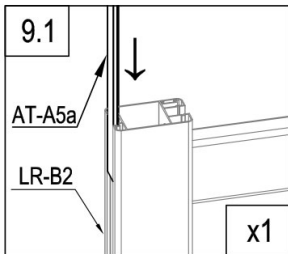
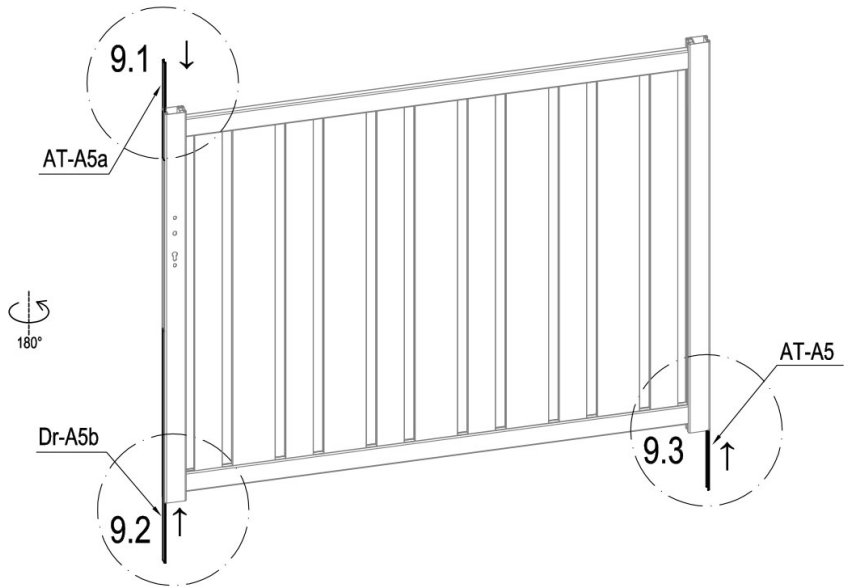

	AT-A5	1
	AT-A5a	1
	Dr-A5b	1

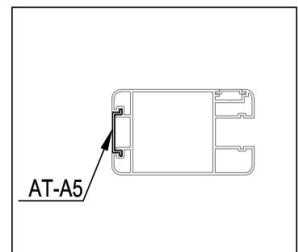

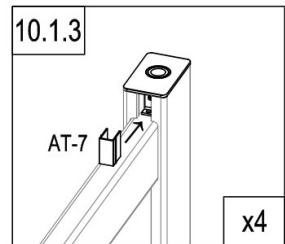
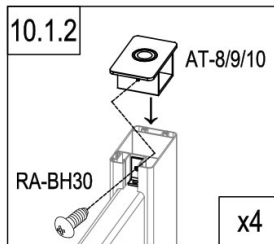
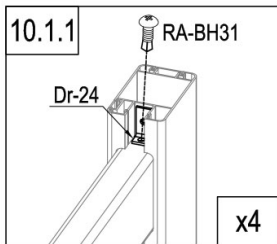
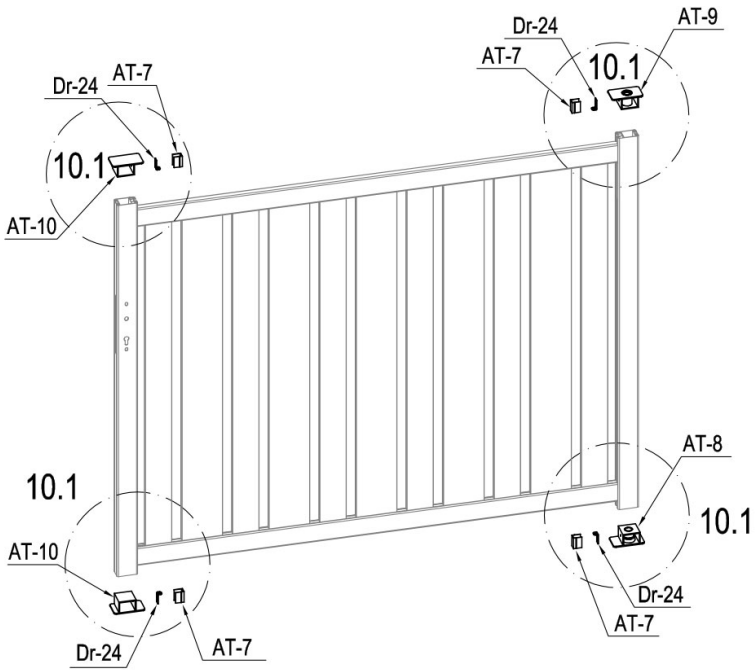

	AT-8	1
	AT-9	1
	AT-10	2
	Dr-24	4



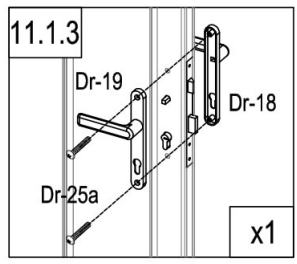
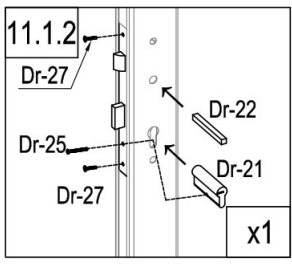
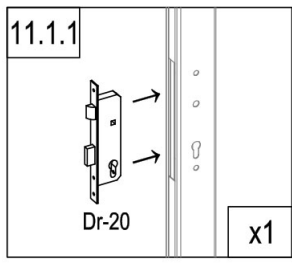
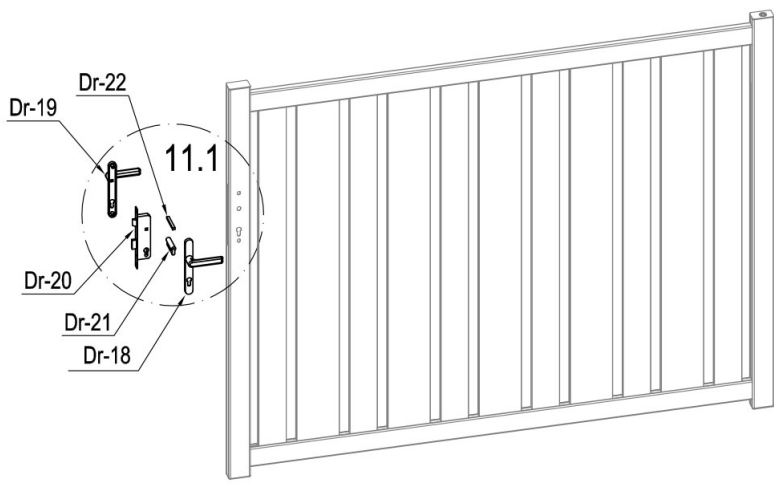

	AT-7	4
	RA-BH30	4
	RA-BH31	4



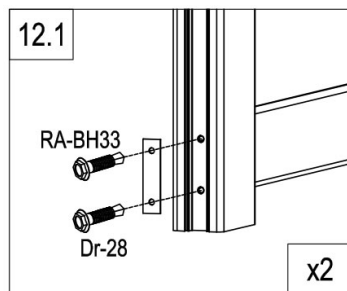
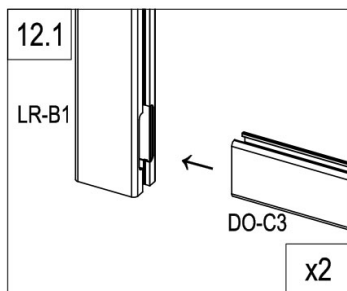
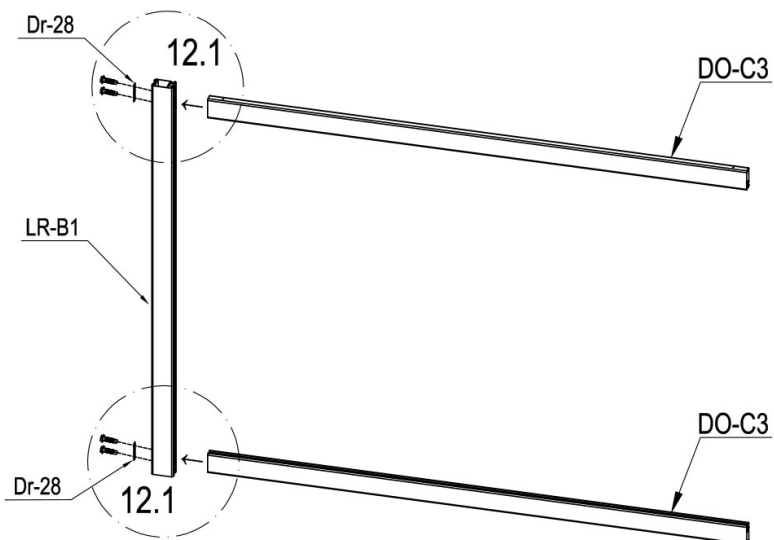

	Dr-20	1
	Dr-21	1
	Dr-22	1
	Dr-25	1

	Dr-18	1
	Dr-19	1
	Dr-25a	2
	Dr-27	2



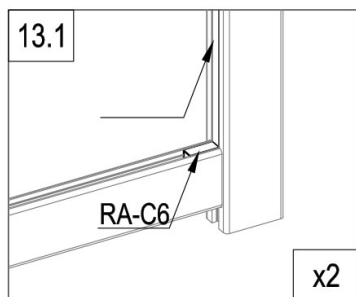
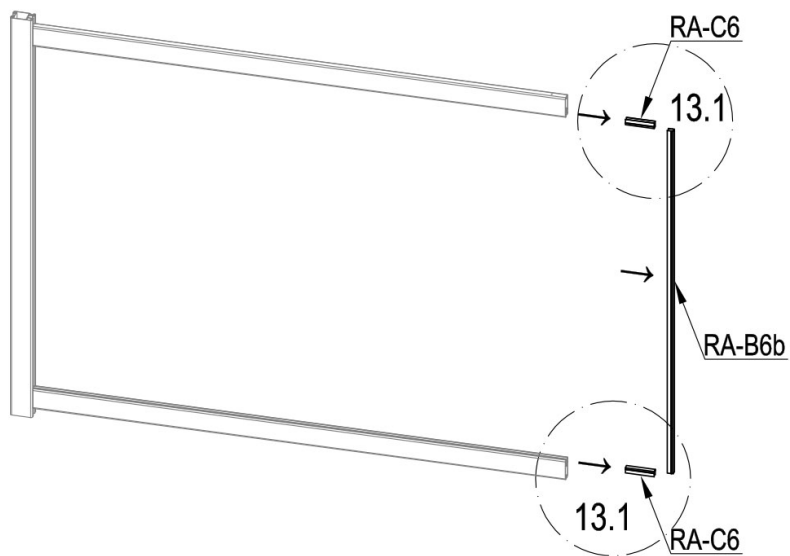



	LR-B1	1
	DO-C3	2
	Dr-28	2
	RA-BH33	4

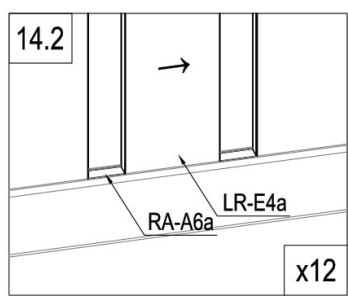
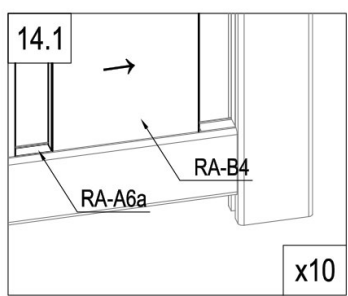
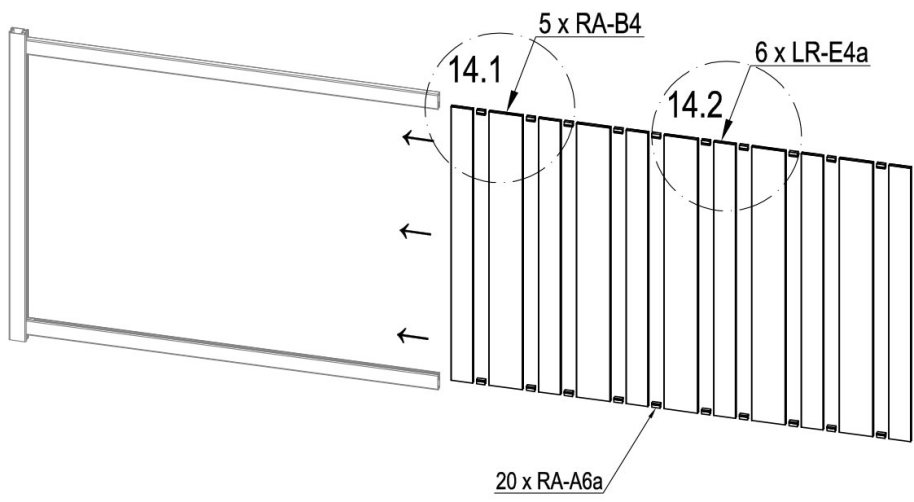

	RA-C6	2
	RA-B6b	1

CASANOVO





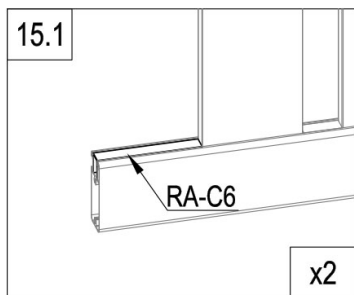
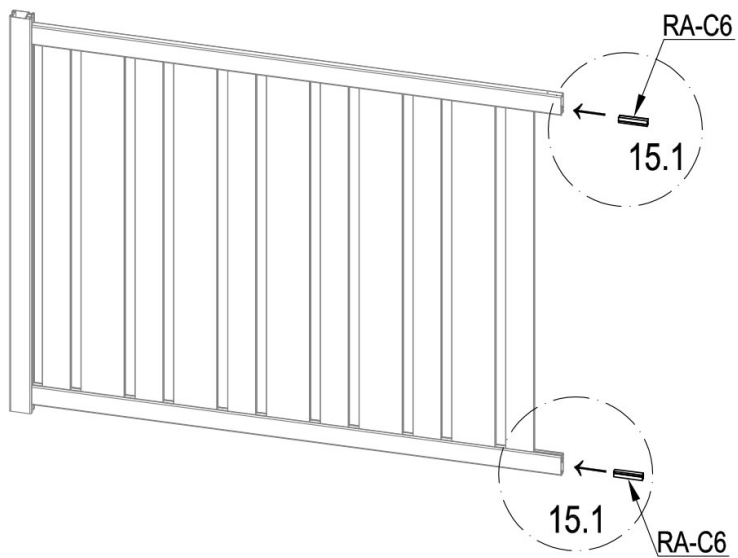

	RA-B4	5
	LR-E4a	6
	RA-A6a	20

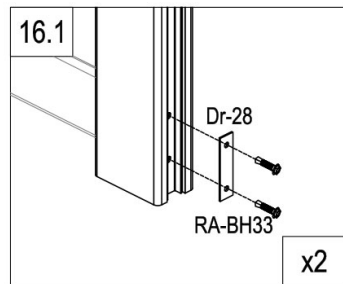
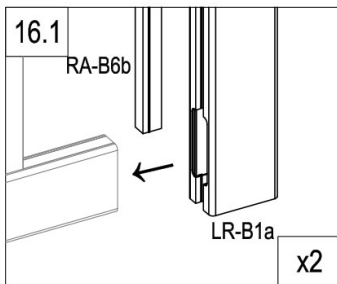
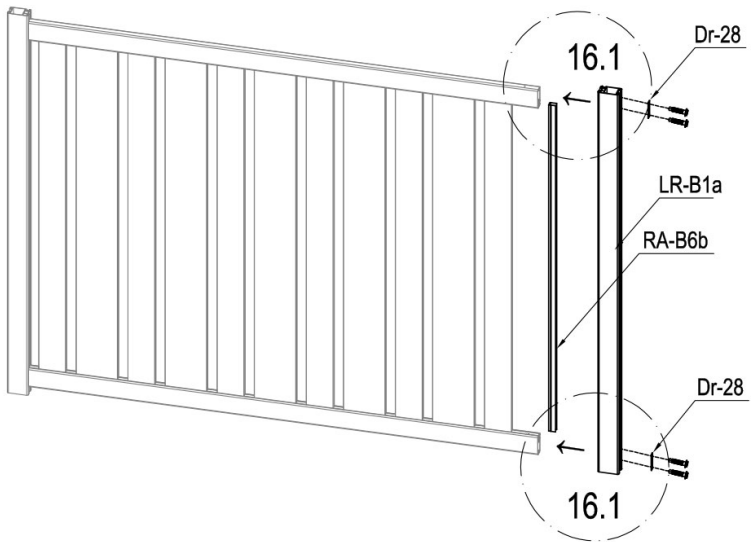

	RA-C6	2
---	-------	---



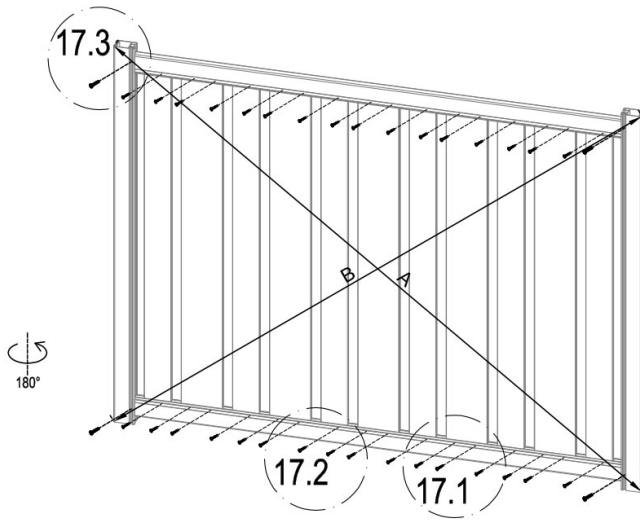

	LR-B1a	1
	RA-B6b	1
	Dr-28	2
	RA-BH33	4

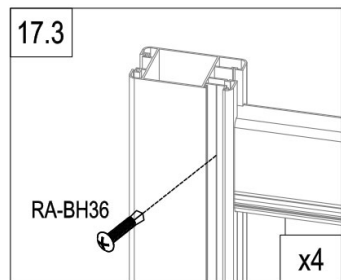
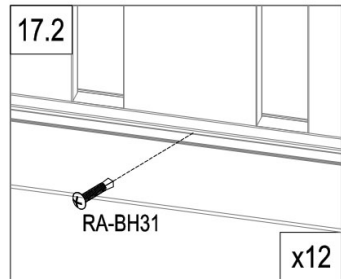
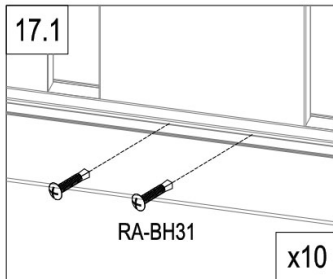

A=B



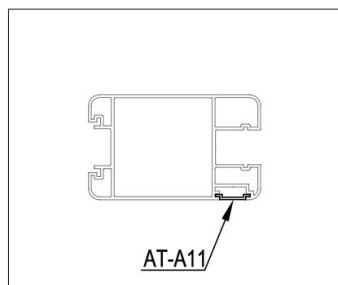
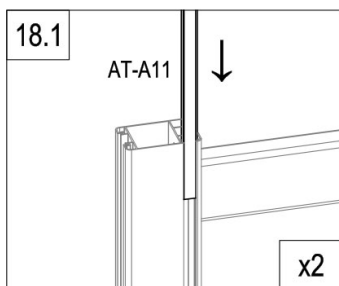
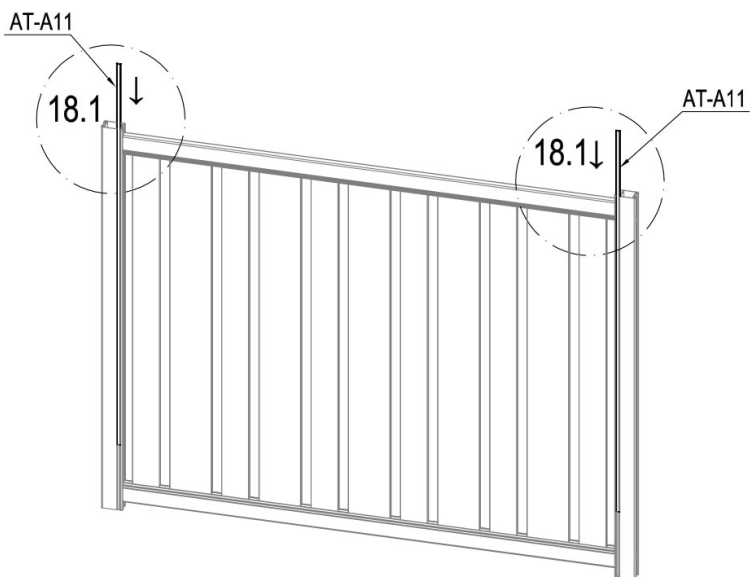

	RA-BH31	28
	RA-BH36	4



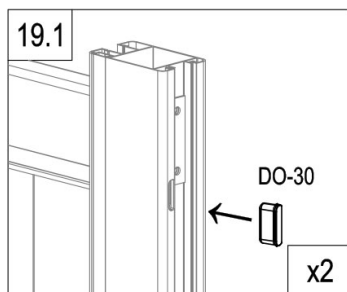
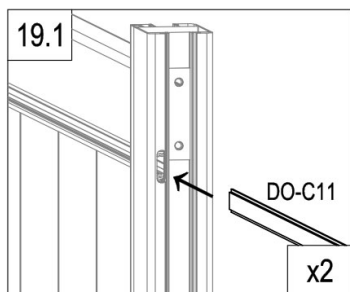
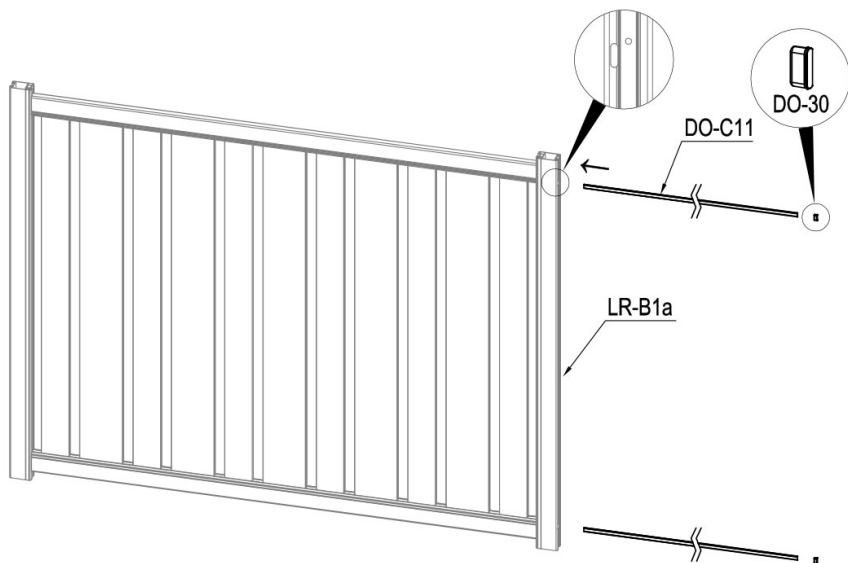

	AT-A11	2
---	--------	---

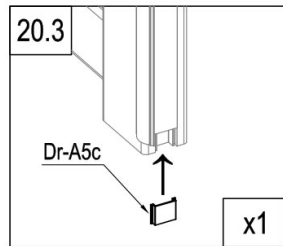
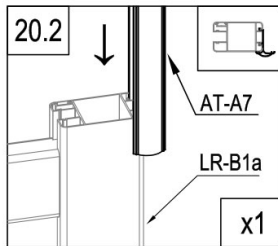
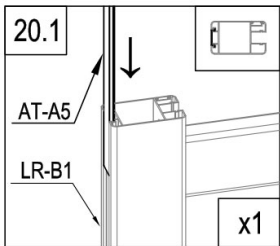
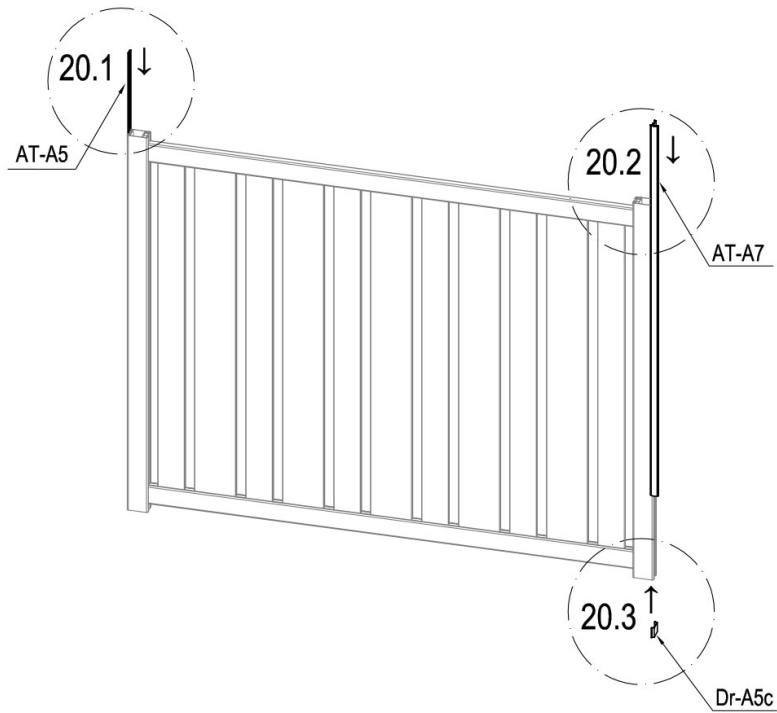

	DO-C11	2
	DO-30	2



	AT-A5	1
	Dr-A5c	1
	AT-A7	1

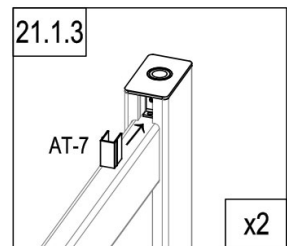
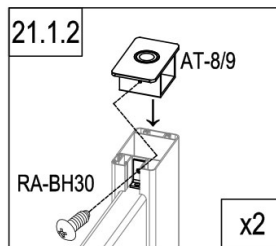
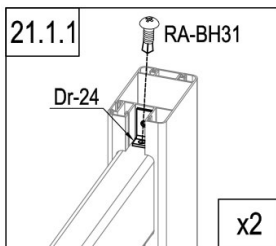
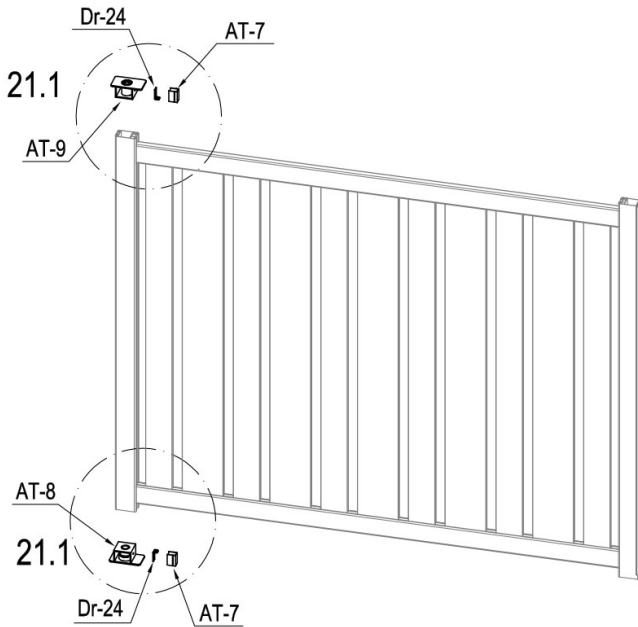

	AT-8	1
	AT-9	1
	Dr-24	2

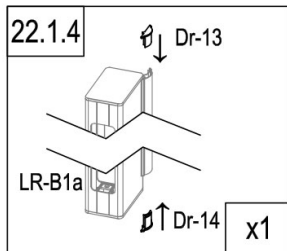
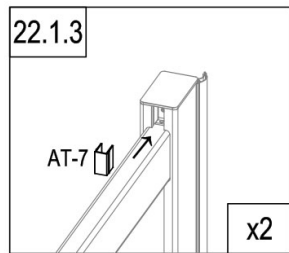
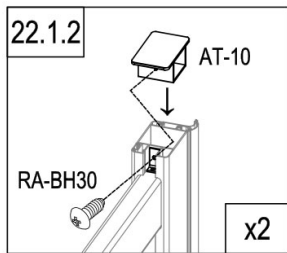
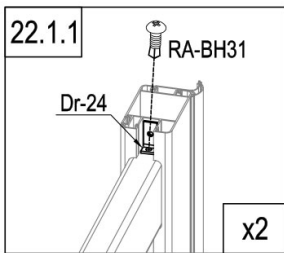
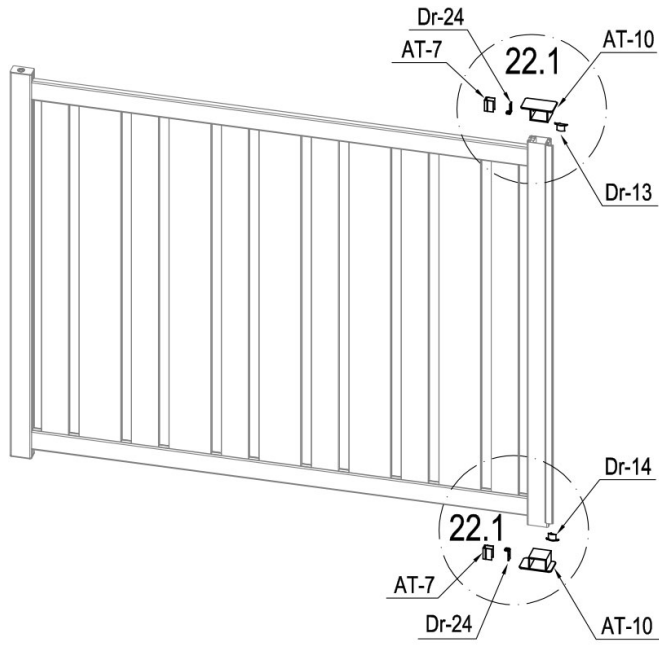

	AT-7	2
	RA-BH30	2
	RA-BH31	2



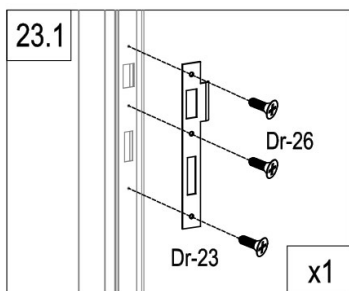
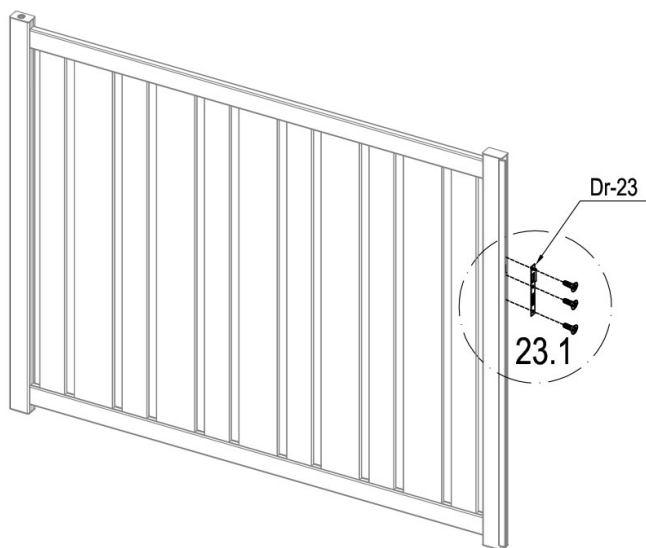

	AT-10	2
	LR-B1a	1
	RA-BH30	2
	RA-BH31	2

	AT-10	2
	LR-B1a	1
	RA-BH30	2
	RA-BH31	2

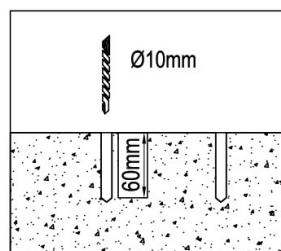
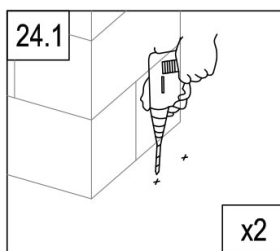
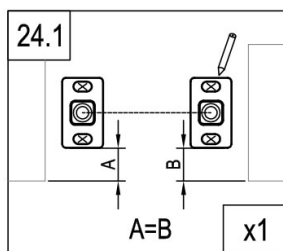
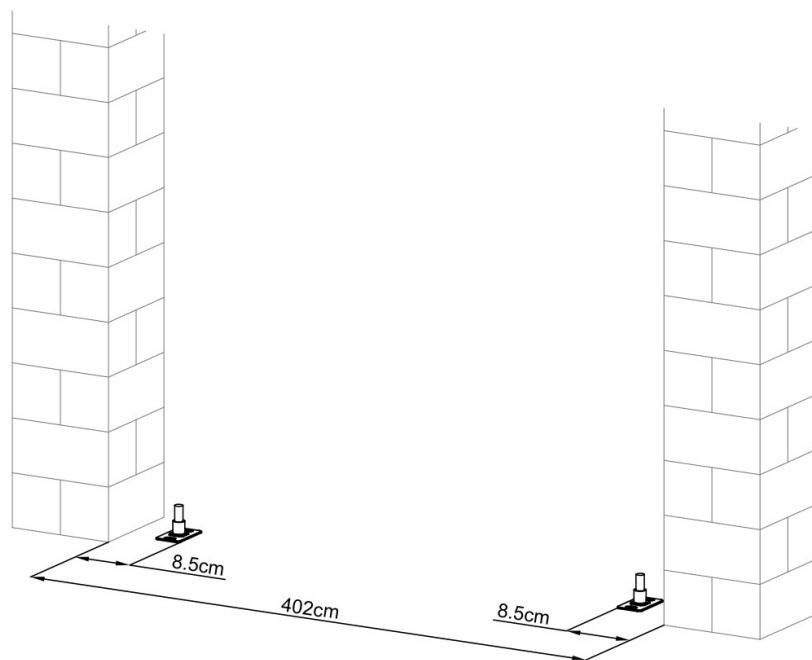

	Dr-23	1
	Dr-26	3



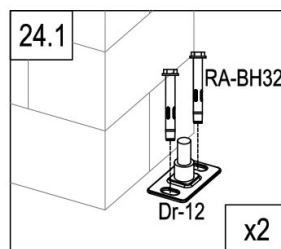

	Dr-12	2
	RA-BH32	4



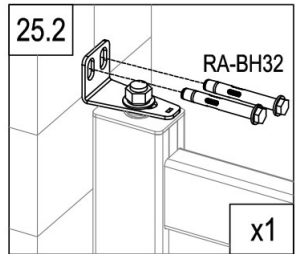
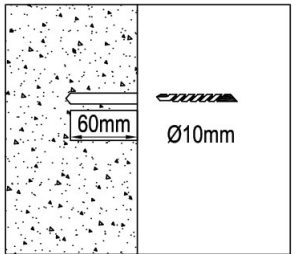
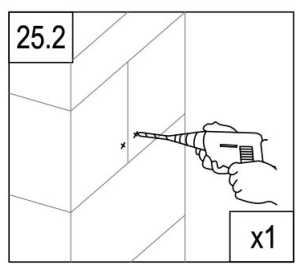
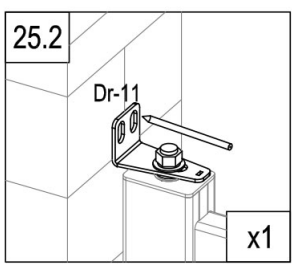
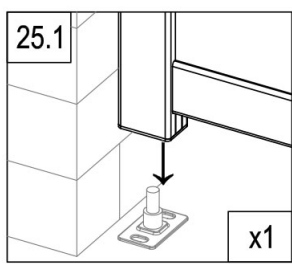
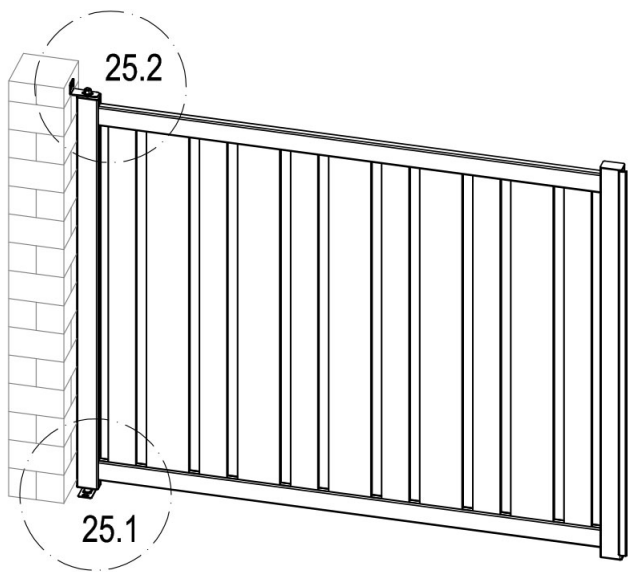

CASANOVO



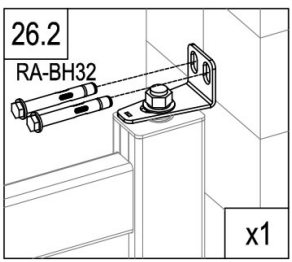
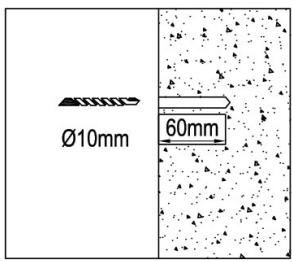
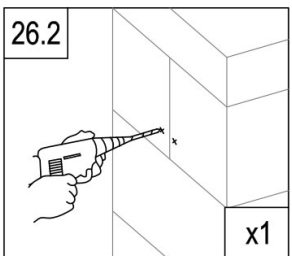
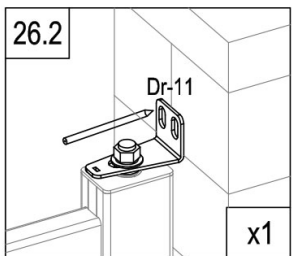
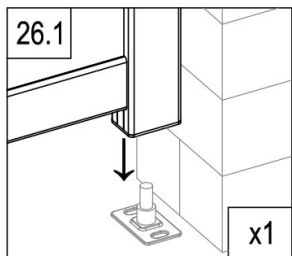
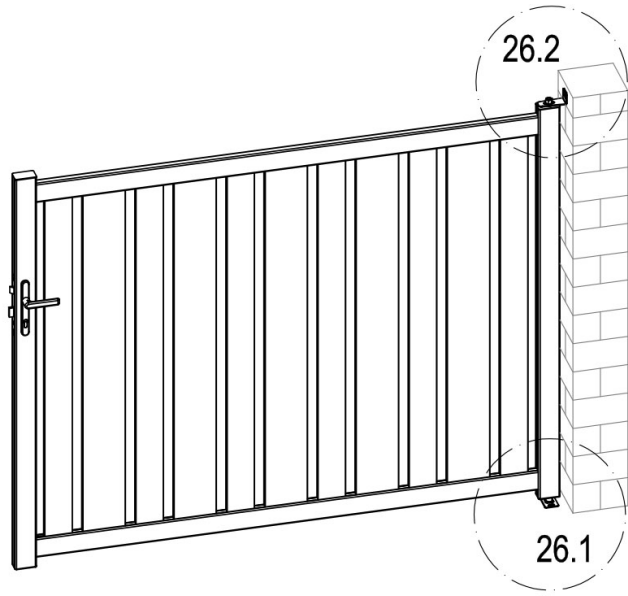

	Dr-11	1
	RA-BH32	2



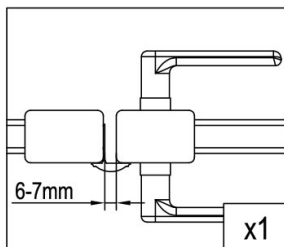
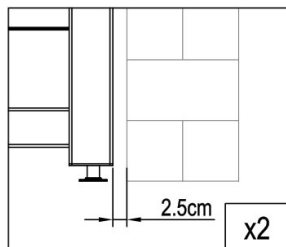
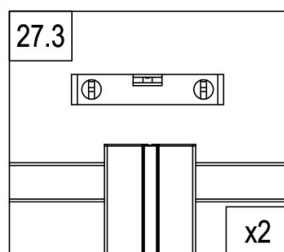
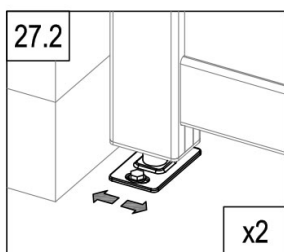
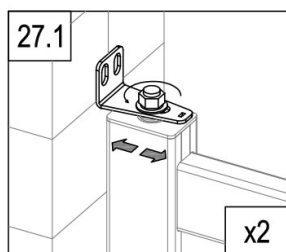
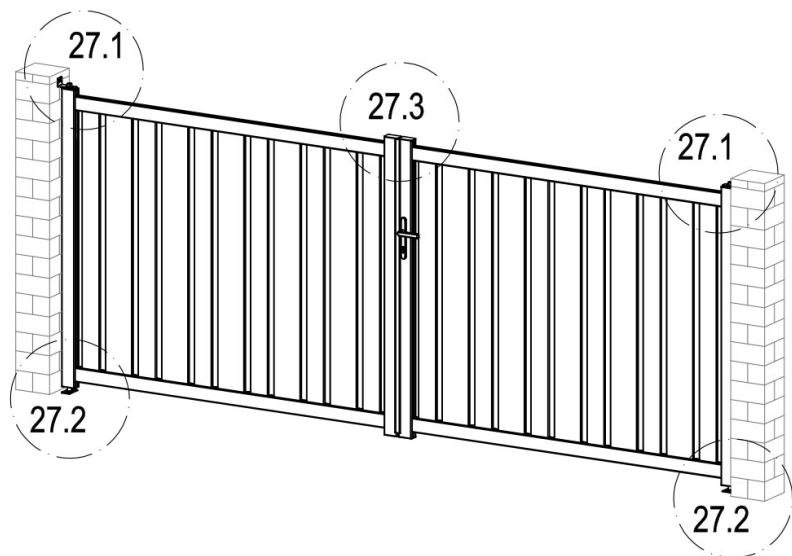

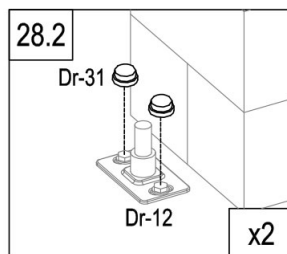
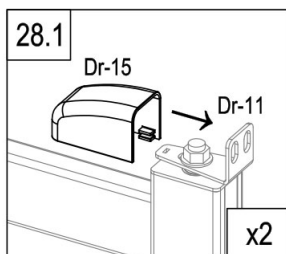
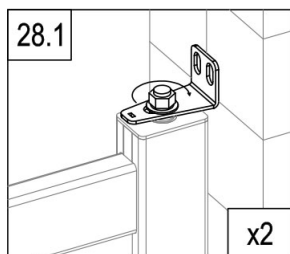
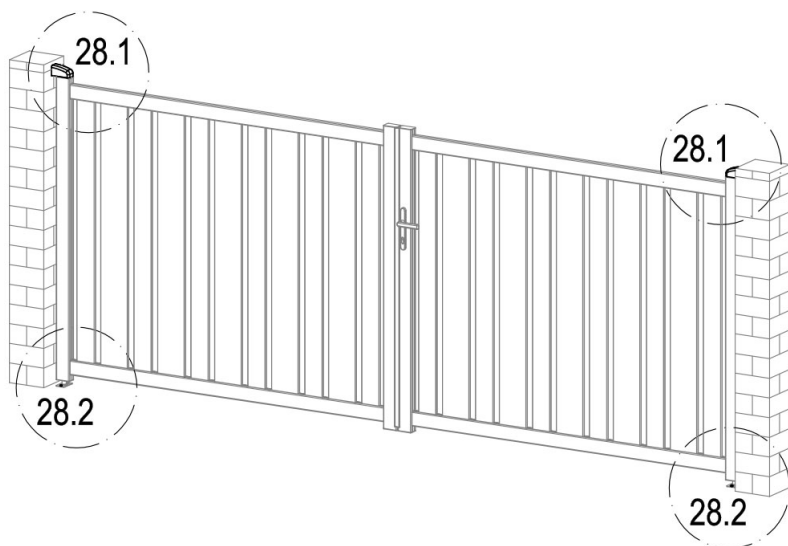

	Dr-11	1
	RA-BH32	2



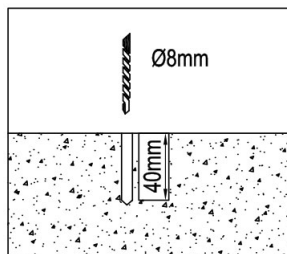
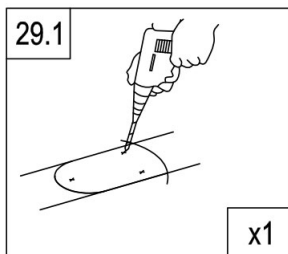
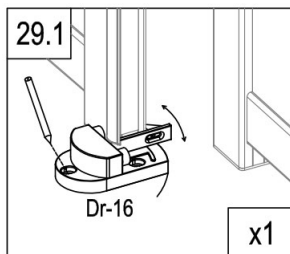
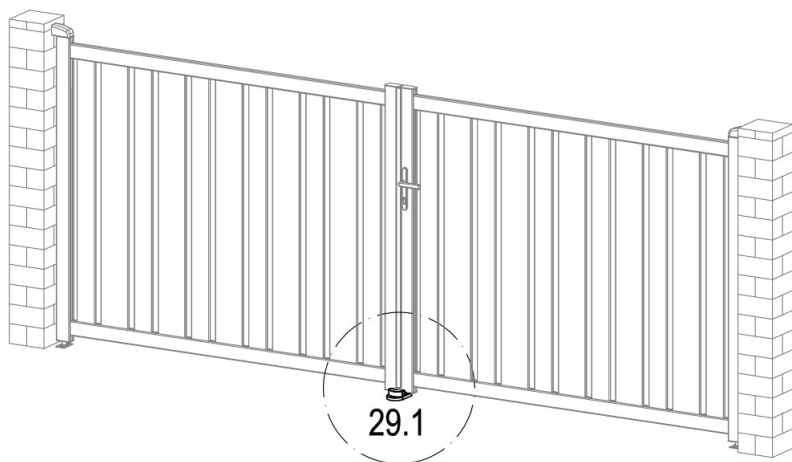

	Dr-15	2
	Dr-31	4



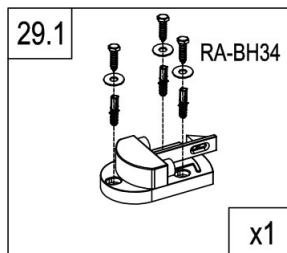

	Dr-16	1
	RA-BH34	3
	RA-BH35	3

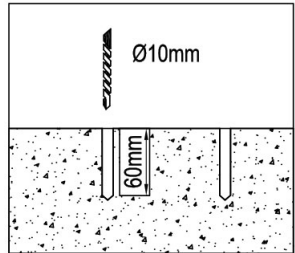
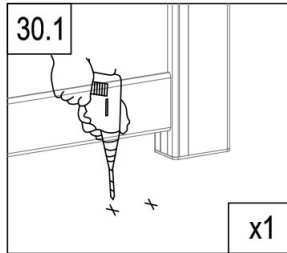
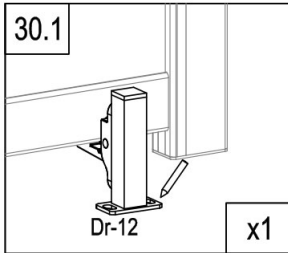
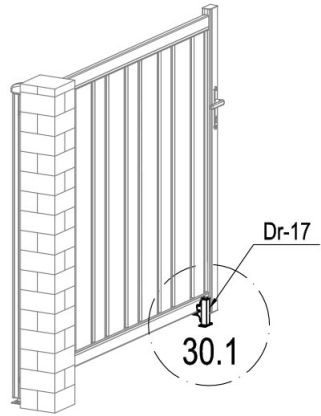
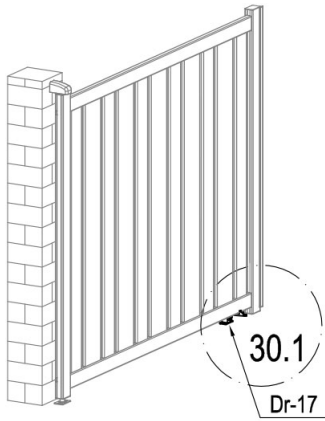

CASANOVO



	RA-BH32	4
	Dr-17	2

