

CASANOVO

VEYMONT 400B140

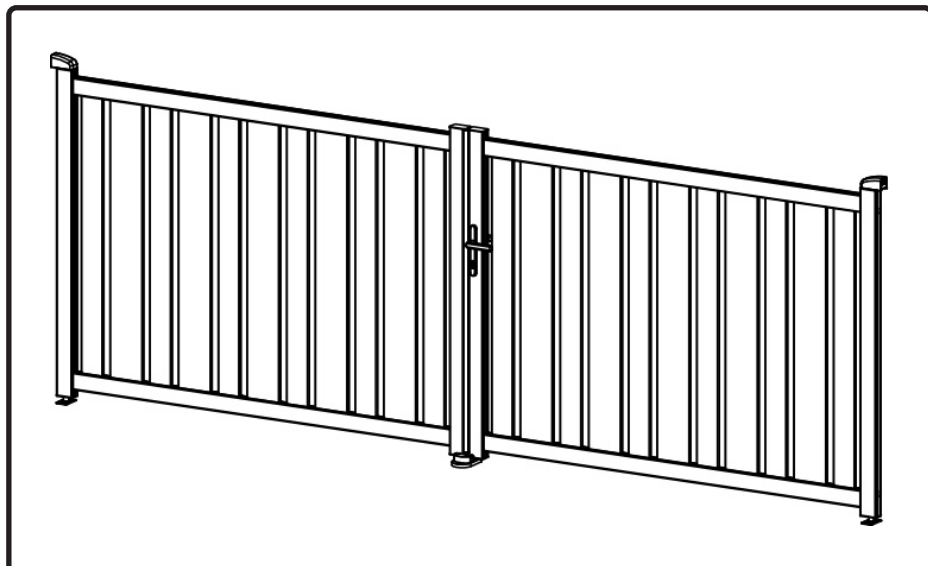

COM-000834 [x1]

COM-000835 [x1]



EN FR DE ES PT IT NL PL FI SE DK
RO SI SK HU CZ HR GR LT LV





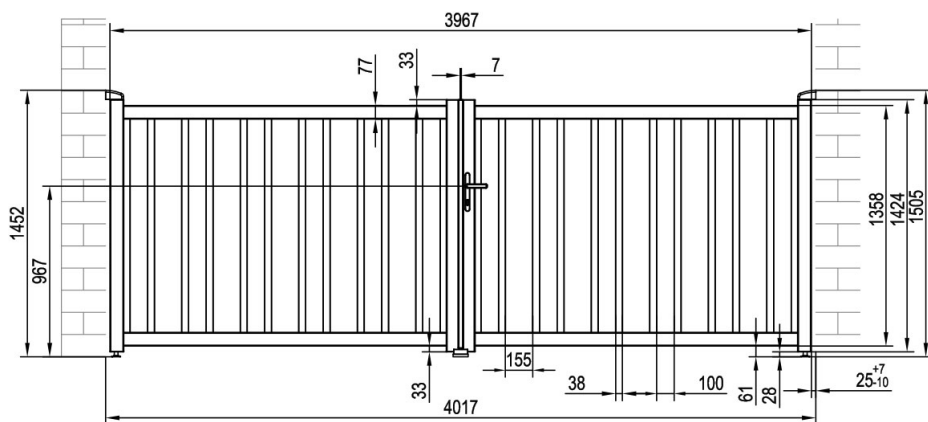

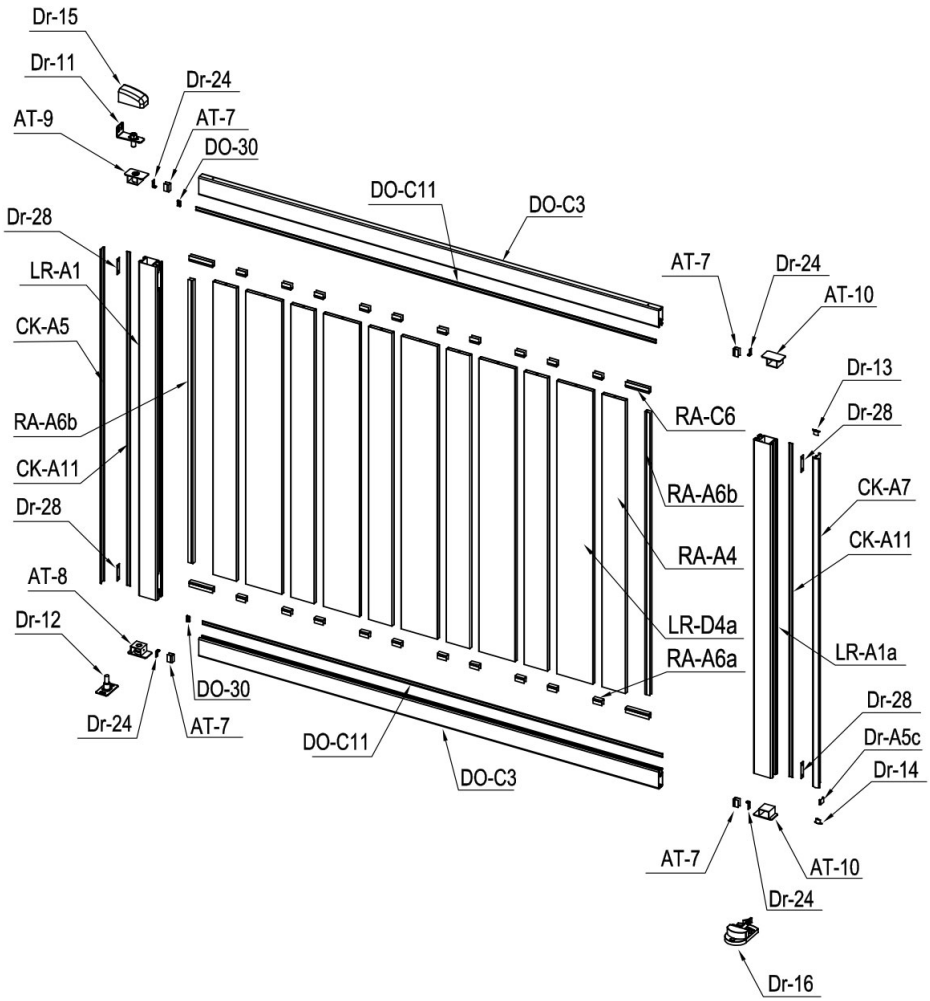

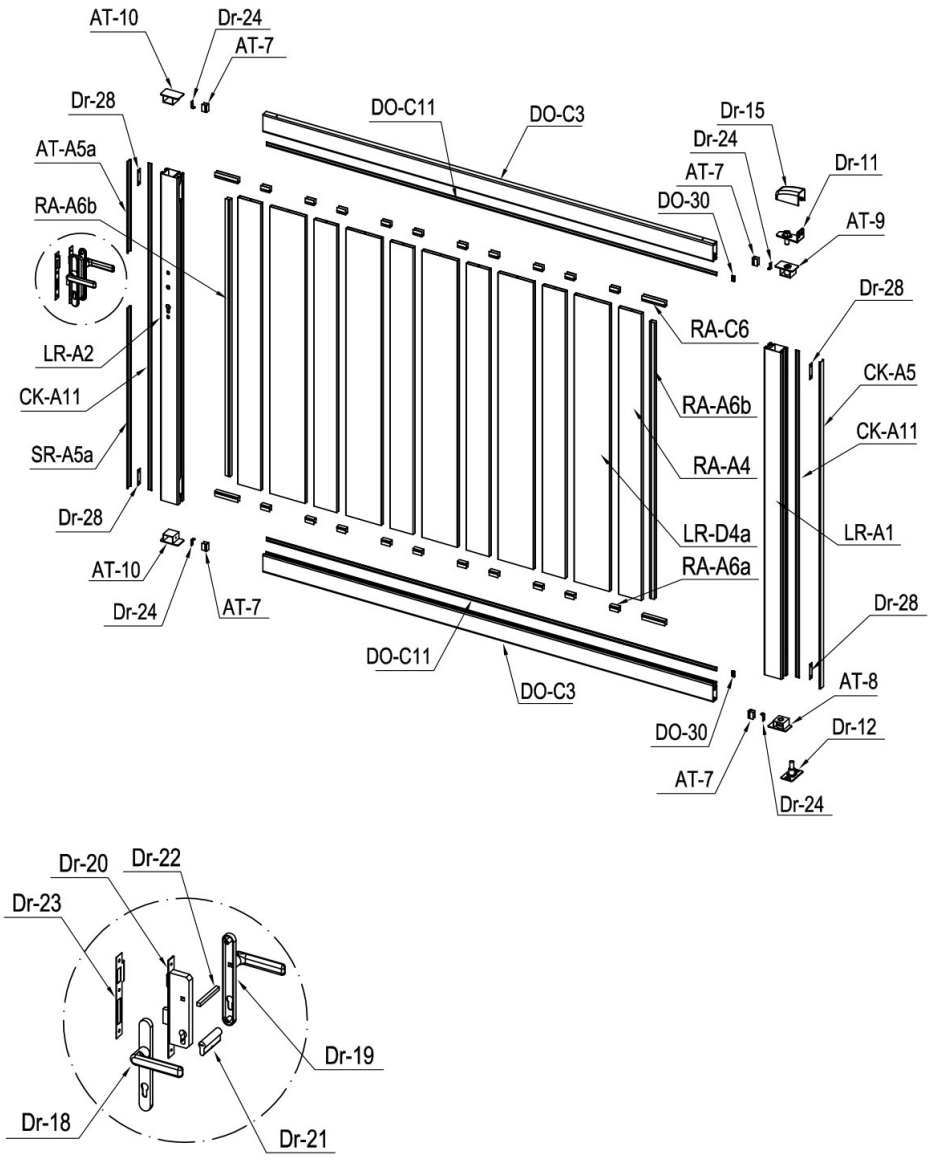































INSTRUCTION MANUAL / NOTICE DE MONTAGE / MONTAGEANLEITUNG / MANUAL DE MONTAJE / MANUAL DE MONTAGEM / MANUALE DI MONTAGGIO /
MONTAGEHANDLEIDING / INSTRUKCJA MONTAŻU / KÄYTTÖOHJEET / BRUKSANVISNING / BRUGSANVISNING / INSTRUCȚIUNI DE ASAMBLARE /
NAVODILA ZA SESTAVLJANJE / NÁVOD NA MONTÁŽ / ÖSSZESZERELÉSI ÚTMUTATÓ / NÁVOD K MONTÁŽI / UPUTE ZA INSTALACIJU /
ΟΔΗΓΙΕΣ ΣΥΝΑΡΜΟΛΟΓΗΣΗΣ / SURINKIMO INSTRUKCIJOS / MONTĀŽAS INSTRUKCIJAS











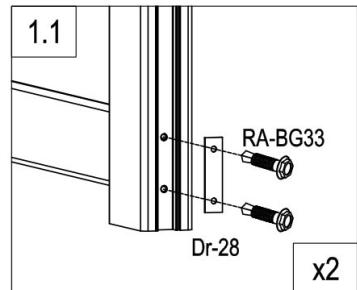
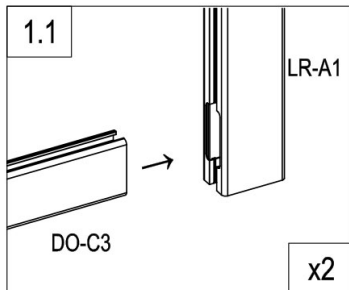
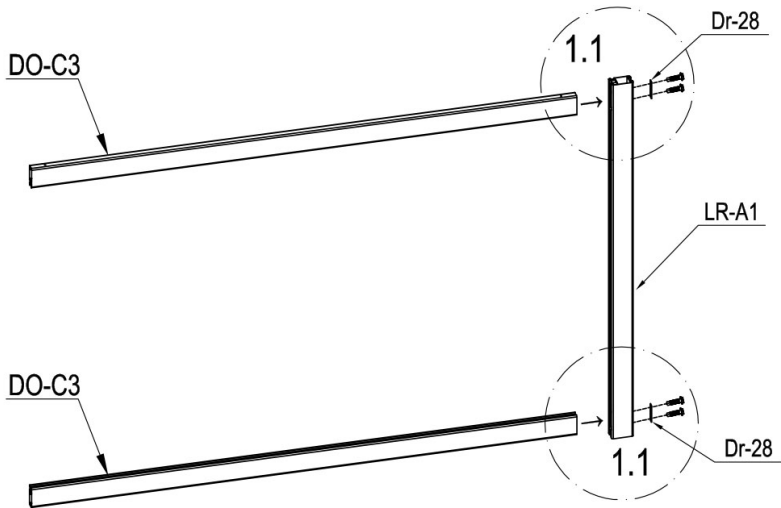

PART LIST

IMAGE	NO.	L.(mm)	QTY	IMAGE	NO.	L.(mm)	QTY
	LR-A1	1418	2		Dr-16		1
	LR-A1a	1418	1		Dr-17		2
	LR-A2	1418	1		Dr-31		4
	DO-C3	1957	4		DO-30		4
	RA-A4	1245	10		Dr-18		1
	LR-D4a	1245	12		Dr-19		1
	CK-A5	1418	2		Dr-20		1
	AT-A5a	395.5	1		Dr-21		1
	SR-A5a	782	1		Dr-22		1
	Dr-A5c	19.5	1		Dr-23		1
	CK-A11	1418	4		Dr-25	M5x45	1
	DO-C11	1957	4		Dr-25a	M5x60	2
	AT-7	29.5	8		Dr-26	ST4x12	3
	RA-A6a	38	40		Dr-27	ST4.2x25	2
	RA-A6b	1202	4		Dr-24		8
	RA-C6	100	8		Dr-28		8
	CK-A7	1398	1		RA-BG30	ST4x10	8
	AT-8		2		RA-BG31	ST4.2x13	72
	AT-9		2		RA-BG32	M8x60	12
	AT-10		4		RA-BG33	ST5.5x38	16
	Dr-11		2		RA-BG34	ST6x40	3
	Dr-12		2		RA-BG35	Ø6	3
	Dr-13		1		RA-BG36	ST4.8x38	8
	Dr-14		1				
	Dr-15		2				



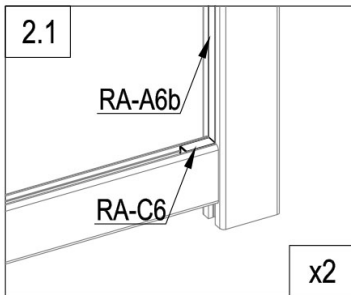
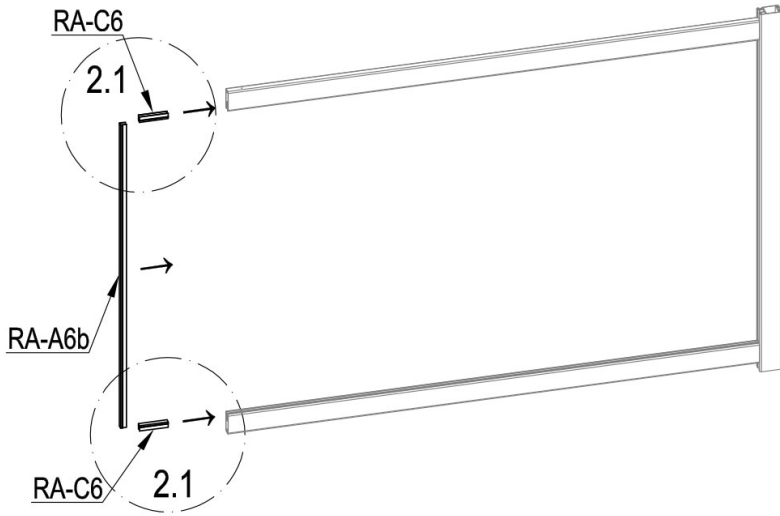

	LR-A1	1
	DO-C3	2
	Dr-28	2
	RA-BG33	4

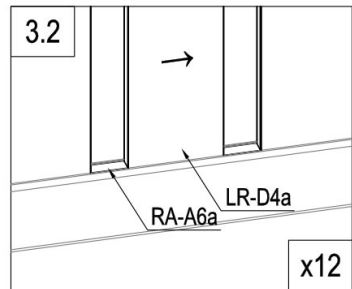
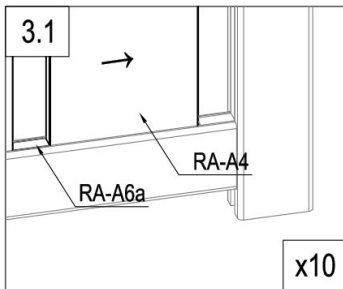
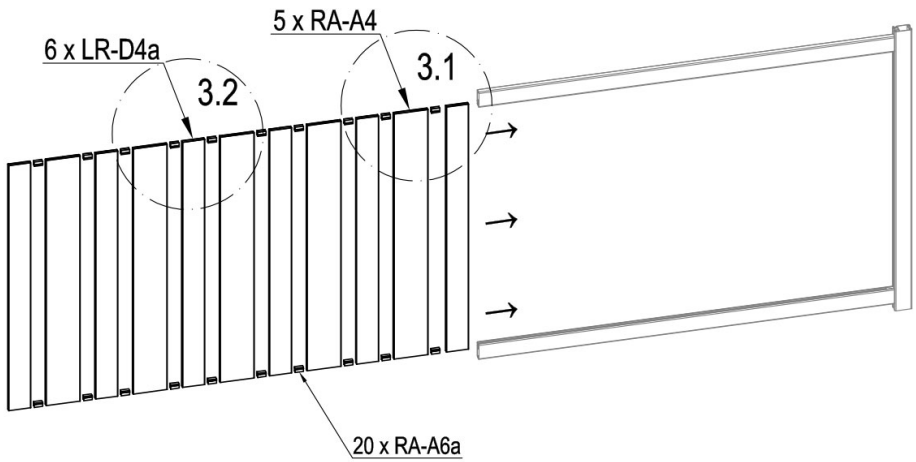

	RA-C6	2
	RA-A6b	1





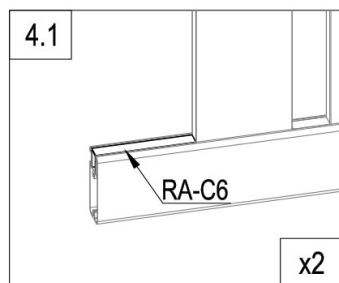
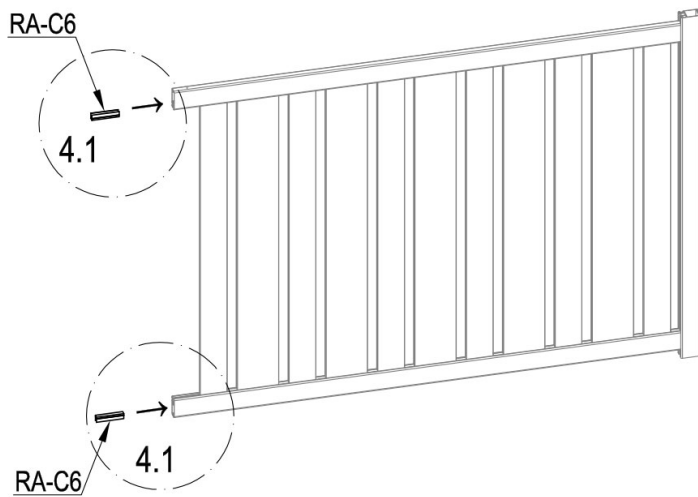

	RA-A4	5
	LR-D4a	6
	RA-A6a	20

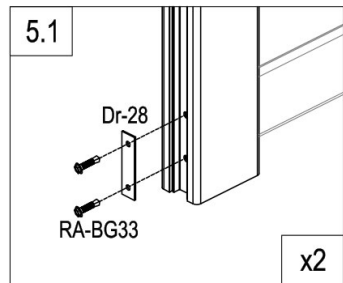
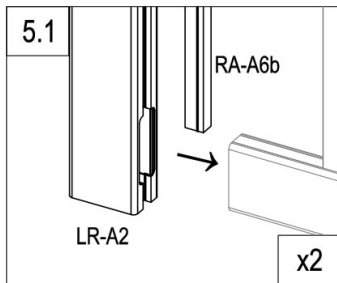
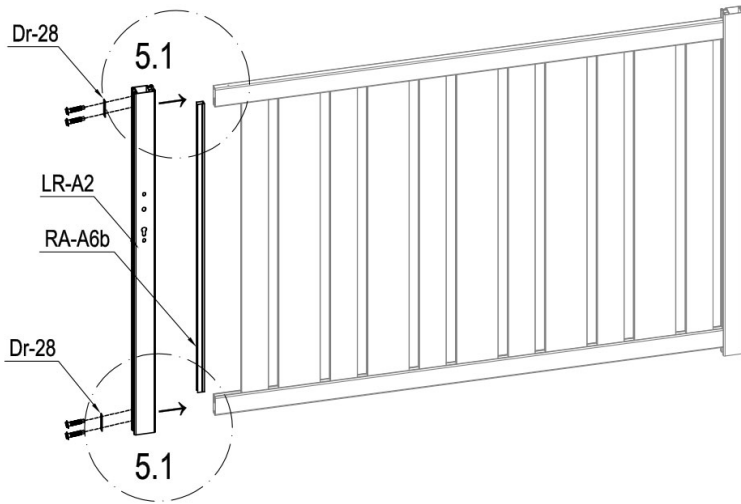

	RA-C6	2
---	-------	---



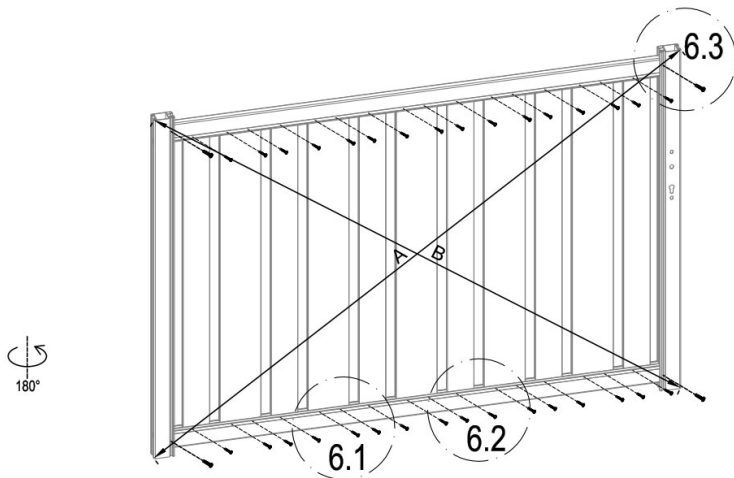

	LR-A2	1
	RA-A6b	1
	Dr-28	2
	RA-BG33	4

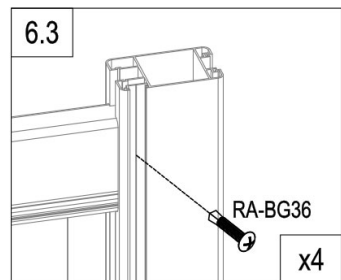
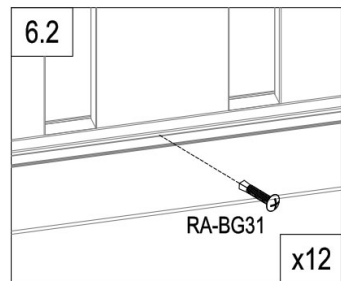
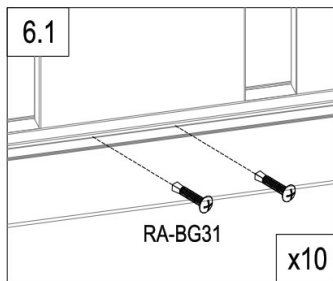

A=B



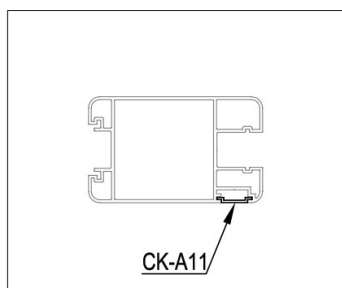
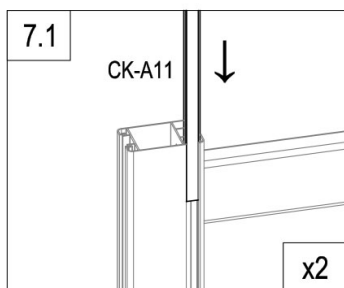
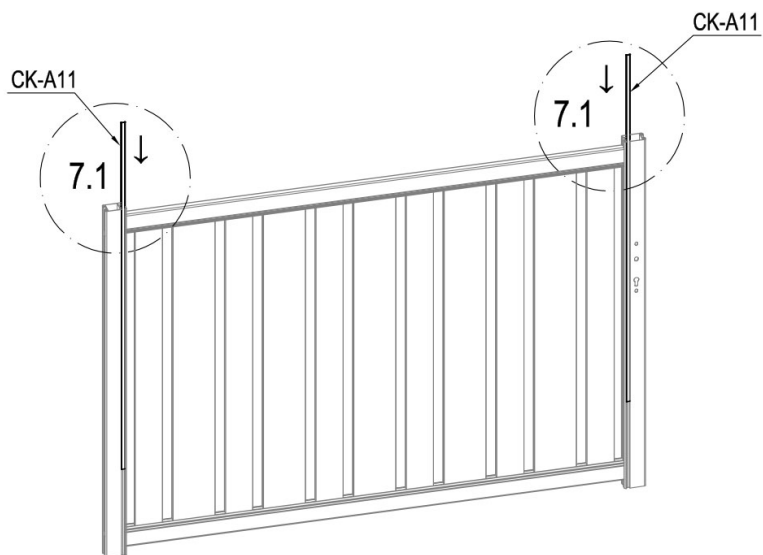

	RA-BG31	32
	RA-BG36	4

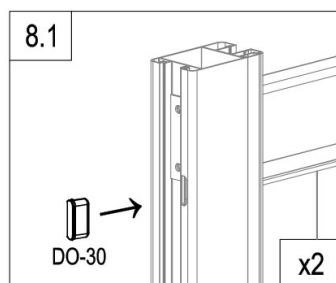
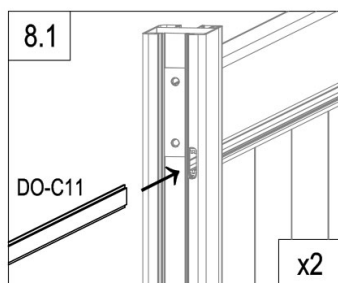
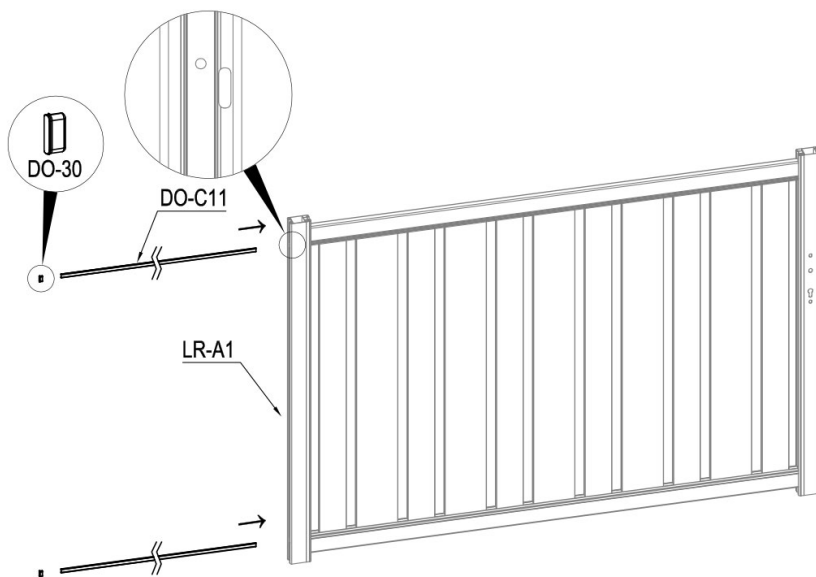

	CK-A11	2
---	--------	---



	DO-C11	2
	DO-30	2

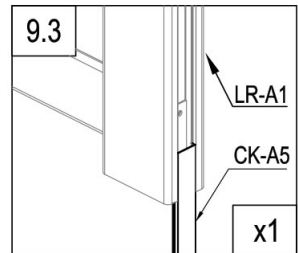
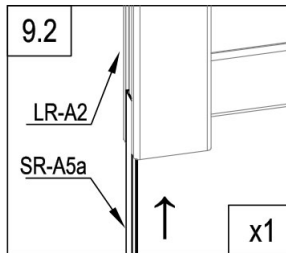
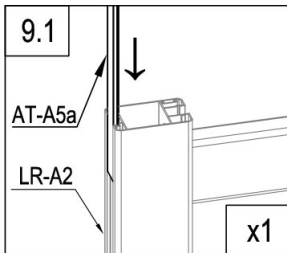
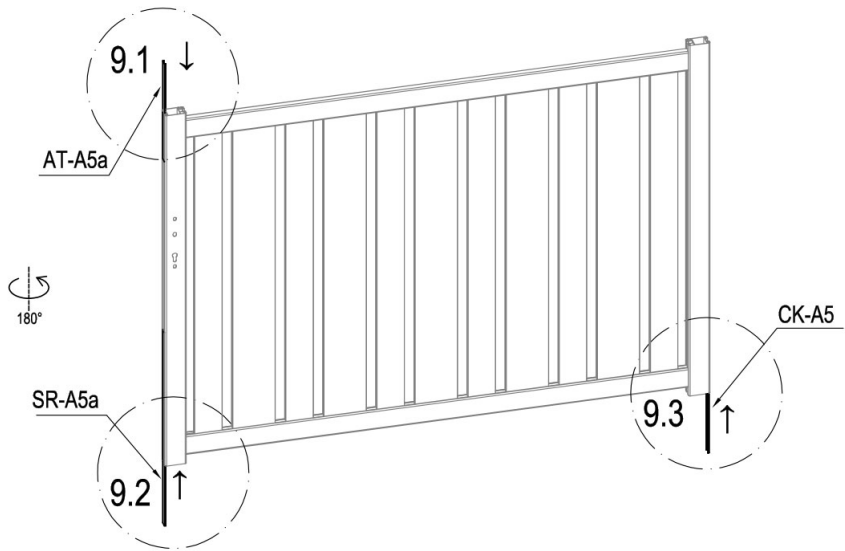

	CK-A5	1
	AT-A5a	1
	SR-A5a	1

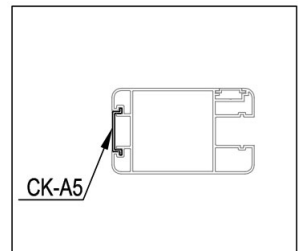

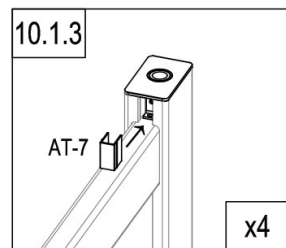
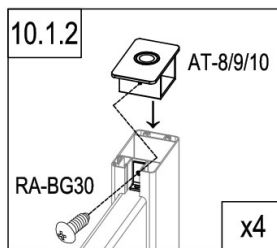
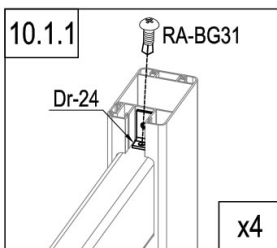
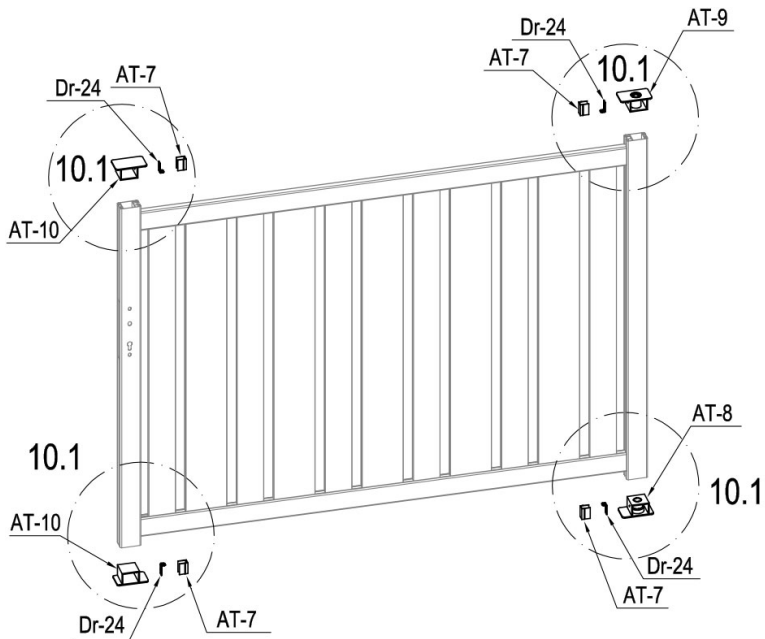

	AT-8	1
	AT-9	1
	AT-10	2
	Dr-24	4



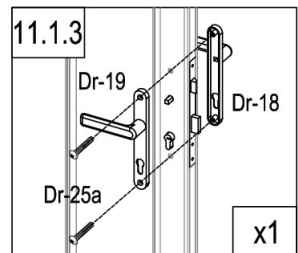
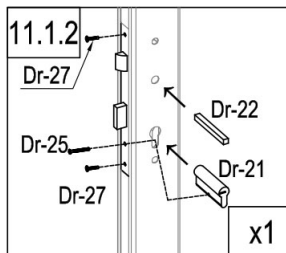
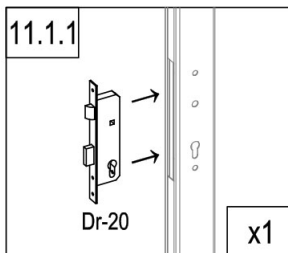
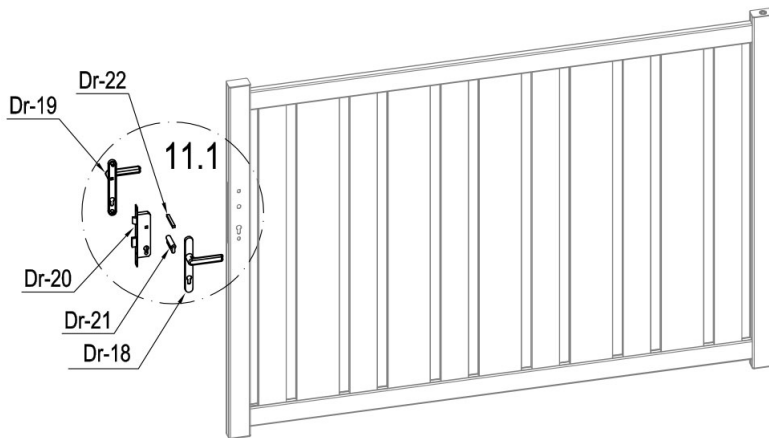

	AT-7	4
	RA-BG30	4
	RA-BG31	4



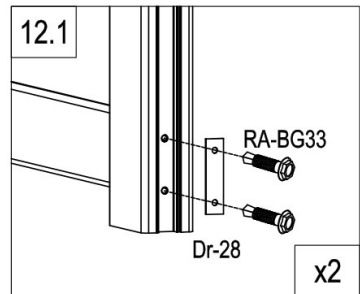
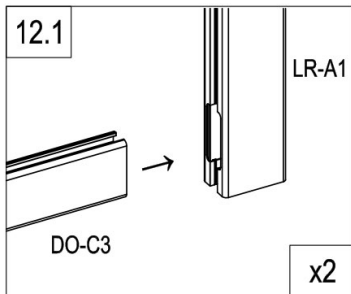
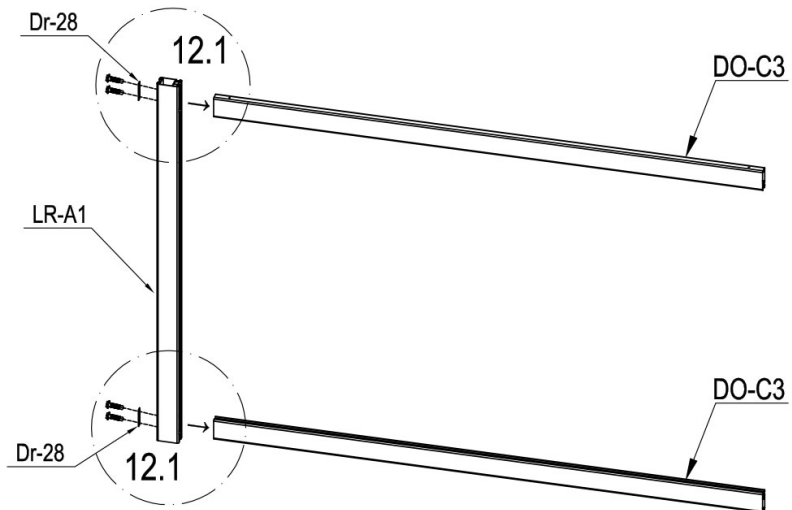

	Dr-20	1
	Dr-21	1
	Dr-22	1
	Dr-25	1

	Dr-18	1
	Dr-19	1
	Dr-25a	2
	Dr-27	2



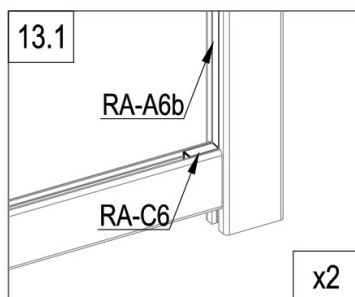
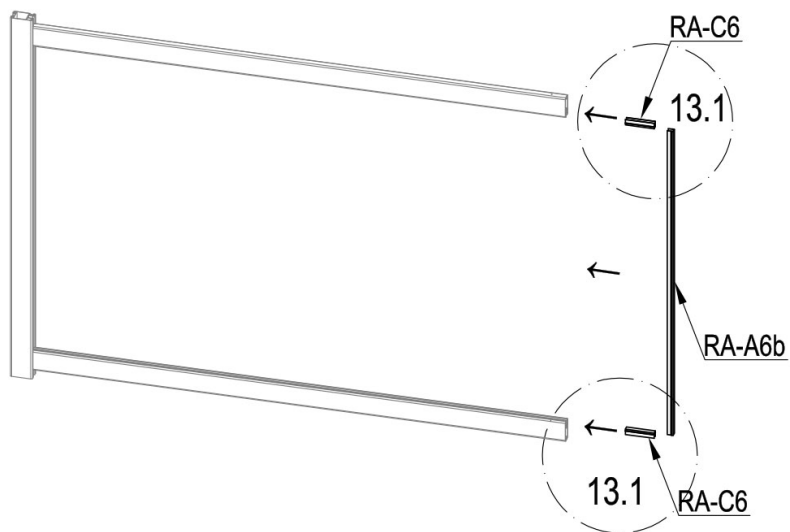

	LR-A1	1
	DO-C3	2
	Dr-28	2
	RA-BG33	4

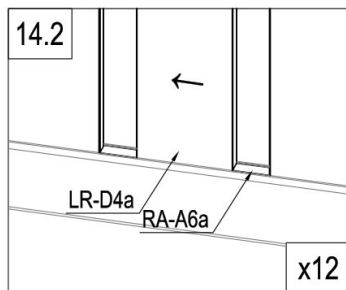
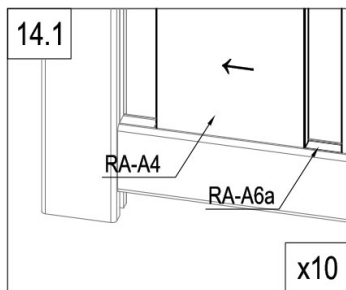
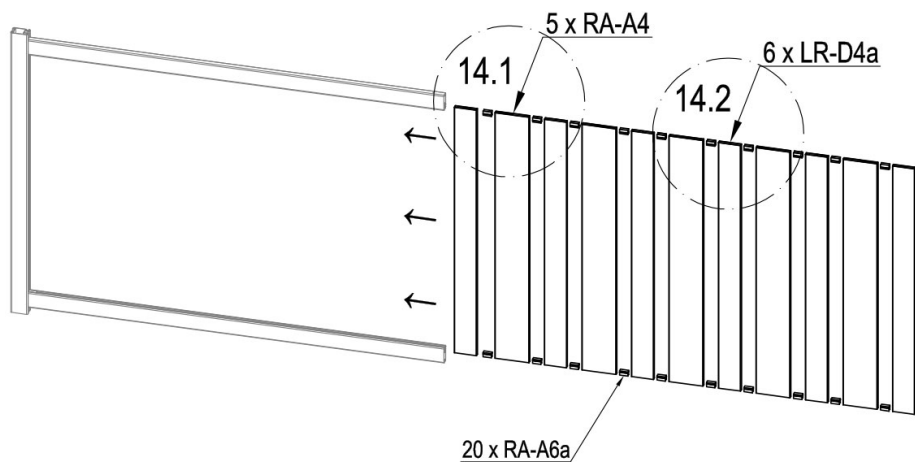

	RA-C6	2
	RA-A6b	1





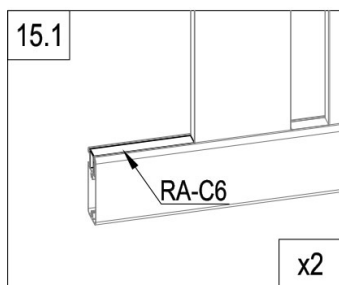
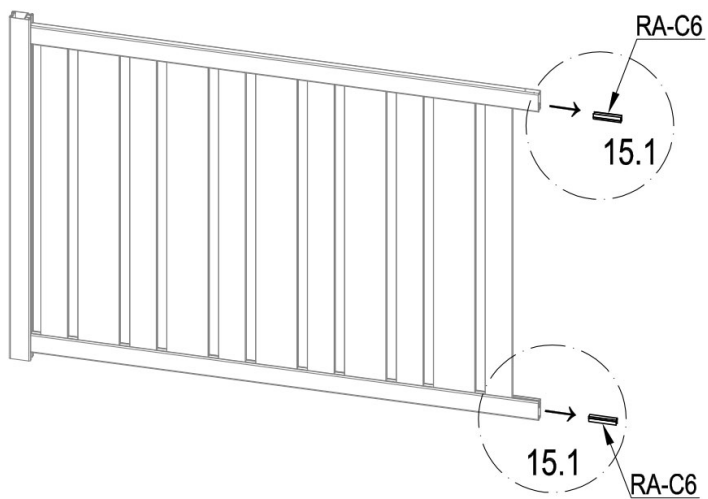

	RA-A4	5
	LR-D4a	6
	RA-A6a	20

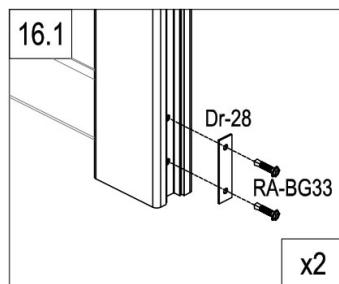
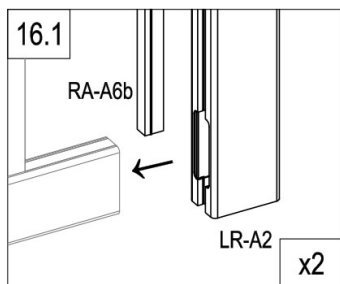
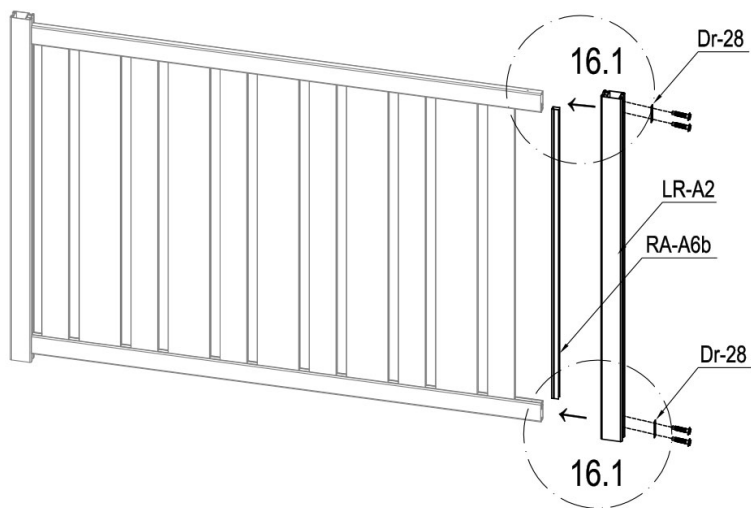

	RA-C6	2
---	-------	---



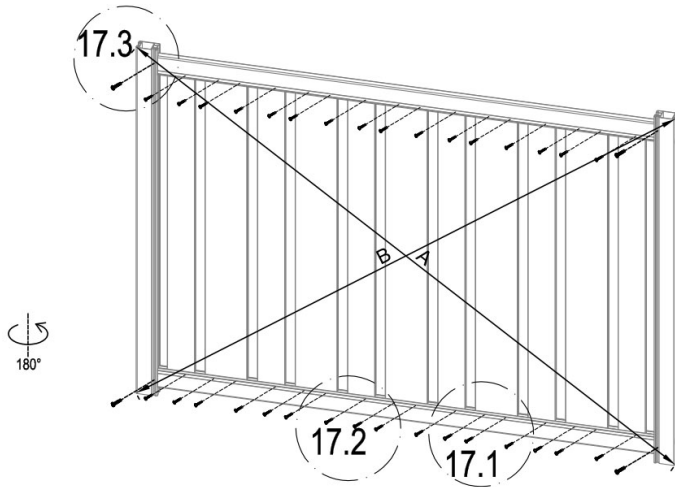

	LR-A2	1
	RA-A6b	1
	Dr-28	2
	RA-BG33	4

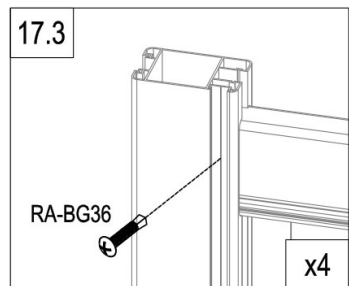
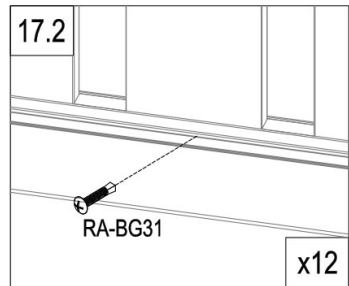
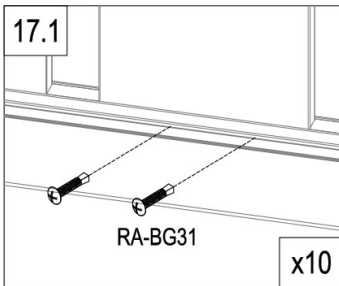

A=B



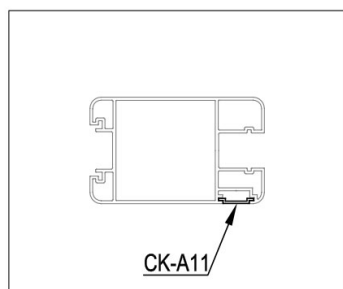
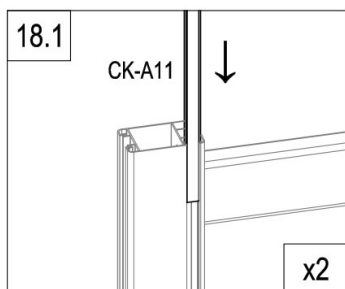
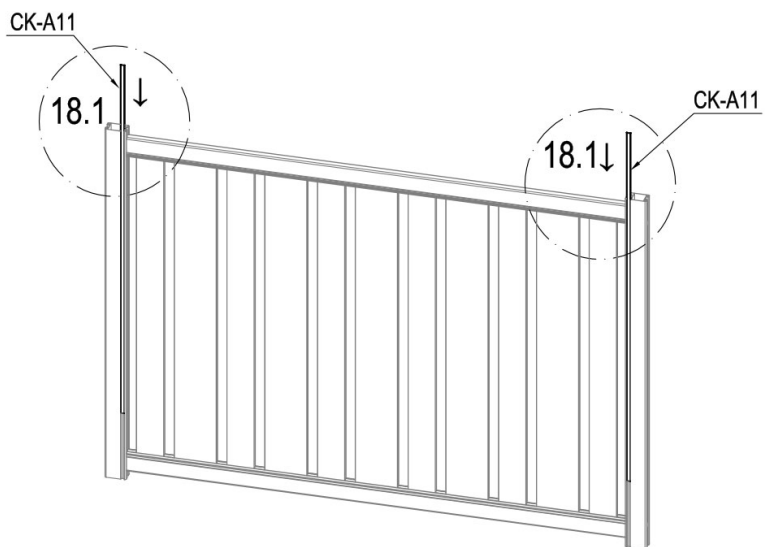

	RA-BG31	28
	RA-BG36	4



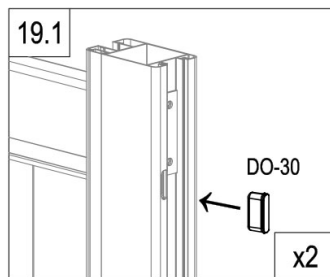
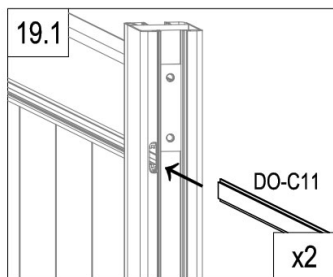
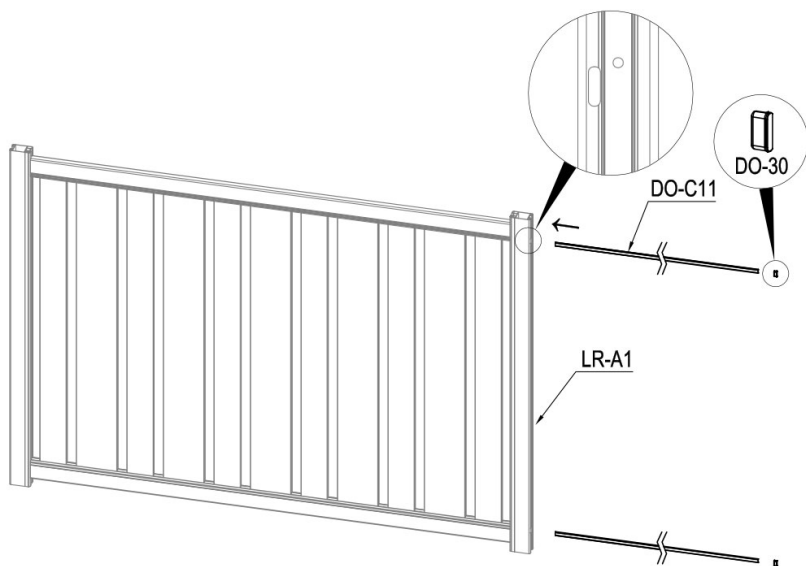

	CK-A11	2
---	--------	---

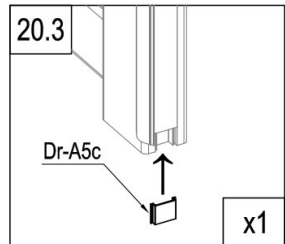
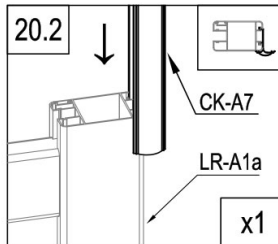
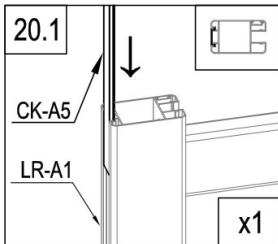
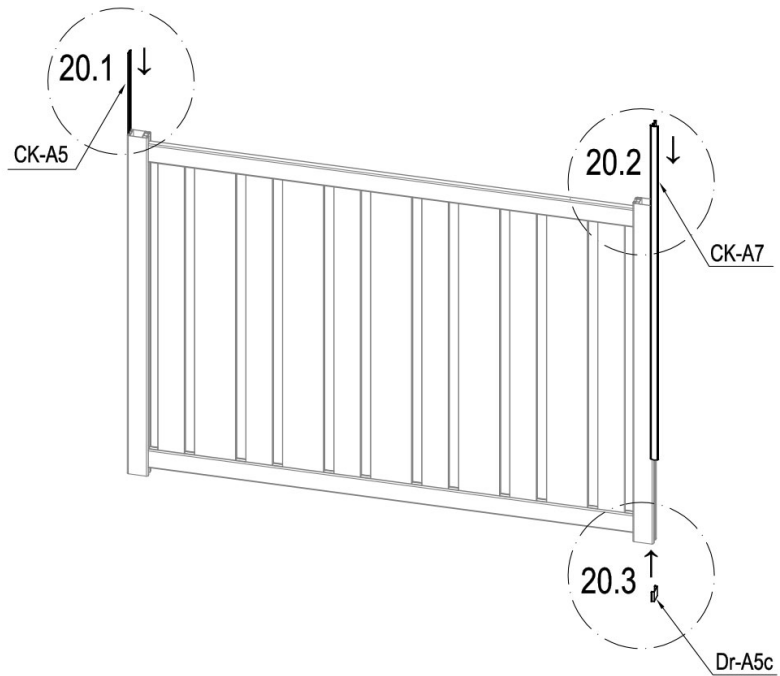

	DO-C11	2
	DO-30	2



	CK-A5	1
	Dr-A5c	1
	CK-A7	1

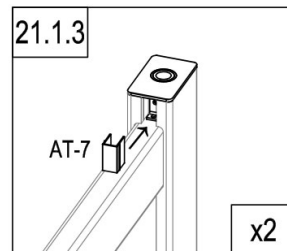
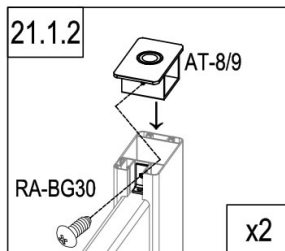
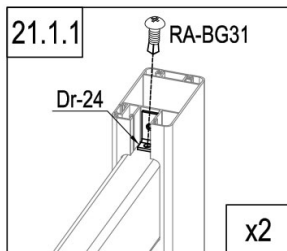
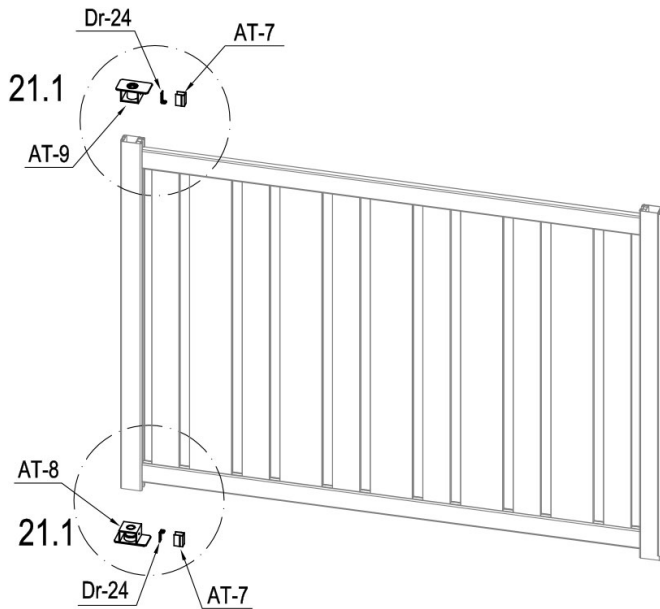

	AT-8	1
	AT-9	1
	Dr-24	2

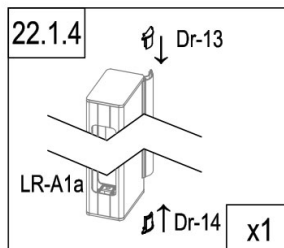
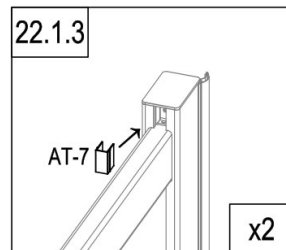
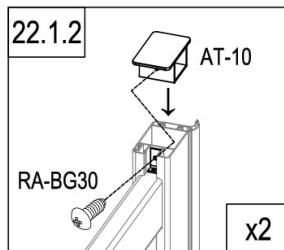
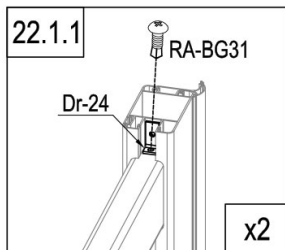
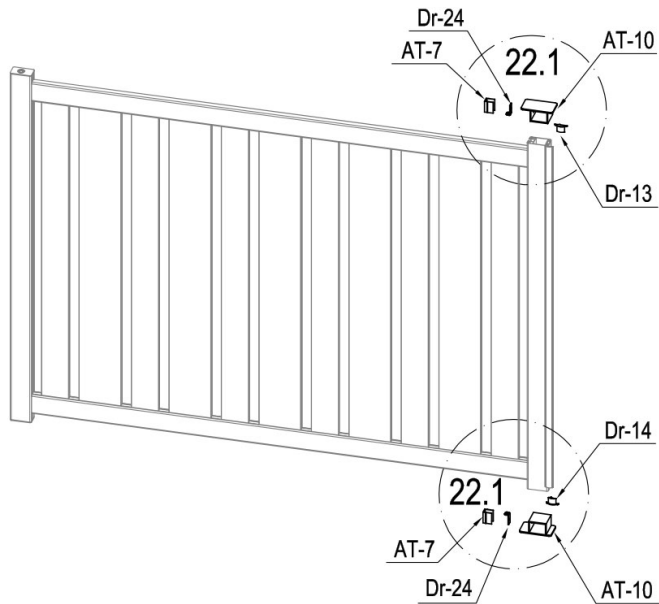

	AT-7	2
	RA-BG30	2
	RA-BG31	2



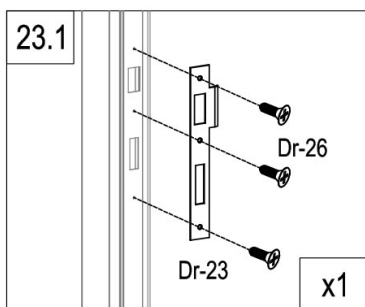
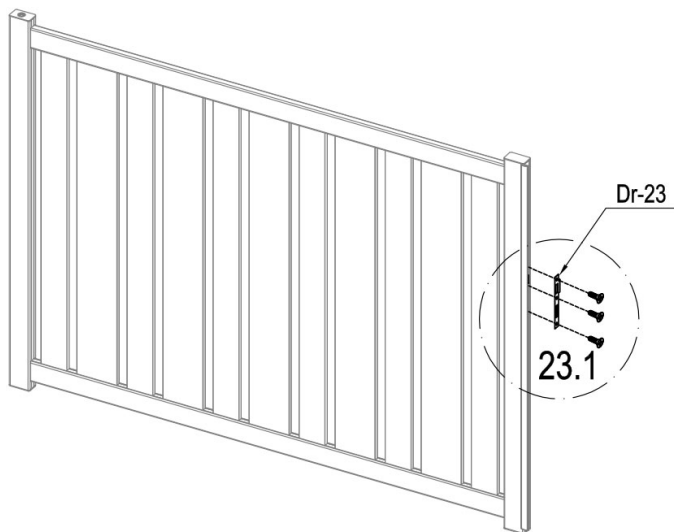

	AT-10	2
	Dr-24	2
	AT-7	2
	Dr-13	1

	Dr-14	1
	RA-BG30	2
	RA-BG31	2

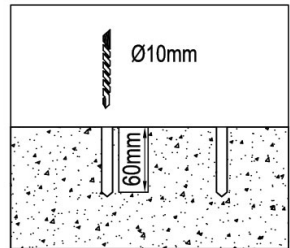
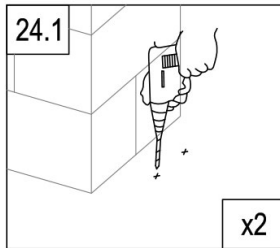
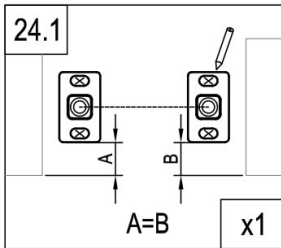
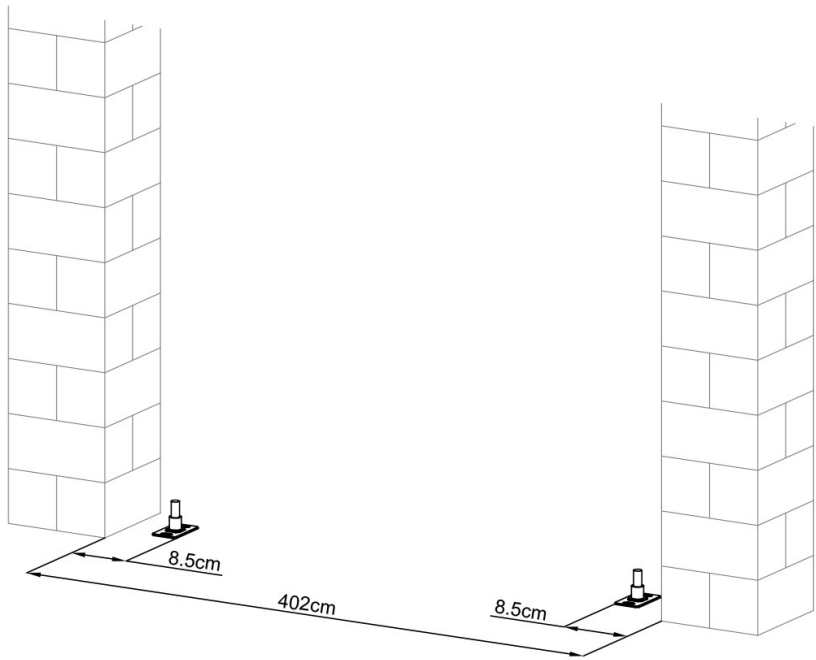

	Dr-23	1
	Dr-26	3



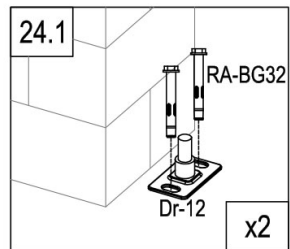

	Dr-12	2
	RA-BG32	4



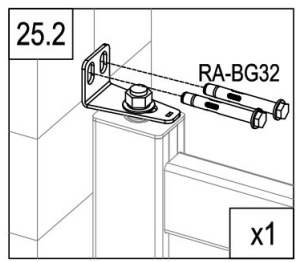
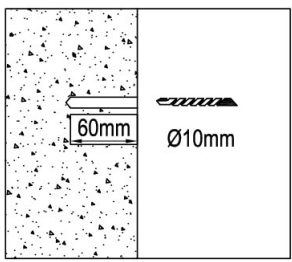
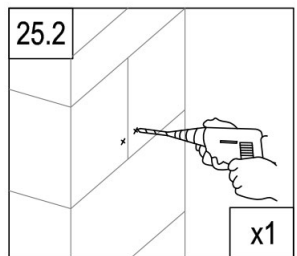
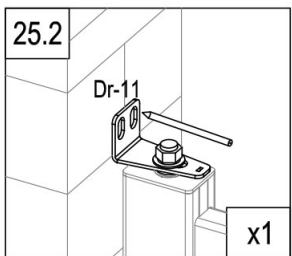
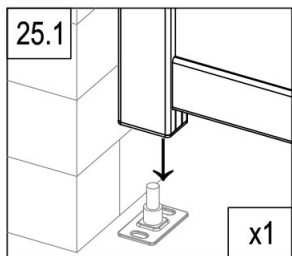
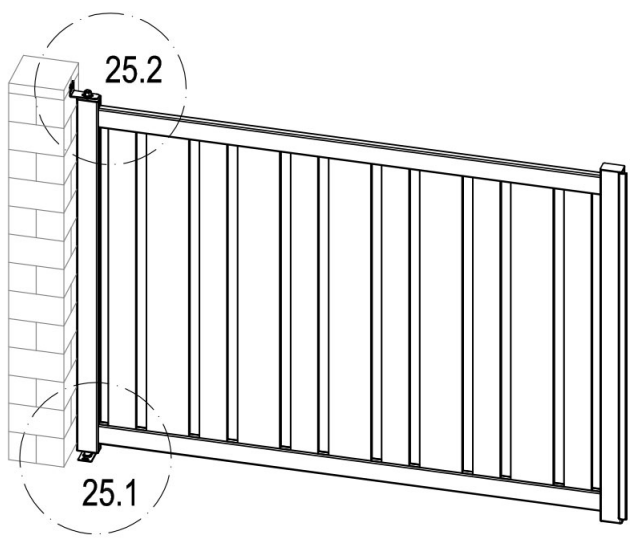

CASANOVO



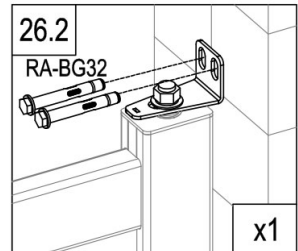
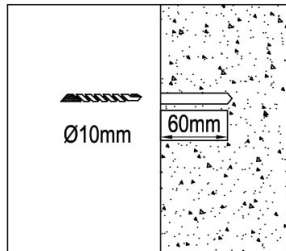
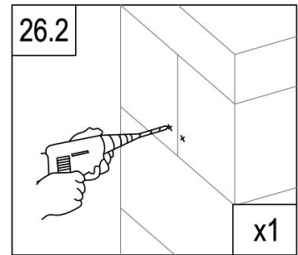
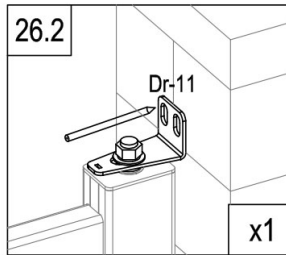
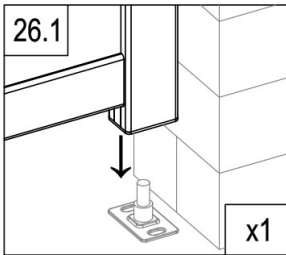
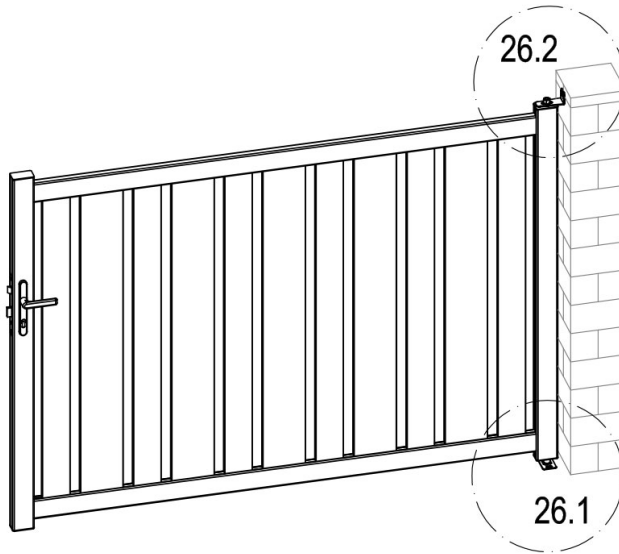

	Dr-11	1
	RA-BG32	2



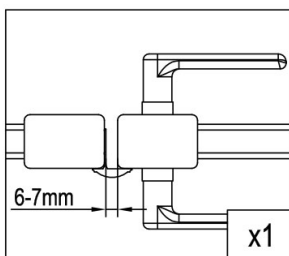
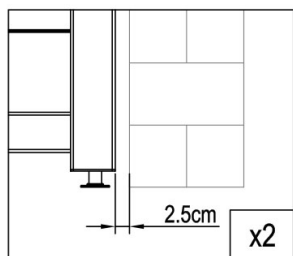
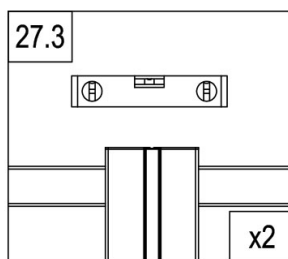
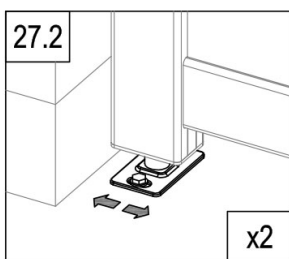
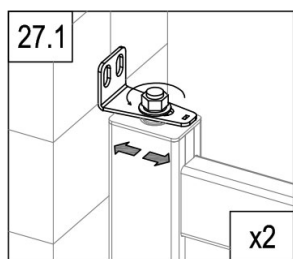
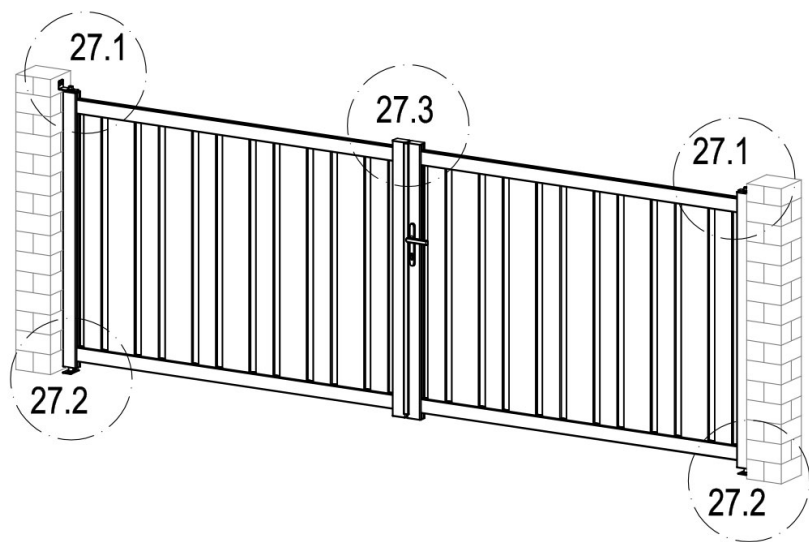

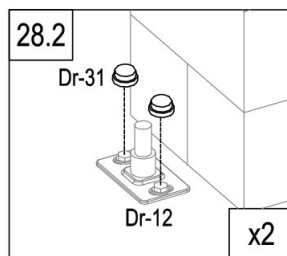
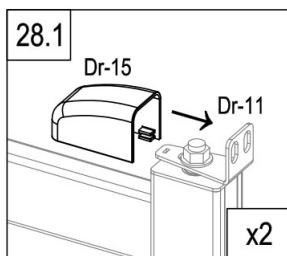
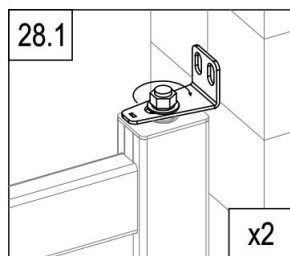
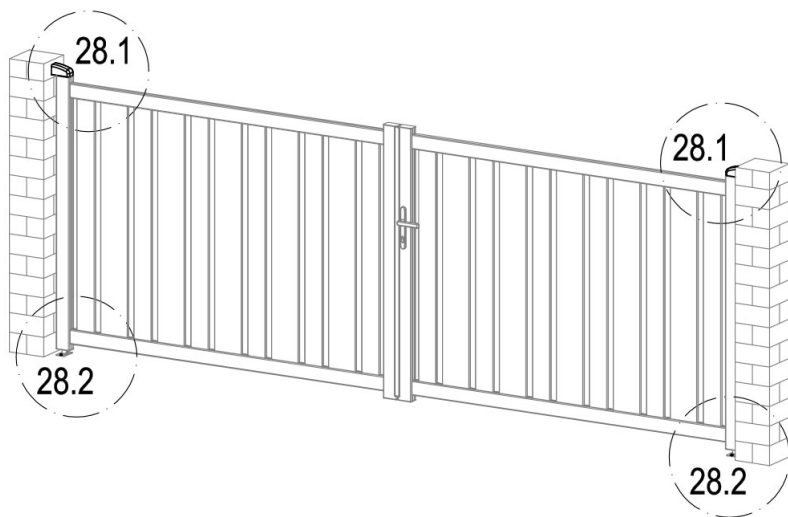

	Dr-11	1
	RA-BG32	2



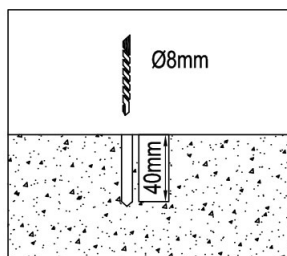
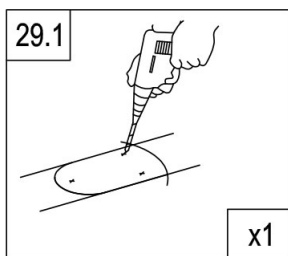
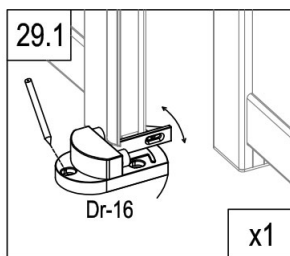
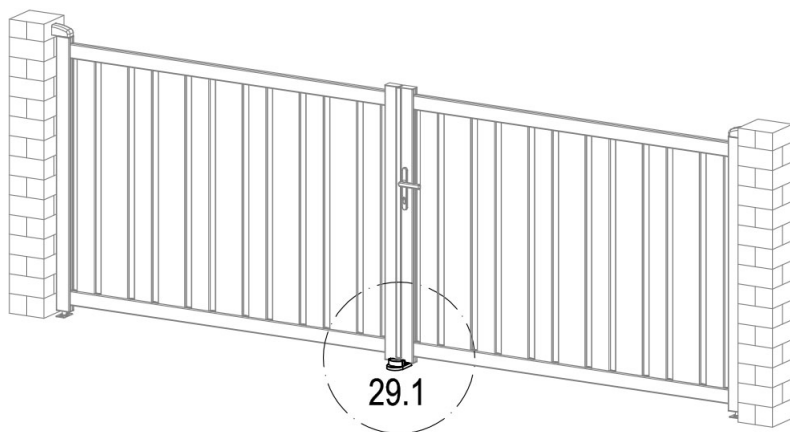



	Dr-15	2
	Dr-31	4

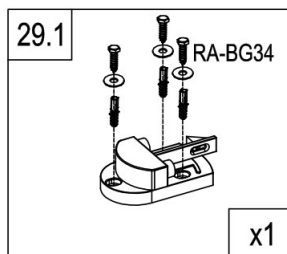

	Dr-16	1
	RA-BG34	3
	RA-BG35	3

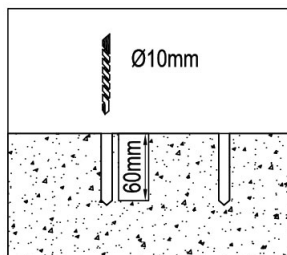
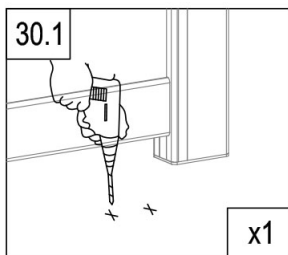
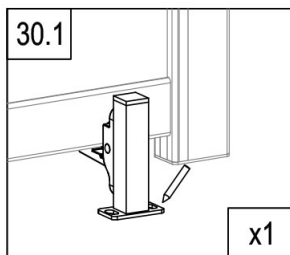
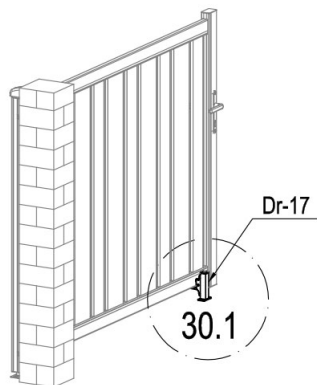
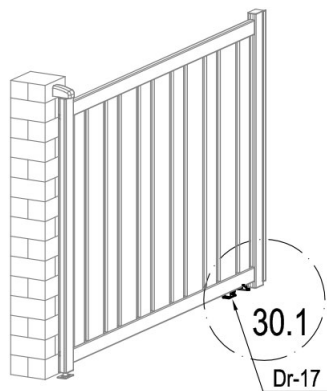



	RA-BG32	4
	Dr-17	2

