

CASANOVO

VEYMONT 300B160

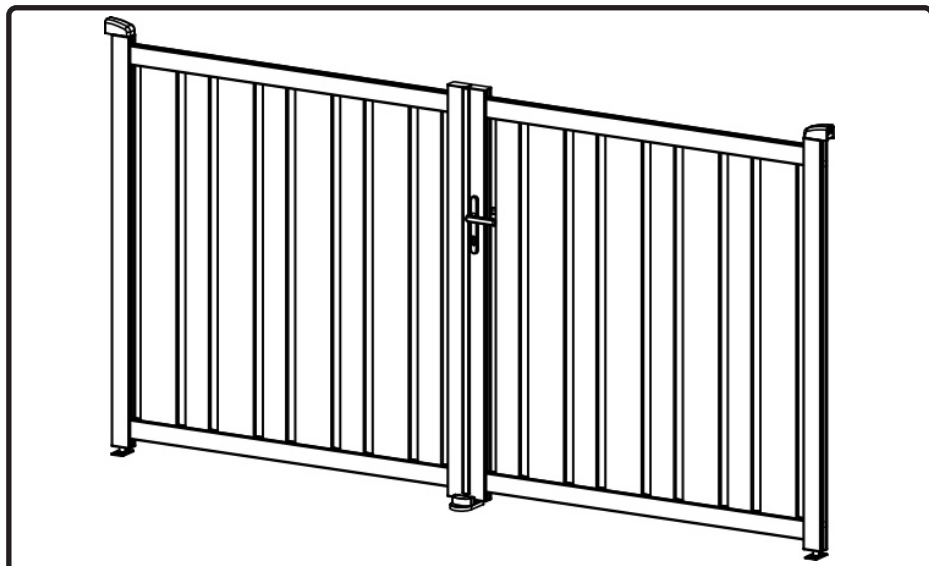

COM-000824 [x1]

COM-000825 [x1]



EN FR DE ES PT IT NL PL FI SE DK
RO SI SK HU CZ HR GR LT LV





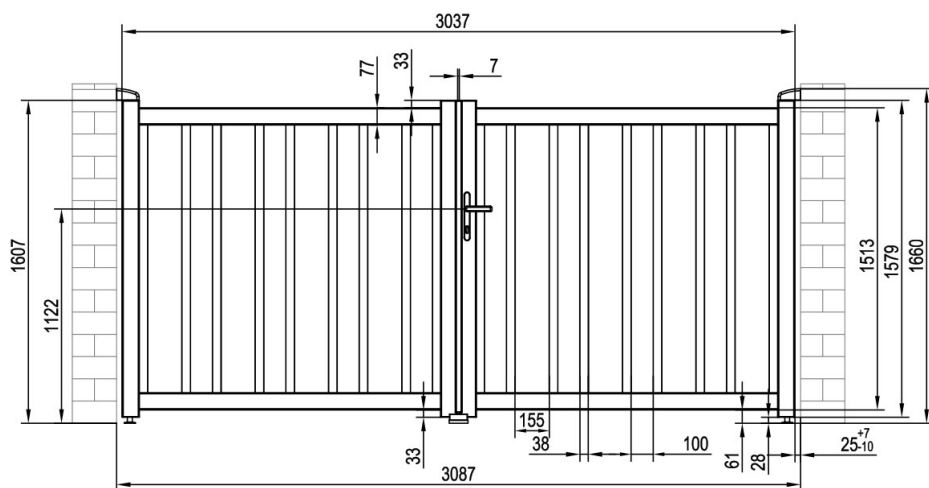

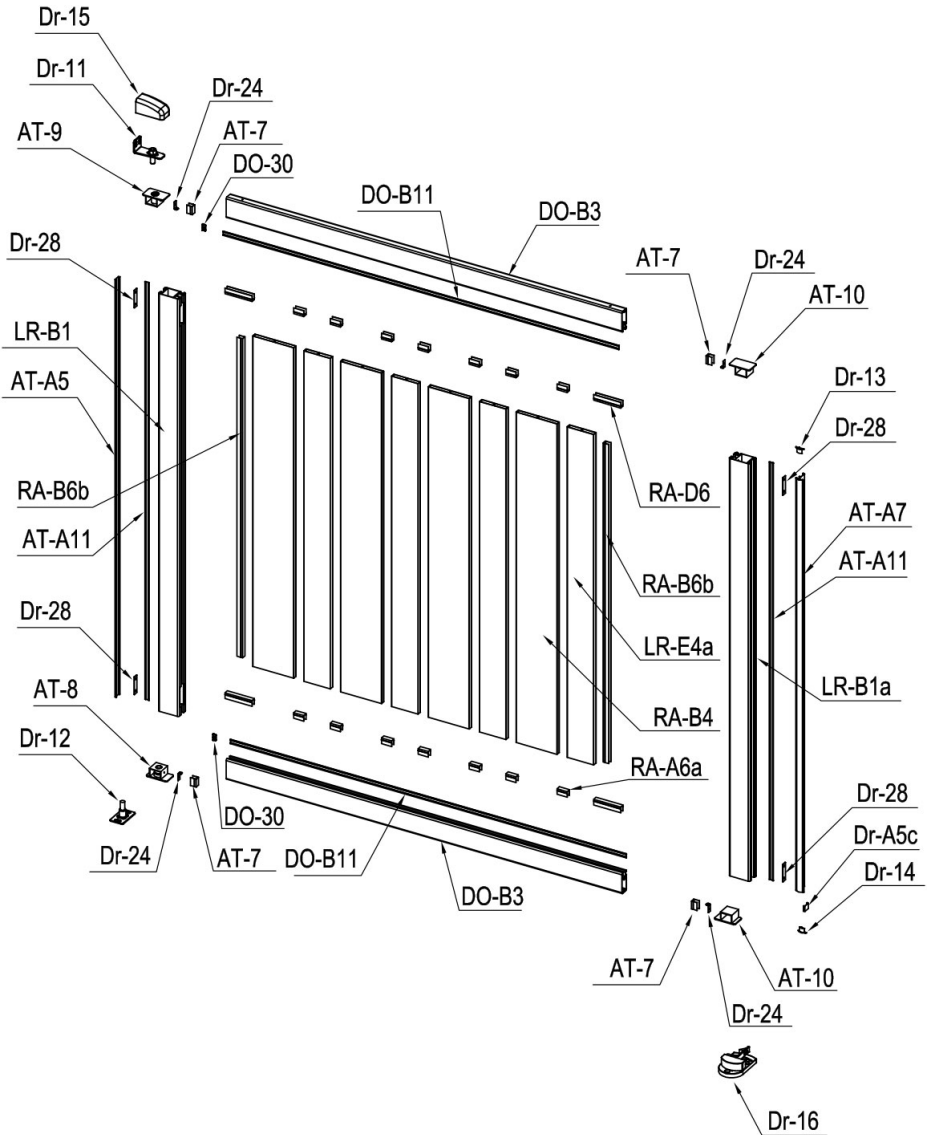

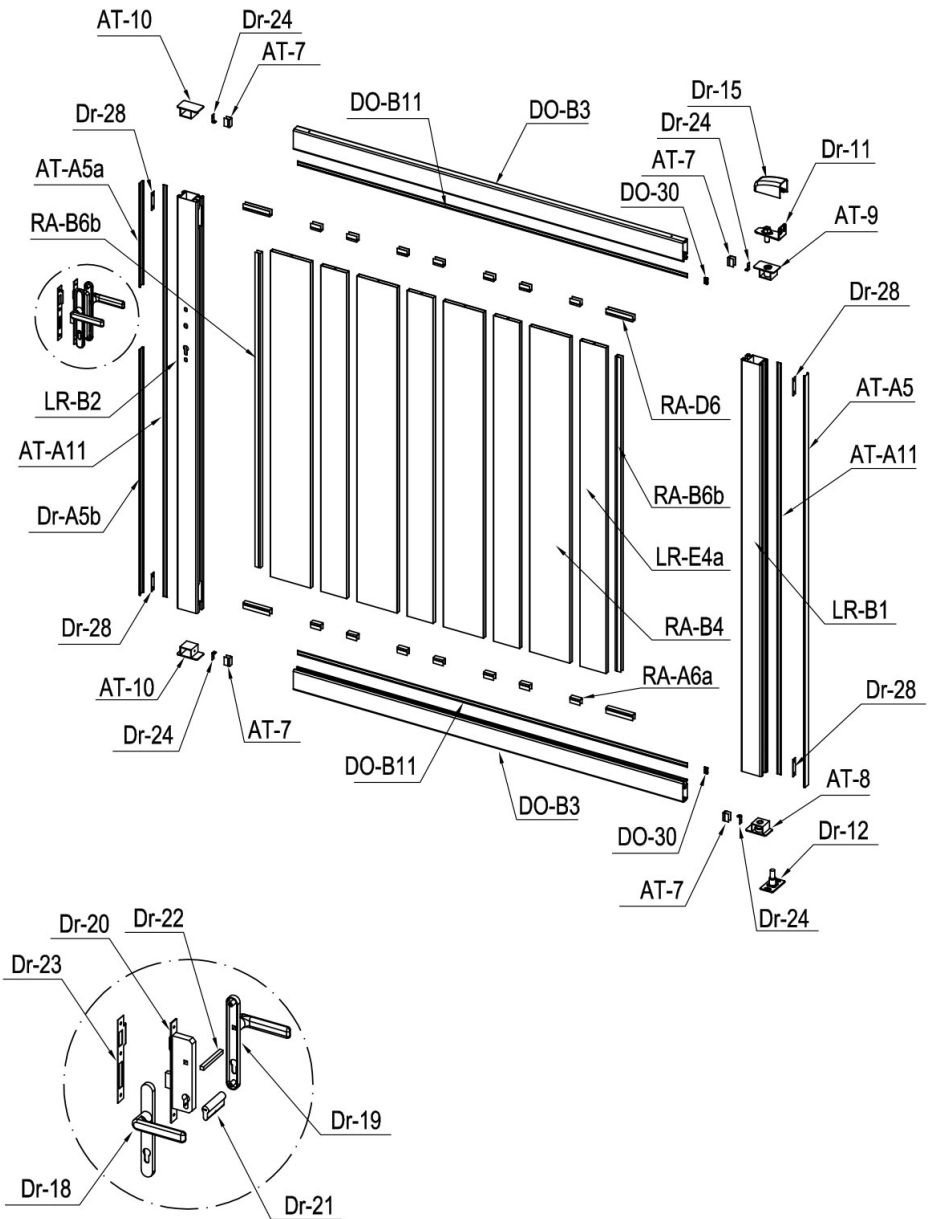































INSTRUCTION MANUAL / NOTICE DE MONTAGE / MONTAGEANLEITUNG / MANUAL DE MONTAJE / MANUAL DE MONTAGEM / MANUALE DI MONTAGGIO /
MONTAGEHANDLEIDING / INSTRUKCJA MONTAŻU / KÄYTTÖOHJEET / BRUKSANVISNING / BRUGSANVISNING / INSTRUCIUNI DE ASAMBLARE /
NAVODILA ZA SESTAVLJANJE / NÁVOD NA MONTÁŽ / ÖSSZESZERELÉSI ÚTMUTATÓ / NÁVOD K MONTÁŽI / UPUTE ZA INSTALACIJU /
ΟΔΗΓΙΕΣ ΣΥΝΑΡΜΟΛΟΓΗΣΗΣ / SURINKIMO INSTRUKCIJOS / MONTĀŽAS INSTRUKCIJAS











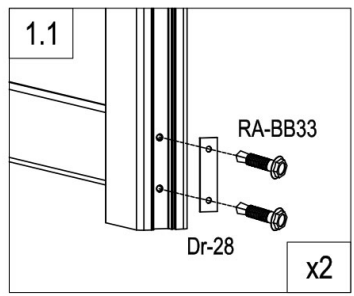
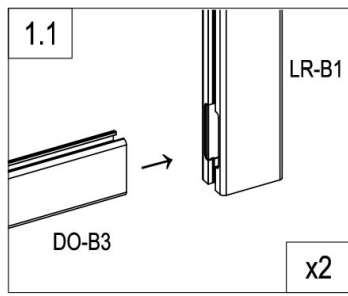
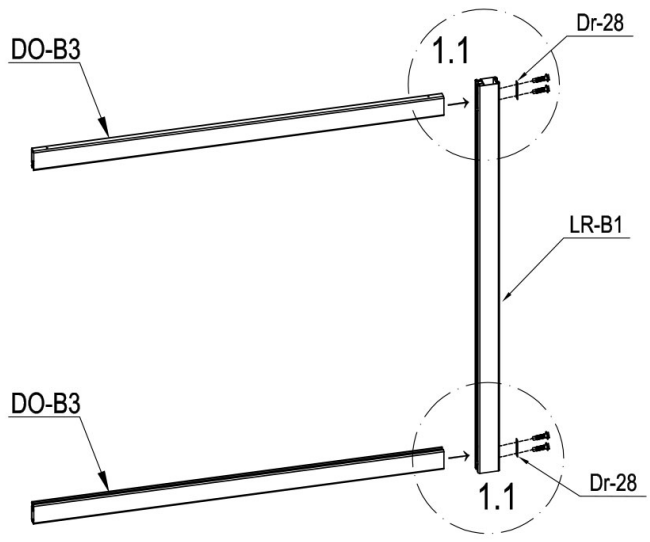

PART LIST

IMAGE	NO.	L.(mm)	QTY	IMAGE	NO.	L.(mm)	QTY
	LR-B1	1573	2		Dr-16		1
	LR-B1a	1573	1		Dr-17		2
	LR-B2	1573	1		Dr-31		4
	DO-B3	1492	4		DO-30		4
	RA-B4	1400	8		Dr-18		1
	LR-E4a	1400	8		Dr-19		1
	AT-A5	1573	2		Dr-20		1
	AT-A5a	395.5	1		Dr-21		1
	Dr-A5b	937	1		Dr-22		1
	Dr-A5c	19.5	1		Dr-23		1
	AT-A11	1573	4		Dr-25	M5x45	1
	DO-B11	1492	4		Dr-25a	M5x60	2
	AT-7	29.5	8		Dr-26	ST4x12	3
	RA-A6a	38	28		Dr-27	ST4.2x25	2
	RA-B6b	1357	4		Dr-24		8
	RA-D6	102	8		Dr-28		8
	AT-A7	1553	1		RA-BB30	ST4x10	8
	AT-8		2		RA-BB31	ST4.2x13	56
	AT-9		2		RA-BB32	M8x60	12
	AT-10		4		RA-BB33	ST5.5x38	16
	Dr-11		2		RA-BB34	ST6x40	3
	Dr-12		2		RA-BB35	Ø6	3
	Dr-13		1		RA-BB36	ST4.8x38	8
	Dr-14		1				
	Dr-15		2				



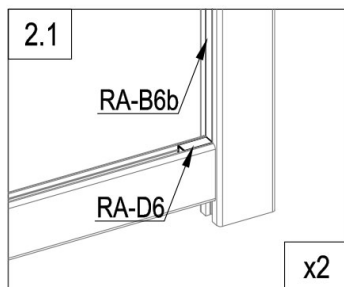
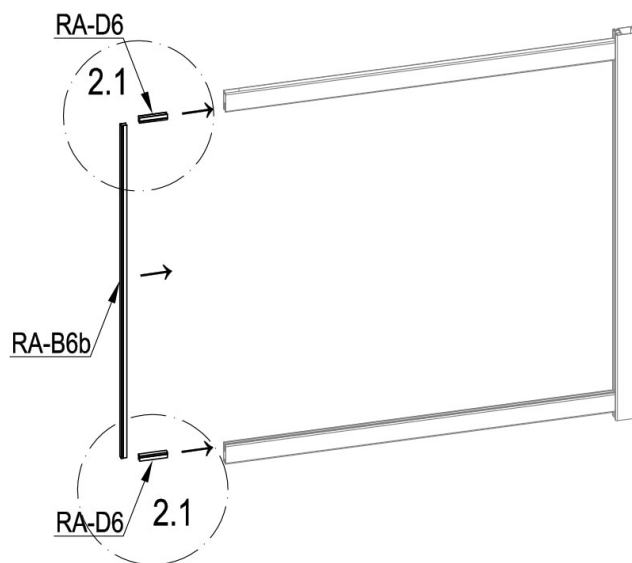

	LR-B1	1
	DO-B3	2
	Dr-28	2
	RA-BB33	4

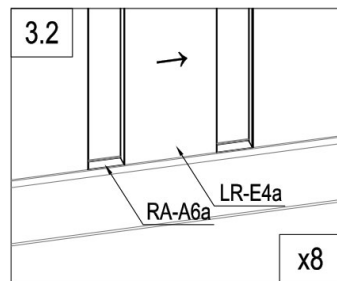
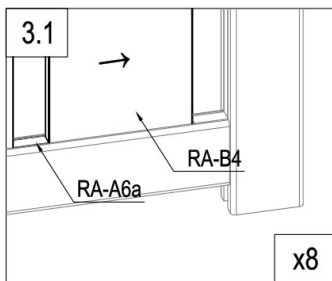
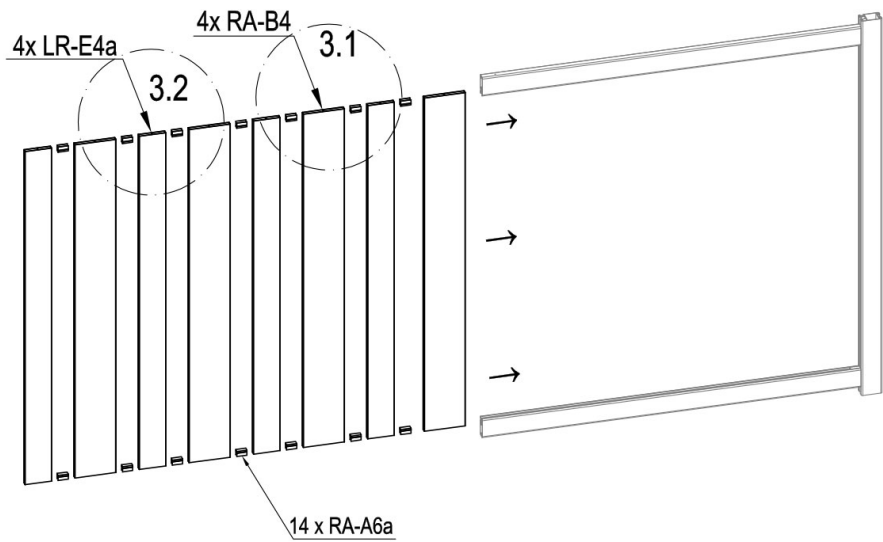

	RA-D6	2
	RA-B6b	1





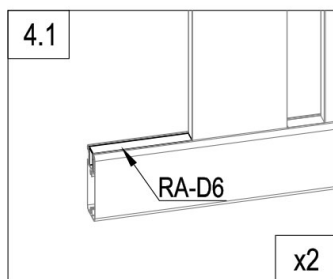
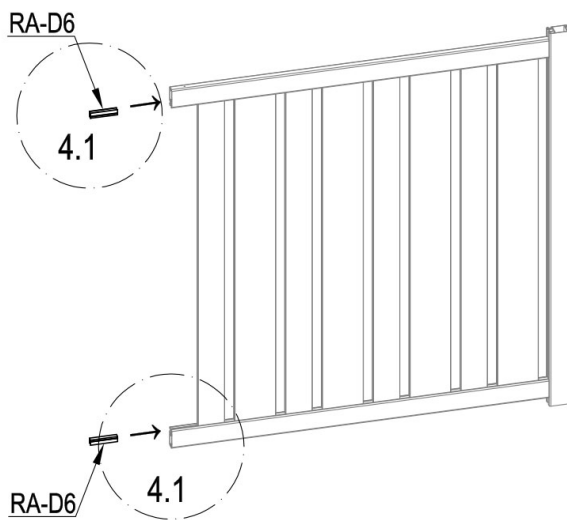

	RA-B4	4
	LR-E4a	4
	RA-A6a	14

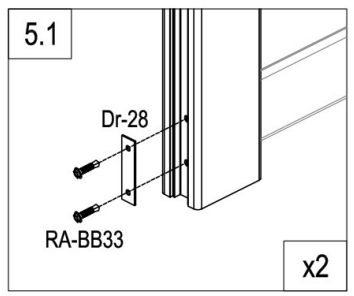
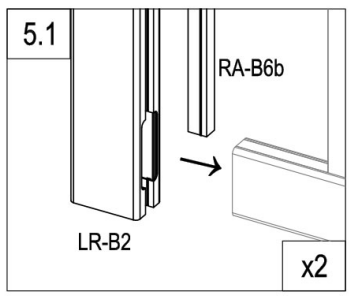
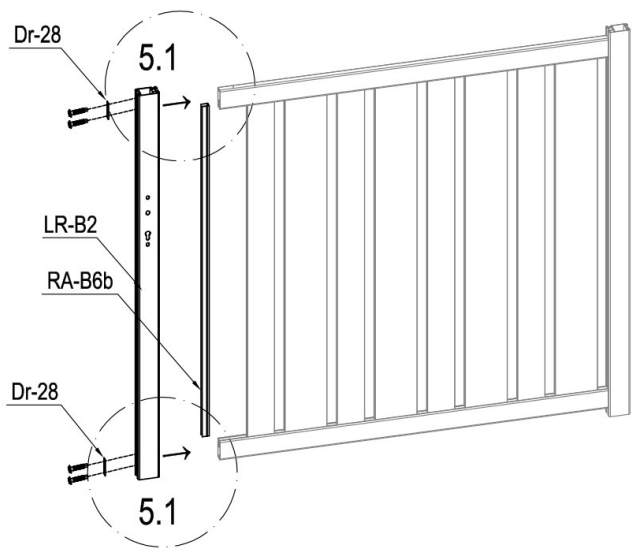

	RA-D6	2
---	-------	---



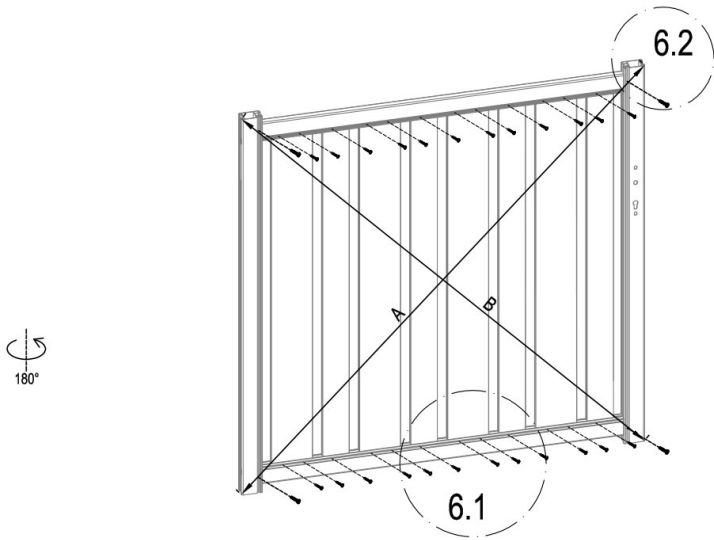

	LR-B2	1
	RA-B6b	1
	Dr-28	2
	RA-BB33	4

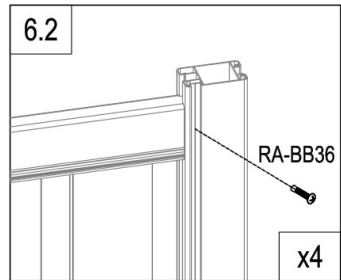
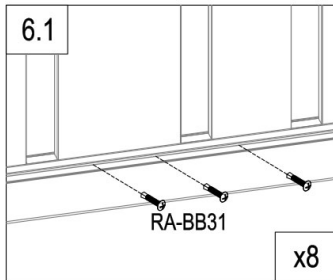

A=B



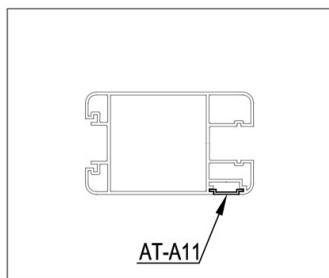
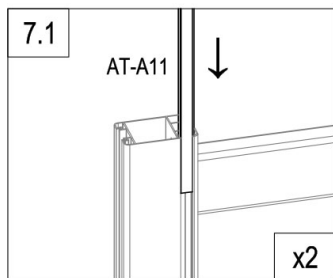
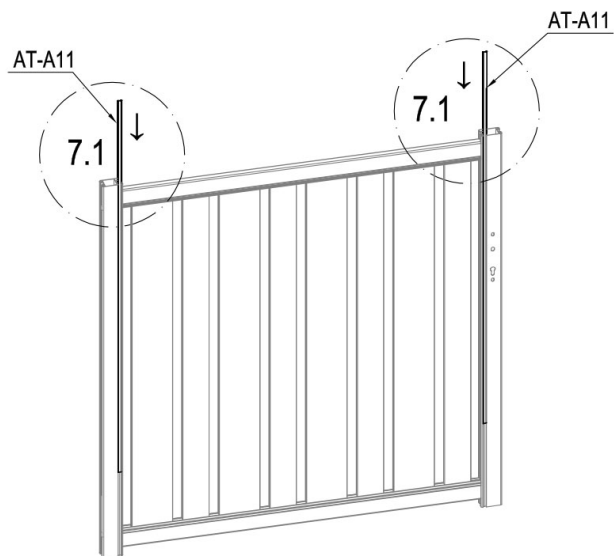

	RA-BB31	24
	RA-BB36	4

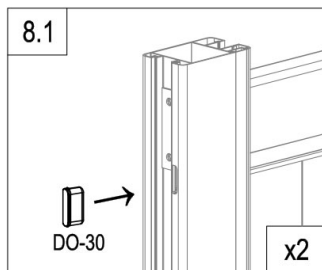
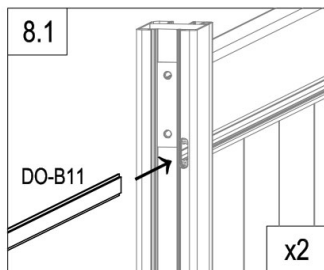
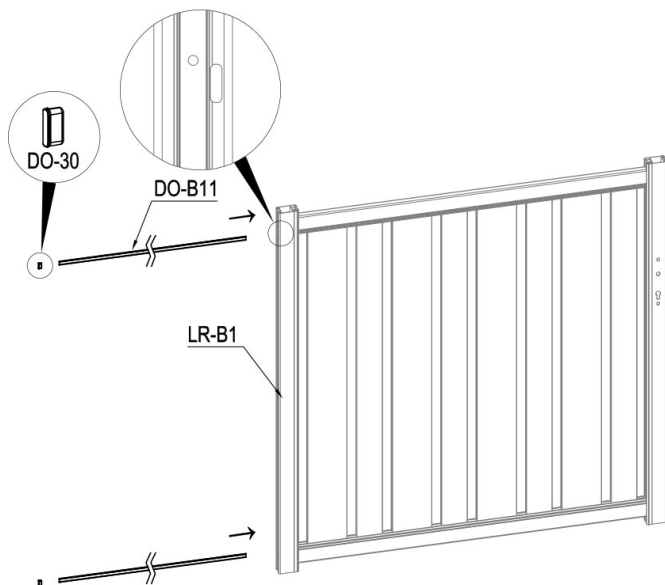

	AT-A11	2
---	--------	---



	DO-B11	2
	DO-30	2

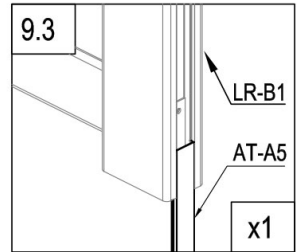
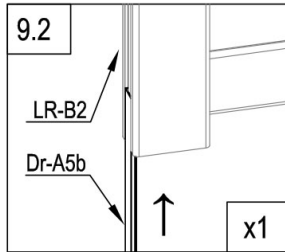
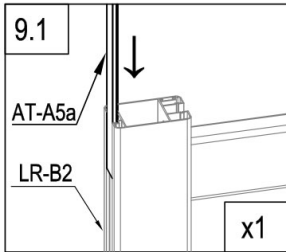
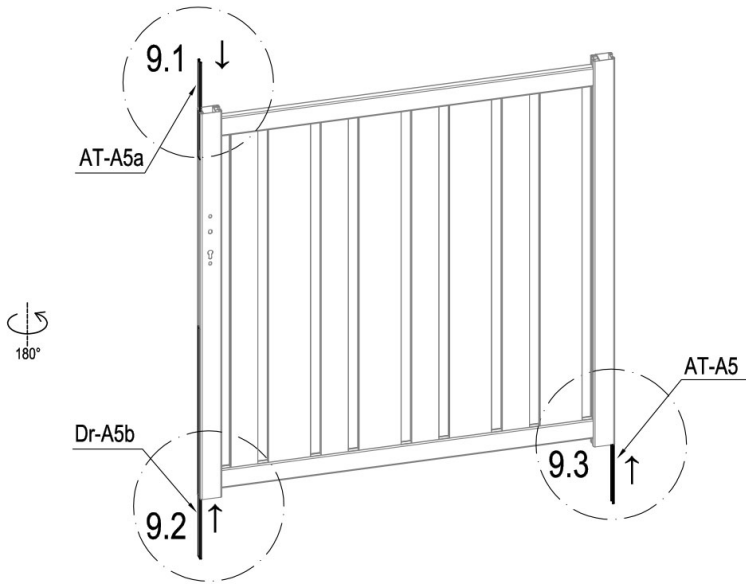

	AT-A5	1
	AT-A5a	1
	Dr-A5b	1

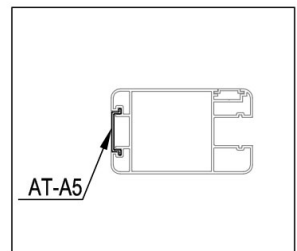

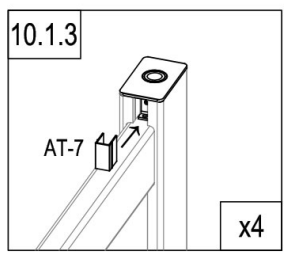
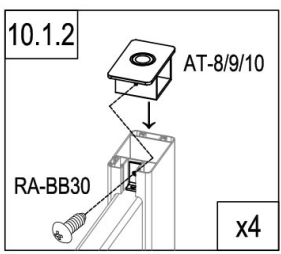
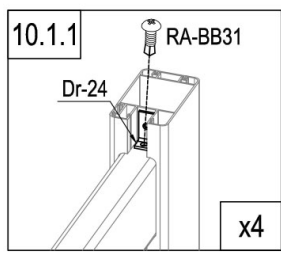
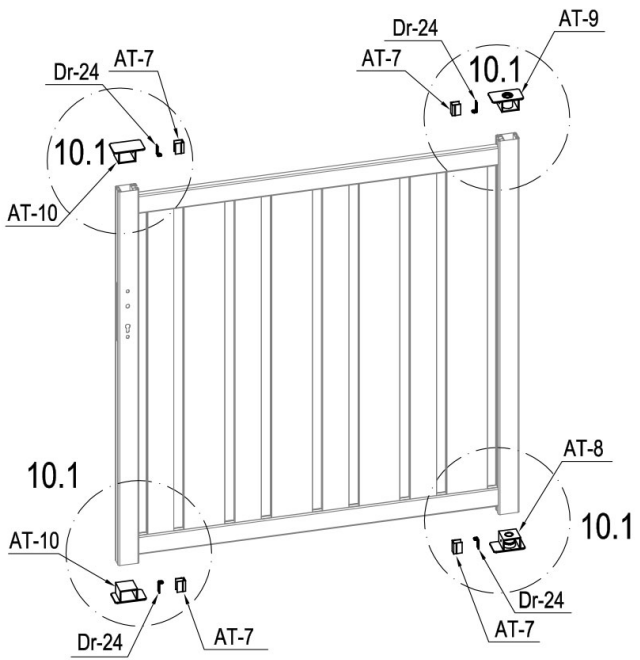

	AT-8	1
	AT-9	1
	AT-10	2
	Dr-24	4



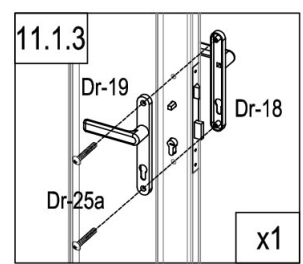
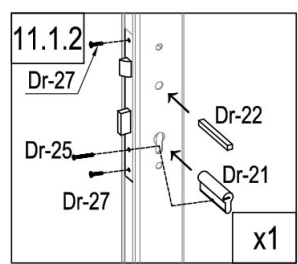
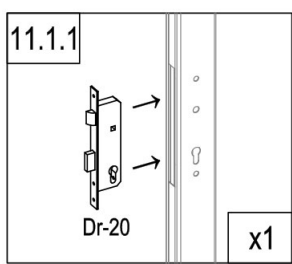
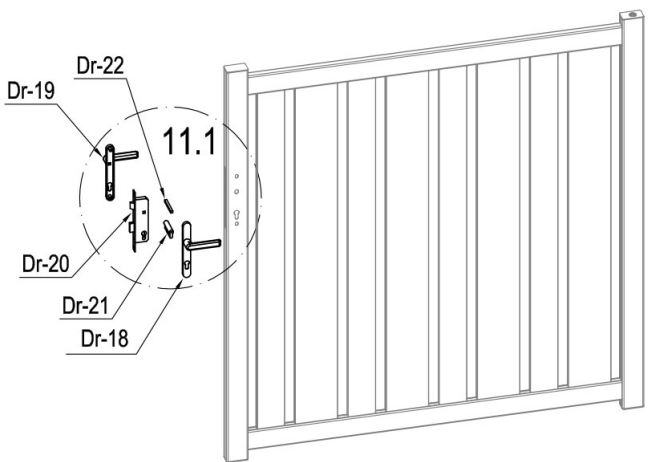

	AT-7	4
	RA-BB30	4
	RA-BB31	4



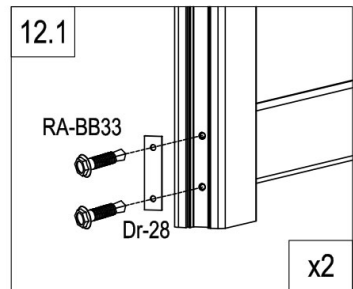
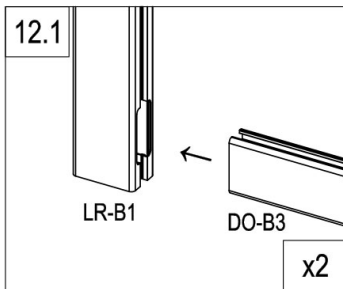
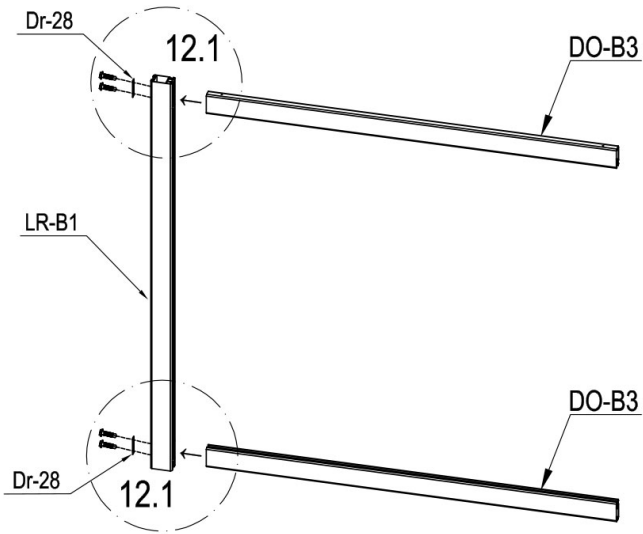

	Dr-20	1
	Dr-21	1
	Dr-22	1
	Dr-25	1

	Dr-18	1
	Dr-19	1
	Dr-25a	2
	Dr-27	2



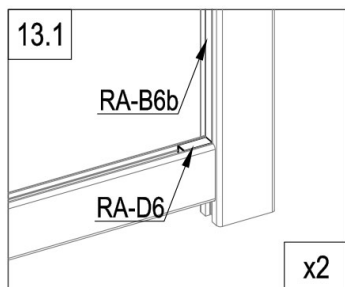
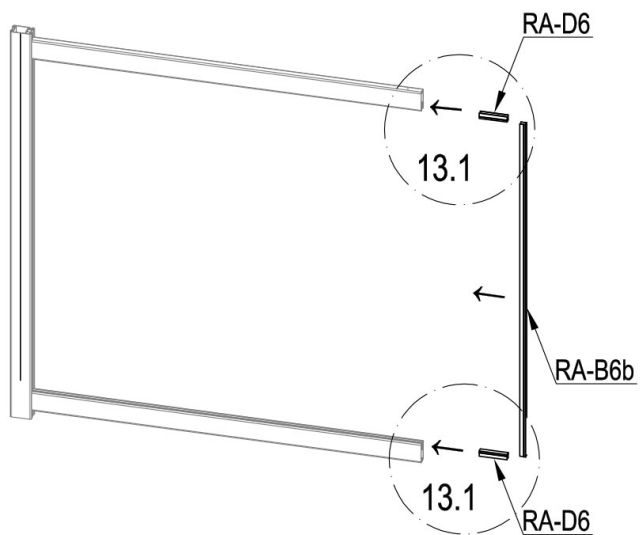

	LR-B1	1
	DO-B3	2
	Dr-28	2
	RA-BB33	4

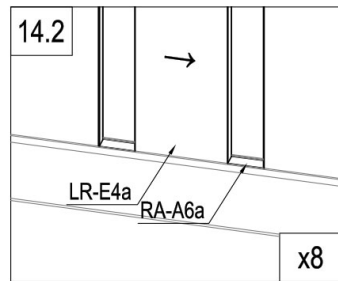
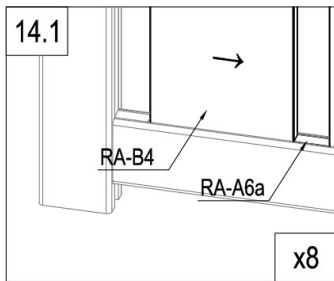
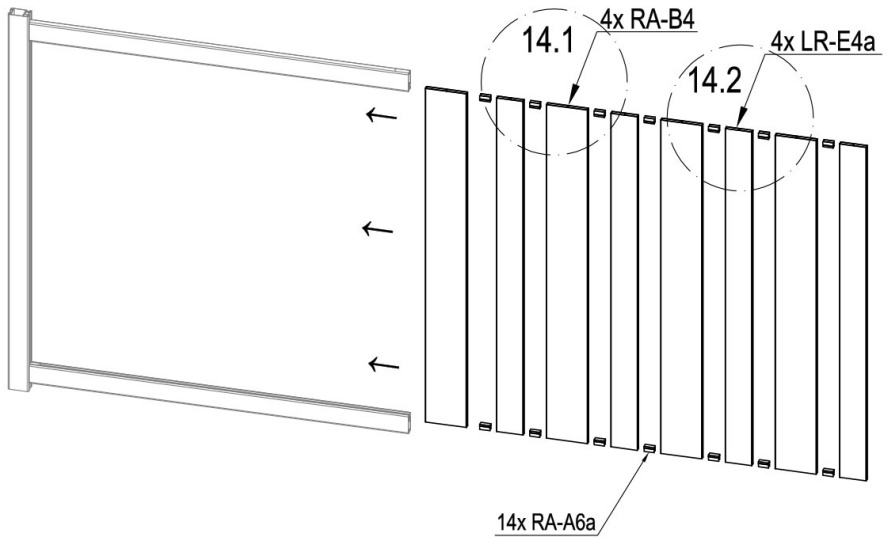

	RA-D6	2
	RA-B6b	1



	RA-B4	4
	LR-E4a	4
	RA-A6a	14

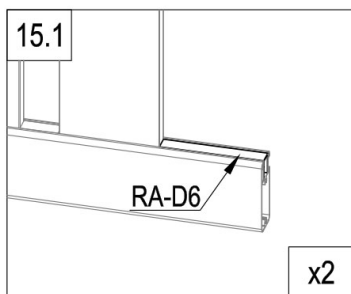
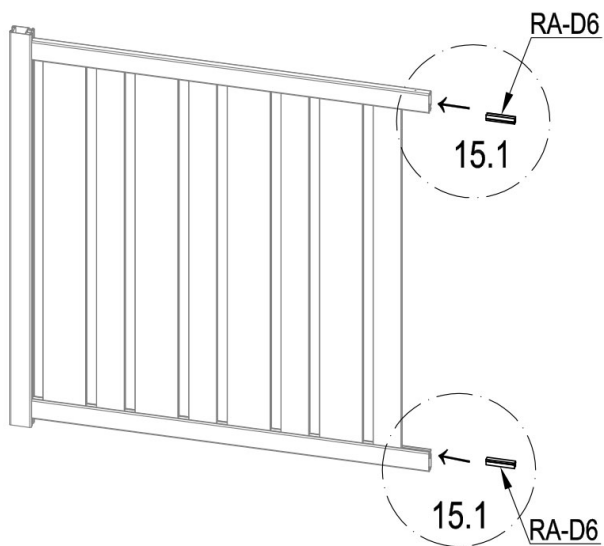

	RA-D6	2
---	-------	---

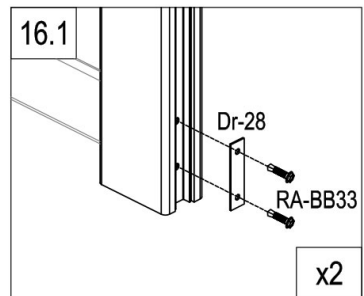
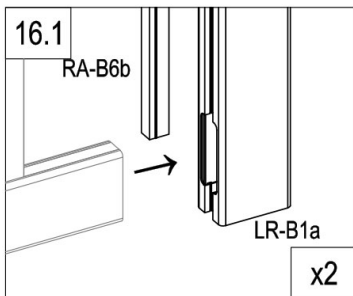
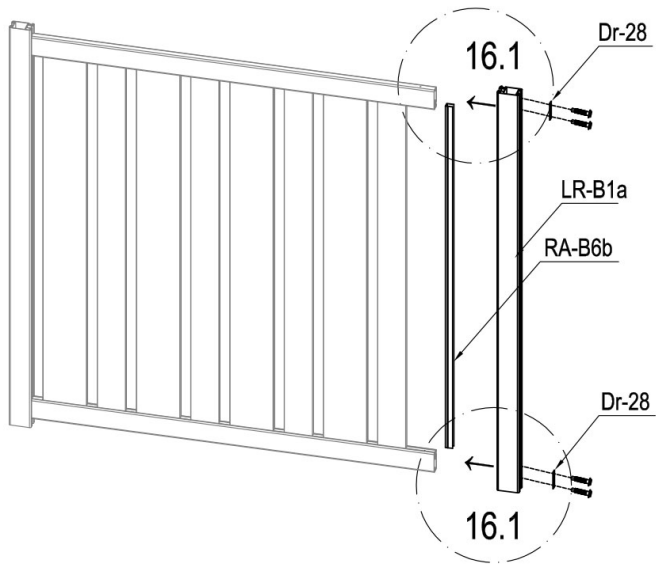

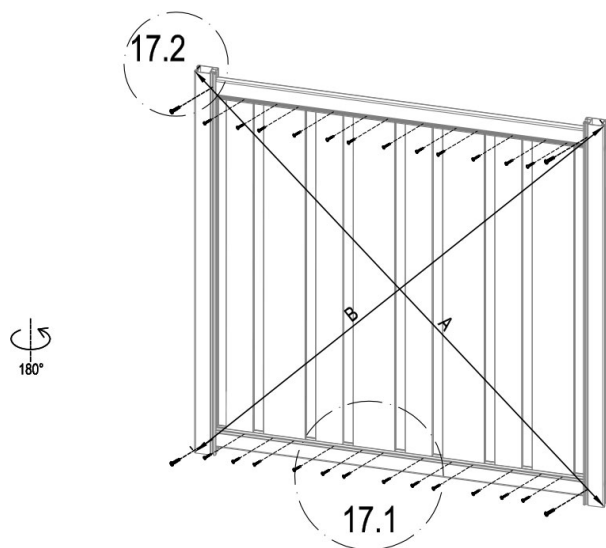

	LR-B1a	1
	RA-B6b	1
	Dr-28	2
	RA-BB33	4

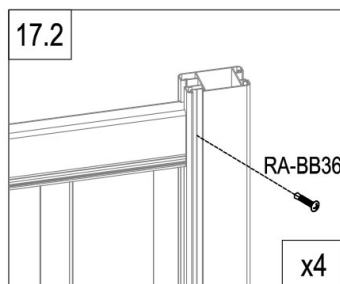
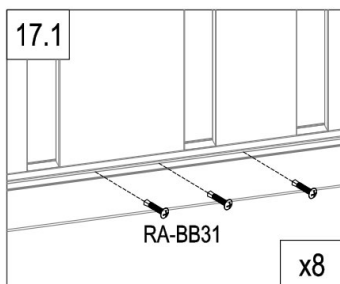

A=B



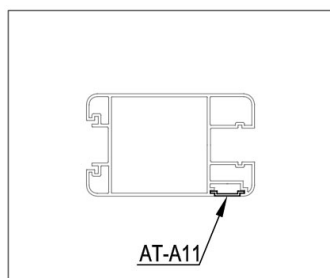
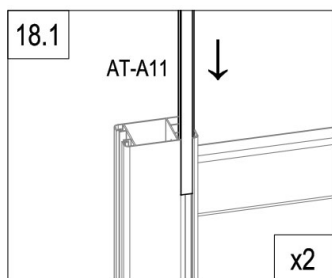
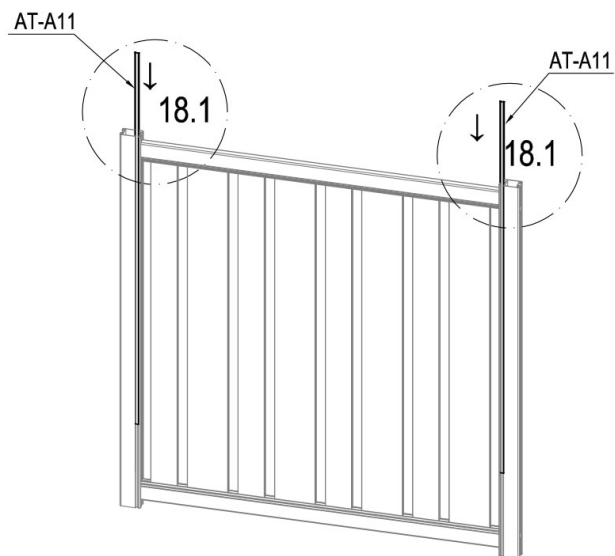

	RA-BB31	24
	RA-BB36	4



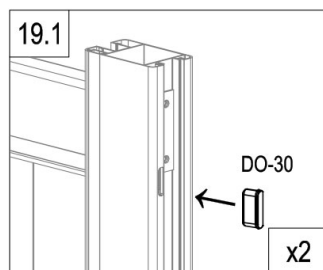
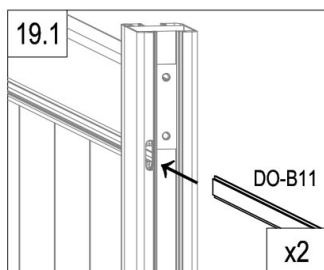
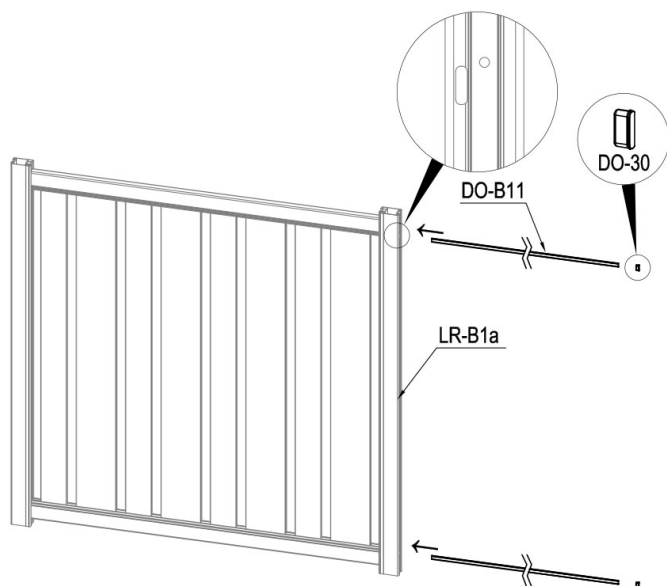

	AT-A11	2
---	--------	---

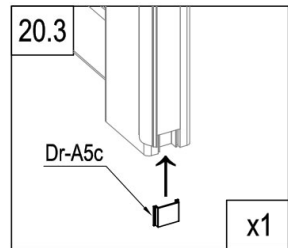
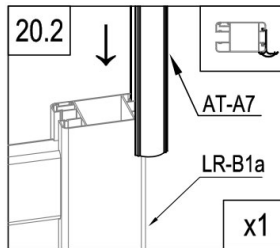
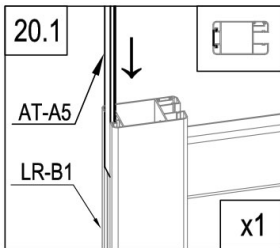
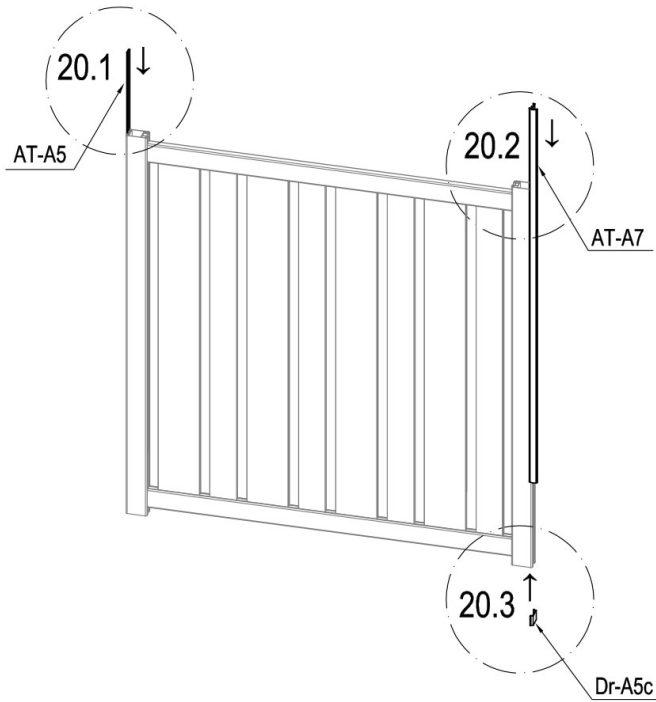

	DO-B11	2
	DO-30	2



	AT-A5	1
	Dr-A5c	1
	AT-A7	1

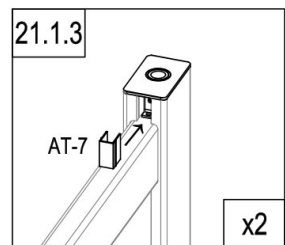
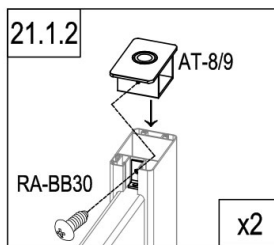
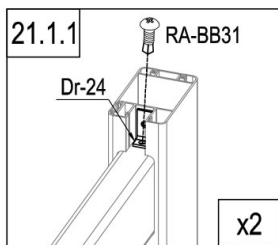
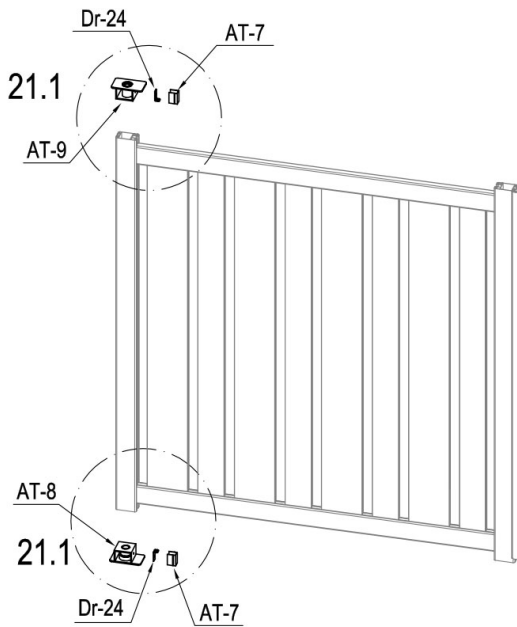

	AT-8	1
	AT-9	1
	Dr-24	2

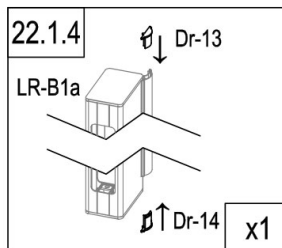
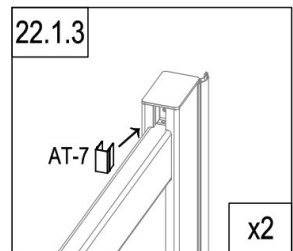
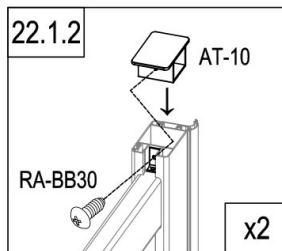
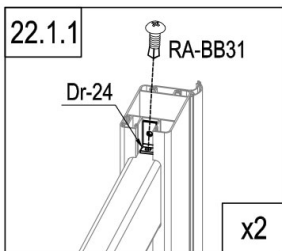
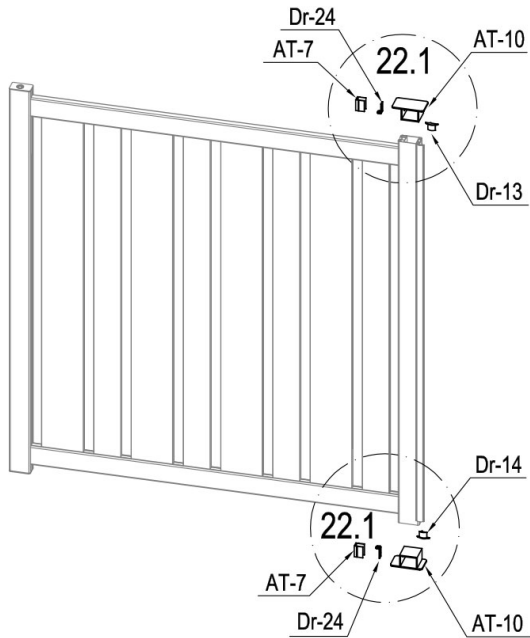

	AT-7	2
	RA-BB30	2
	RA-BB31	2



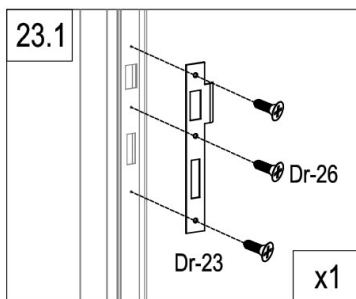
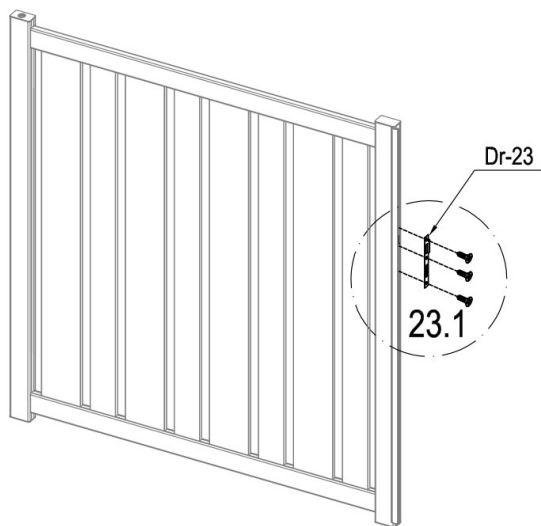

	AT-10	2
	Dr-24	2
	AT-7	2
	Dr-13	1

	Dr-14	1
	RA-BB30	2
	RA-BB31	2



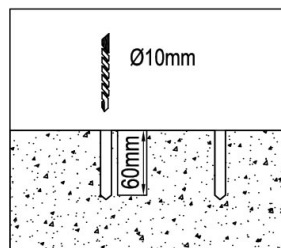
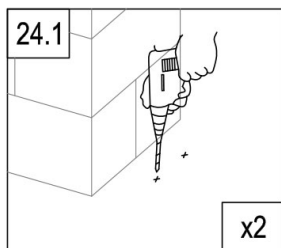
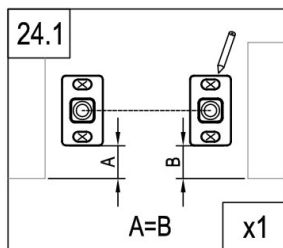
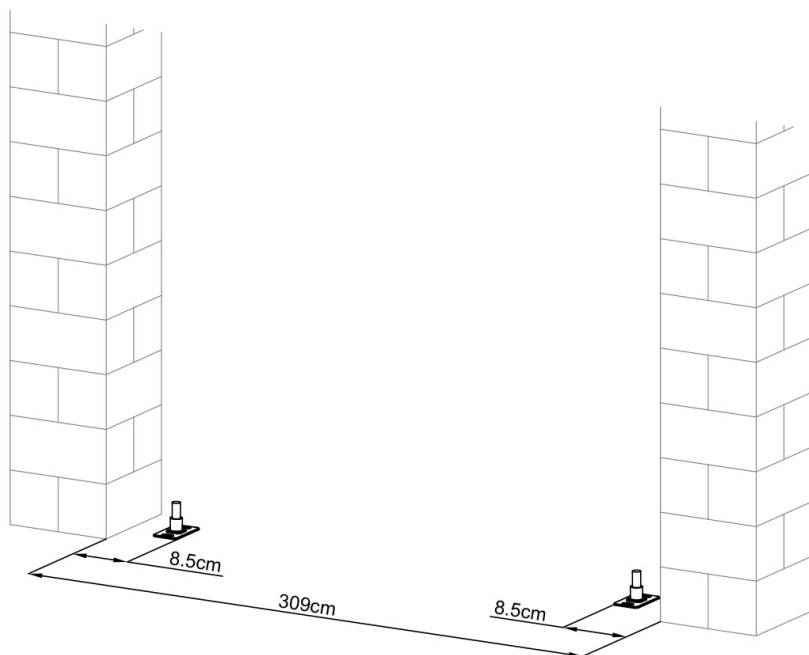

	Dr-23	1
	Dr-26	3



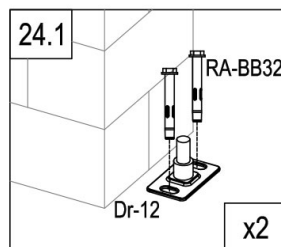

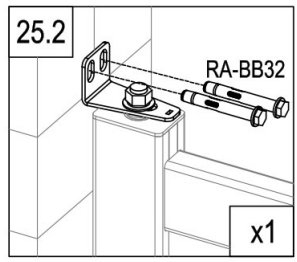
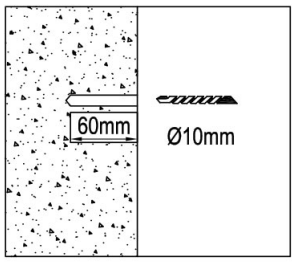
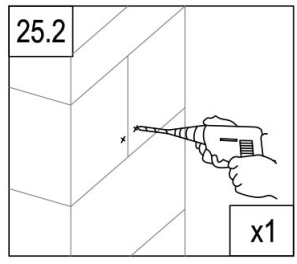
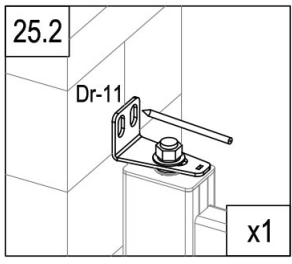
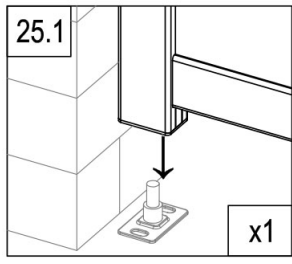
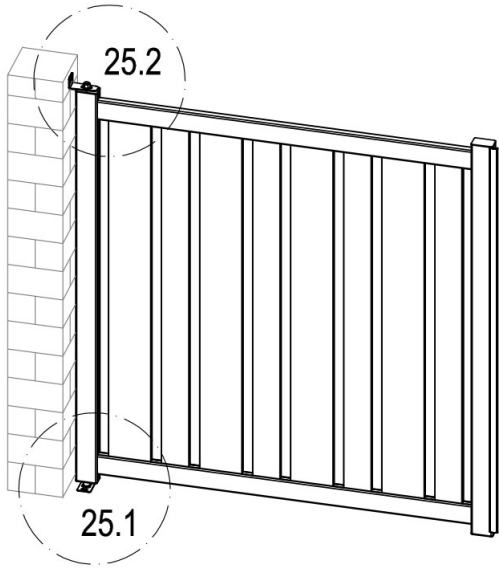
	Dr-12	2
	RA-BB32	4





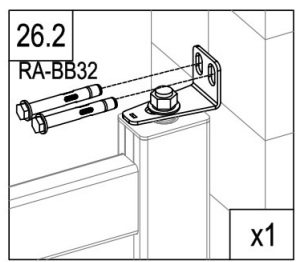
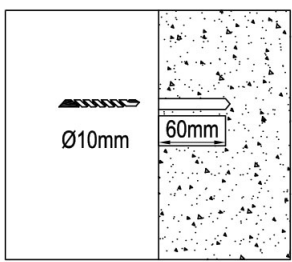
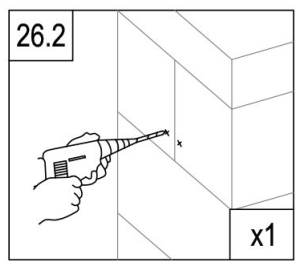
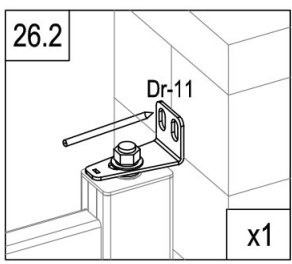
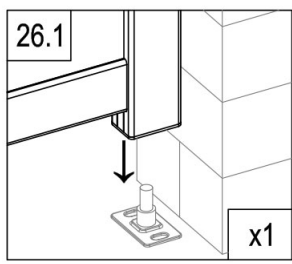
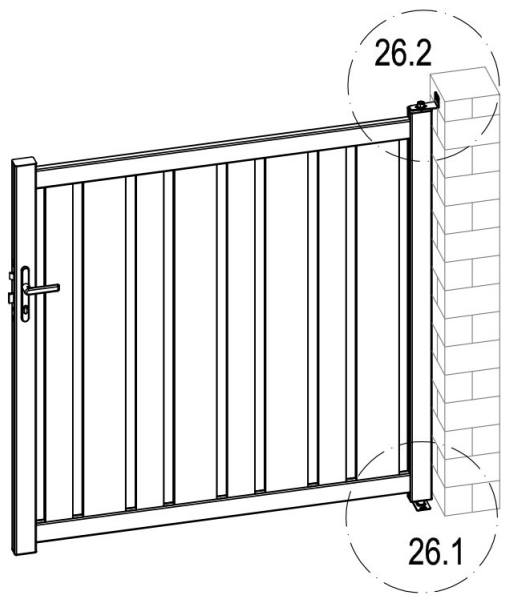

	Dr-11	1
	RA-BB32	2



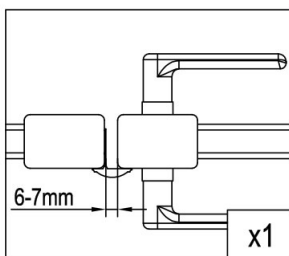
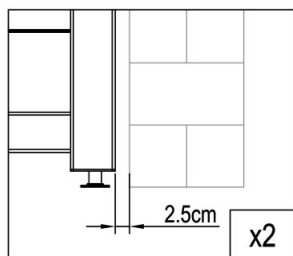
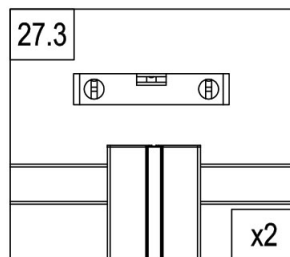
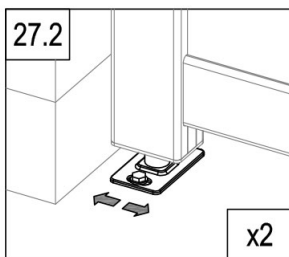
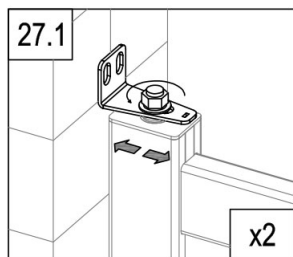
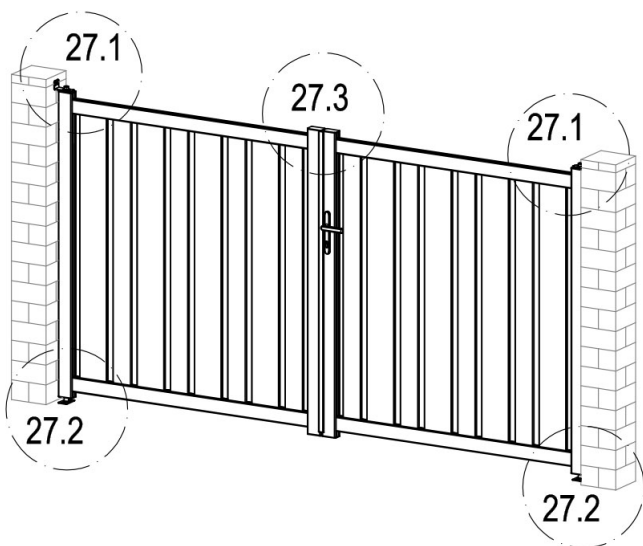

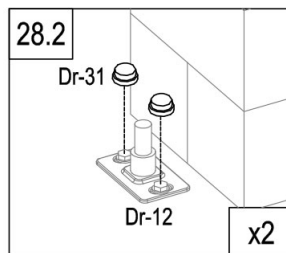
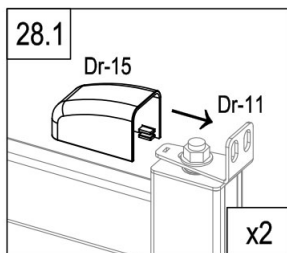
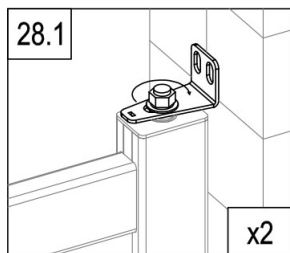
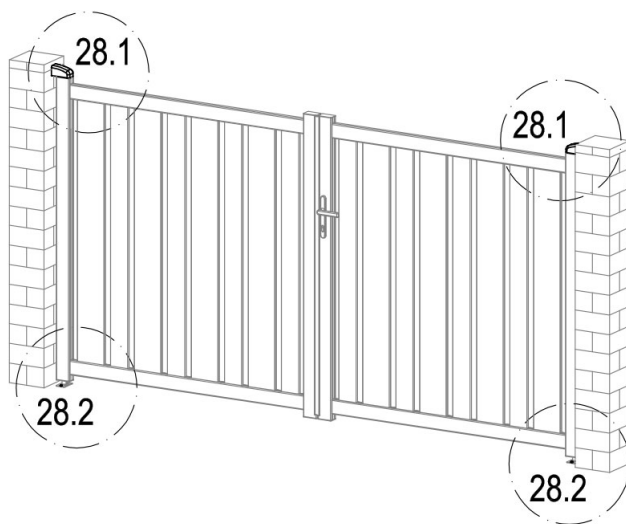

	Dr-11	1
	RA-BB32	2



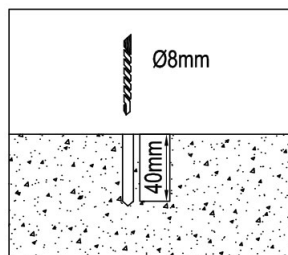
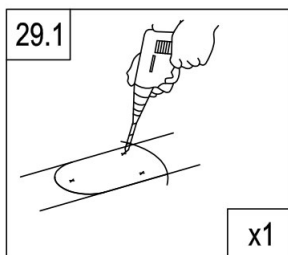
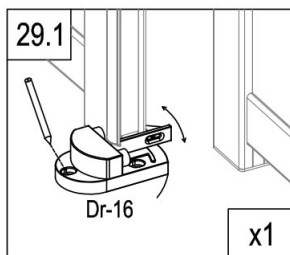
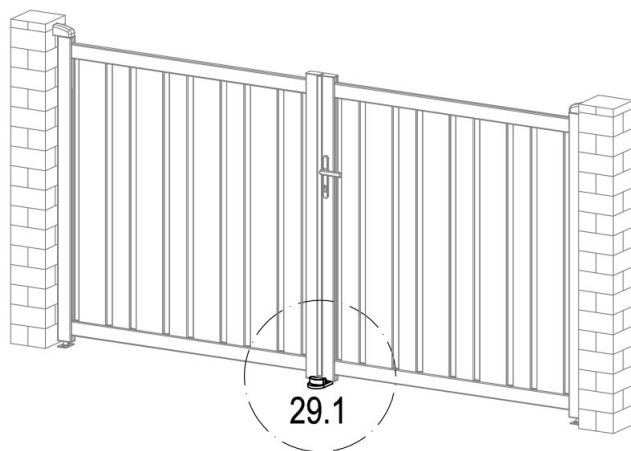



	Dr-15	2
	Dr-31	4

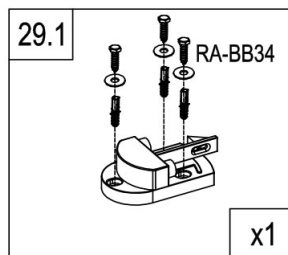

	Dr-16	1
	RA-BB34	3
	RA-BB35	3

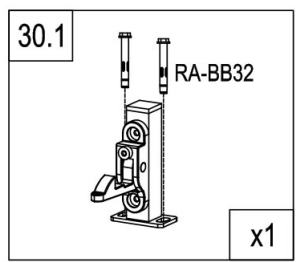
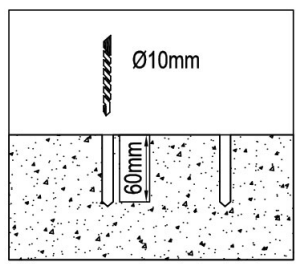
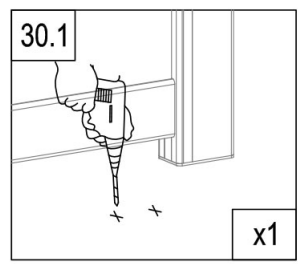
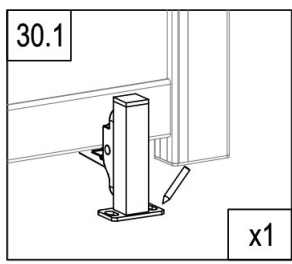
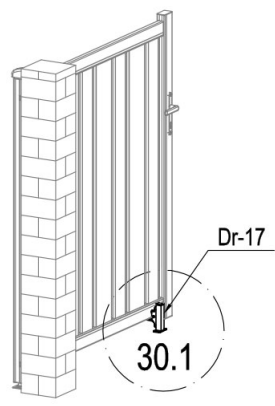
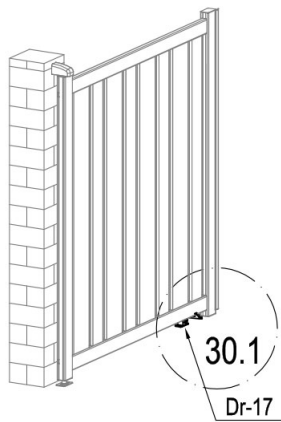



	RA-BB32	4
	Dr-17	2