

# CASANOVO

## MEIJE 300B140

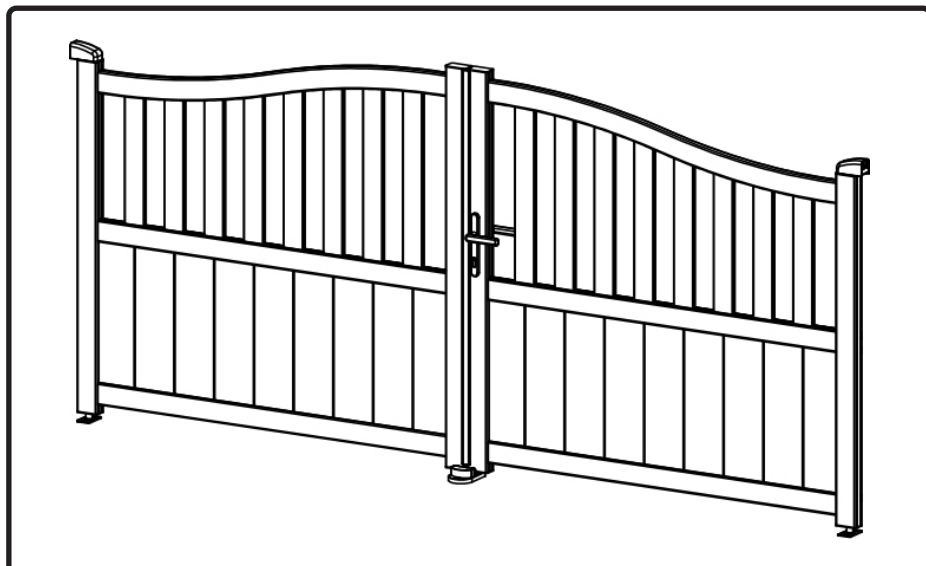

STI-000786 [x1]

STI-000787 [x1]



5-7H



X 2





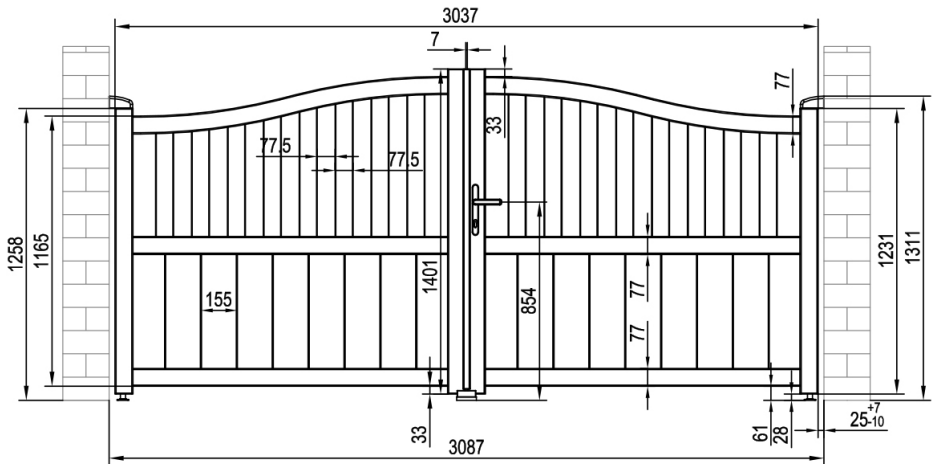

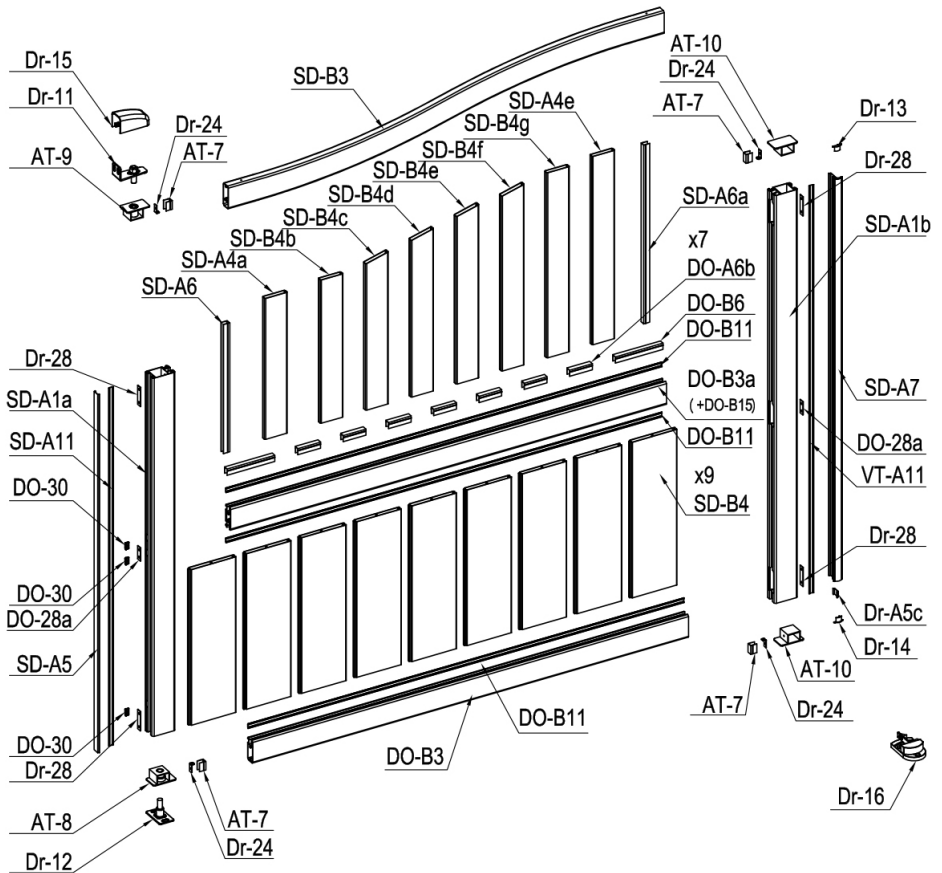

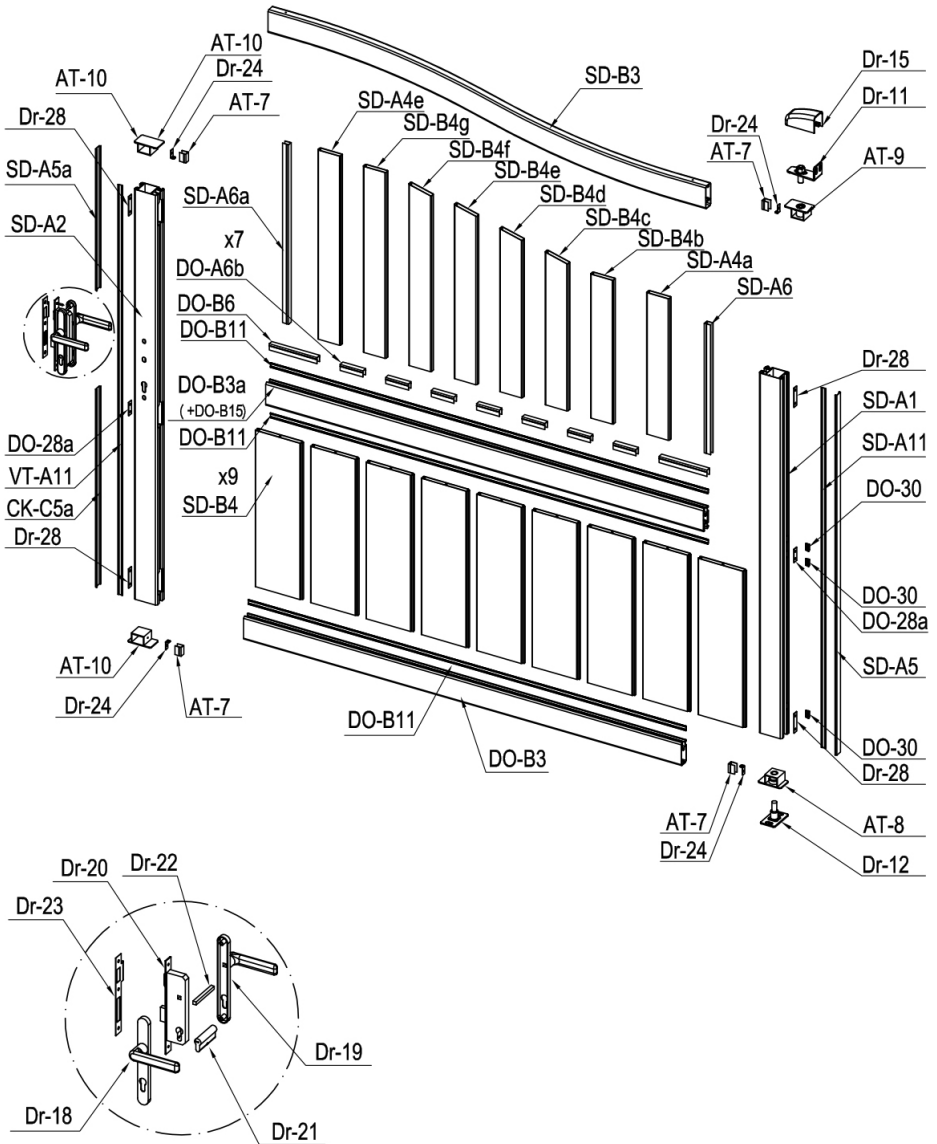



































INSTRUCTION MANUAL / NOTICE DE MONTAGE / MONTAGEANLEITUNG / MANUAL DE MONTAJE / MANUAL DE MONTAGEM / MANUALE DI MONTAGGIO /  
MONTAGEHANDLEIDING / INSTRUKCJA MONTAŻU / KÄYTTÖOHJEET / BRUKSANVISNING / BRUGSANVISNING / INSTRUCIUNI DE ASAMBLARE /  
NAVODILA ZA SESTAVLJANJE / NÁVOD NA MONTÁŽ / ÖSSZESZERELÉSI ÚTMUTATÓ / NÁVOD K MONTÁŽI / UPUTE ZA INSTALACIJU /  
ΟΔΗΓΙΕΣ ΣΥΝΑΡΜΟΛΟΓΗΣΗΣ / SURINKIMO INSTRUKCIJOS / MONTÁŽAS INSTRUKCIJAS







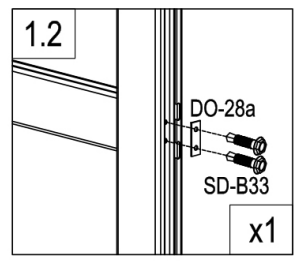
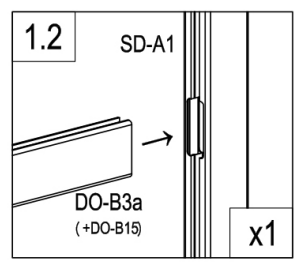
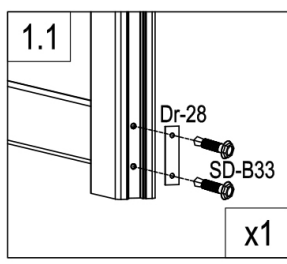
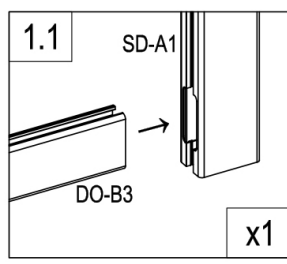
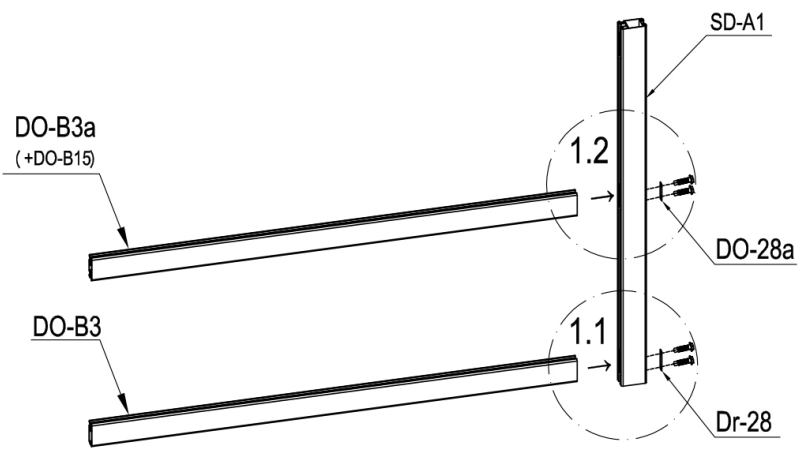

# CASANOVA

IMAGE	NO.	L.(mm)	QTY	IMAGE	NO.	L.(mm)	QTY
	SD-A1	1225	1		AT-9		2
	SD-A1a	1225	1		AT-10		4
	SD-A1b	1395	1		Dr-11		2
	DO-A2	1395	1		Dr-12		2
	DO-B3	1492	2		Dr-13		1
	DO-B3a (+DO-B15)	1492	2		Dr-14		1
	SD-B3	1492	2		Dr-15		2
	SD-B4	532	18		Dr-16		1
	SD-A4a	482	2		Dr-17		2
	SD-B4b	490	2		Dr-31		4
	SD-B4c	520	2		DO-30		6
	SD-B4d	555	2		Dr-18		1
	SD-B4e	592	2		Dr-19		1
	SD-B4f	617	2		Dr-20		1
	SD-B4g	633	2		Dr-21		1
	SD-A4e	644	2		Dr-22		1
	SD-A5	1225	2		Dr-23		1
	SD-A5a	481.5	1		Dr-25	M5x45	1
	CK-C5a	673	1		Dr-25a	M5x60	2
	Dr-A5c	19.5	1		Dr-26	ST4x12	3
	VT-A11	1395	2		Dr-27	ST4.2x25	2
	SD-A11	1225	2		Dr-24		8
	DO-B11	1492	6		Dr-28		8
	AT-7	29.5	8		DO-28a		4
	SD-A6	441	2		SD-B30	ST4x10	8
	SD-A6a	611	2		SD-B31	ST4.2x13	60
	DO-B6	163	4		SD-B32	M8x60	12
	DO-A6b	77.5	14		SD-B33	ST5.5x38	24
	SD-A7	1375	1		SD-B34	ST6x40	3
	AT-8		2		SD-B35	Ø6	3
					SD-B36	ST4.8x38	12



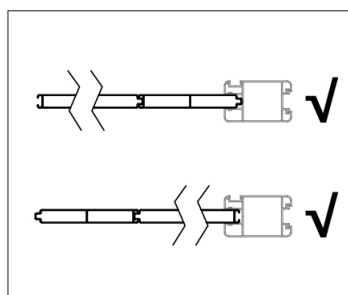
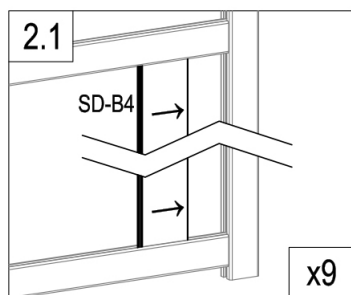
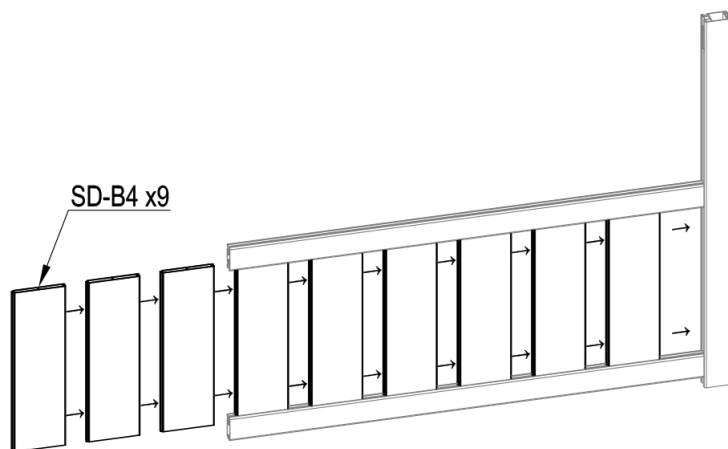



	DO-B3a (+DO-B15)	1
	SD-A1	1
	DO-B3	1
	DO-28a	1
	Dr-28	1
	SD-B33	4

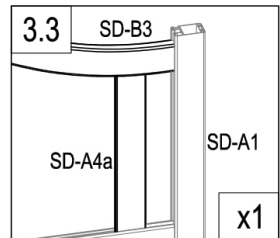
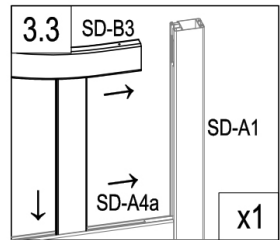
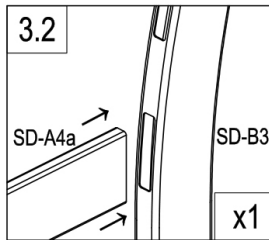
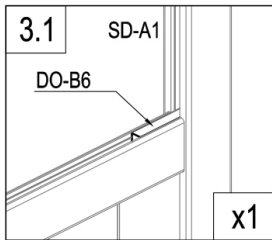
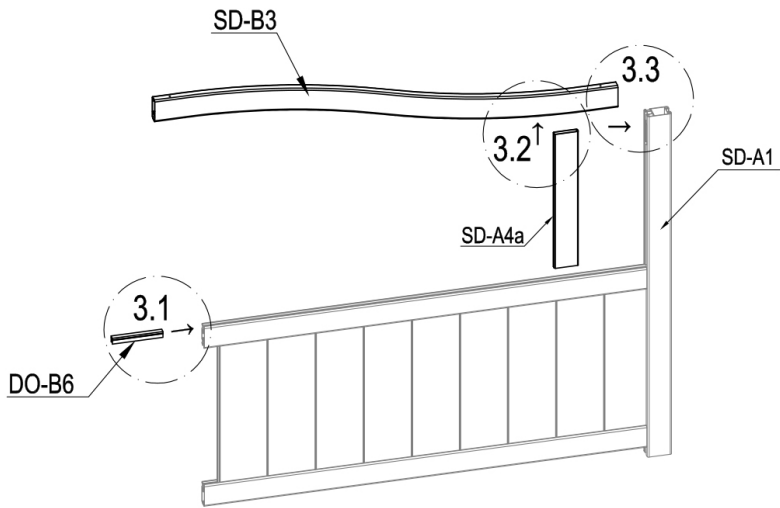

	SD-B4	9
---	-------	---



# CASANOVO



	SD-A4a	1
	DO-B6	1
	SD-B3	1

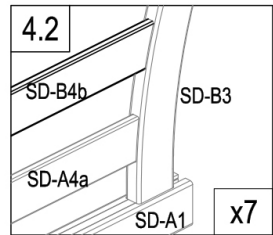
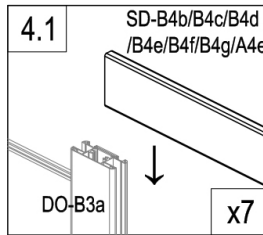
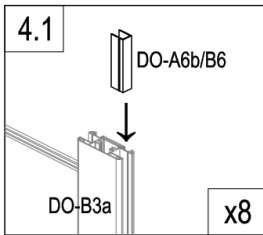
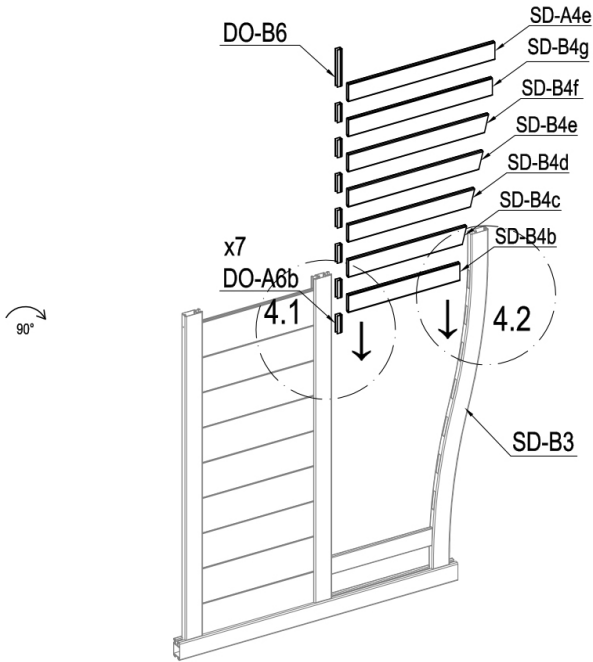



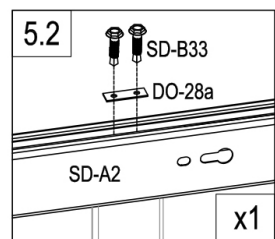
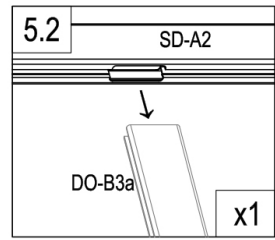
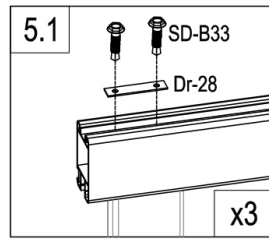
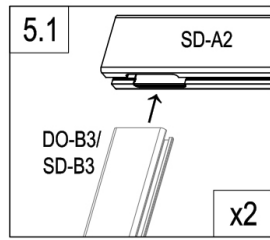
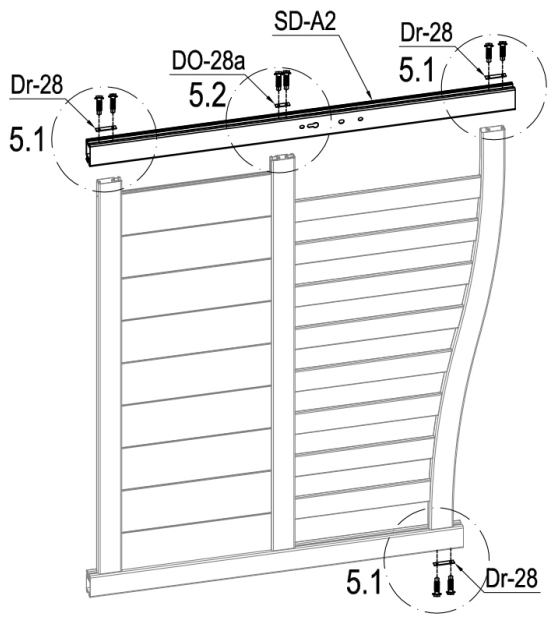

	SD-B4b	1		SD-B4g	1
	SD-B4c	1		SD-A4e	1
	SD-B4d	1		DO-B6	1
	SD-B4e	1		DO-A6b	7
	SD-B4f	1			



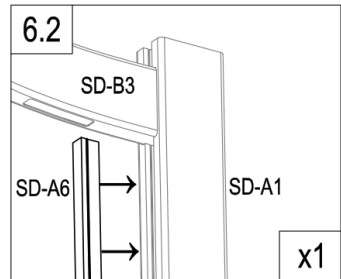
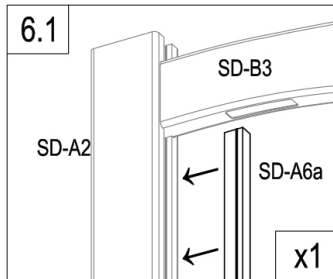
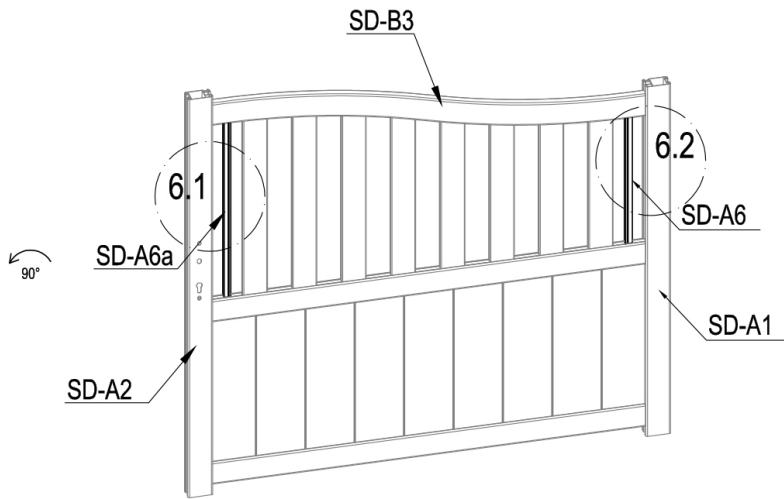

	SD-A2	1
	DO-28a	1
	Dr-28	3
	SD-B33	8

# CASANOVO

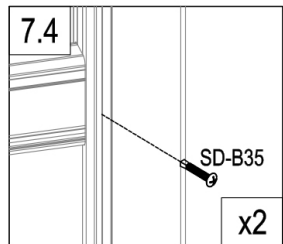
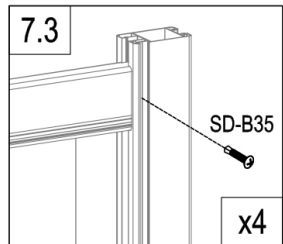
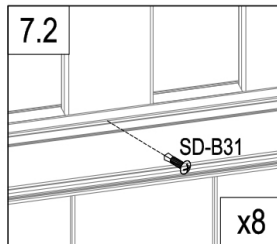
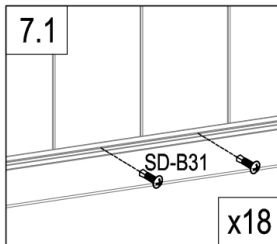
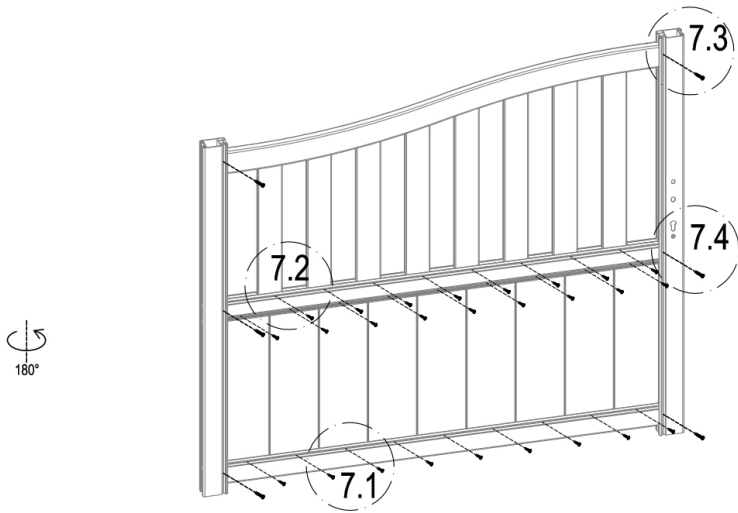

	SD-A6	1
	SD-A6a	1



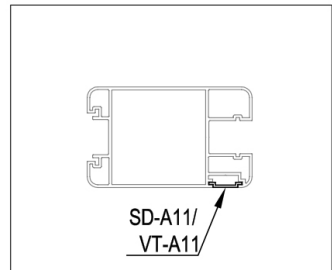
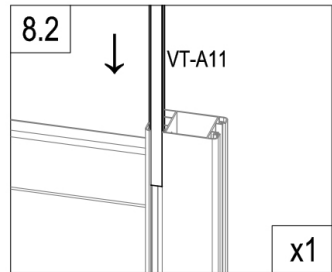
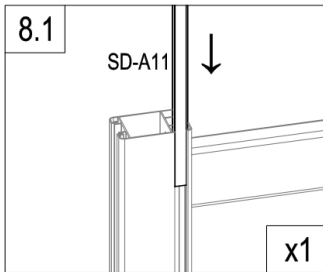
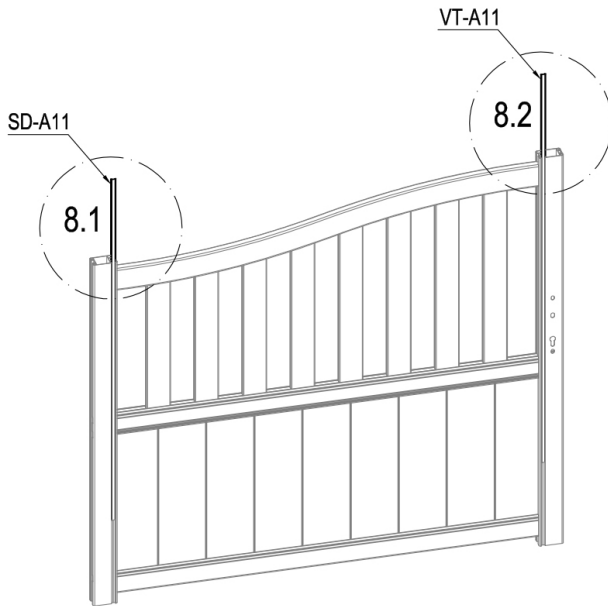

	SD-B31	26
	SD-B35	6

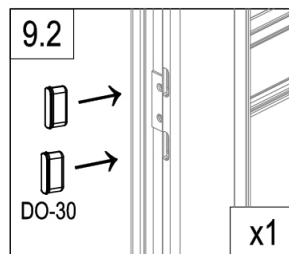
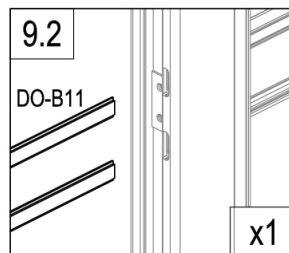
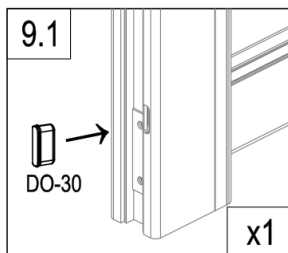
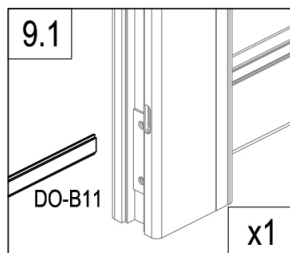
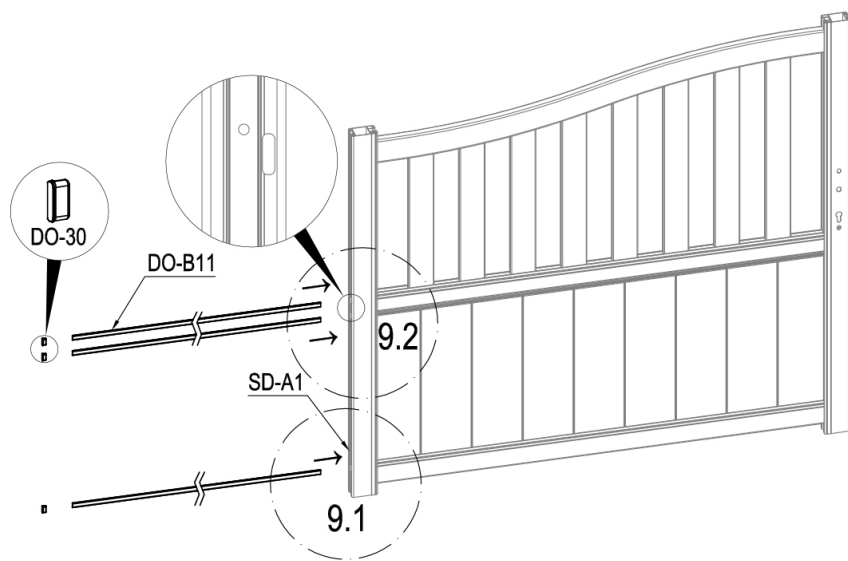

	SD-A11	1
	VT-A11	1



	DO-B11	3
	DO-30	3

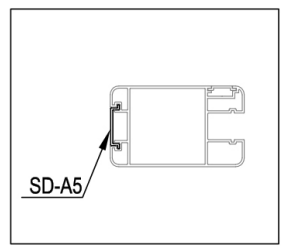
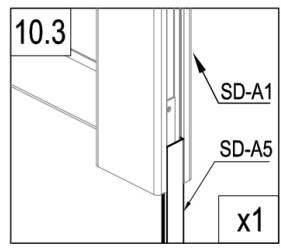
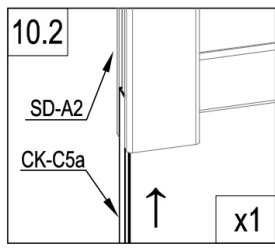
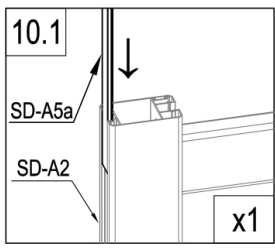
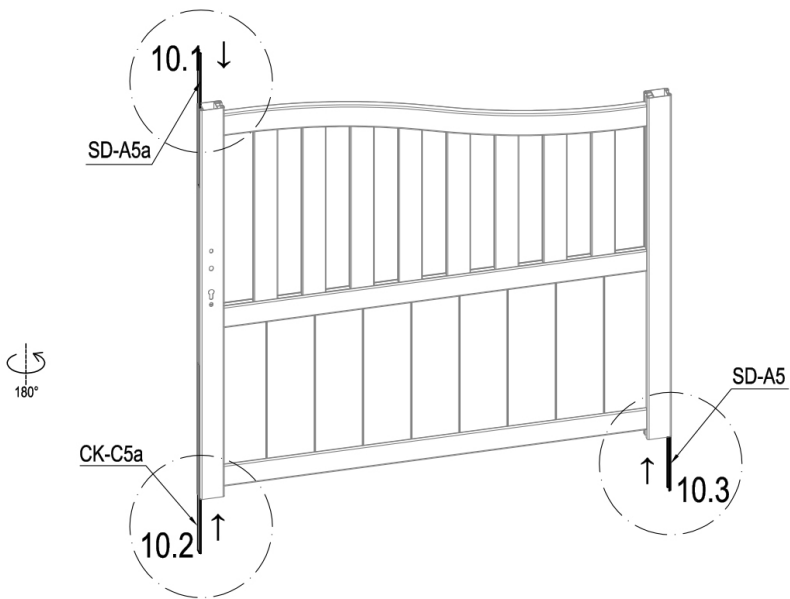

	SD-A5	1
	SD-A5a	1
	CK-C5a	1

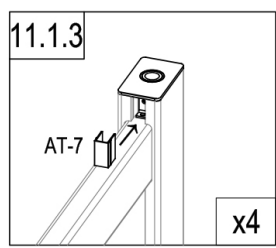
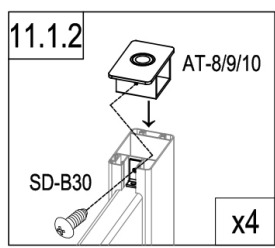
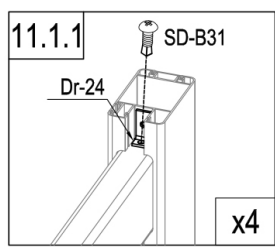
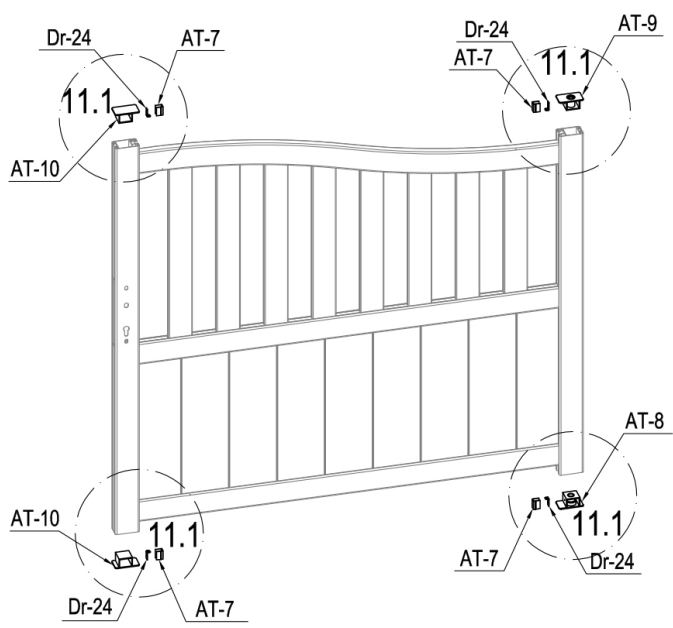

	AT-8	1
	AT-9	1
	AT-10	2
	Dr-24	4

	AT-7	4
	SD-B30	4
	SD-B31	4



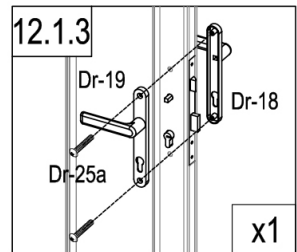
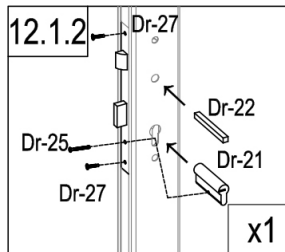
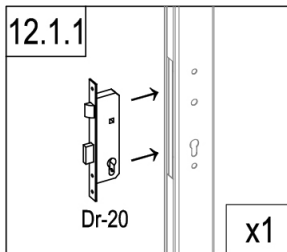
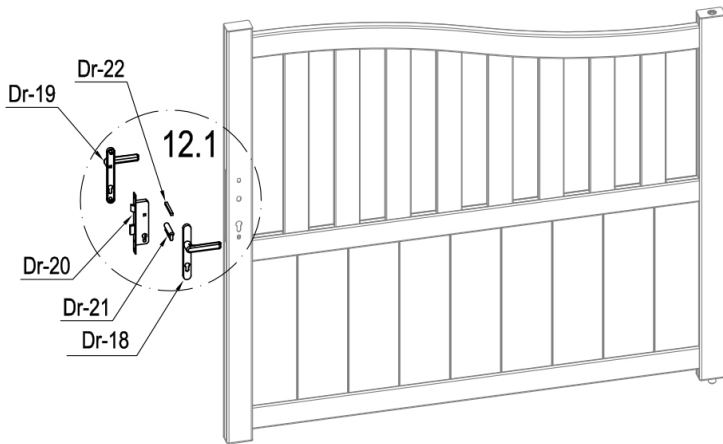

	Dr-20	1
	Dr-21	1
	Dr-22	1
	Dr-25	1

	Dr-18	1
	Dr-19	1
	Dr-25a	2
	Dr-27	2

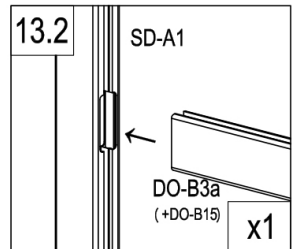
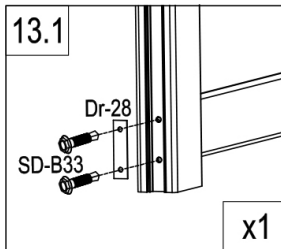
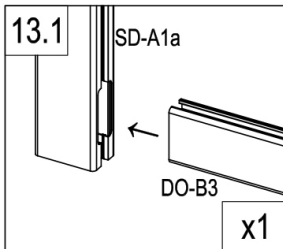
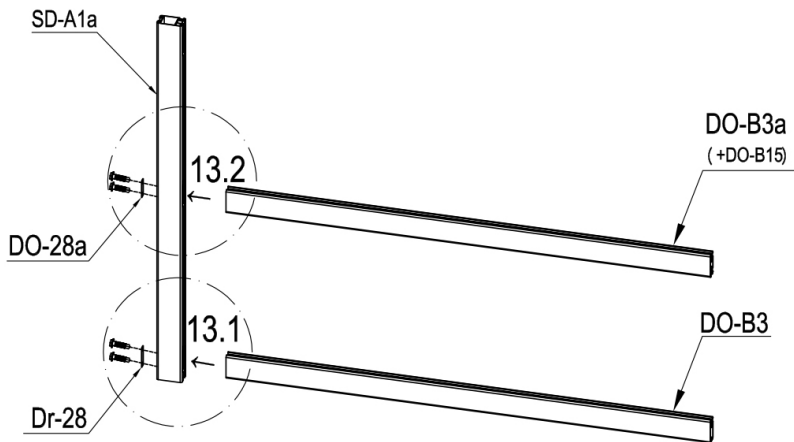



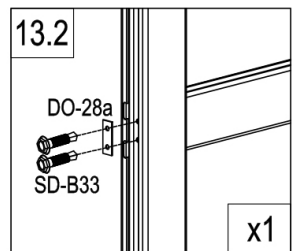

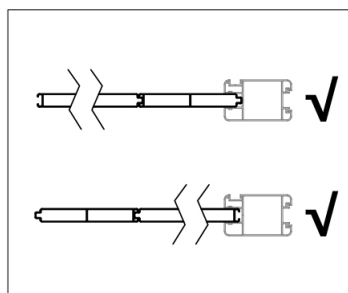
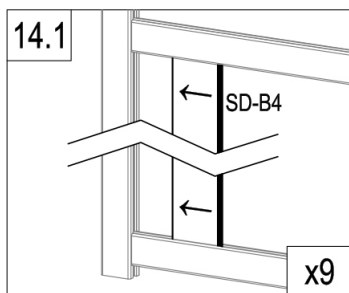
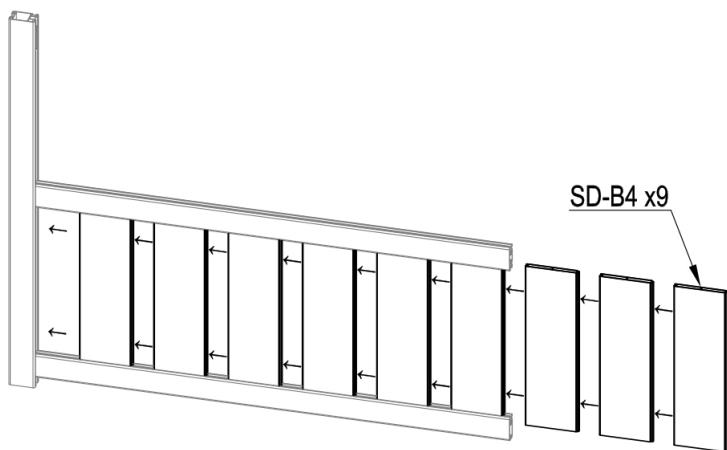
	DO-B3a (+DO-B15)	1
	SD-A1a	1
	DO-B3	1
	DO-28a	1
	Dr-28	1
	SD-B33	4



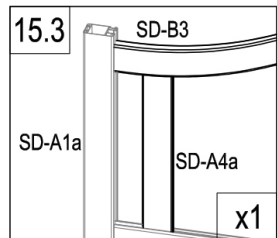
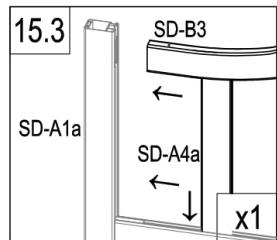
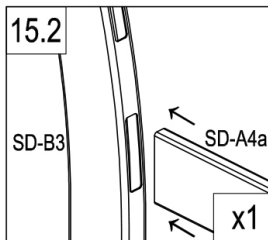
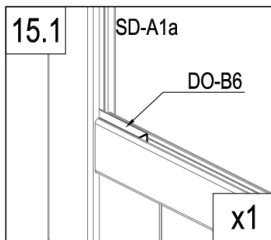
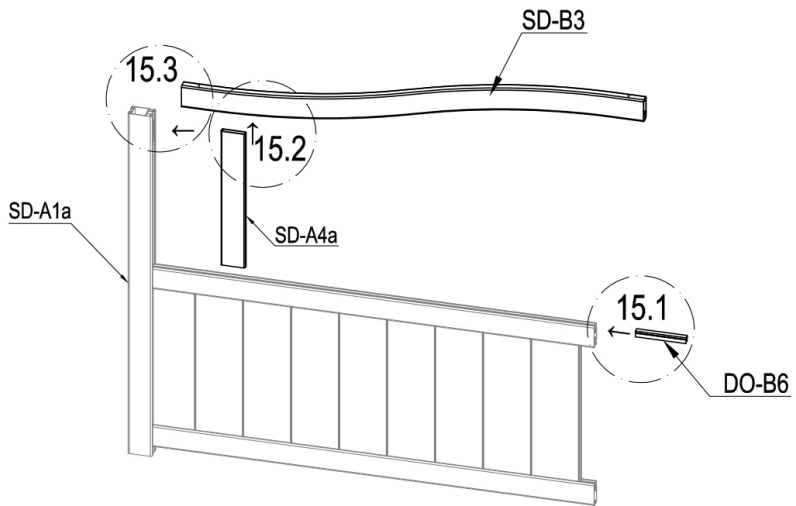



	SD-B4	9
---	-------	---



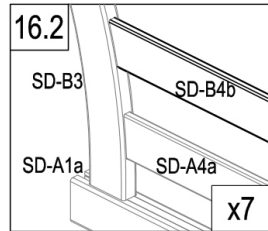
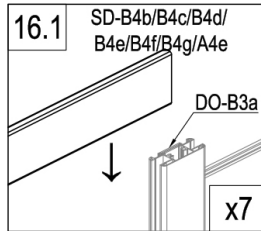
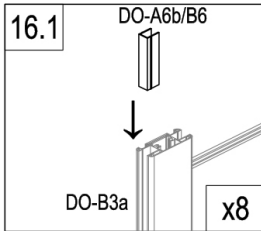
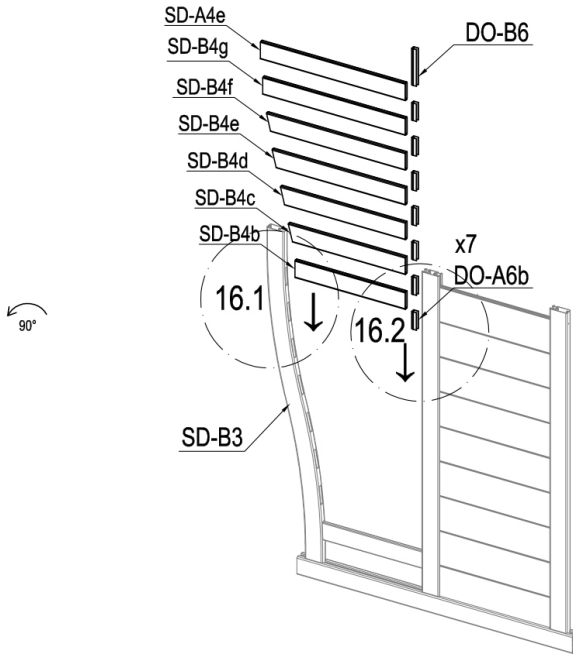



	SD-A4a	1
	DO-B6	1
	SD-B3	1

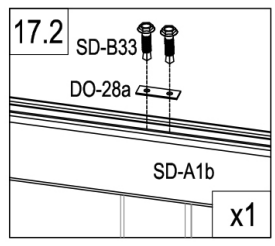
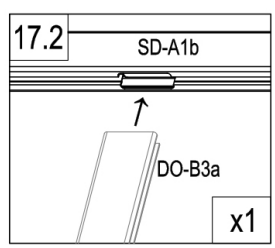
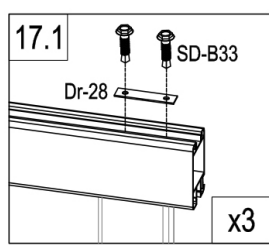
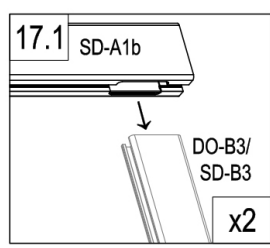
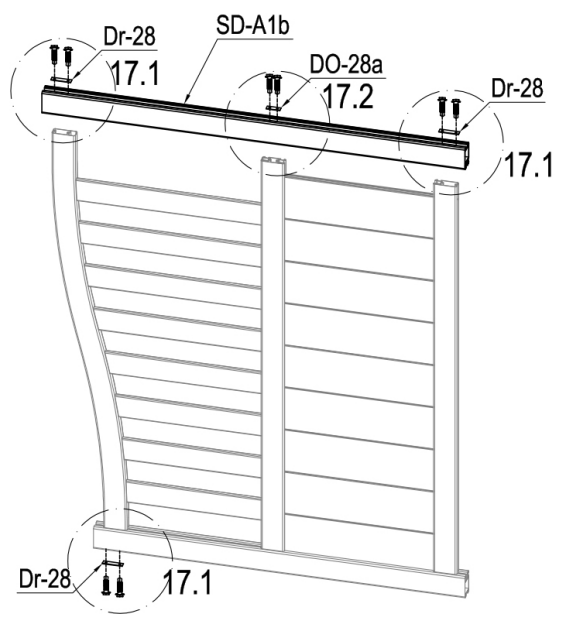

	SD-B4b	1		SD-B4g	1
	SD-B4c	1		SD-A4e	1
	SD-B4d	1		DO-B6	1
	SD-B4e	1		DO-A6b	7
	SD-B4f	1			



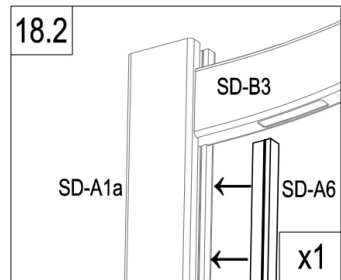
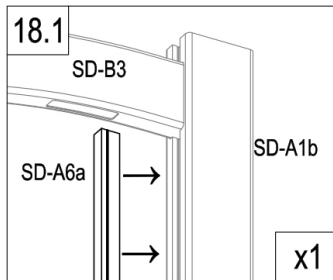
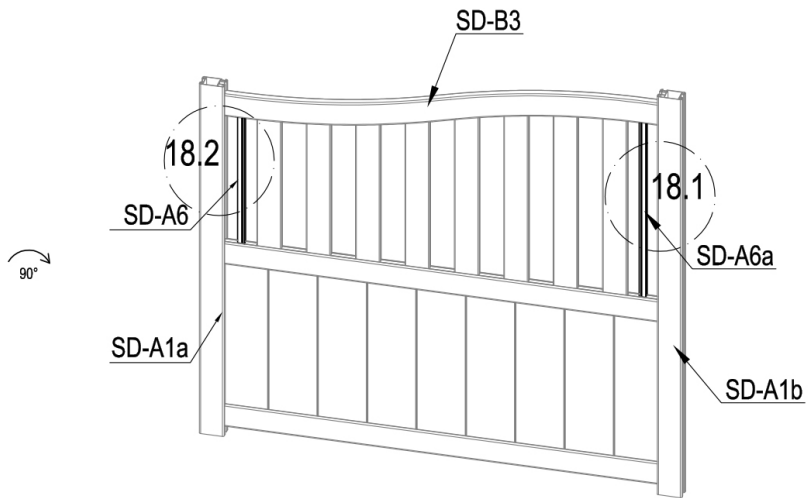

	SD-A1b	1
	DO-28a	1
	Dr-28	3
	SD-B33	8



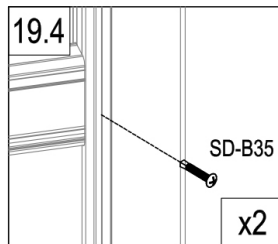
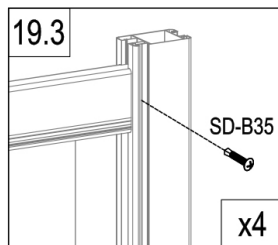
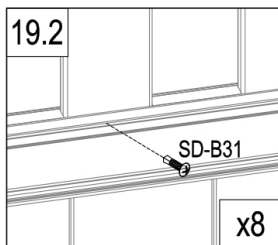
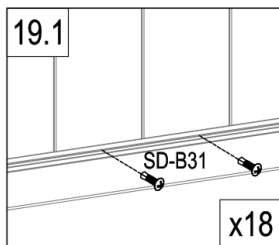
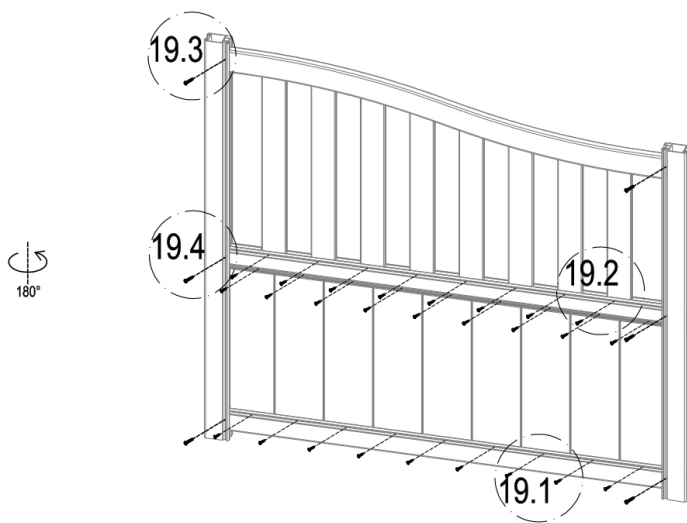

	SD-A6	1
	SD-A6a	1



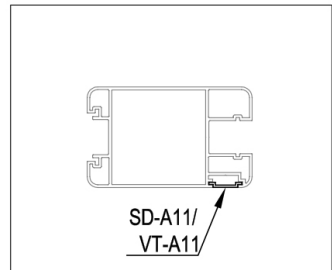
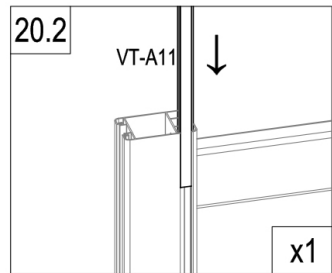
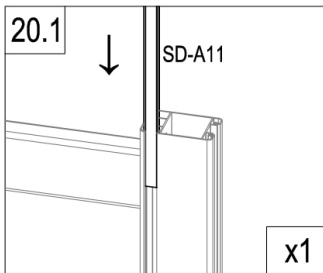
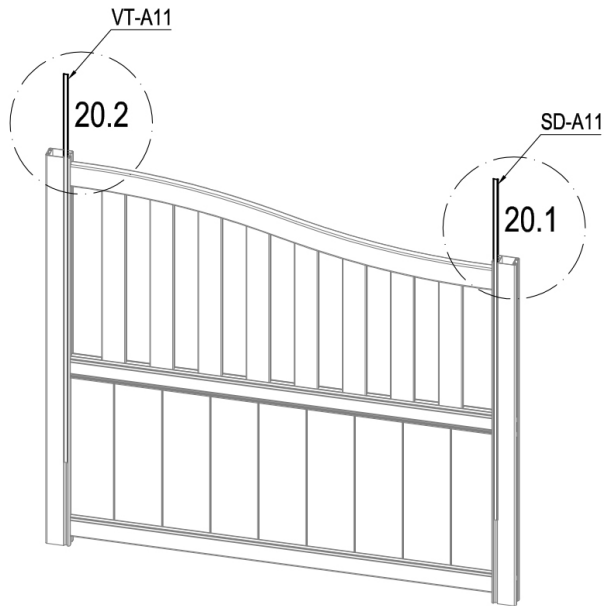

	SD-B31	26
	SD-B35	6





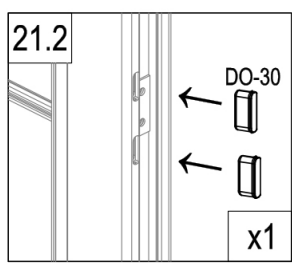
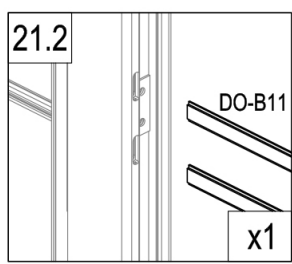
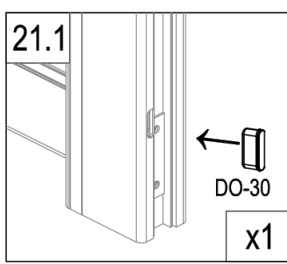
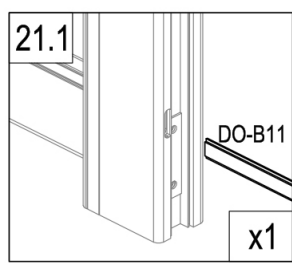
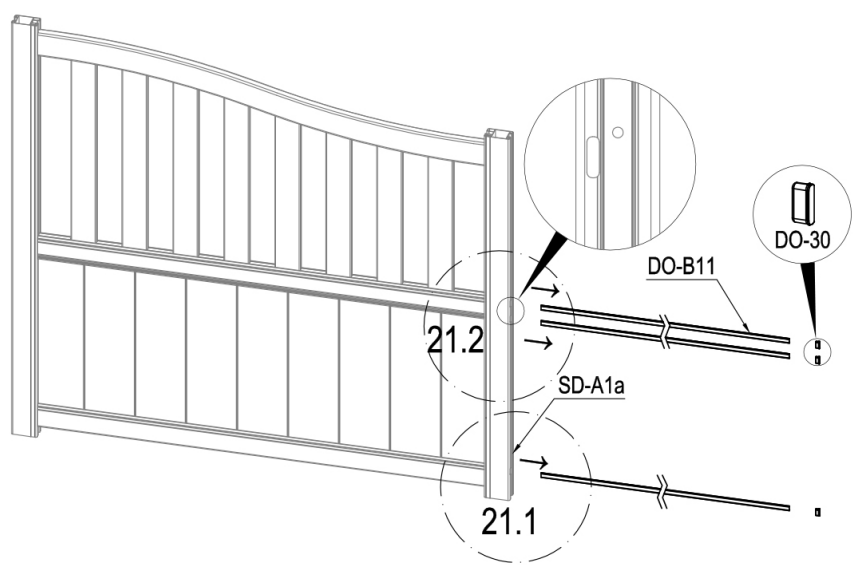

	SD-A11	1
	VT-A11	1

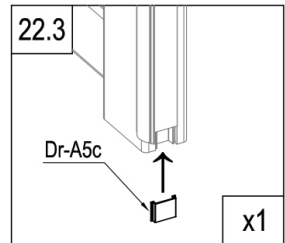
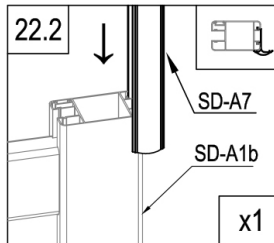
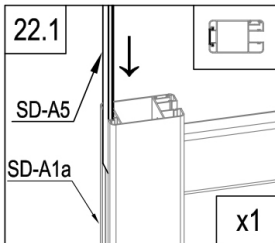
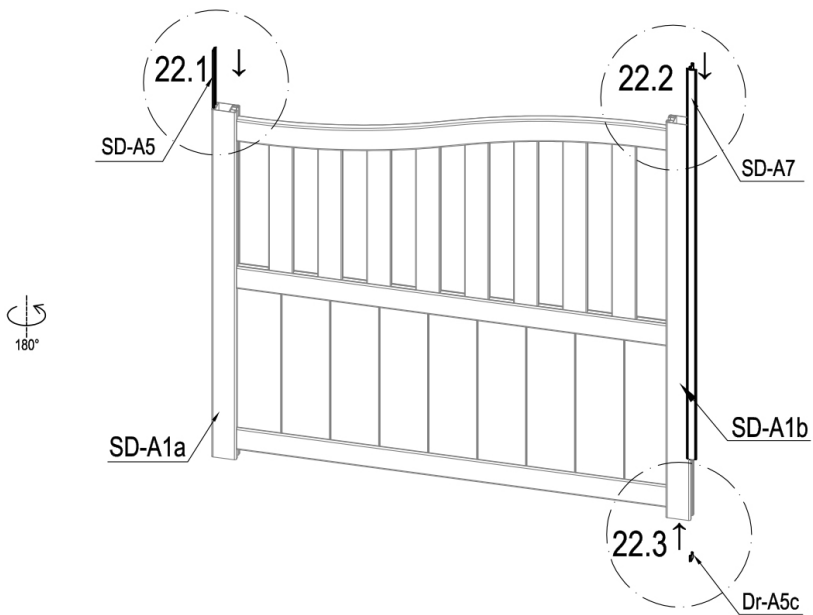

	DO-B11	3
	DO-30	3



	SD-A5	1
	Dr-A5c	1
	SD-A7	1

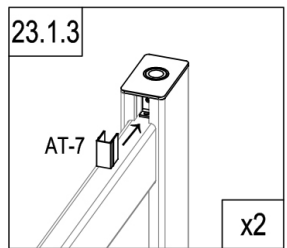
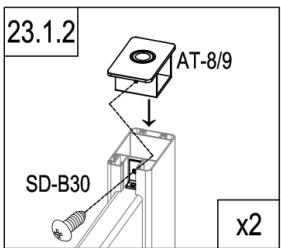
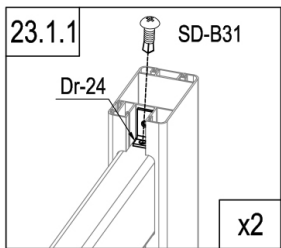
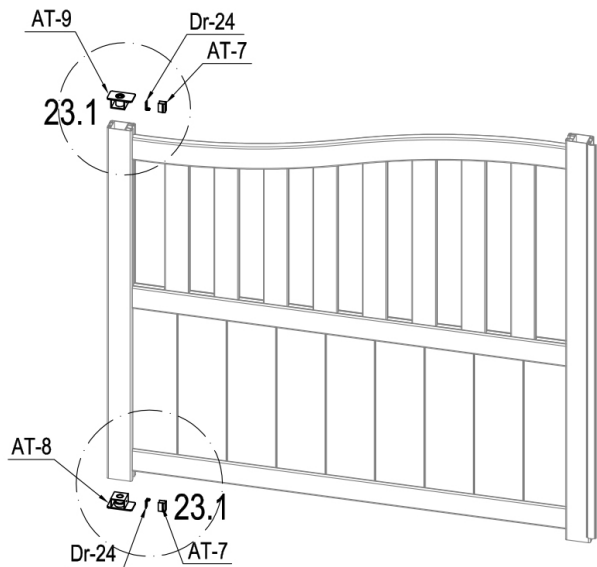

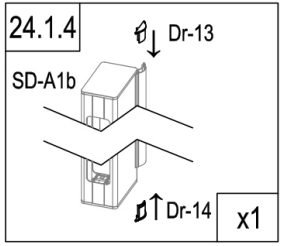
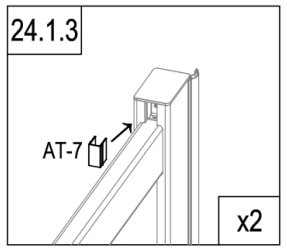
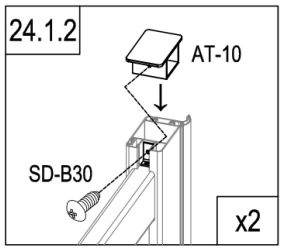
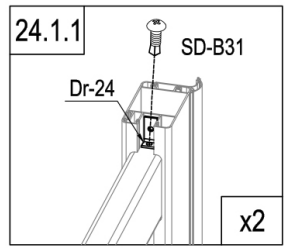
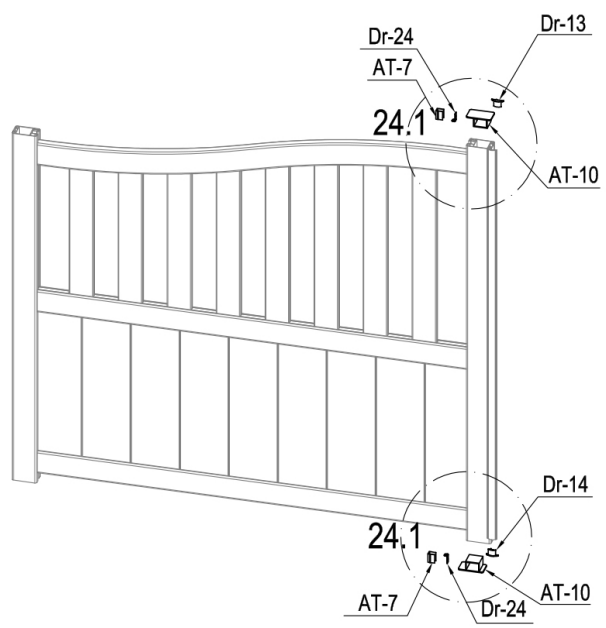

	AT-8	1
	AT-9	1
	Dr-24	2
	AT-7	2
	SD-B30	2
	SD-B31	2



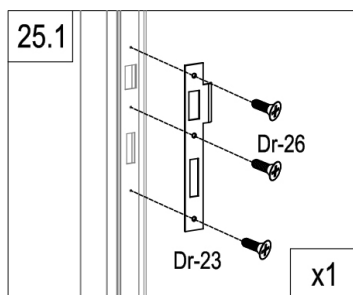
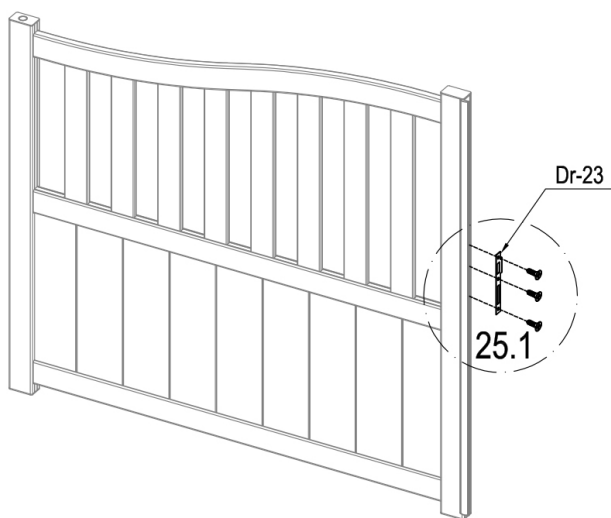

	AT-10	1
	Dr-24	2
	AT-7	2
	Dr-13	1

	Dr-14	1
	SD-B30	2
	SD-B31	2



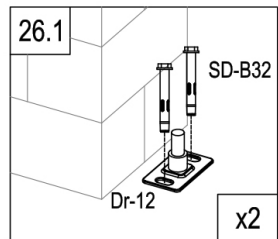
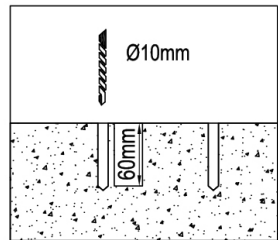
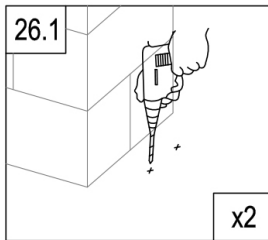
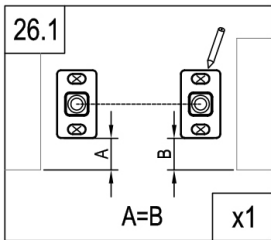
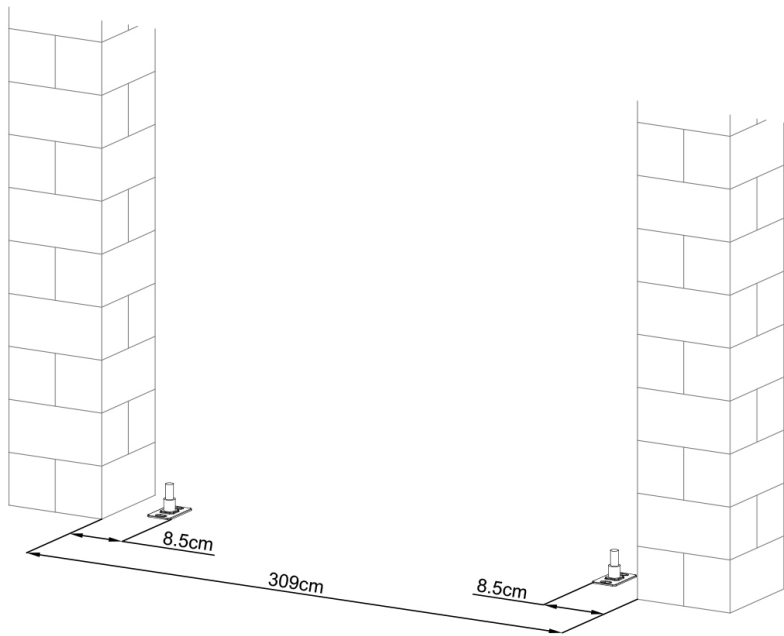

	Dr-23	1
	Dr-26	3

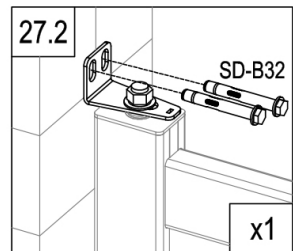
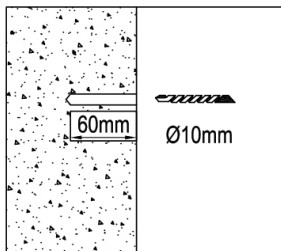
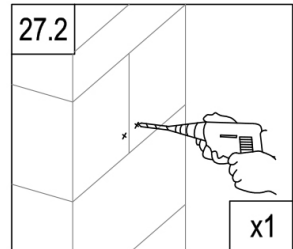
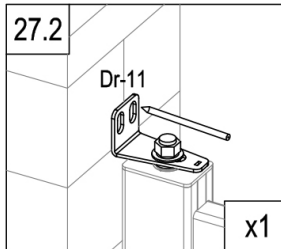
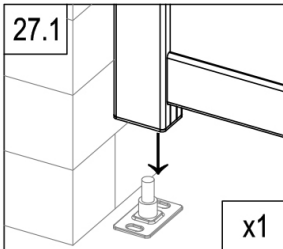
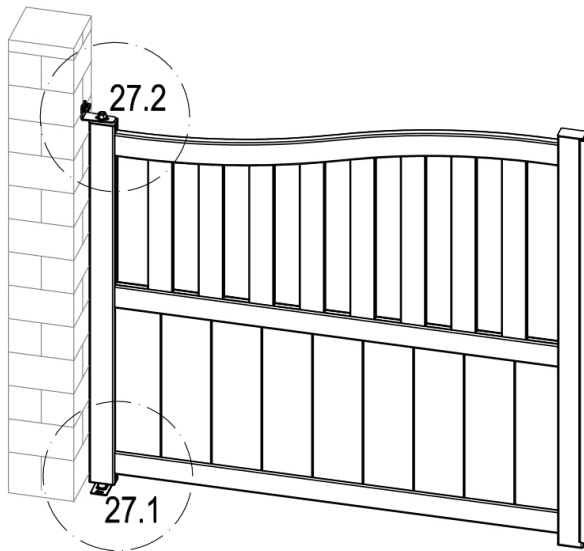

	Dr-12	2
	SD-B32	4





	Dr-11	1
	SD-B32	2



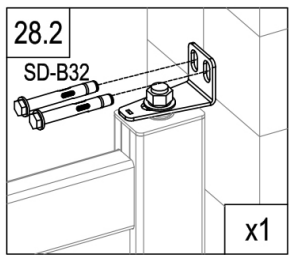
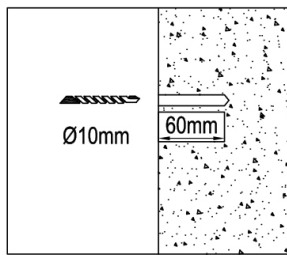
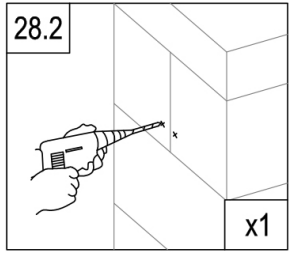
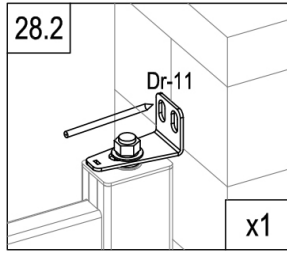
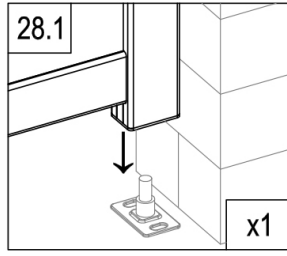
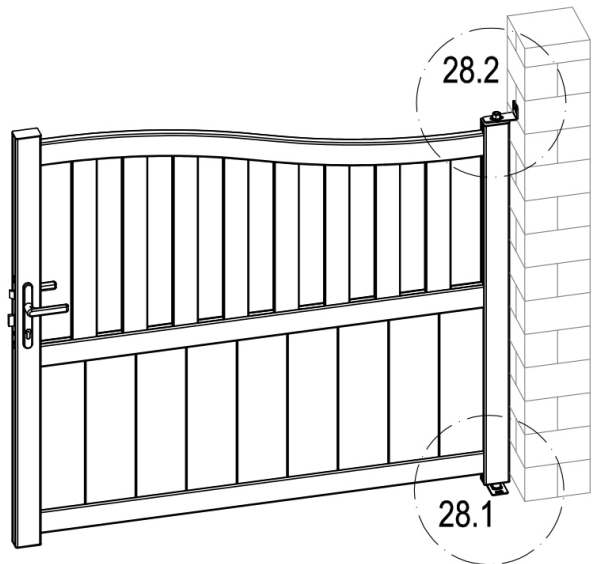

# CASANOVO

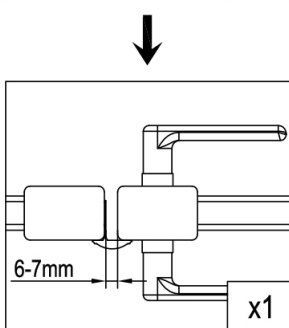
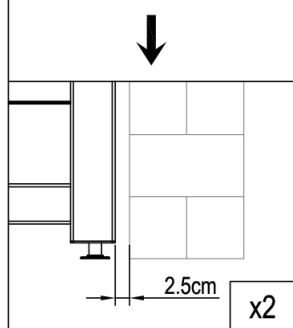
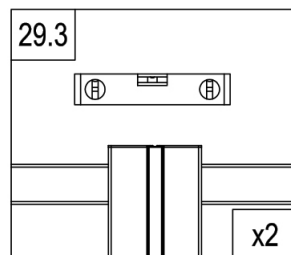
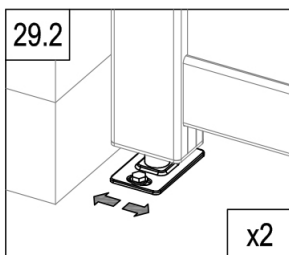
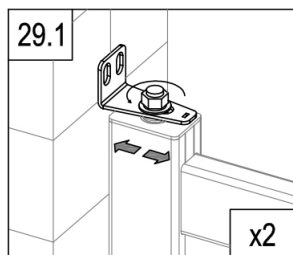
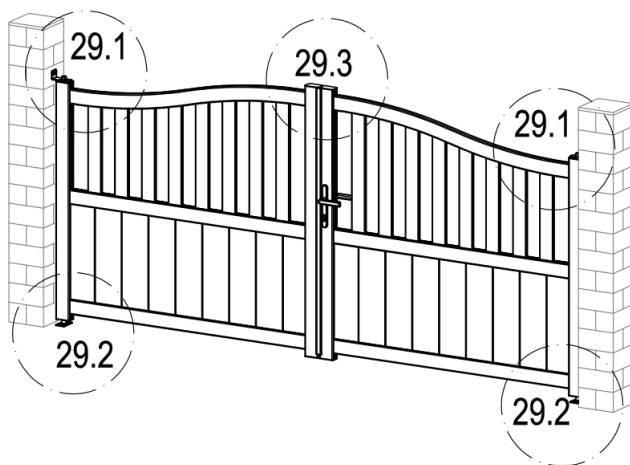

	Dr-11	1
	SD-B32	2

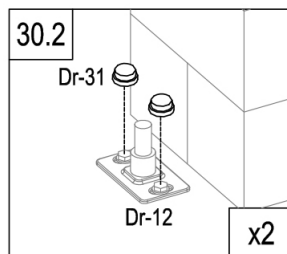
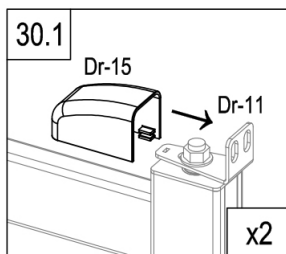
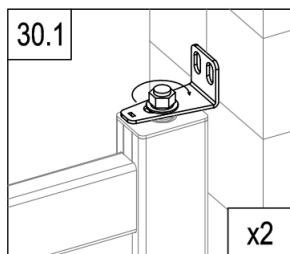
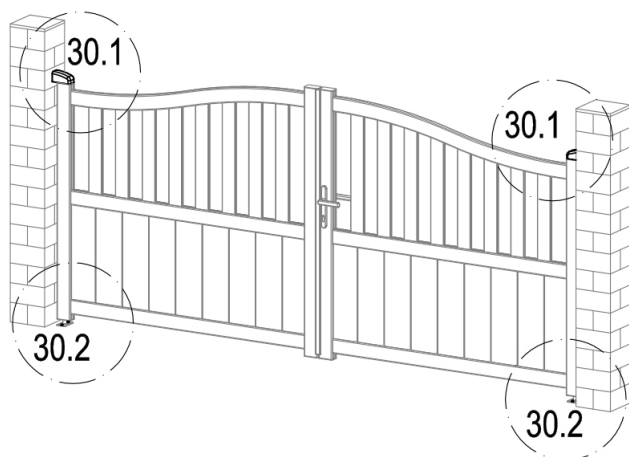





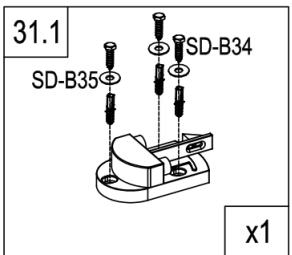
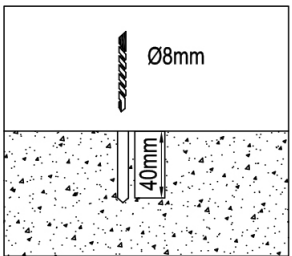
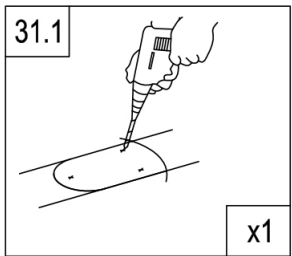
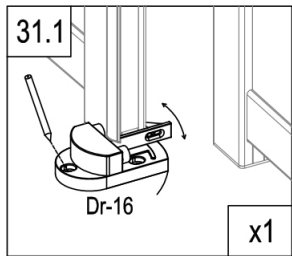
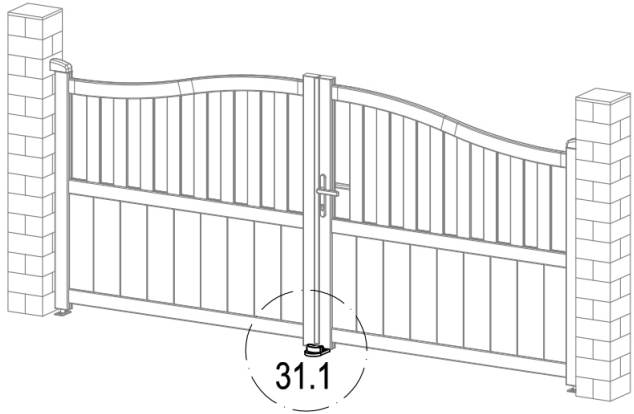

	Dr-15	2
	Dr-31	4

# CASANOVO

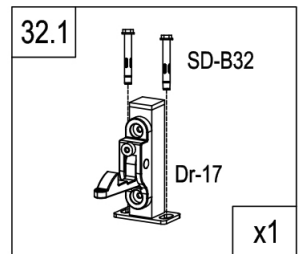
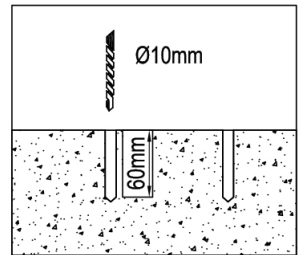
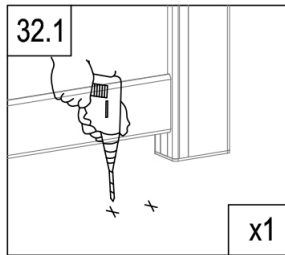
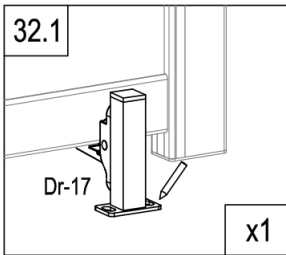
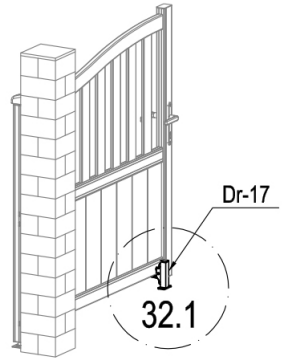
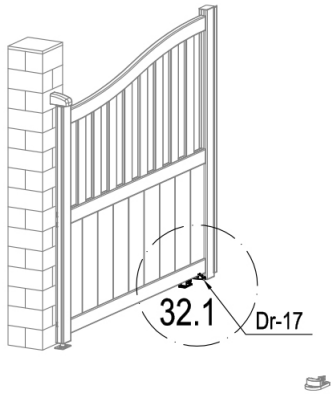

	Dr-16	1
	SD-B34	3
	SD-B35	3



	SD-B32	4
	Dr-17	2