

CASANOVO

GIONA 300B160

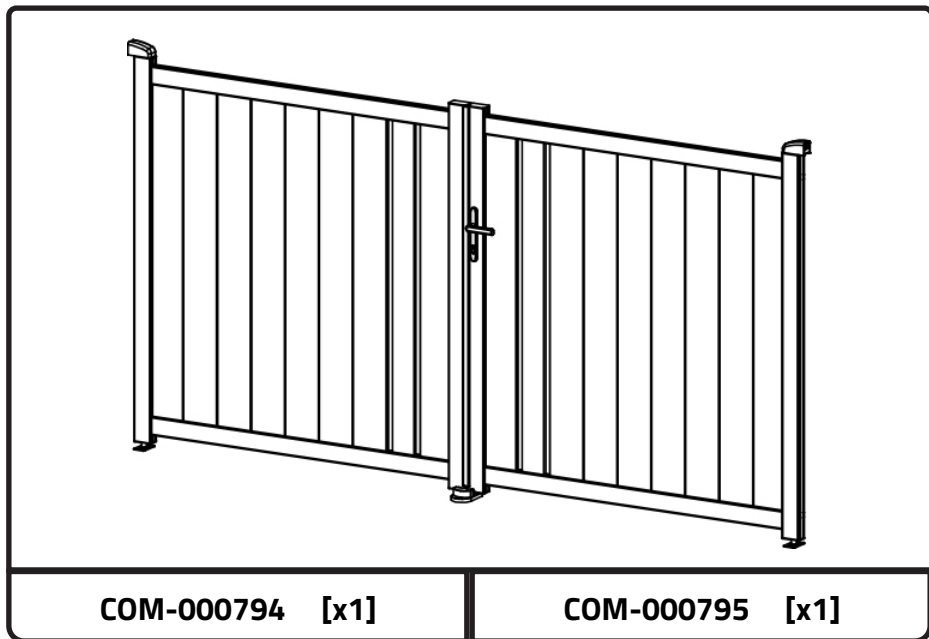

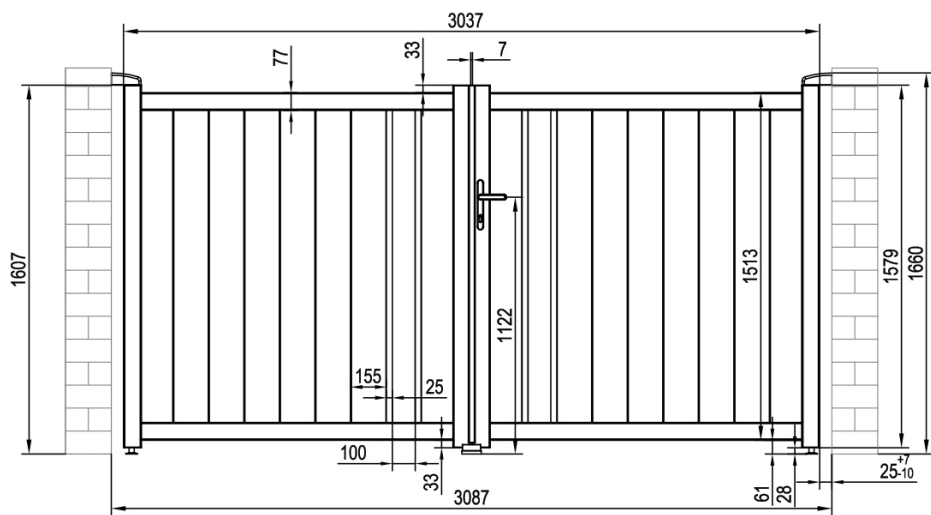



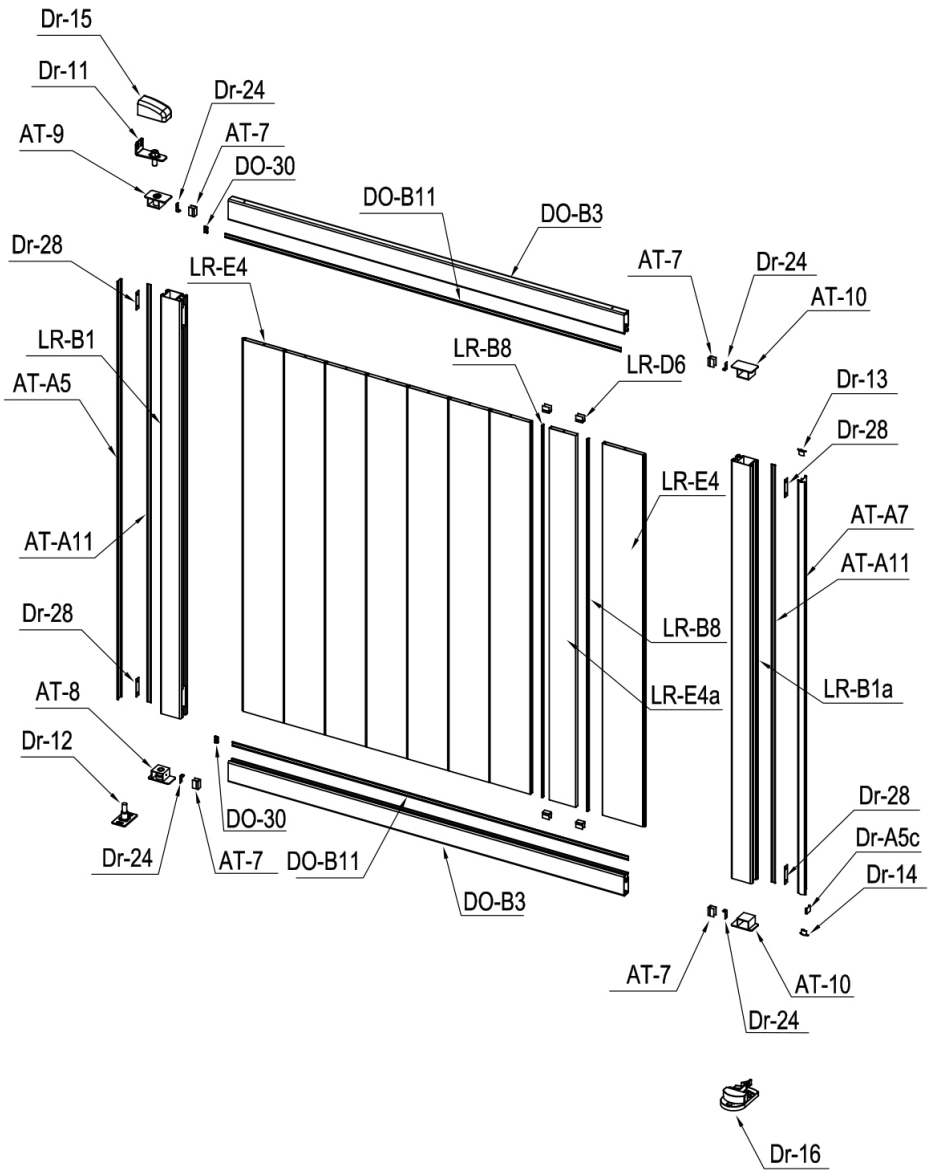

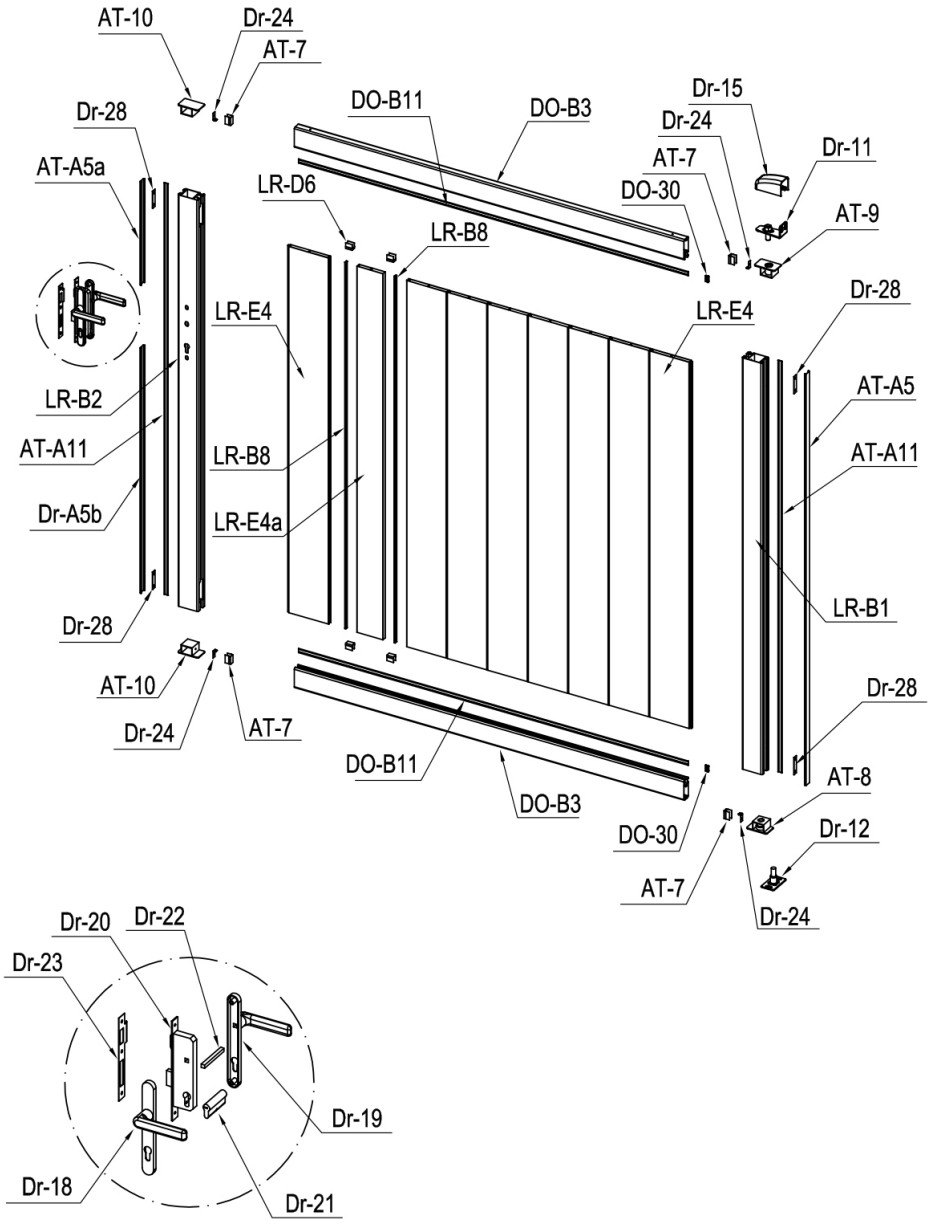

































INSTRUCTION MANUAL / NOTICE DE MONTAGE / MONTAGEANLEITUNG / MANUAL DE MONTAJE / MANUAL DE MONTAGEM / MANUALE DI MONTAGGIO /
MONTAGEHANDLEIDING / INSTRUKCJA MONTAŻU / KÄYTTÖOHJEET / BRUKSANVISNING / BRUGSANVISNING / INSTRUCIUNI DE ASAMBLARE /
NAVODILA ZA SESTAVLJANJE / NÁVOD NA MONTÁŽ / ÖSSZESZERELÉSI ÚTMUTATÓ / NÁVOD K MONTÁŽI / UPUTE ZA INSTALACIJU /
ΟΔΗΓΙΕΣ ΣΥΝΑΡΜΟΛΟΓΗΣΗΣ / SURINKIMO INSTRUKCIJOS / MONTĀŽAS INSTRUKCIJAS









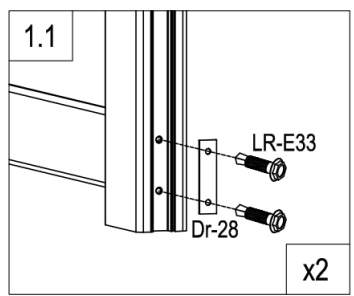
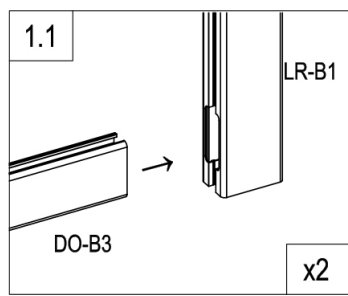
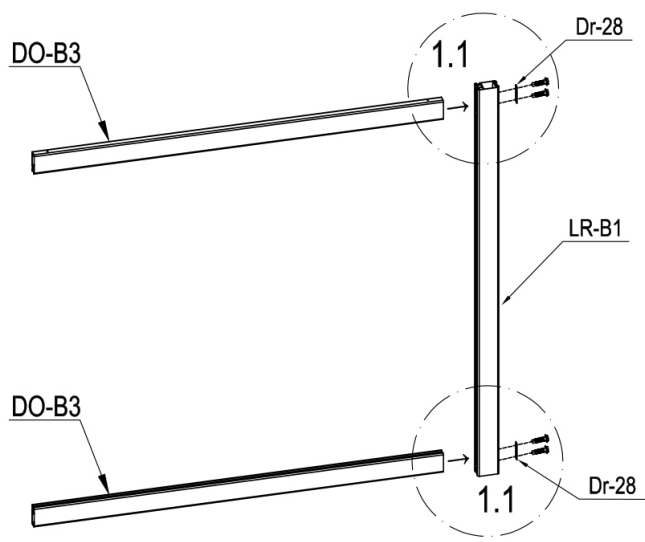

CASANOVO



IMAGE	NO.	L.(mm)	QTY	IMAGE	NO.	L.(mm)	QTY
	LR-B1	1573	2		Dr-17		2
	LR-B1a	1573	1		Dr-31		4
	LR-B2	1573	1		DO-30		4
	DO-B3	1492	4		Dr-18		1
	LR-E4	1400	16		Dr-19		1
	LR-E4a	1400	2		Dr-20		1
	AT-A5	1573	2		Dr-21		1
	AT-A5a	395.5	1		Dr-22		1
	Dr-A5b	937	1		Dr-23		1
	Dr-A5c	19.5	1		Dr-25		1
	AT-A11	1573	4		Dr-25a		2
	DO-B11	1492	4		Dr-26		3
	AT-7	29.5	8		Dr-27		2
	LR-D6	25	8		Dr-24		8
	LR-B8	1400	4		Dr-28		8
	AT-A7	1553	1		LR-E30		8
	AT-8		2		LR-E31		44
	AT-9		2		LR-E32		12
	AT-10		4		LR-E33		16
	Dr-11		2		LR-E34		3
	Dr-12		2		LR-E35		3
	Dr-13		1		LR-E36		8
	Dr-14		1				
	Dr-15		2				
	Dr-16		1				



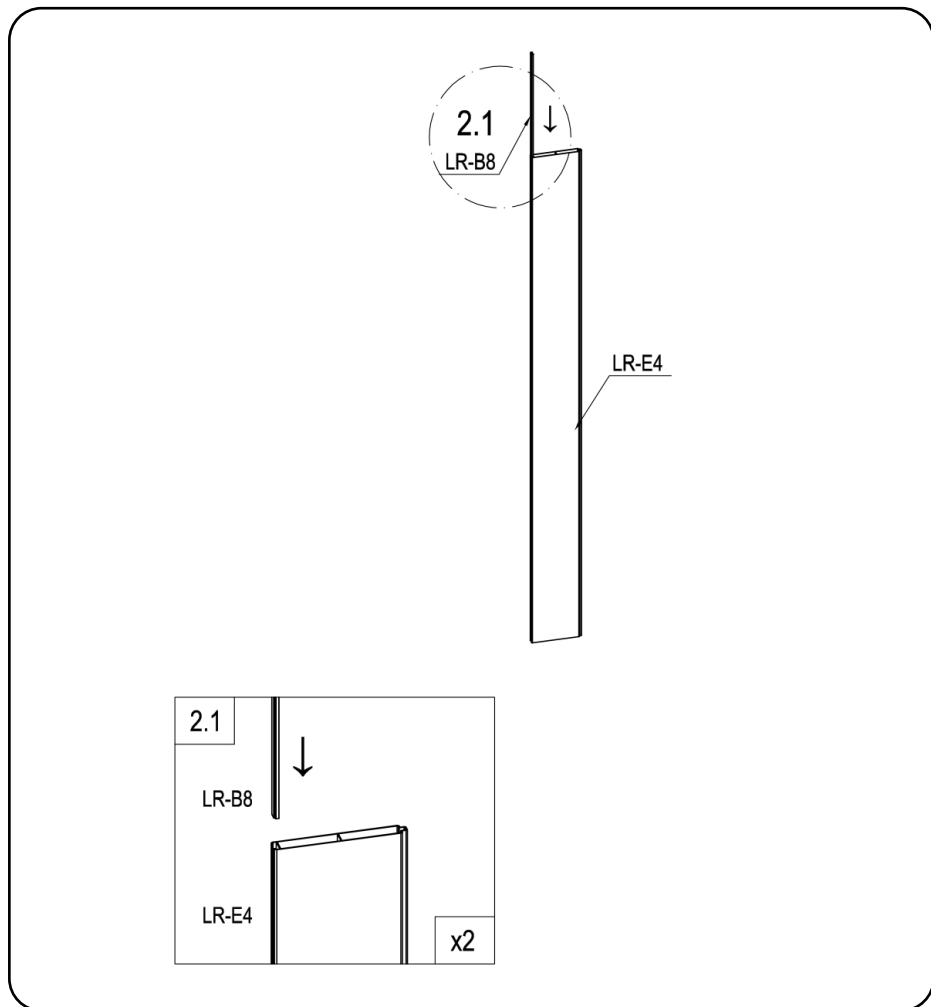

	LR-B1	1
	DO-B3	2
	Dr-28	2
	LR-E33	4



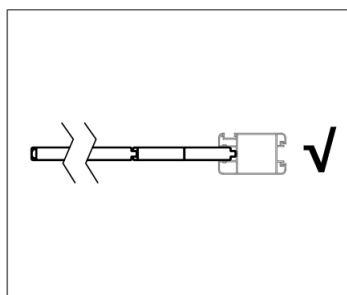
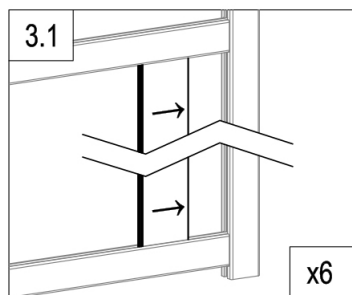
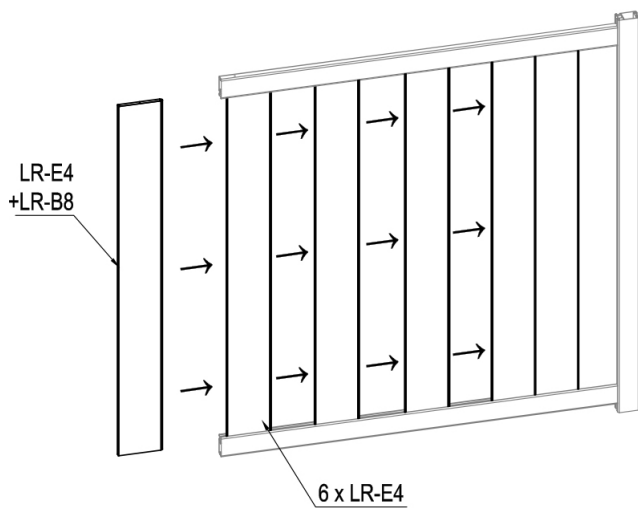

X2

	LR-B8	2
	LR-E4	2



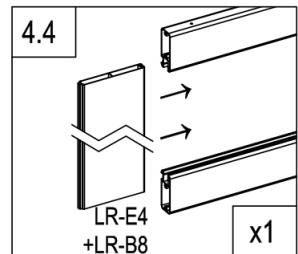
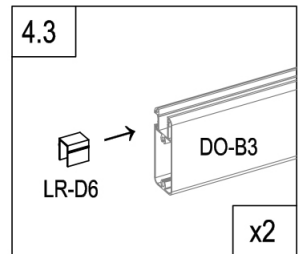
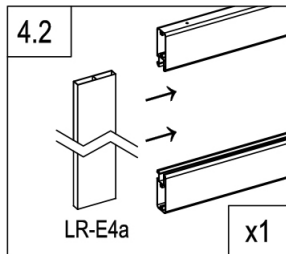
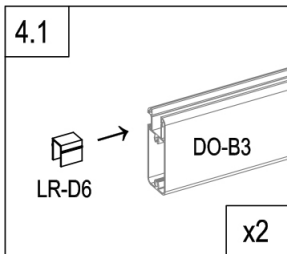
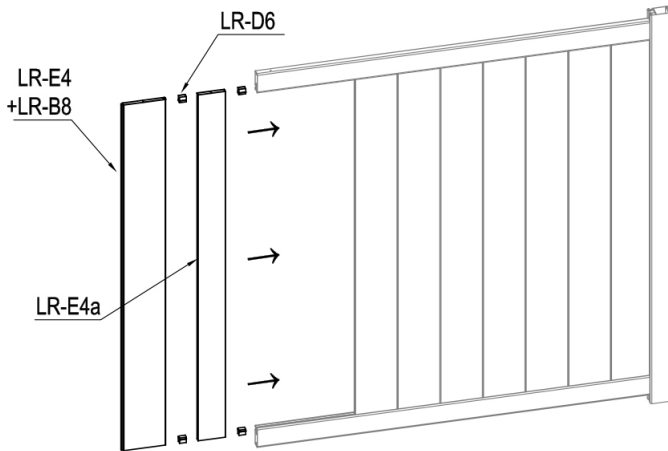

	LR-E4	6
---	-------	---



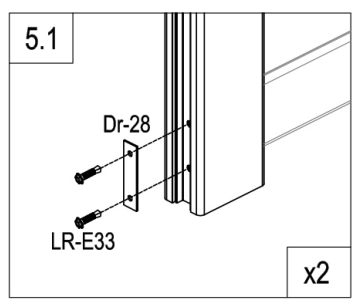
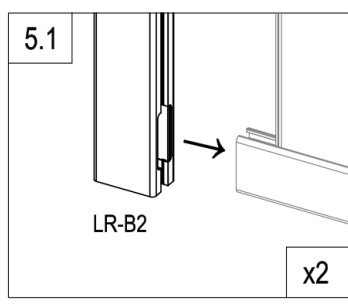
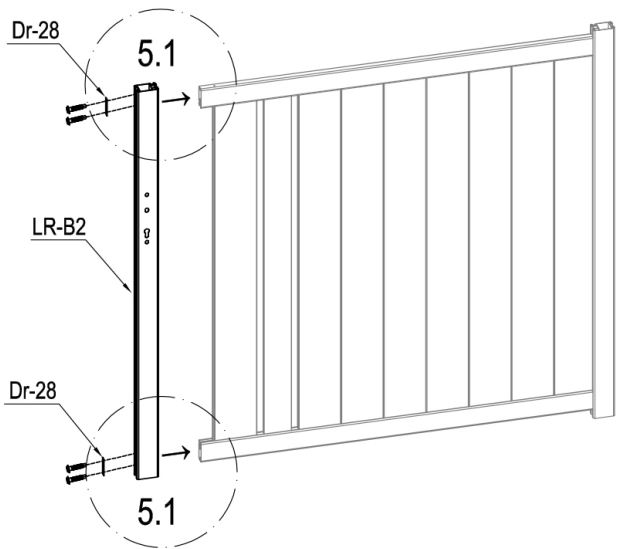

	LR-E4a	1
	LR-D6	4

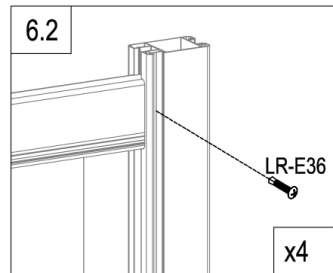
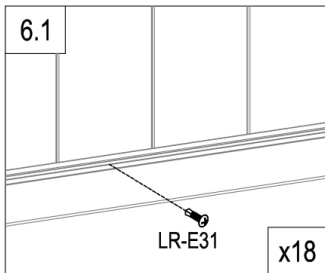
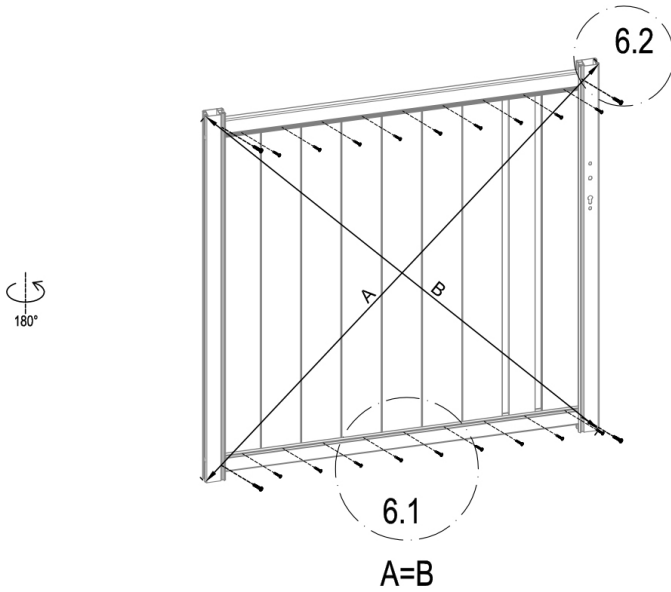

	LR-B2	1
	Dr-28	2
	LR-E33	4



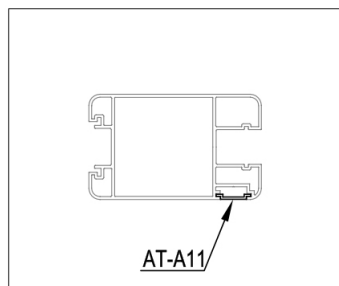
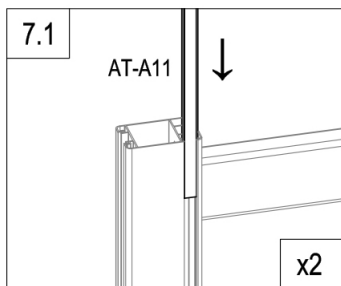
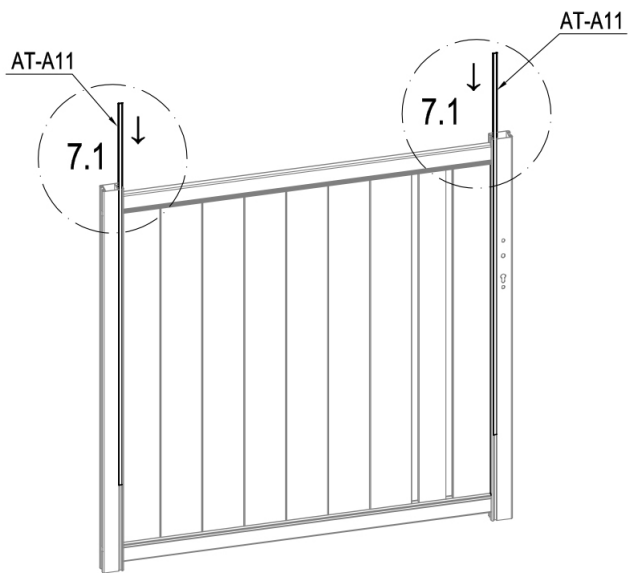

	LR-E31	18
	LR-E36	4

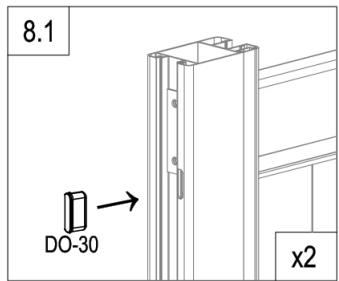
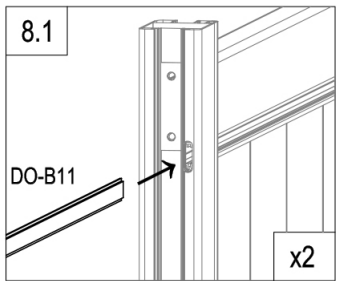
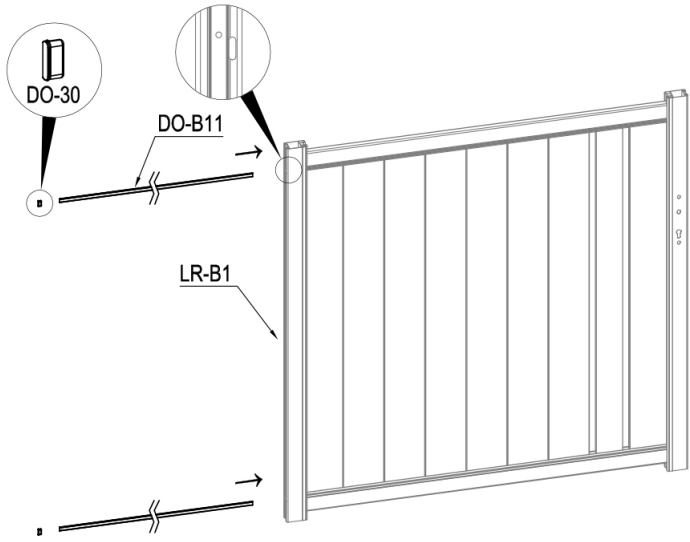

	AT-A11	2
---	--------	---



	DO-B11	2
	DO-30	2

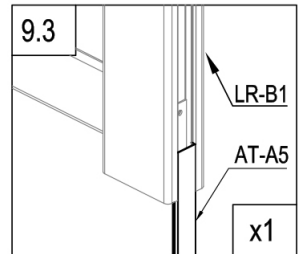
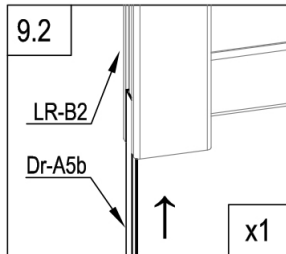
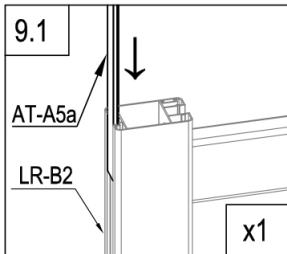
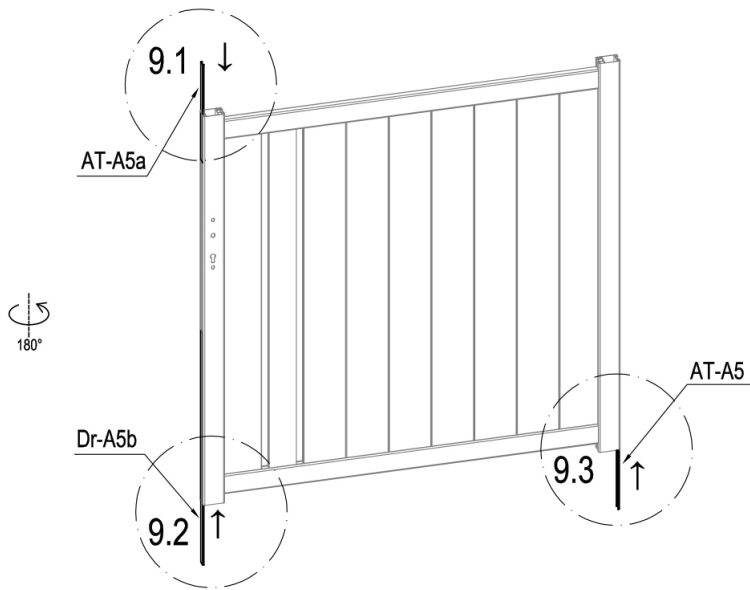

	AT-A5	1
	AT-A5a	1
	Dr-A5b	1

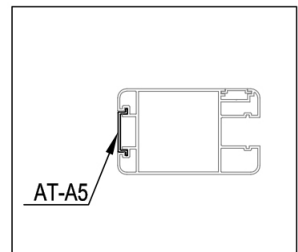

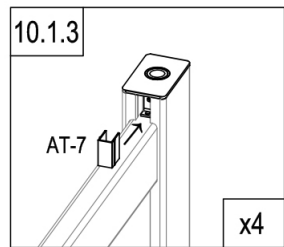
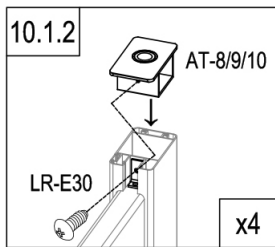
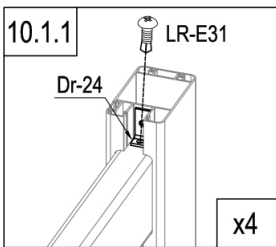
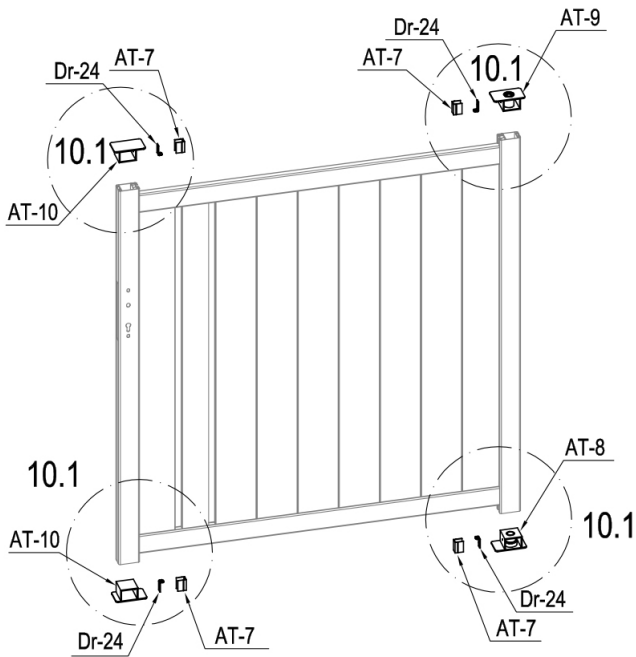





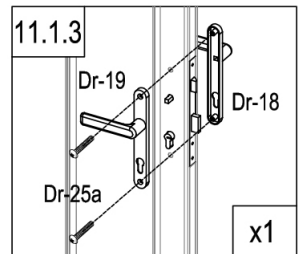
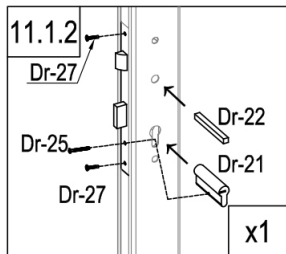
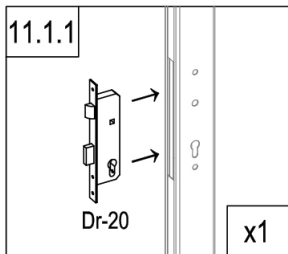
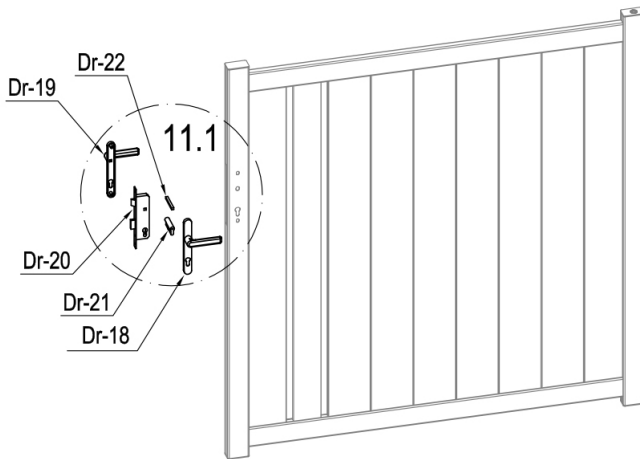



	AT-8	1
	AT-9	1
	AT-10	2
	Dr-24	4





	AT-7	4
	LR-E30	4
	LR-E31	4

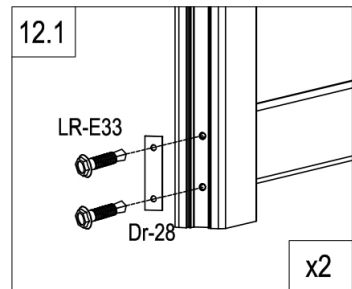
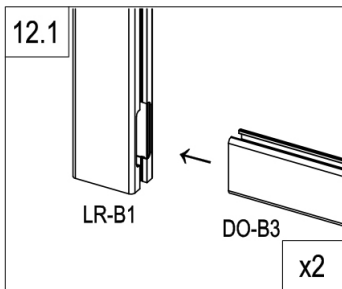
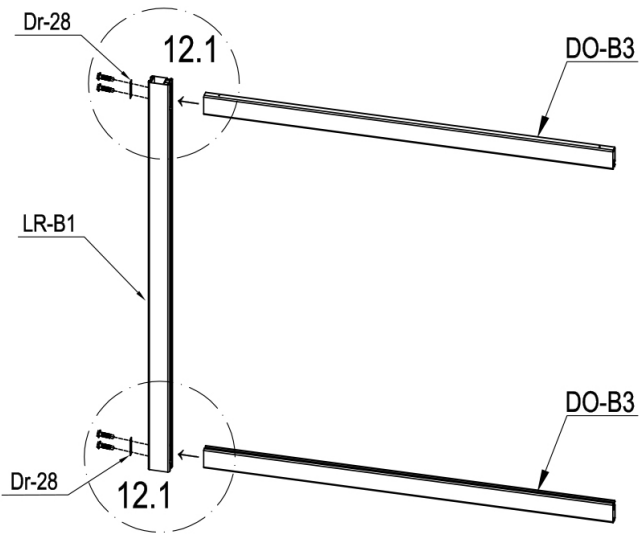

	Dr-20	1
	Dr-21	1
	Dr-22	1
	Dr-25	1



	Dr-18	1
	Dr-19	1
	Dr-25a	2
	Dr-27	2



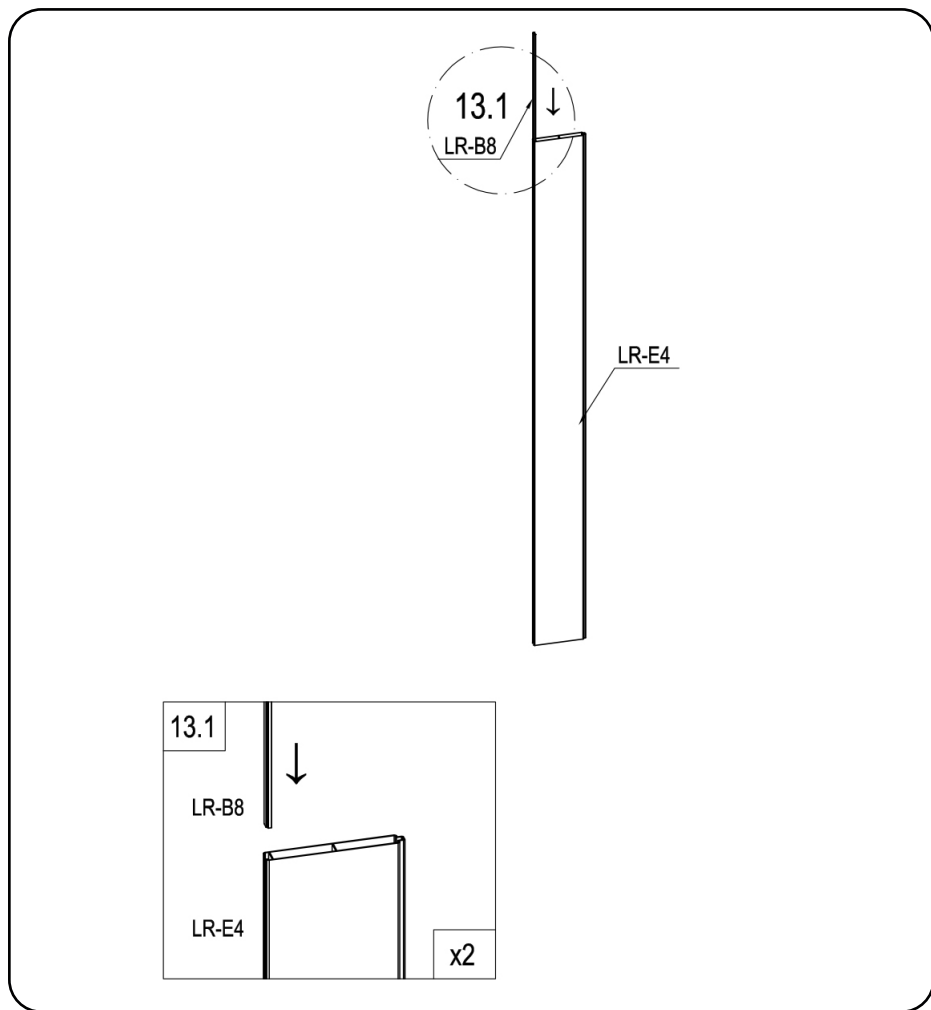

	LR-B1	1
	DO-B3	2
	Dr-28	2
	LR-E33	4



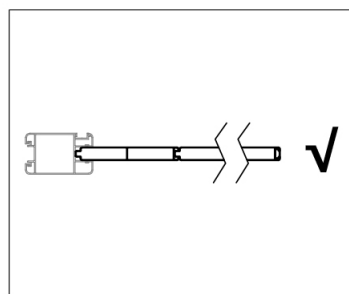
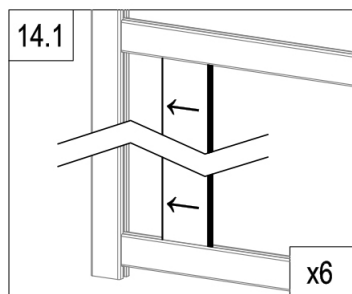
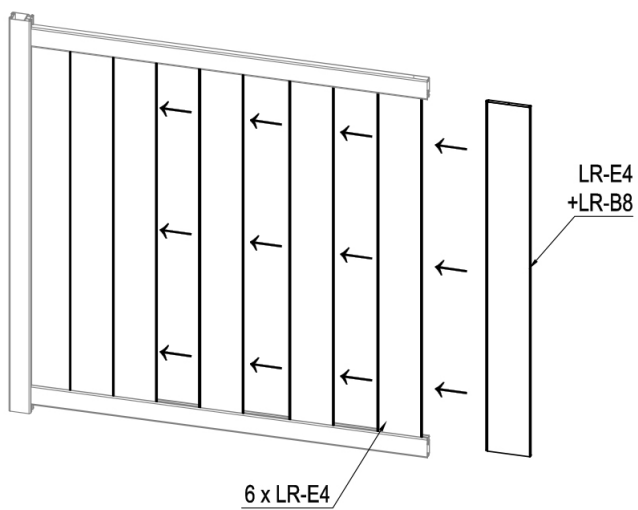

X2

	LR-B8	2
	LR-E4	2



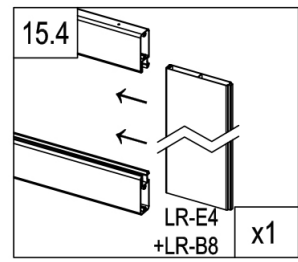
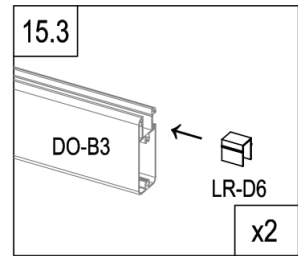
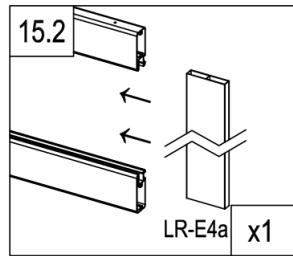
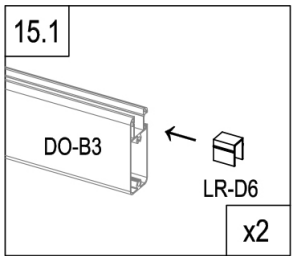
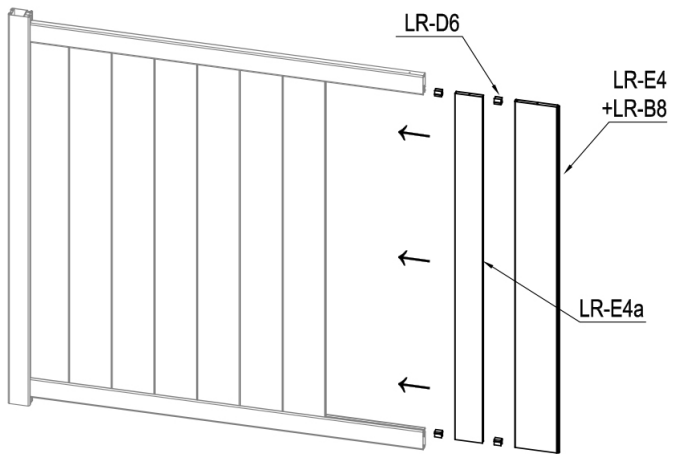

	LR-E4	6
---	-------	---



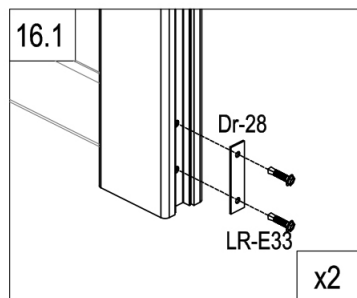
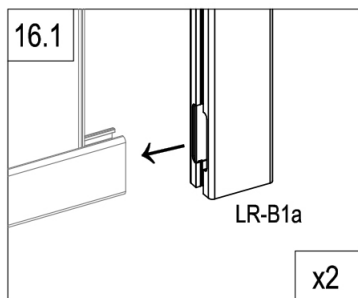
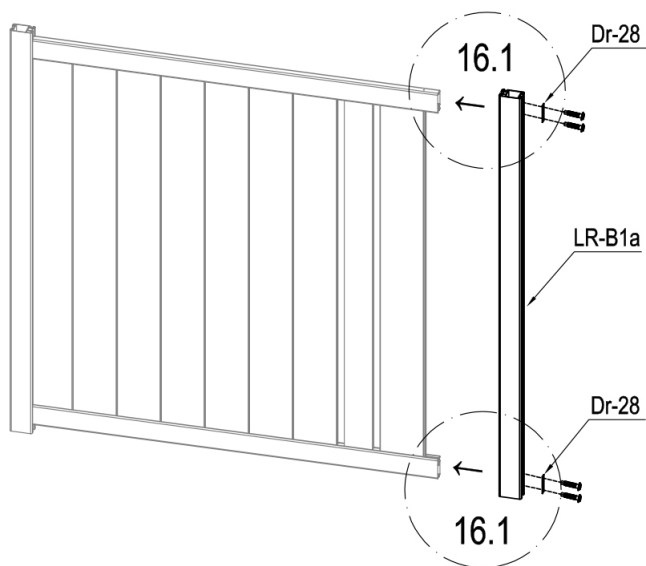

	LR-E4a	1
	LR-D6	4

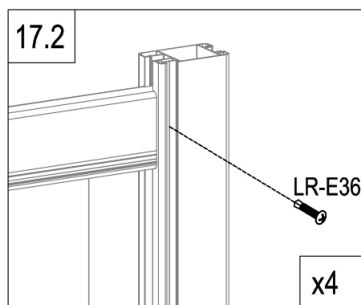
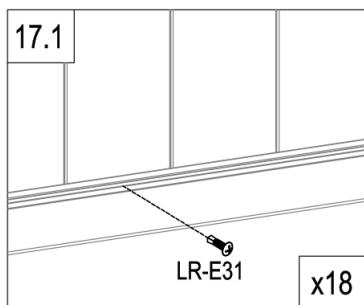
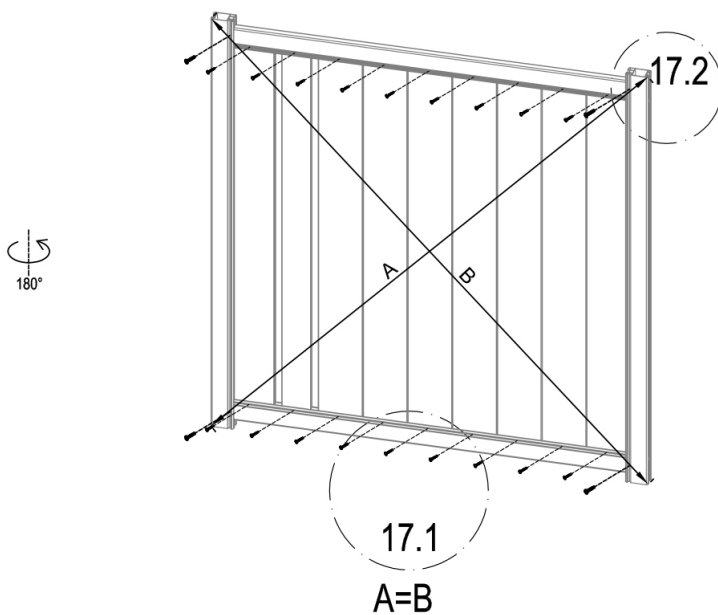

	LR-B1a	1
	Dr-28	2
	LR-E33	4



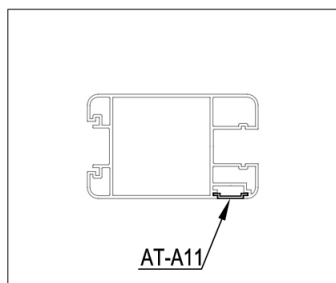
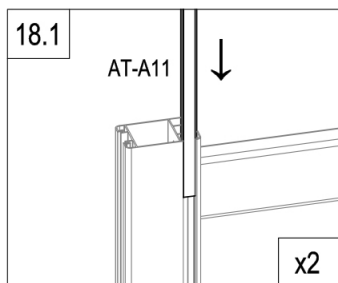
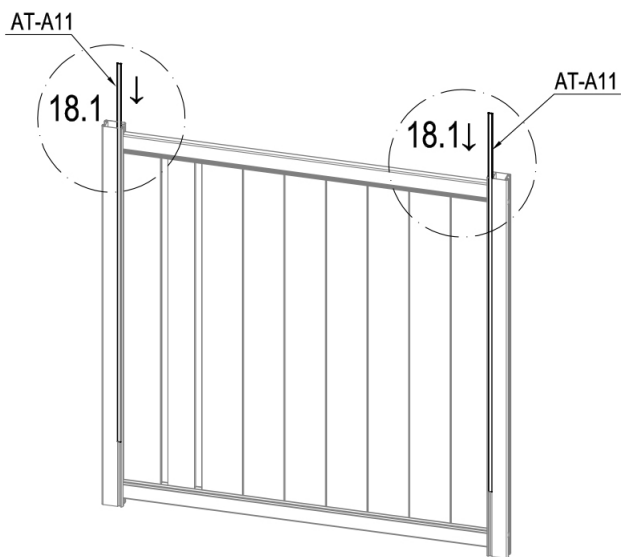

	LR-E31	18
	LR-E36	4



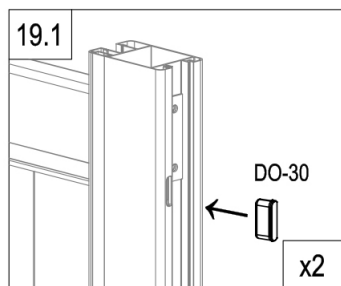
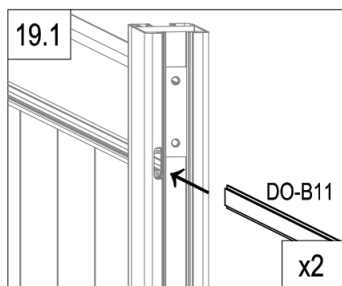
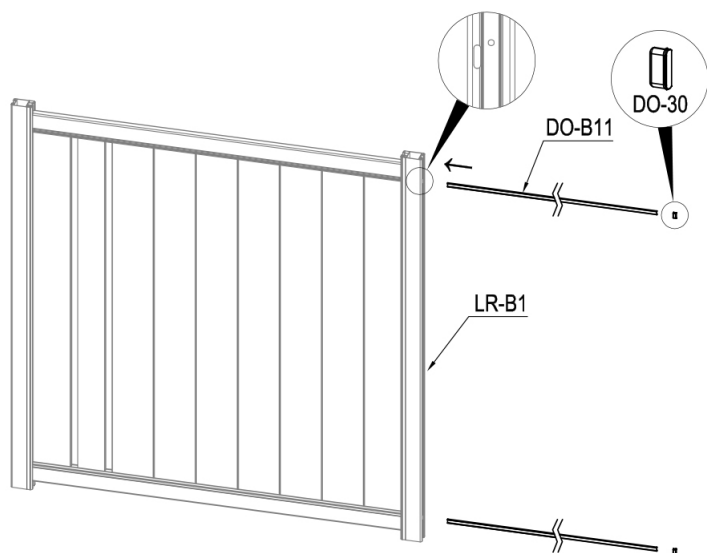

	AT-A11	2
---	--------	---

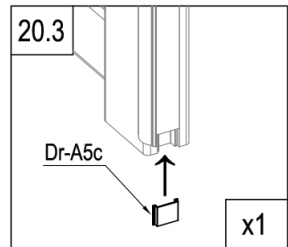
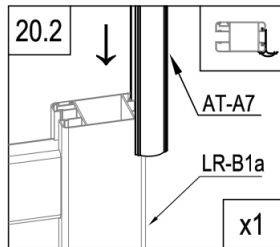
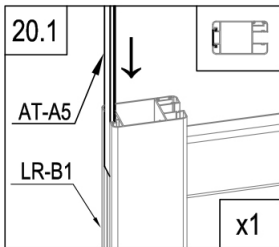
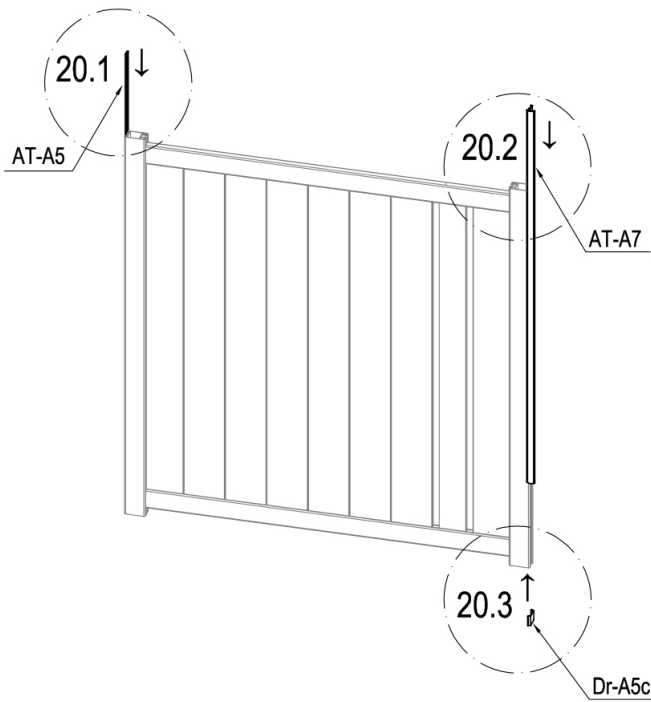

	DO-B1	2
	DO-30	2



	AT-A5	1
	Dr-A5c	1
	AT-A7	1

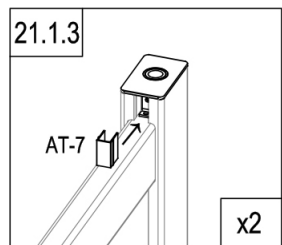
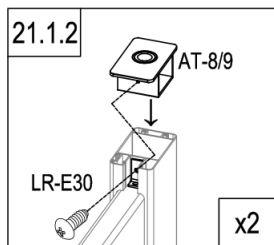
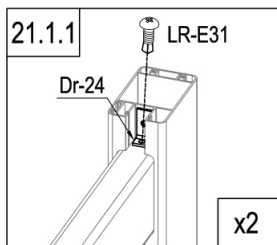
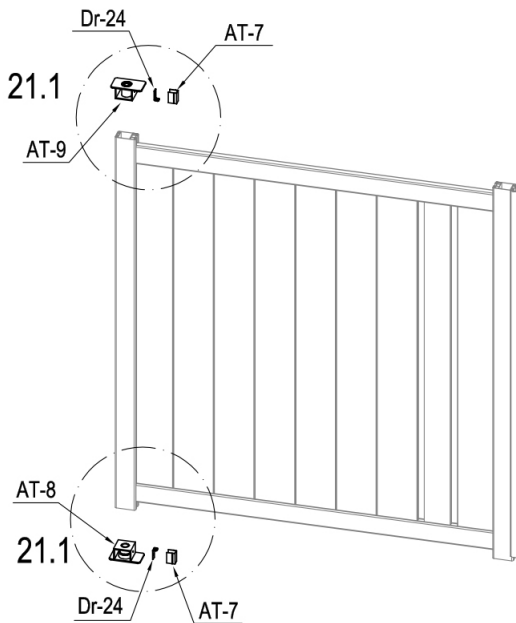

	AT-8	1
	AT-9	1
	Dr-24	2

	AT-7	2
	LR-E30	2
	LR-E31	2

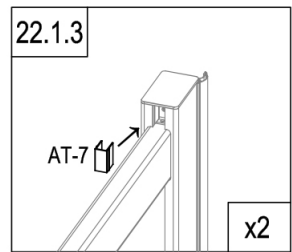
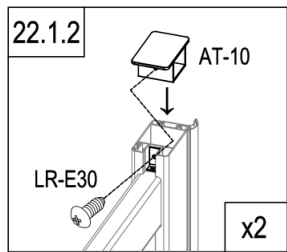
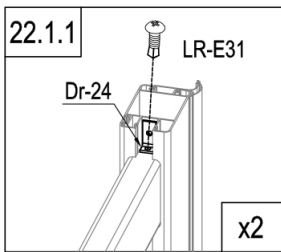
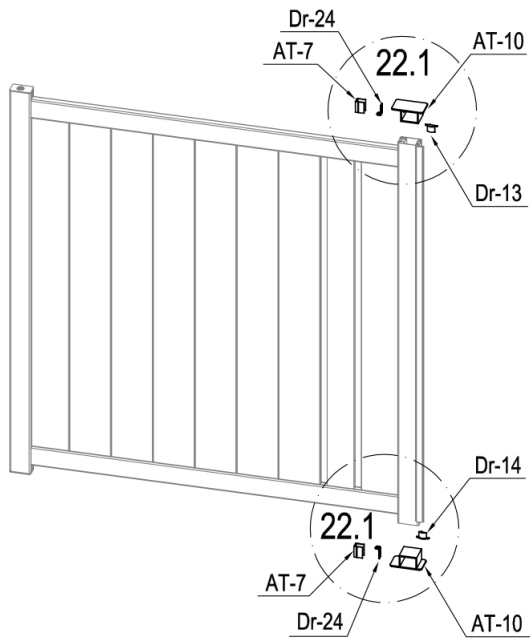

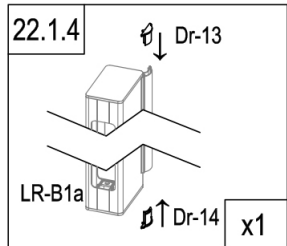

	AT-10	2
	Dr-24	2
	AT-7	2
	Dr-13	1



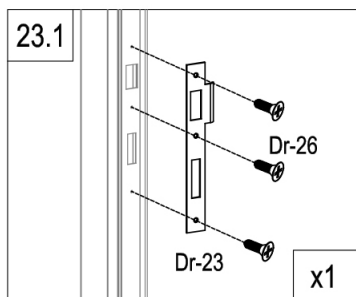
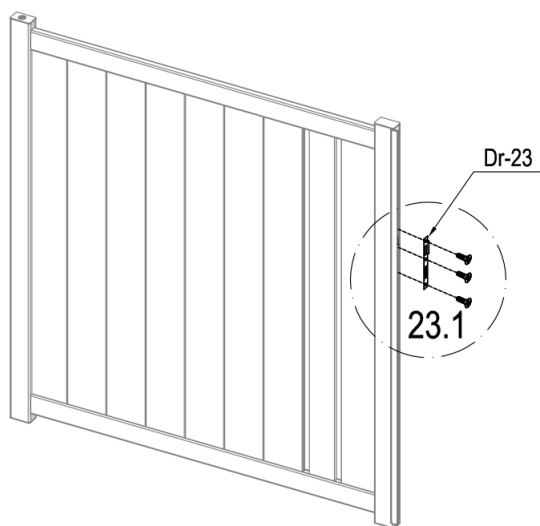

	Dr-14	1
	LR-E30	2
	LR-E31	2



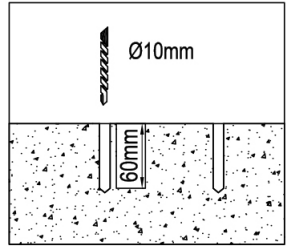
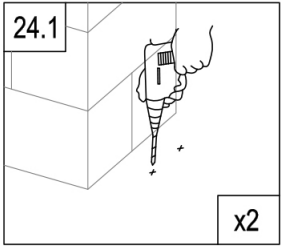
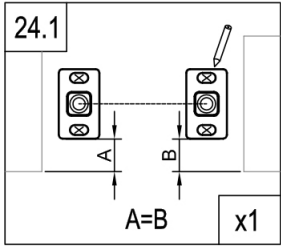
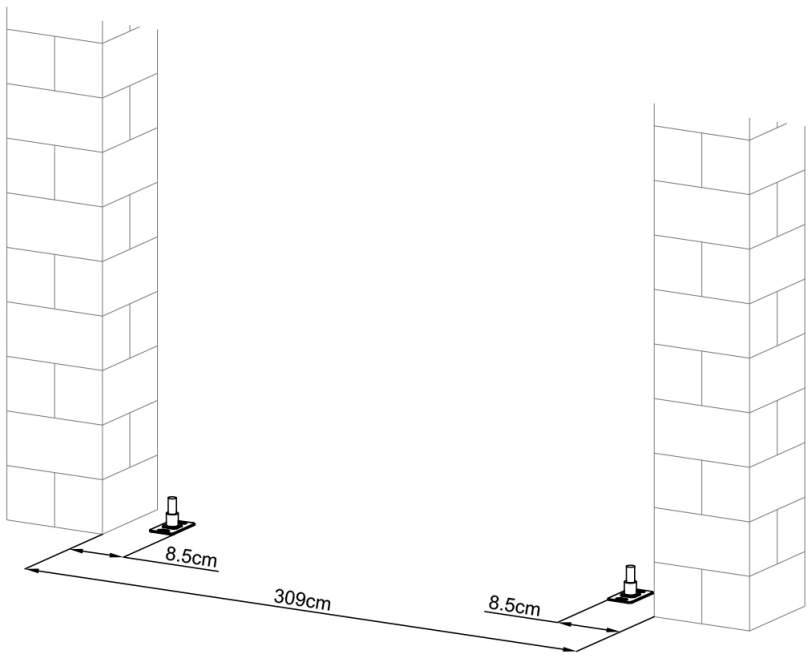

	Dr-23	1
	Dr-26	3



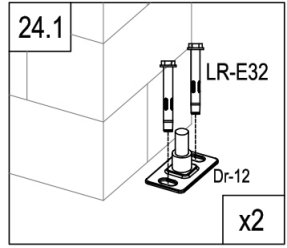

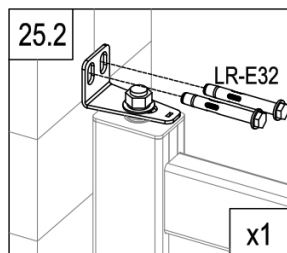
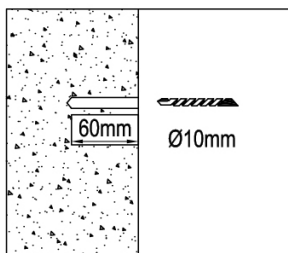
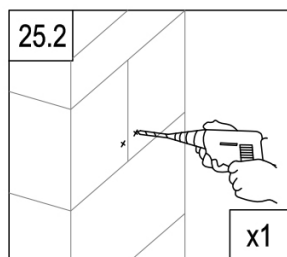
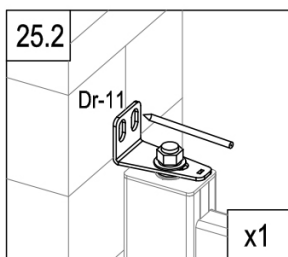
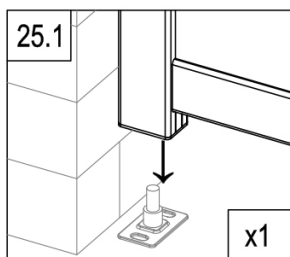
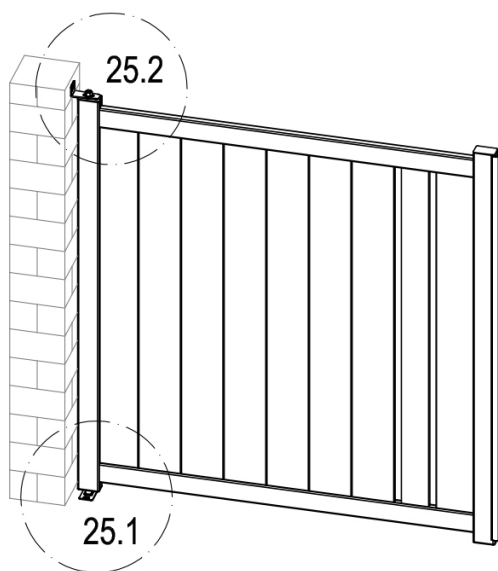
	Dr-12	2
	LR-E32	4



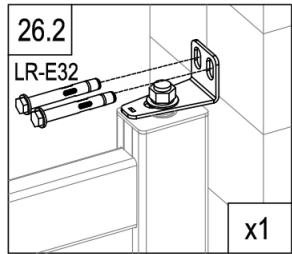
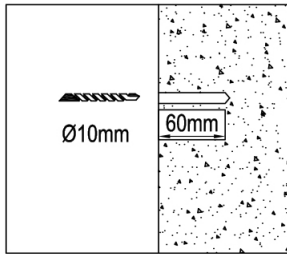
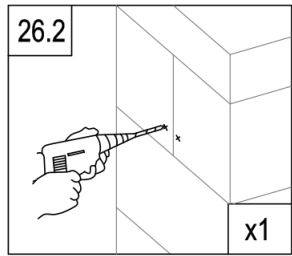
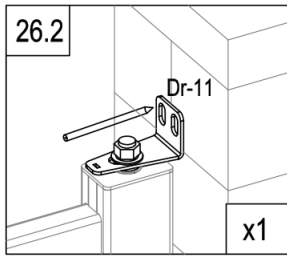
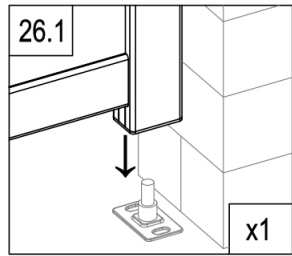
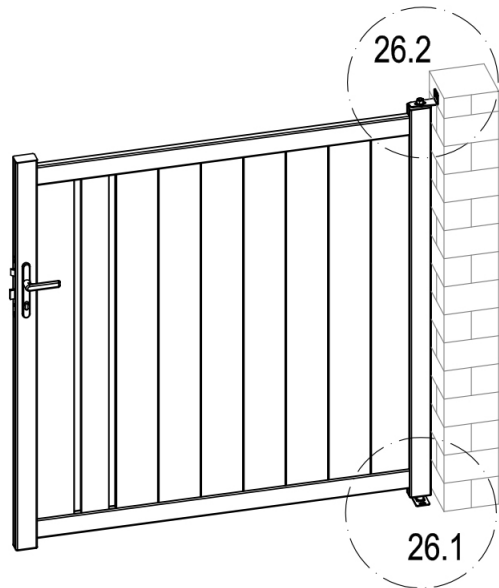

	Dr-11	1
	LR-E32	2





	Dr-11	1
	LR-E32	2

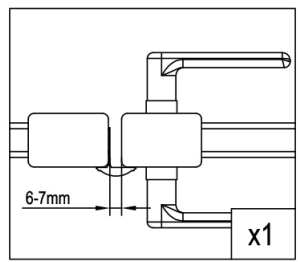
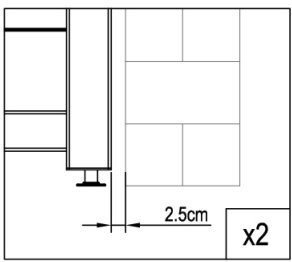
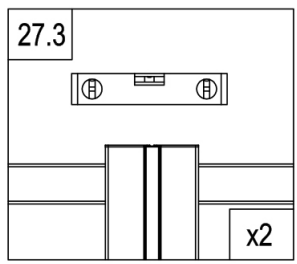
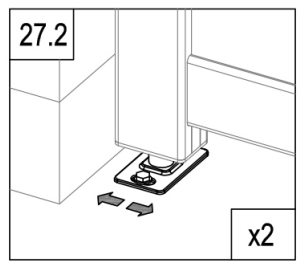
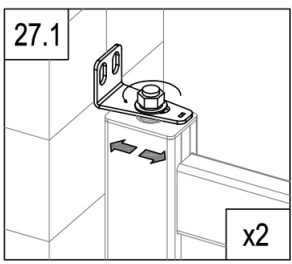
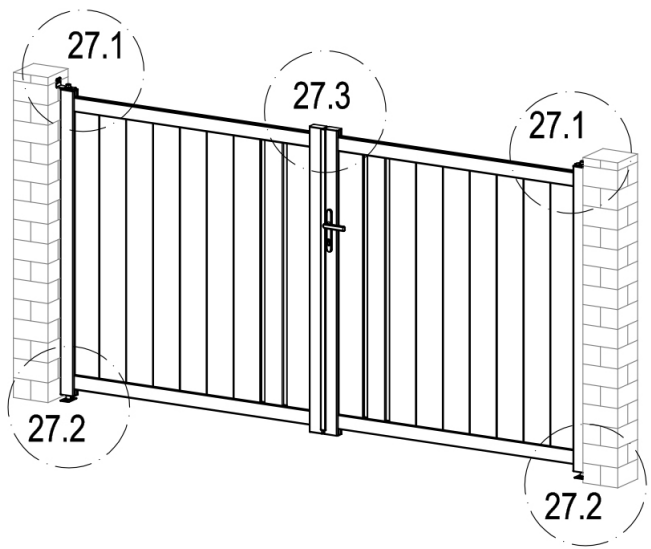

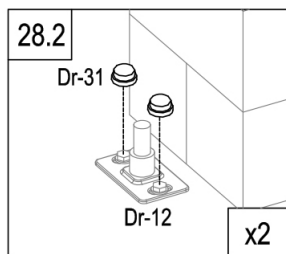
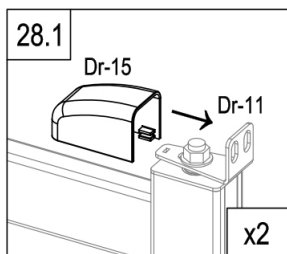
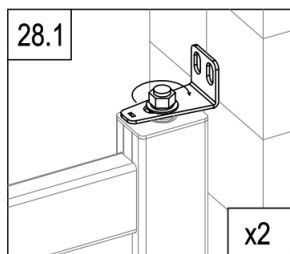
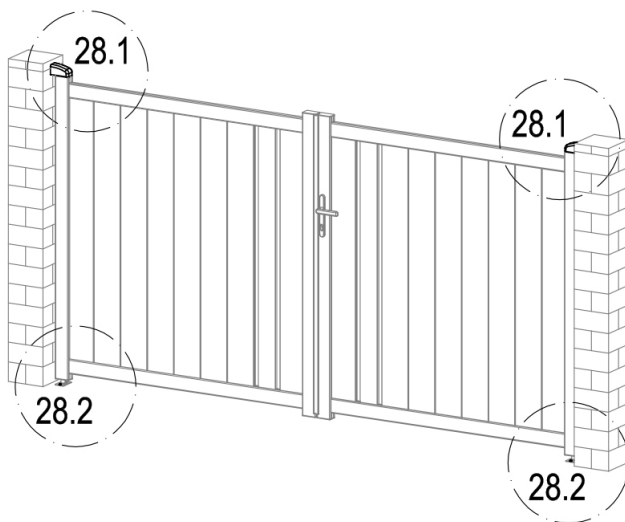
CASANOVO



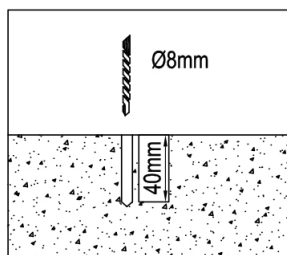
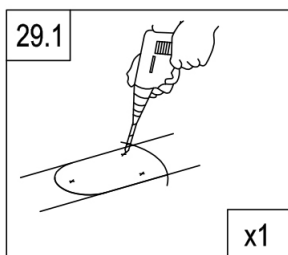
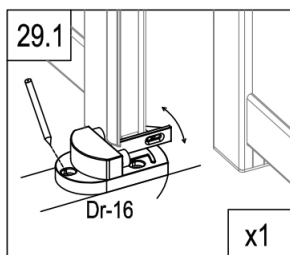
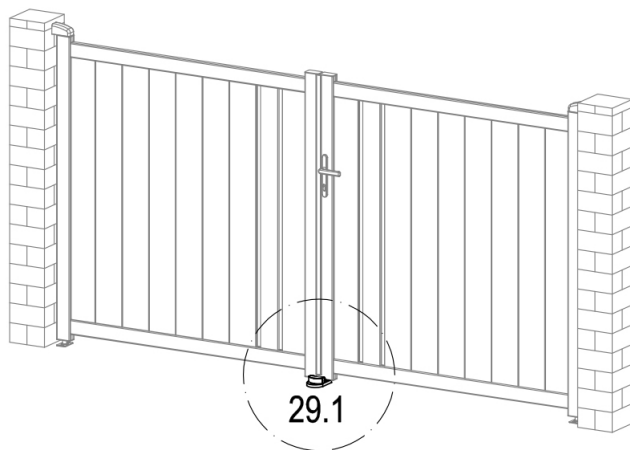

	Dr-15	2
	Dr-31	4



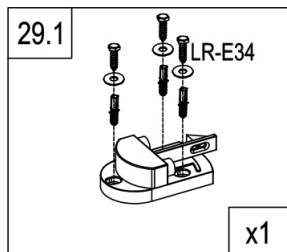

	Dr-16	1
	LR-E34	3
	LR-E35	3

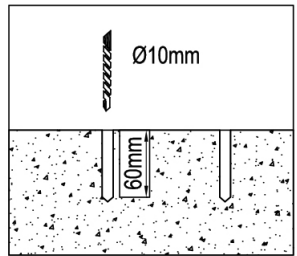
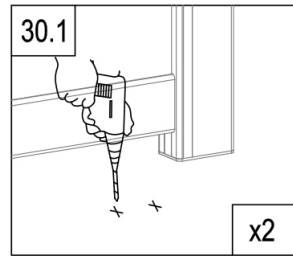
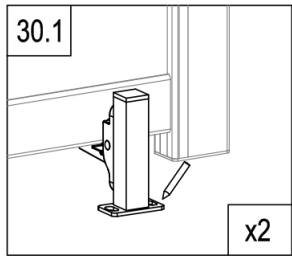
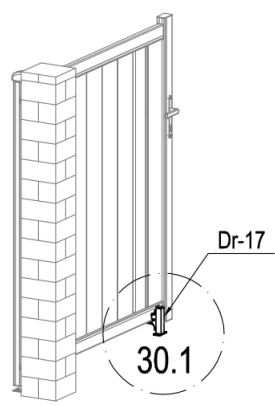
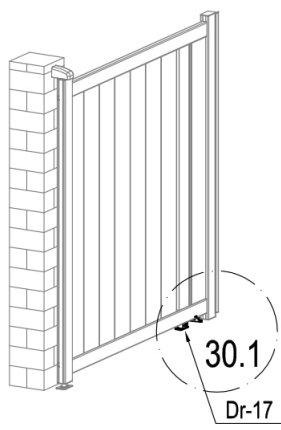

CASANOVO



	LR-E32	4
	Dr-17	2

