

CASANOVO

GIONA 300B120

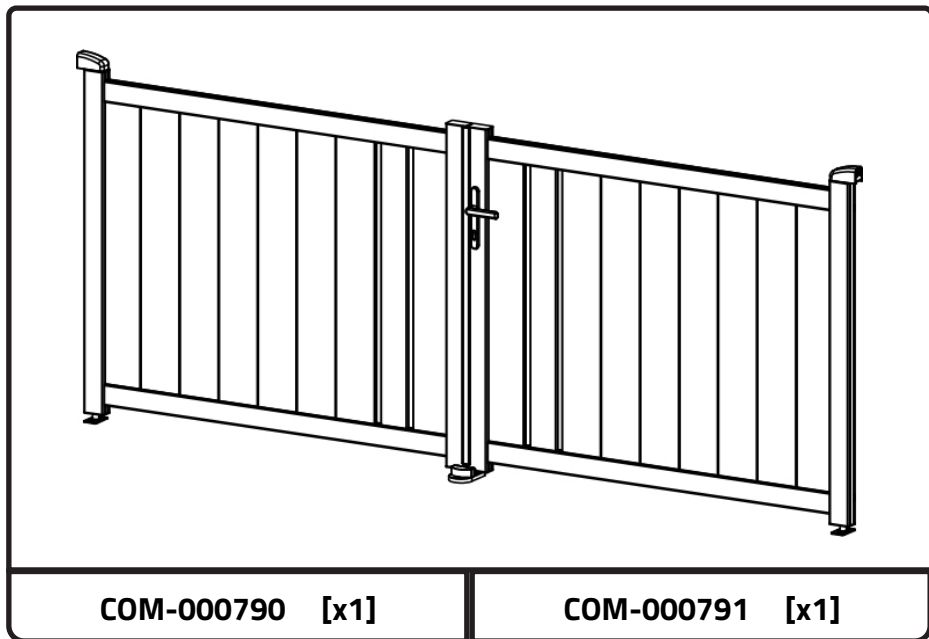

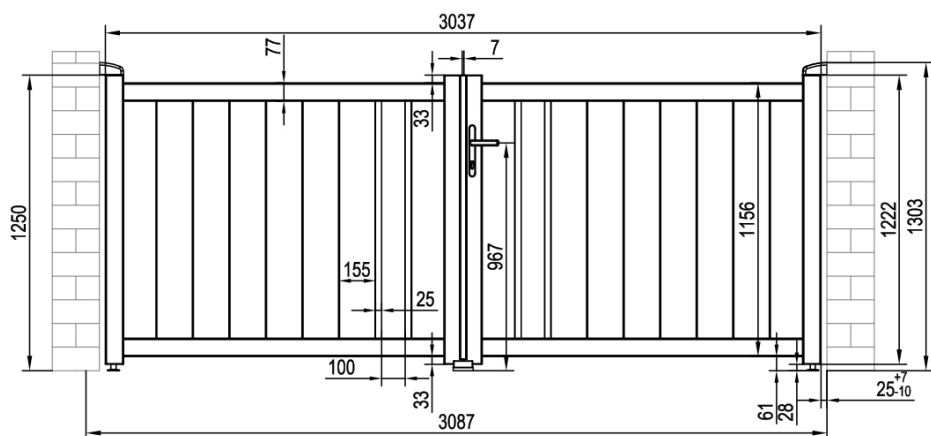



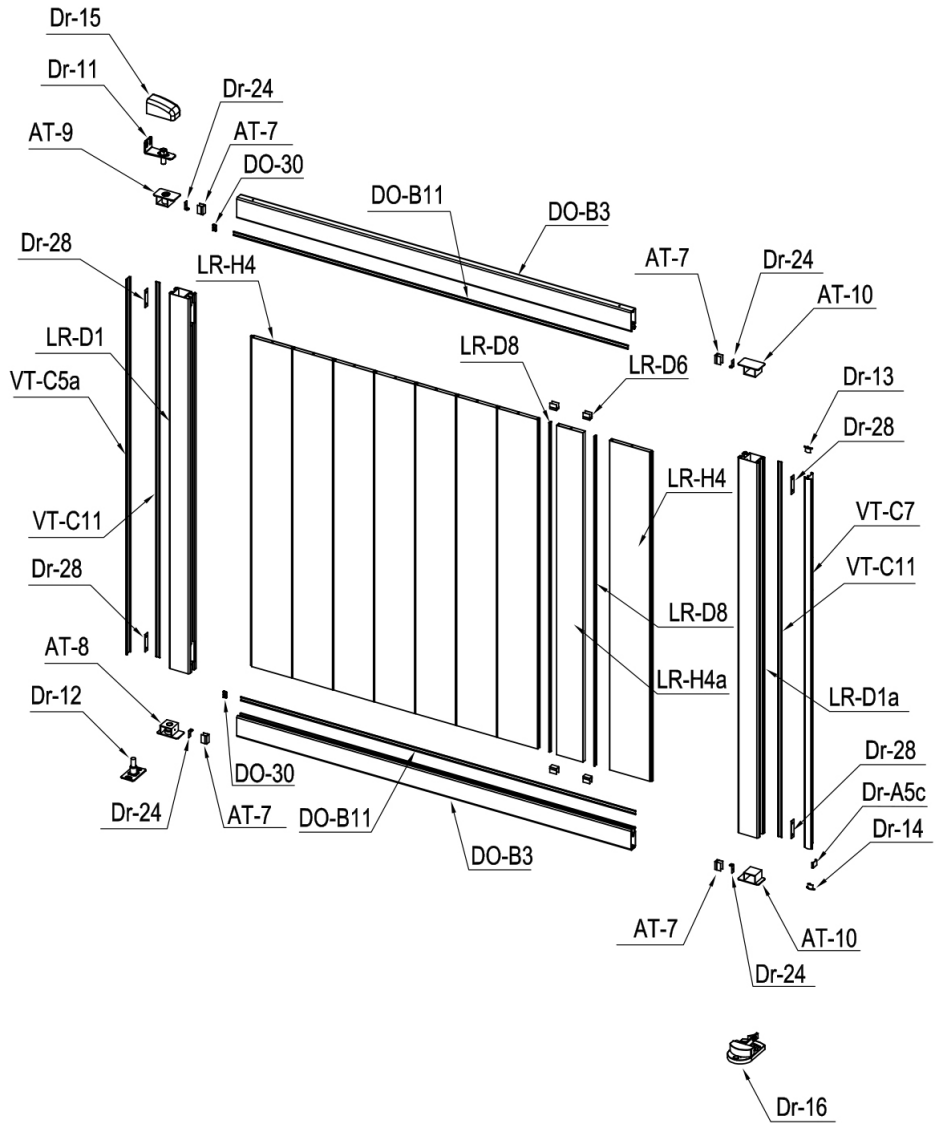

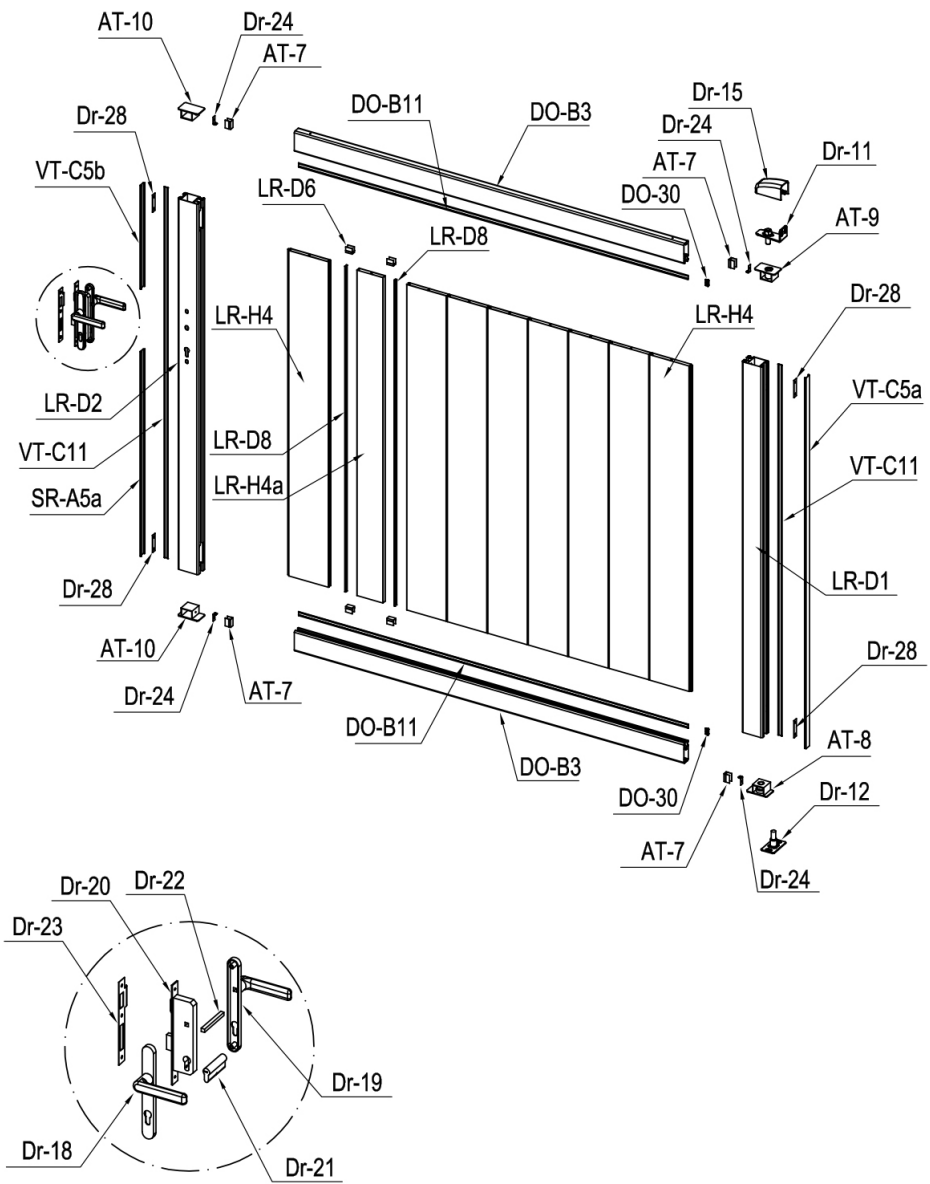

































INSTRUCTION MANUAL / NOTICE DE MONTAGE / MONTAGEANLEITUNG / MANUAL DE MONTAJE / MANUAL DE MONTAGEM / MANUALE DI MONTAGGIO /
MONTAGEHANDLEIDING / INSTRUKCJA MONTAŻU / KÄYTTÖOHJEET / BRUGSANVISNING / BRUGSANVISNING / INSTRUCȚIUNI DE ASAMBLARE /
NAVODILA ZA SESTAVLJANJE / NÁVOD NA MONTÁŽ / ÖSSZESZERELÉSI ÚTMUTATÓ / NÁVOD K MONTÁŽI / UPUTE ZA INSTALACIJU /
ΟΔΗΓΙΕΣ ΣΥΝΑΡΜΟΛΟΓΗΣΗΣ / SURINKIMO INSTRUKCIJOS / MONTĀŽAS INSTRUKCIJAS









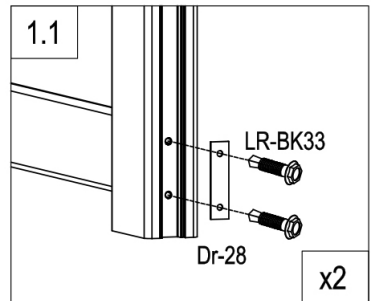
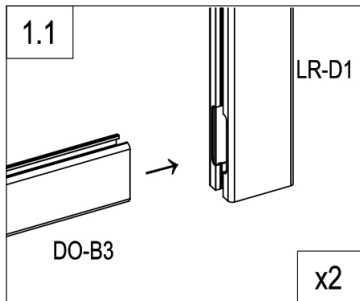
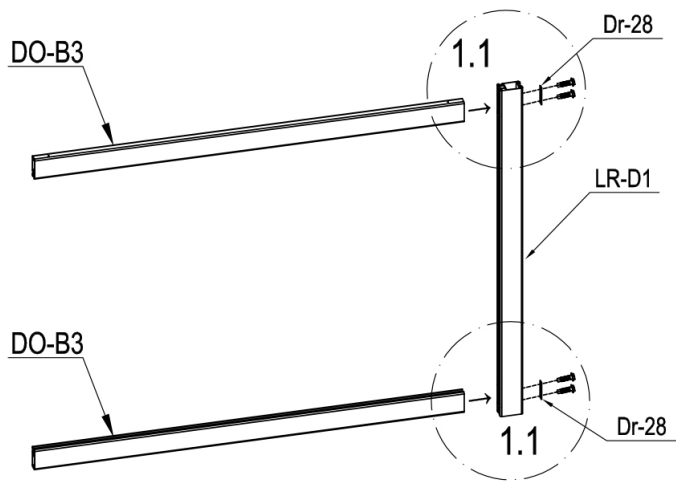

CASANOVO



IMAGE	NO.	L.(mm)	QTY	IMAGE	NO.	L.(mm)	QTY
	LR-D1	1217	2		Dr-17		2
	LR-D1a	1217	1		Dr-31		4
	LR-D2	1217	1		DO-30		4
	DO-B3	1492	4		Dr-18		1
	LR-H4	1044	16		Dr-19		1
	LR-H4a	1044	2		Dr-20		1
	VT-C5a	1217	2		Dr-21		1
	VT-C5b	194.5	1		Dr-22		1
	SR-A5a	782	1		Dr-23		1
	Dr-A5c	19.5	1		Dr-25		1
	VT-C11	1217	4		Dr-25a		2
	DO-B11	1492	4		Dr-26		3
	AT-7	29.5	8		Dr-27		2
	LR-D6	25	8		Dr-24		8
	LR-D8	1044	4		Dr-28		8
	VT-C7	1197	1		LR-BK30		8
	AT-8		2		LR-BK31		44
	AT-9		2		LR-BK32		12
	AT-10		4		LR-BK33		16
	Dr-11		2		LR-BK34		3
	Dr-12		2		LR-BK35		3
	Dr-13		1		LR-BK36		8
	Dr-14		1				
	Dr-15		2				
	Dr-16		1				



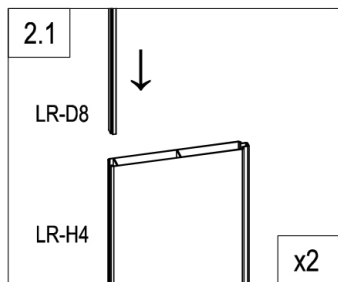
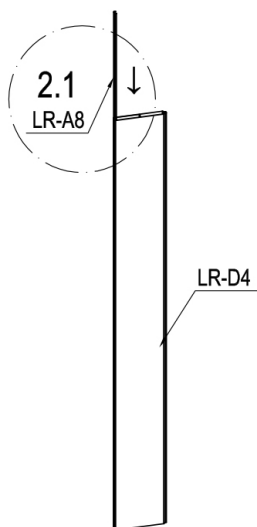

	LR-D1	1
	DO-B3	2
	Dr-28	2
	LR-BK33	4



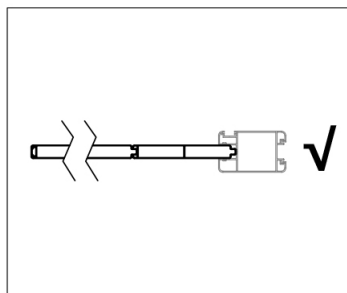
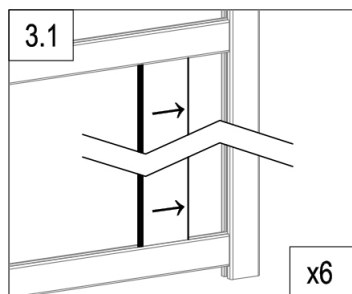
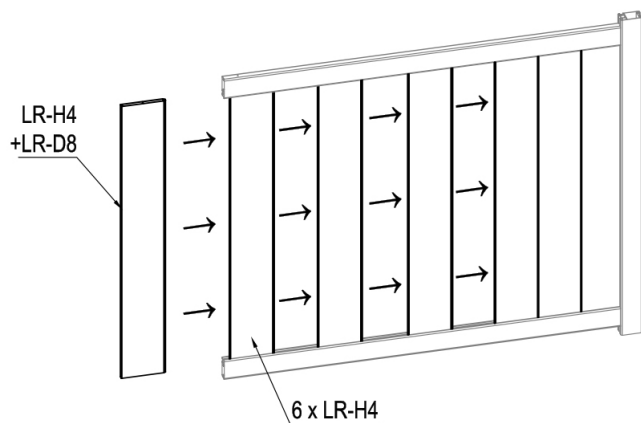

X2

	LR-D8	2
	LR-H4	2



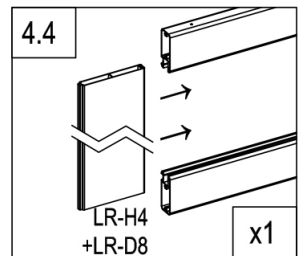
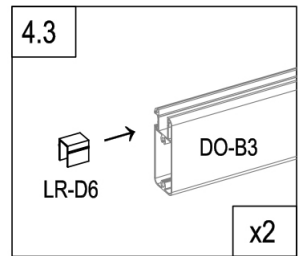
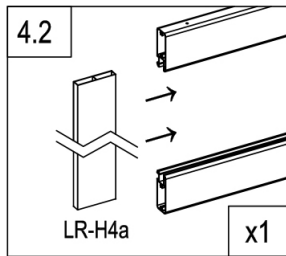
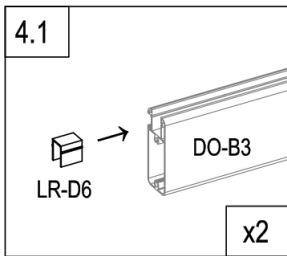
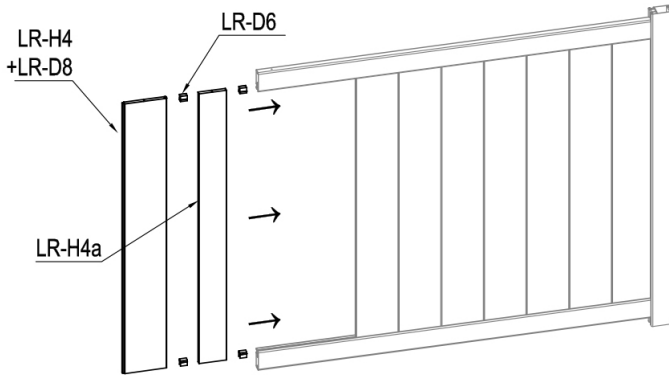

	LR-H4	6
---	-------	---



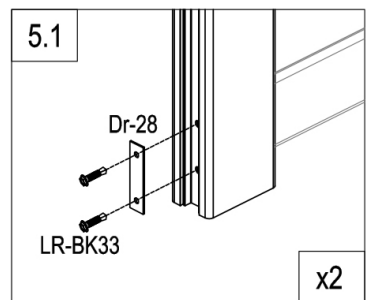
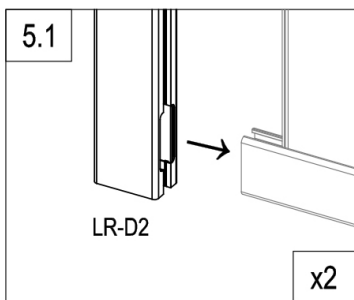
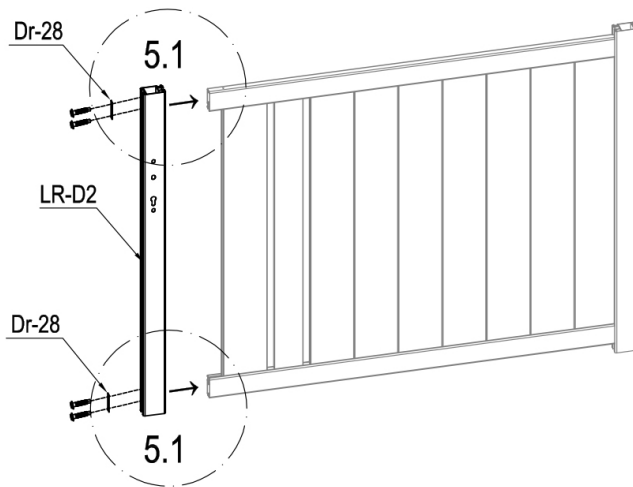

	LR-H4a	1
	LR-D6	4

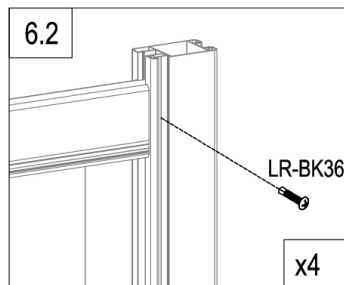
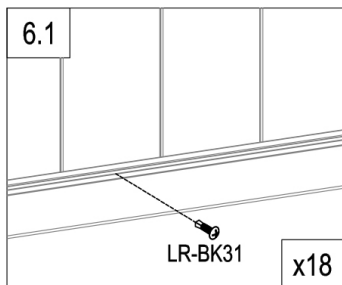
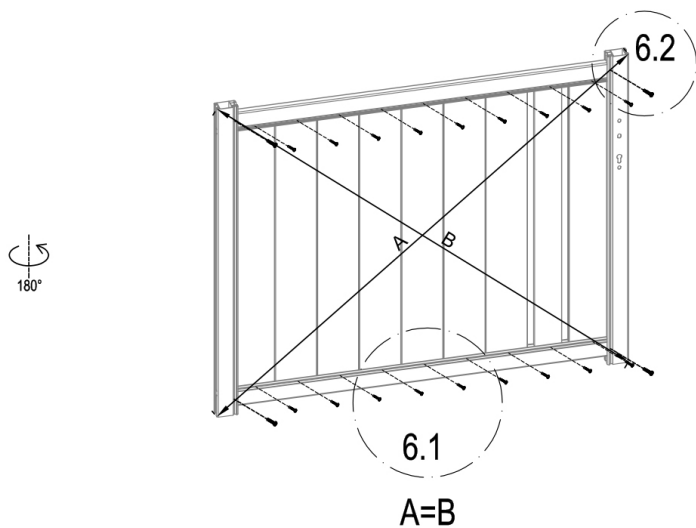

	LR-D2	1
	Dr-28	2
	LR-BK33	4



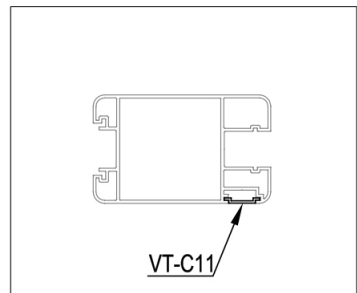
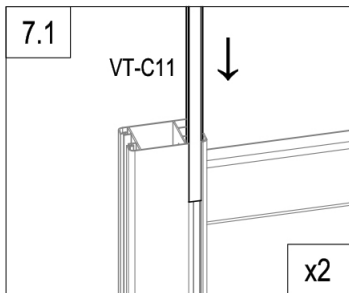
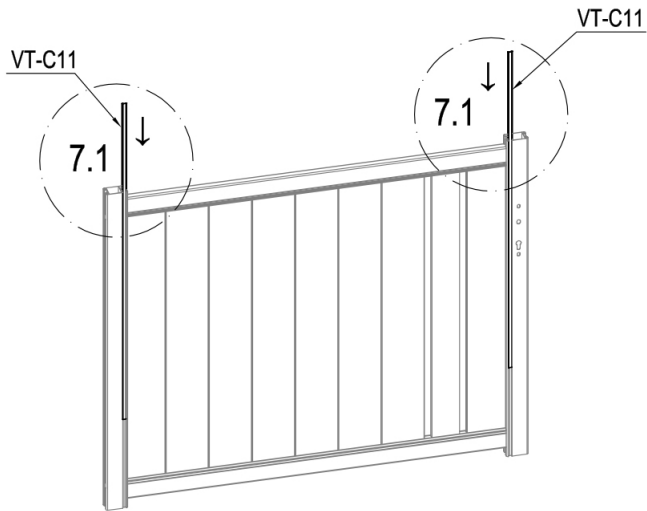

	LR-BK31	18
	LR-BK36	4

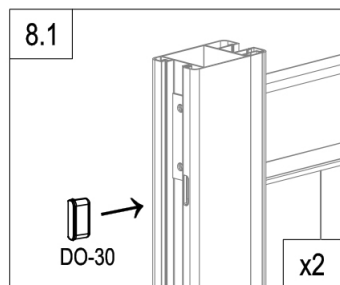
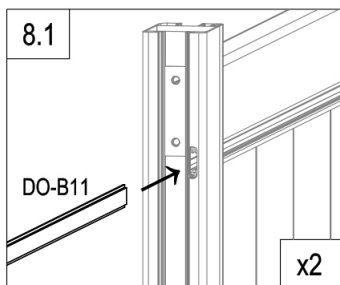
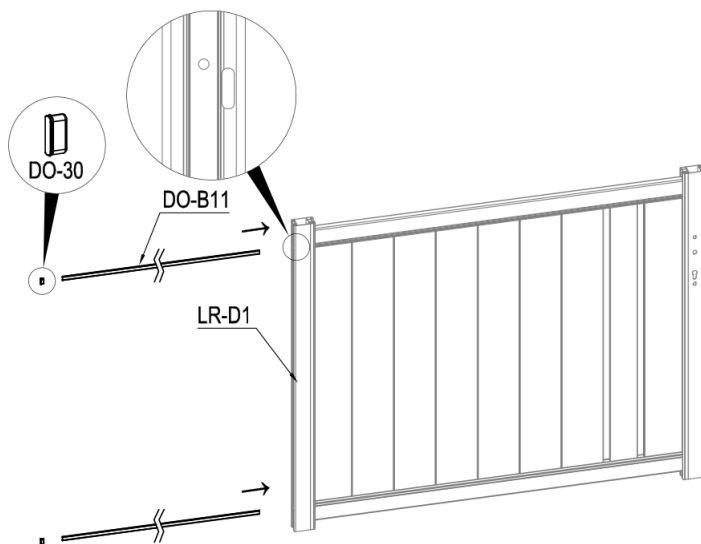

	VT-C11	2
---	--------	---



	DO-B11	2
	DO-30	2

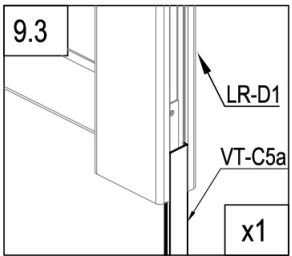
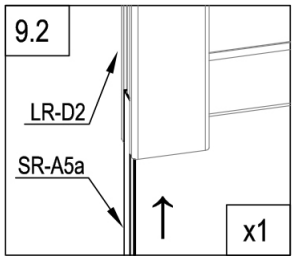
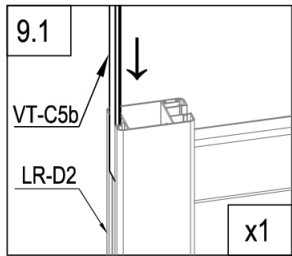
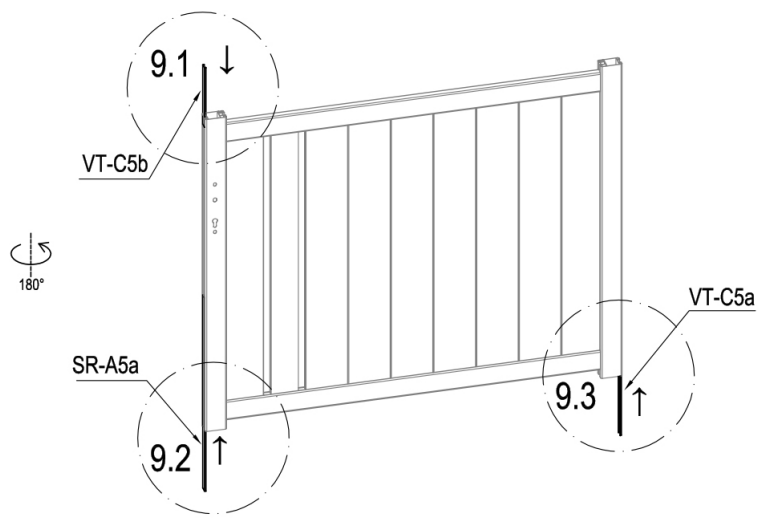

	VT-C5a	1
	VT-C5b	1
	SR-A5a	1

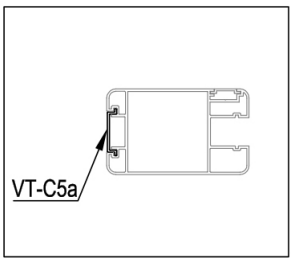

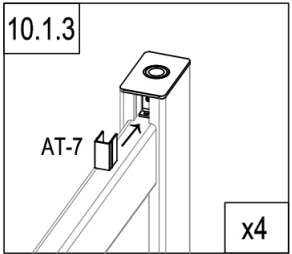
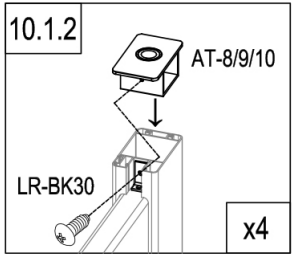
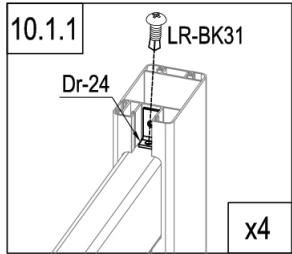
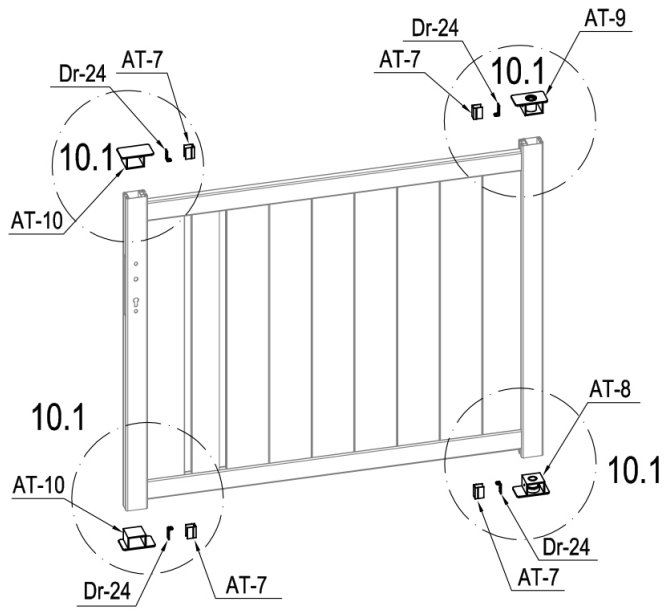

	AT-8	1
	AT-9	1
	AT-10	2
	Dr-24	4



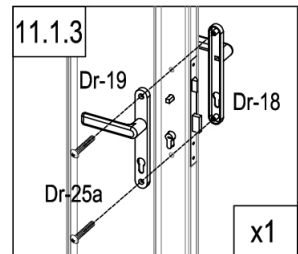
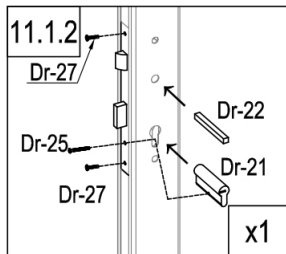
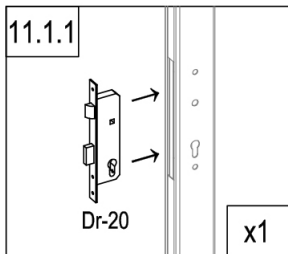
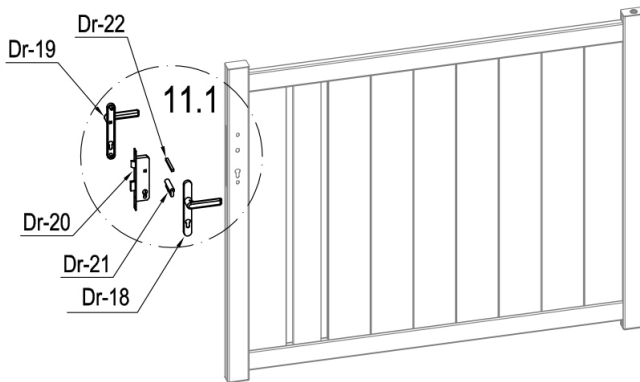

	AT-7	4
	LR-BK30	4
	LR-BK31	4

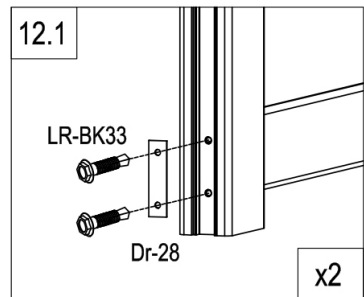
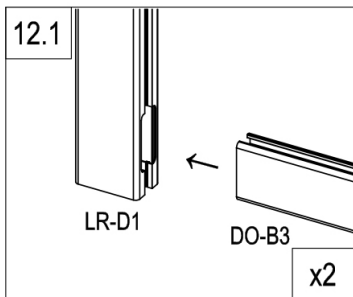
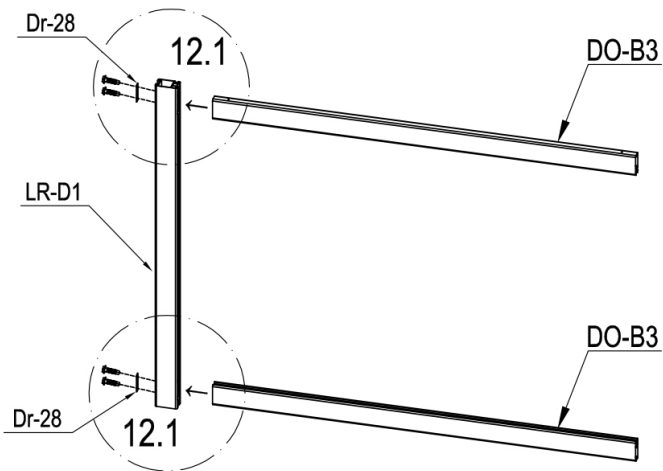

	Dr-20	1
	Dr-21	1
	Dr-22	1
	Dr-25	1



	Dr-18	1
	Dr-19	1
	Dr-25a	2
	Dr-27	2



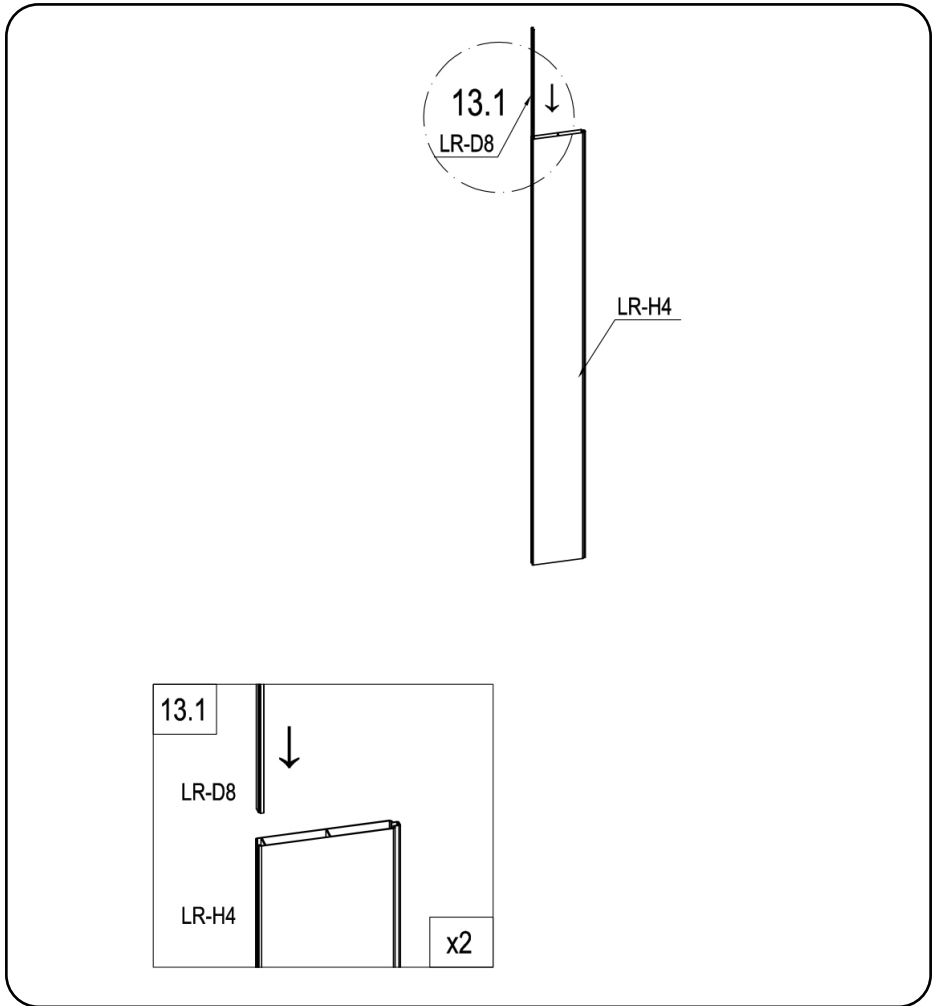

	LR-D1	1
	DO-B3	2
	Dr-28	2
	LR-BK33	4



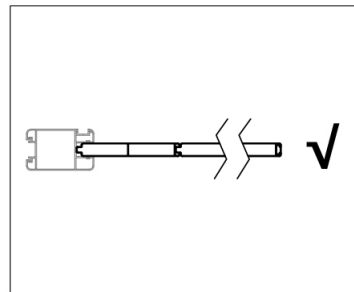
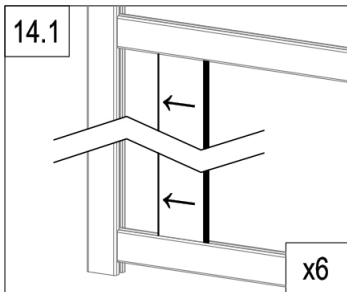
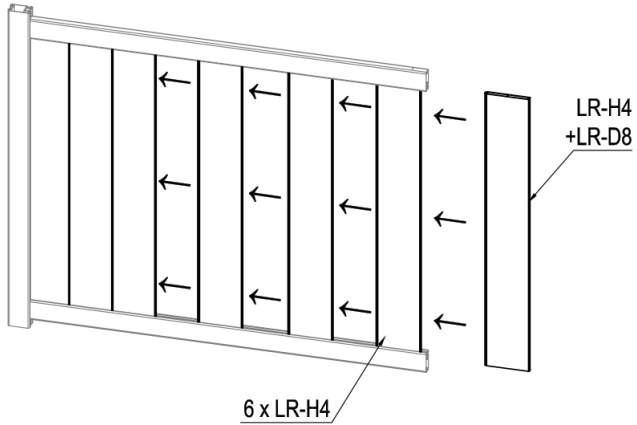

X2

	LR-D8	2
	LR-H4	2



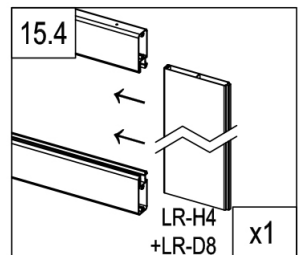
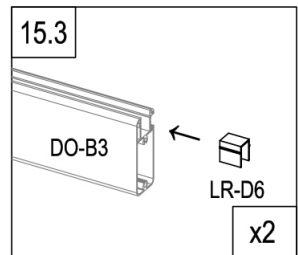
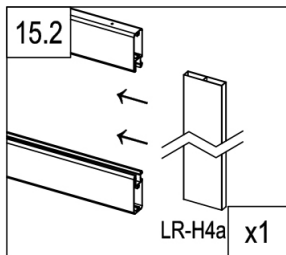
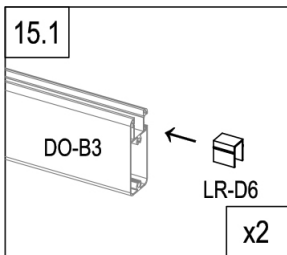
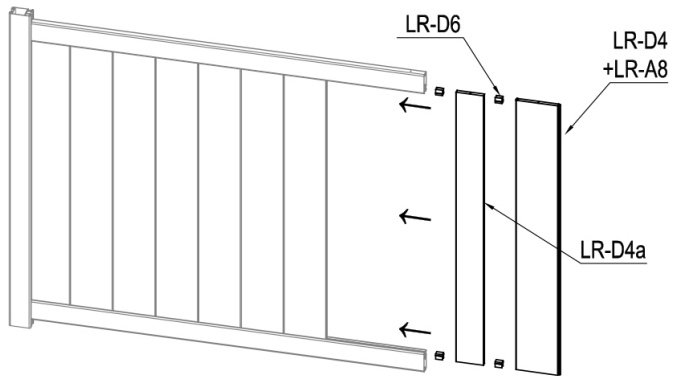

	LR-H4	6
---	-------	---



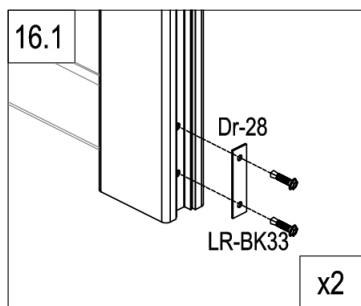
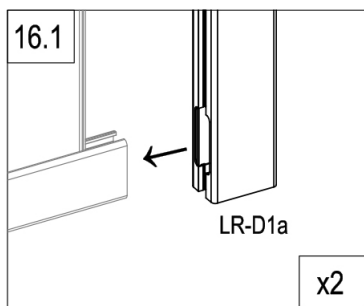
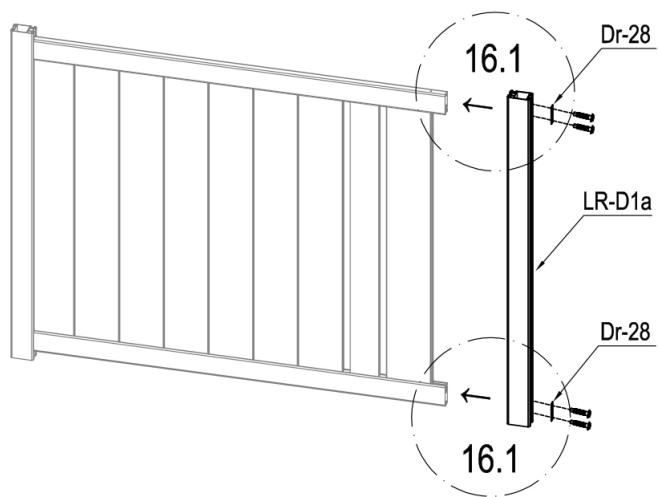

	LR-H4a	1
	LR-D6	4

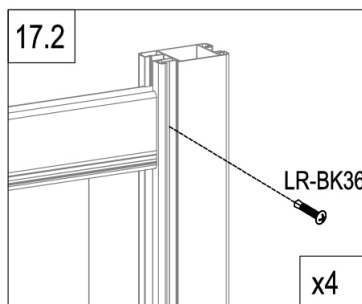
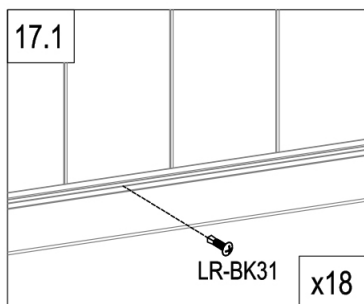
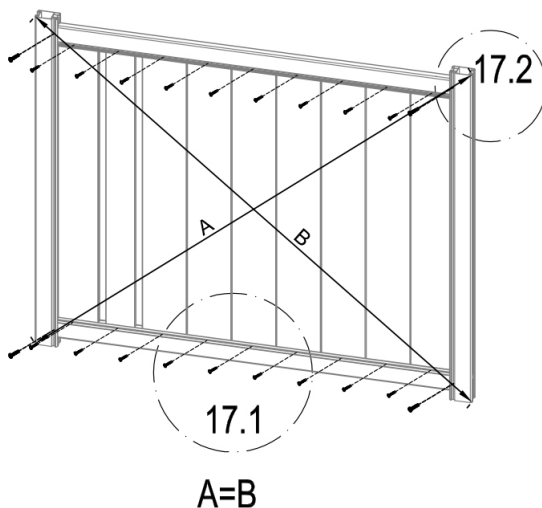

	LR-D1a	1
	Dr-28	2
	LR-BK33	4



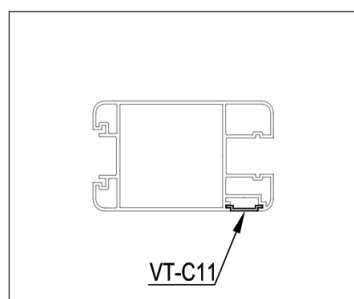
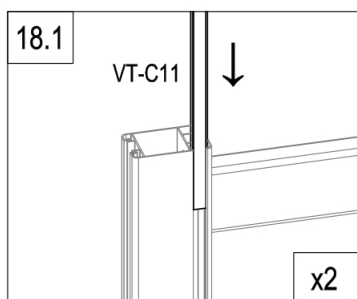
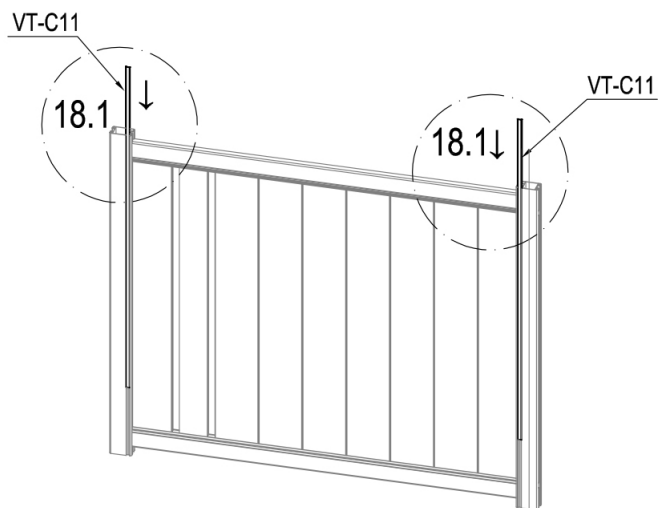

	LR-BK31	18
	LR-BK36	4



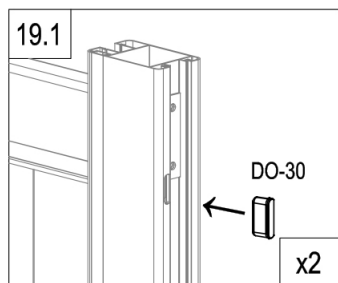
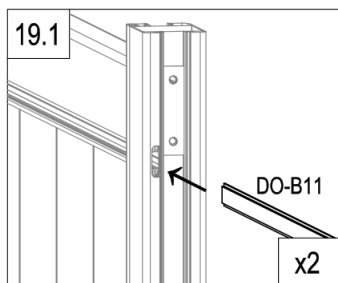
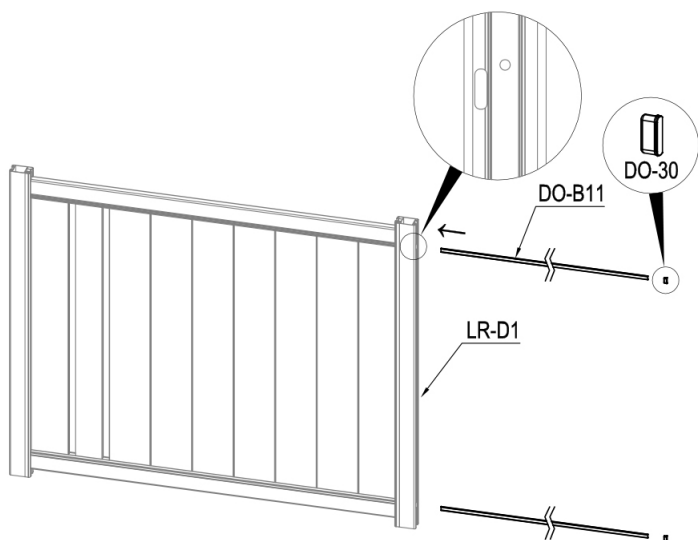

	VT-C11	2
---	--------	---

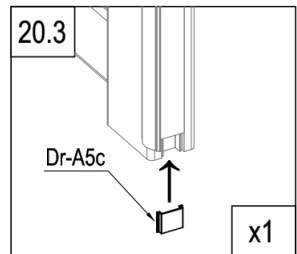
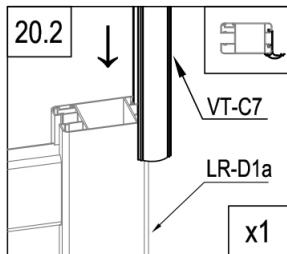
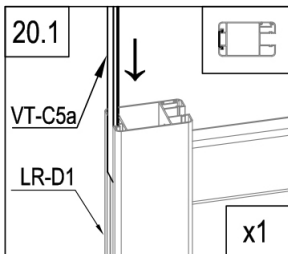
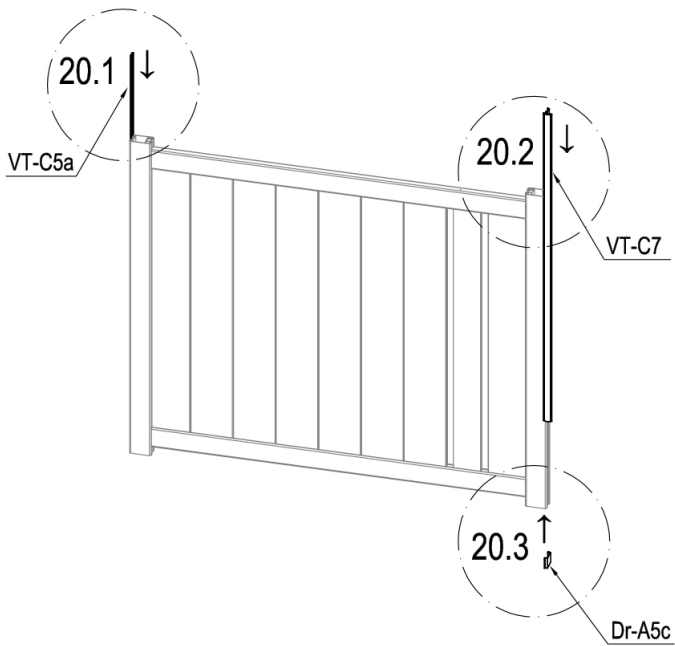

	DO-B11	2
	DO-30	2



	VT-C5a	1
	Dr-A5c	1
	VT-C7	1

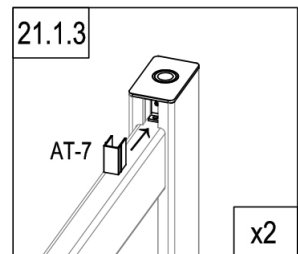
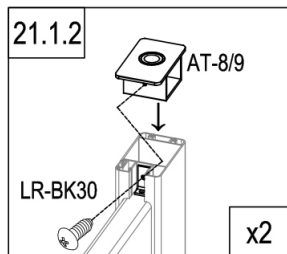
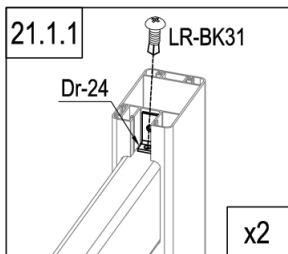
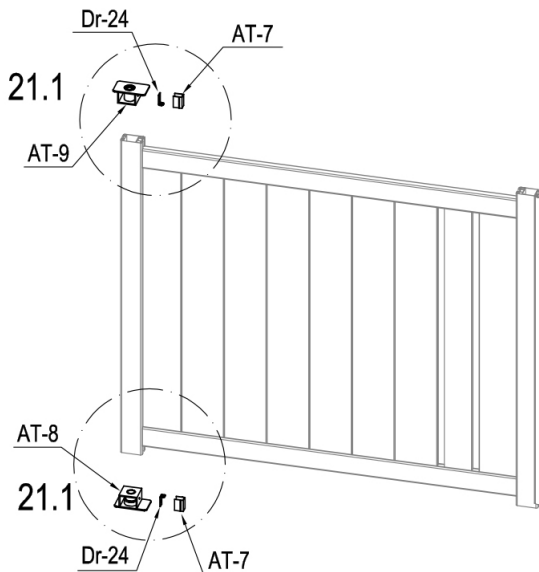

	AT-8	1
	AT-9	1
	Dr-24	2

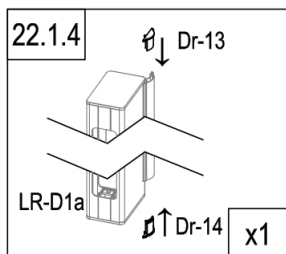
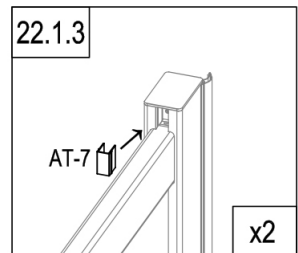
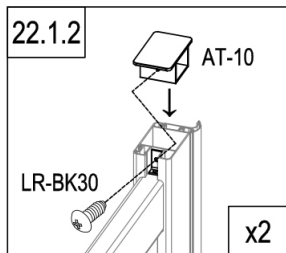
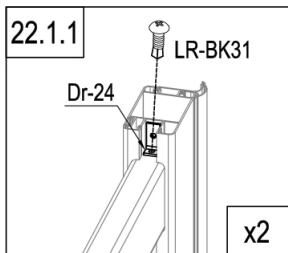
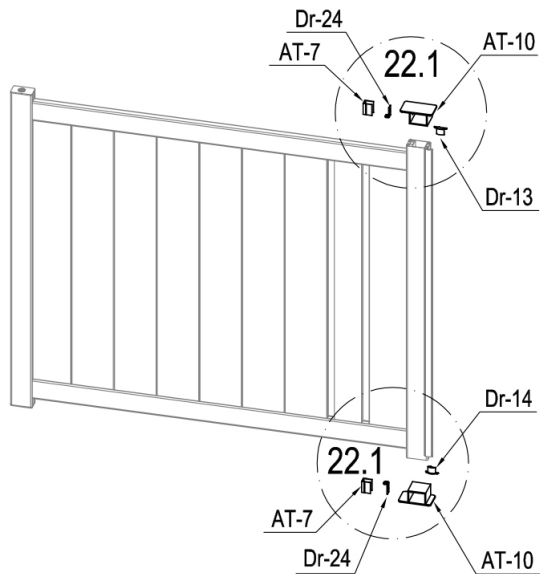

	AT-7	2
	LR-BK30	2
	LR-BK31	2



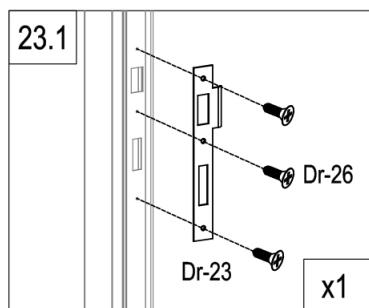
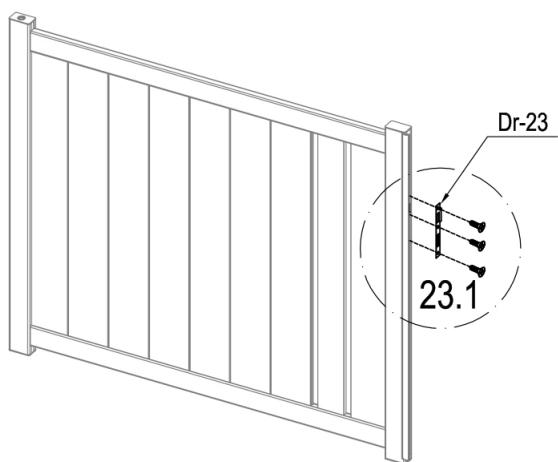

	AT-10	2
	Dr-24	2
	AT-7	2
	Dr-13	1

	Dr-14	1
	LR-BK30	2
	LR-BK31	2



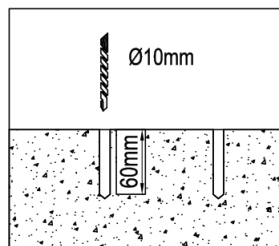
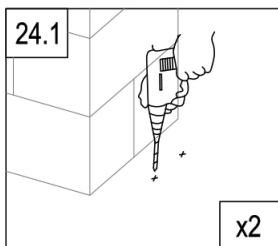
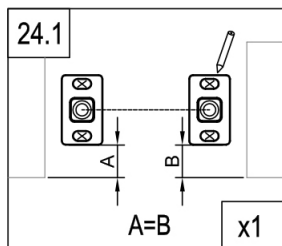
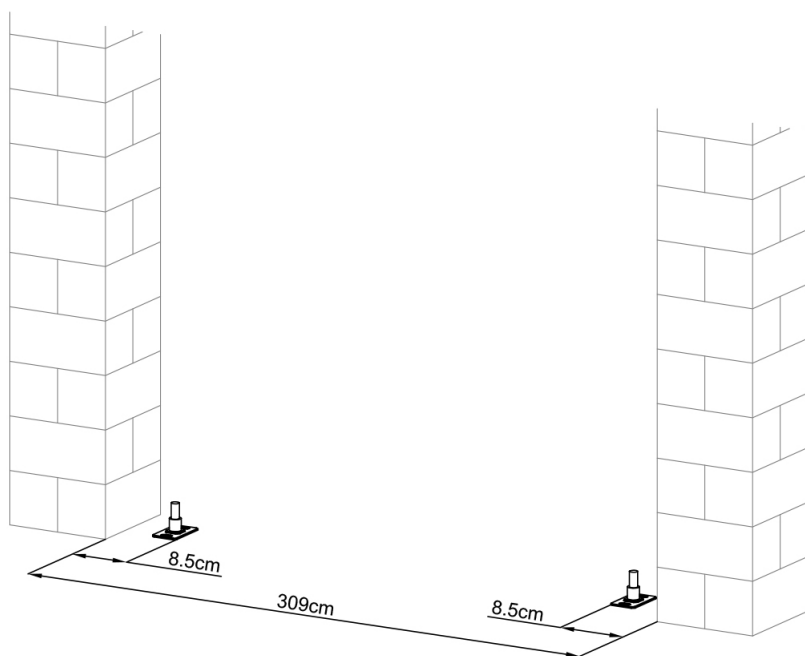

	Dr-23	1
	Dr-26	3



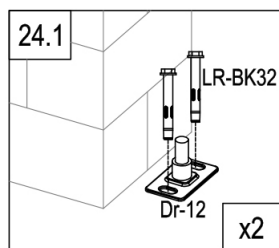

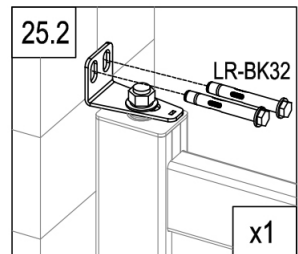
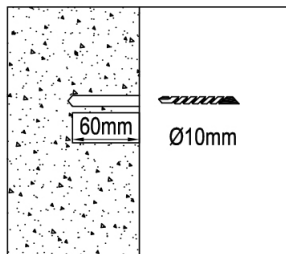
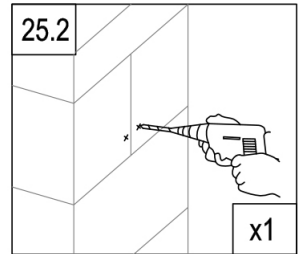
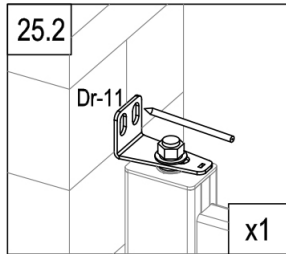
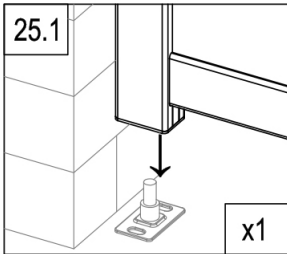
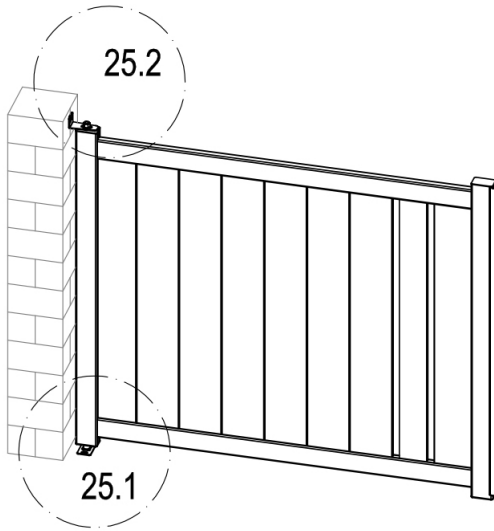
	Dr-12	2
	LR-BK32	4





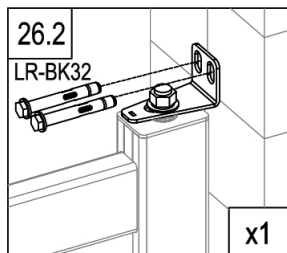
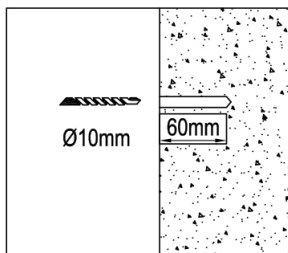
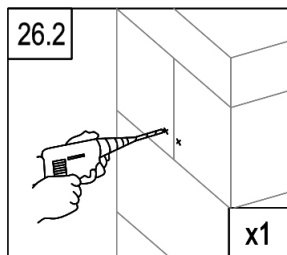
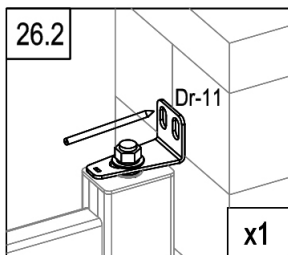
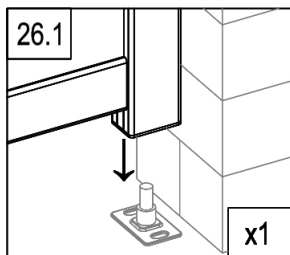
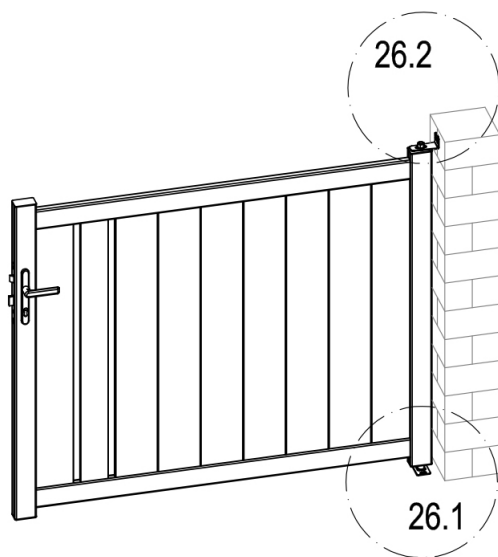

	Dr-11	1
	LR-BK32	2



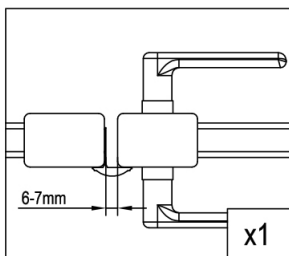
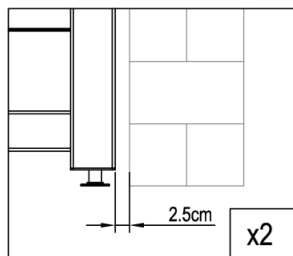
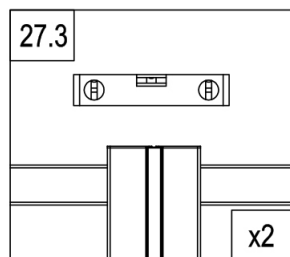
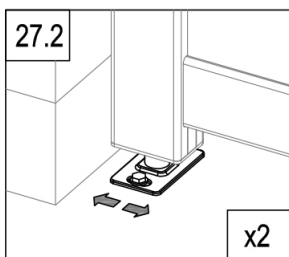
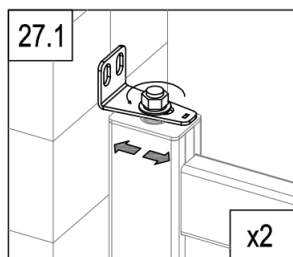
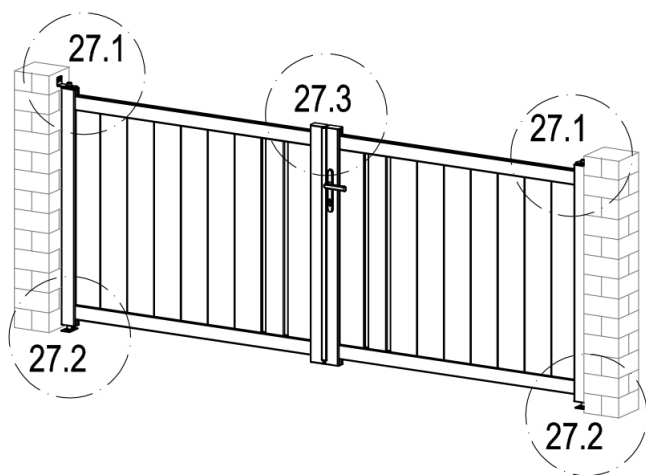

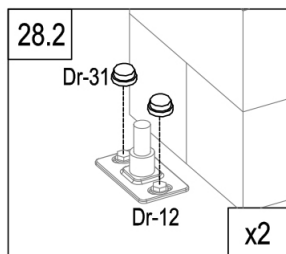
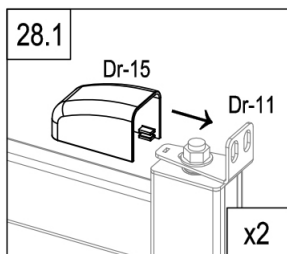
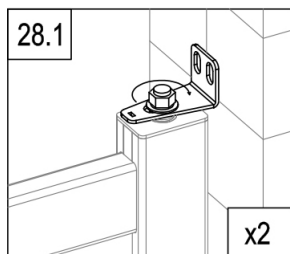
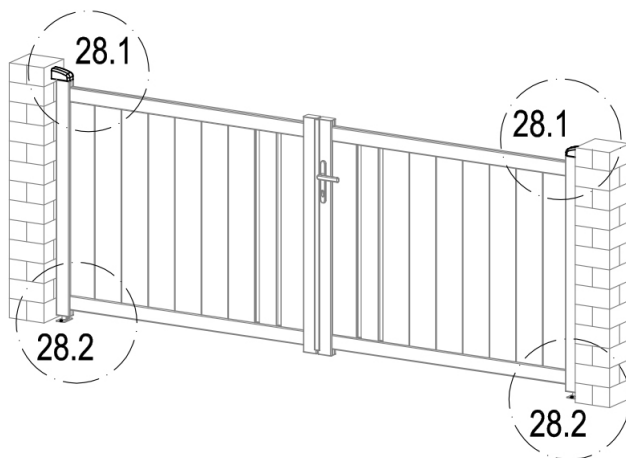

	Dr-11	1
	LR-BK32	2



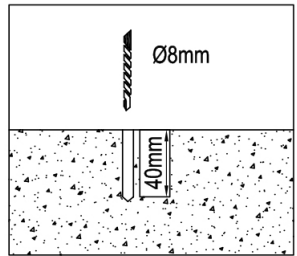
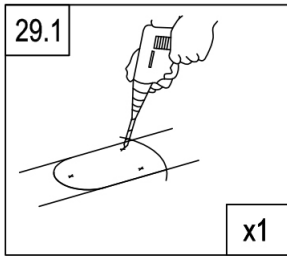
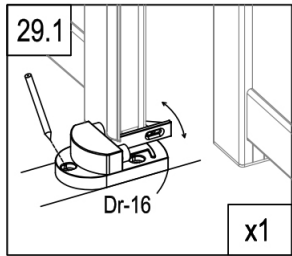
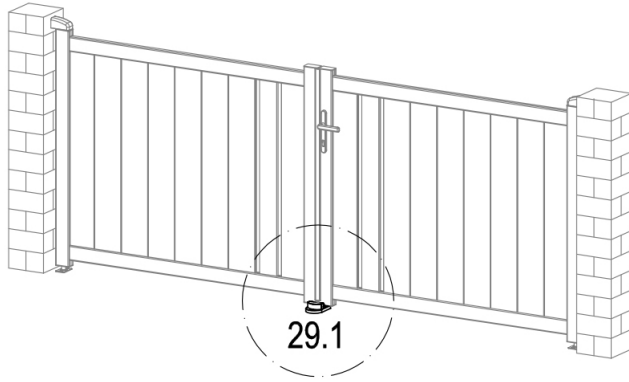

	Dr-15	2
	Dr-31	4



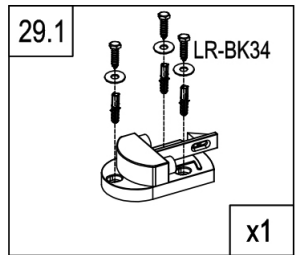

	Dr-16	1
	LR-BK34	3
	LR-BK35	3

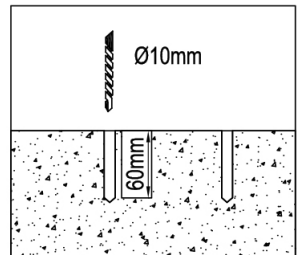
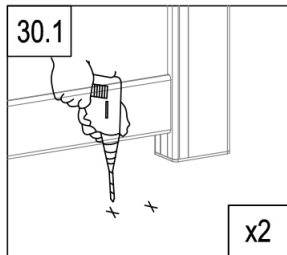
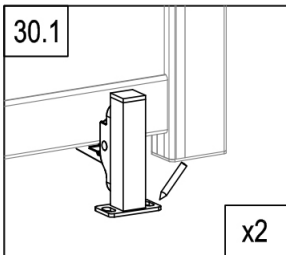
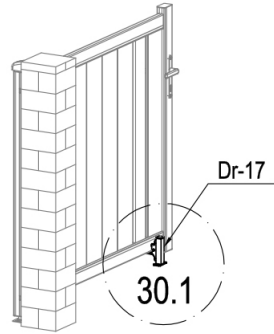
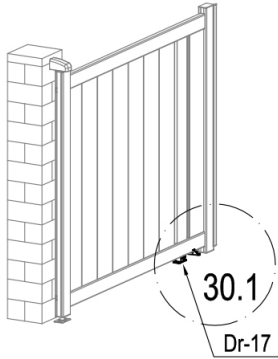

CASANOVO



	LR-BK32	4
	Dr-17	2

