

CASANOVO

GIONA 350B160

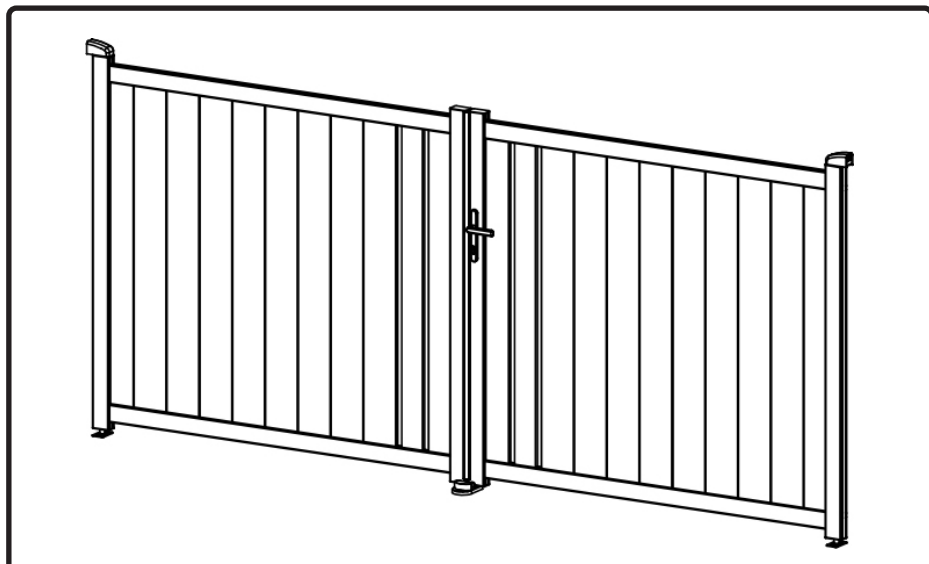

COM-000801 [x1]

COM-000803 [x1]

COM-000802 [x1]





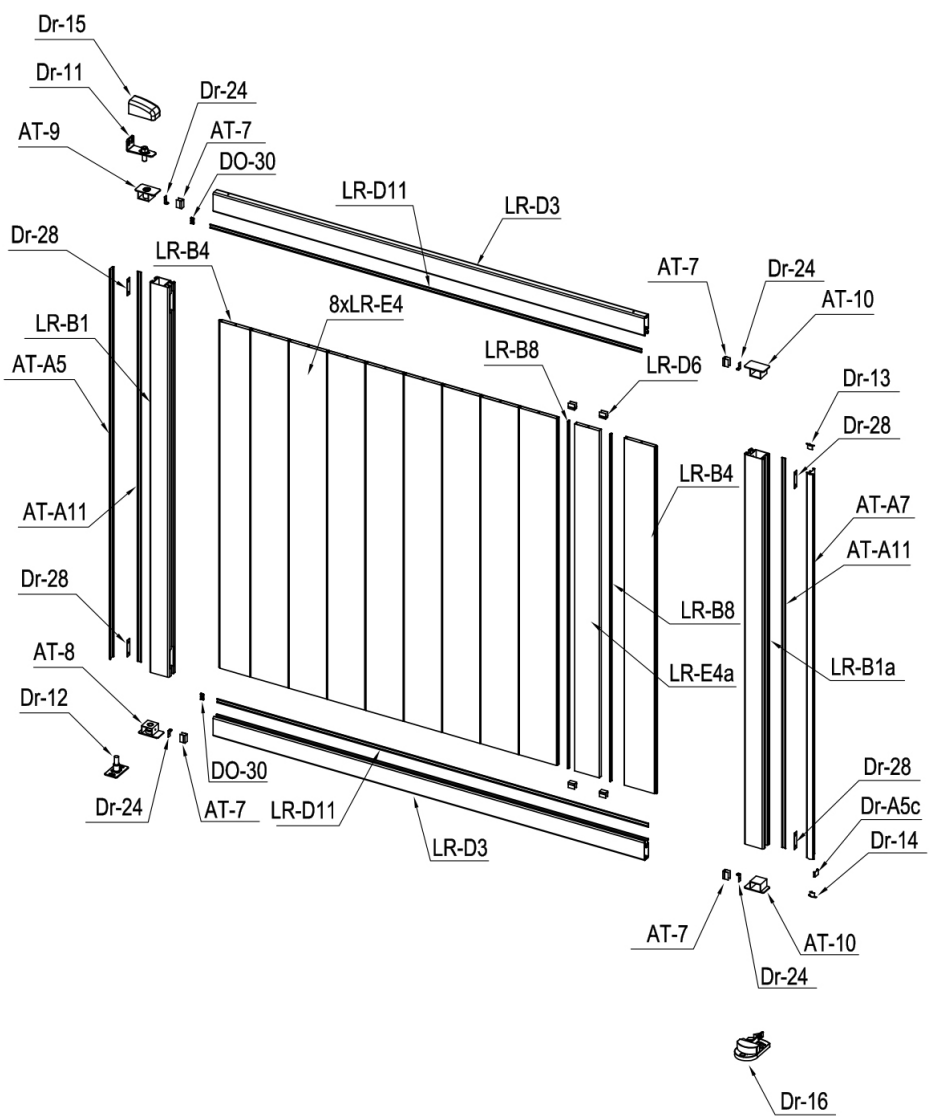

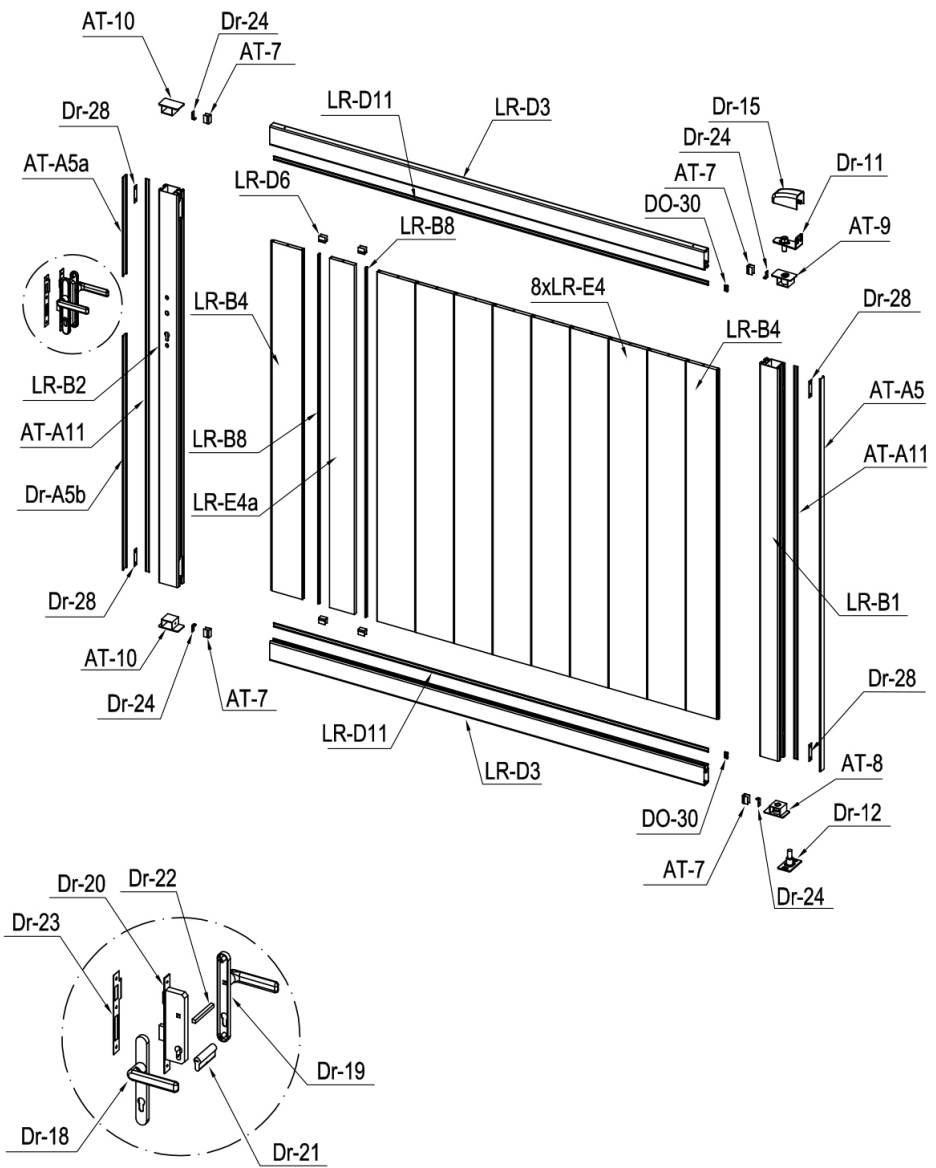



































INSTRUCTION MANUAL / NOTICE DE MONTAGE / MONTAGEANLEITUNG / MANUAL DE MONTAJE / MANUAL DE MONTAGEM / MANUALE DI MONTAGGIO /
MONTAGEHANDLEIDING / INSTRUKCJA MONTAŻU / KÄYTTÖOHJEET / BRUGSANVISNING / INSTRUCIUNI DE ASAMBLARE /
NAVODILA ZA SESTAVLJANJE / NÁVOD NA MONTÁŽ / ÖSSZESZERELÉSI ÚTMUTATÓ / NÁVOD K MONTÁŽI / UPUTE ZA INSTALACIJU /
ΟΔΗΓΙΕΣ ΣΥΝΑΡΜΟΛΟΓΗΣΗΣ / SURINKIMO INSTRUKCIJOS / MONTĀŽAS INSTRUKCIJAS









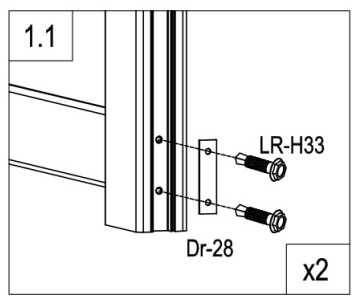
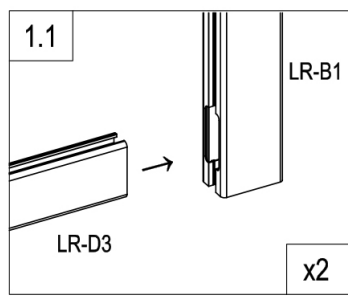
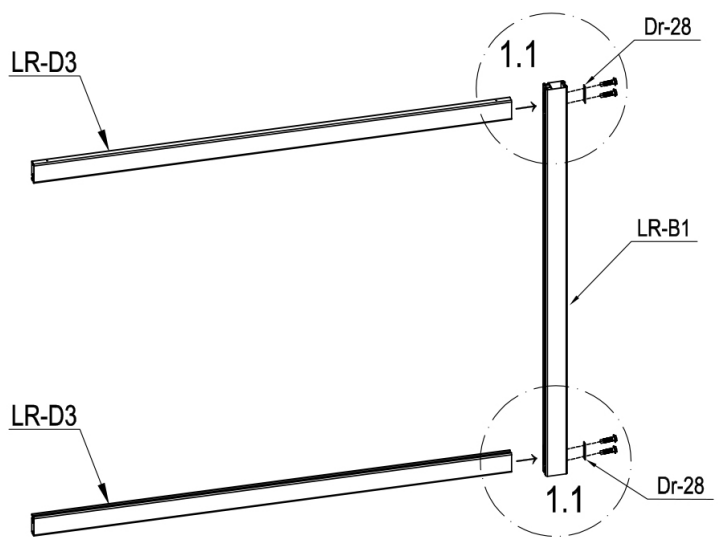



CASANOVO

IMAGE	NO.	L.(mm)	QTY	IMAGE	NO.	L.(mm)	QTY
	LR-B1	1573	2		Dr-16		1
	LR-B1a	1573	1		Dr-17		2
	LR-B2	1573	1		Dr-31		4
	LR-D3	1742	4		DO-30		4
	LR-E4	1400	16		Dr-18		1
	LR-B4	1400	4		Dr-19		1
	LR-E4a	1400	2		Dr-20		1
	AT-A5	1573	2		Dr-21		1
	AT-A5a	395.5	1		Dr-22		1
	Dr-A5b	937	1		Dr-23		1
	Dr-A5c	19.5	1		Dr-25		1
	AT-A11	1573	4		Dr-25a		2
	LR-D11	1742	4		Dr-26		3
	AT-7	29.5	8		Dr-27		2
	LR-D6	25	8		Dr-24		8
	LR-B8	1400	4		Dr-28		8
	AT-A7	1553	1		LR-H30		8
	AT-8		2		LR-H31		52
	AT-9		2		LR-H32		12
	AT-10		4		LR-H33		16
	Dr-11		2		LR-H34		3
	Dr-12		2		LR-H35		3
	Dr-13		1		LR-H36		8
	Dr-14		1				
	Dr-15		2				

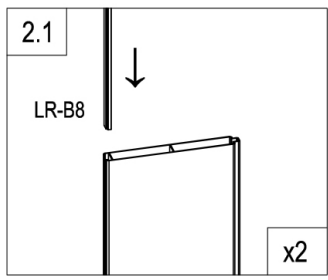
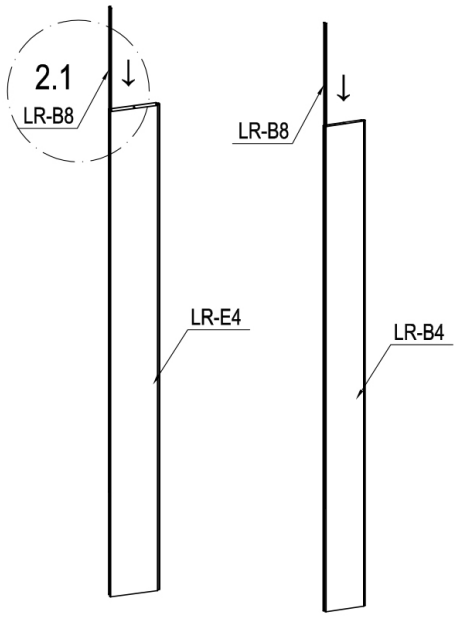



	LR-B1	1
	LR-D3	2
	Dr-28	2
	LR-H33	4



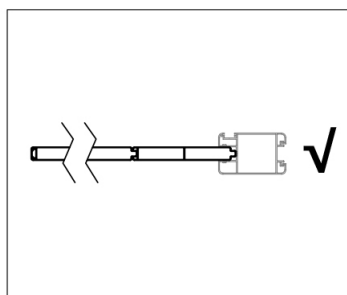
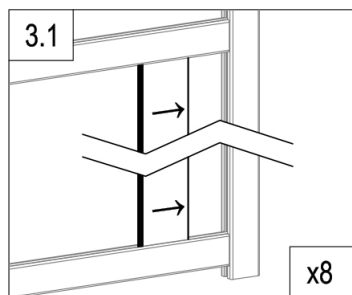
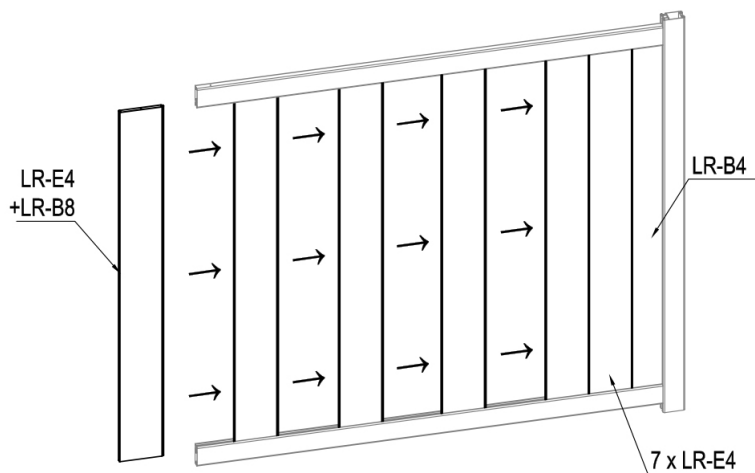

	LR-B8	2
	LR-E4	1
	LR-B4	1



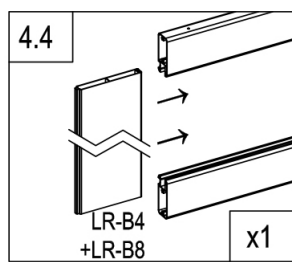
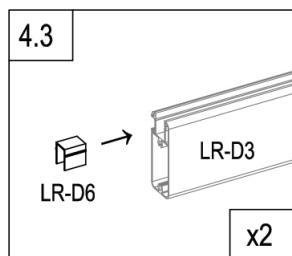
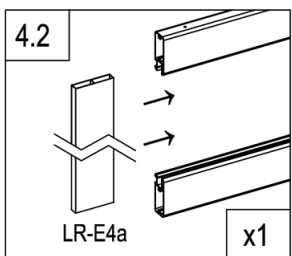
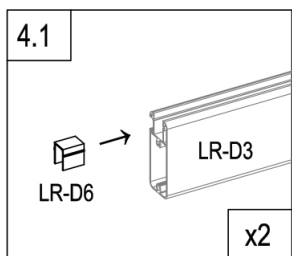
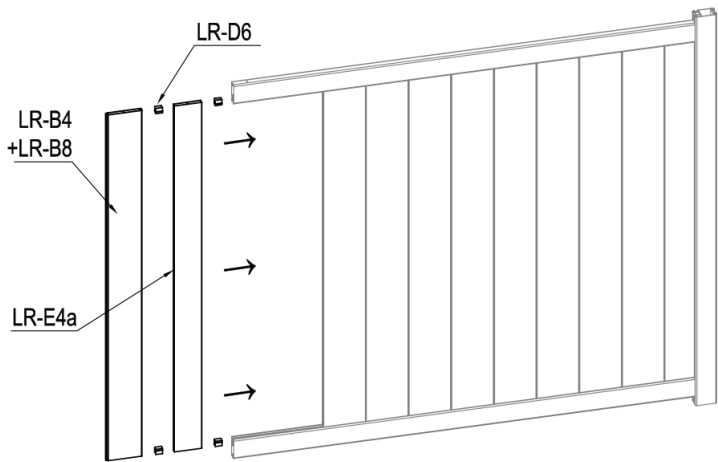

	LR-E4	7
	LR-B4	1

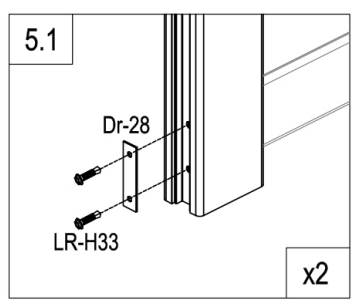
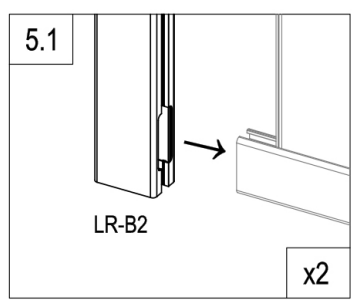
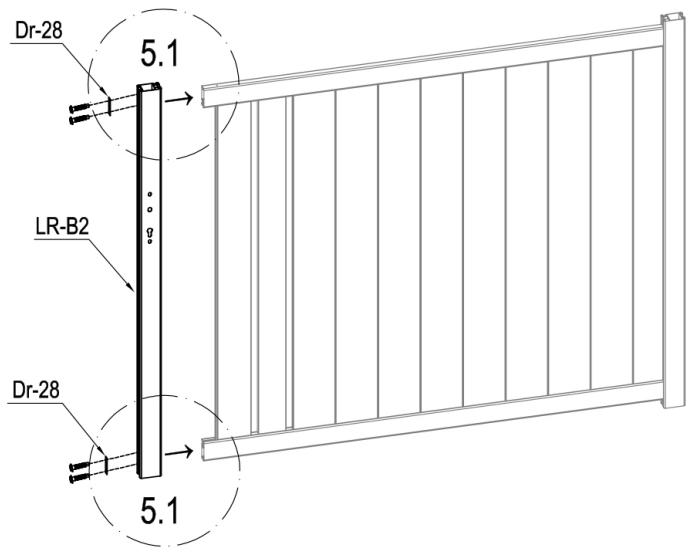

	LR-E4a	1
	LR-D6	4



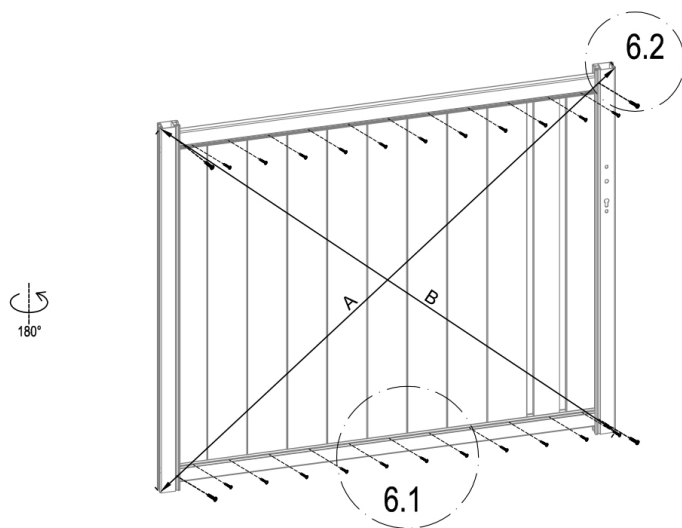

	LR-B2	1
	Dr-28	2
	LR-H33	4

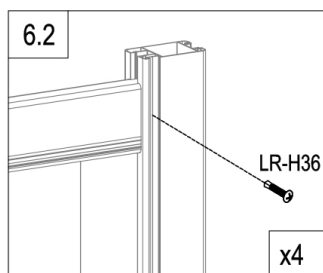
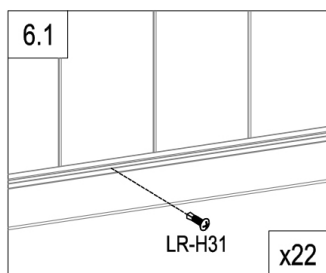

A=B



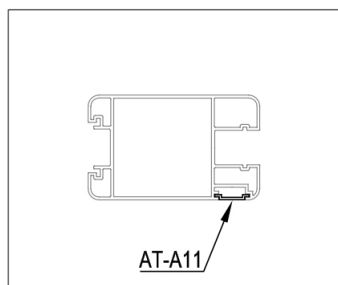
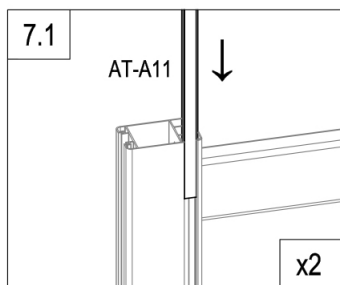
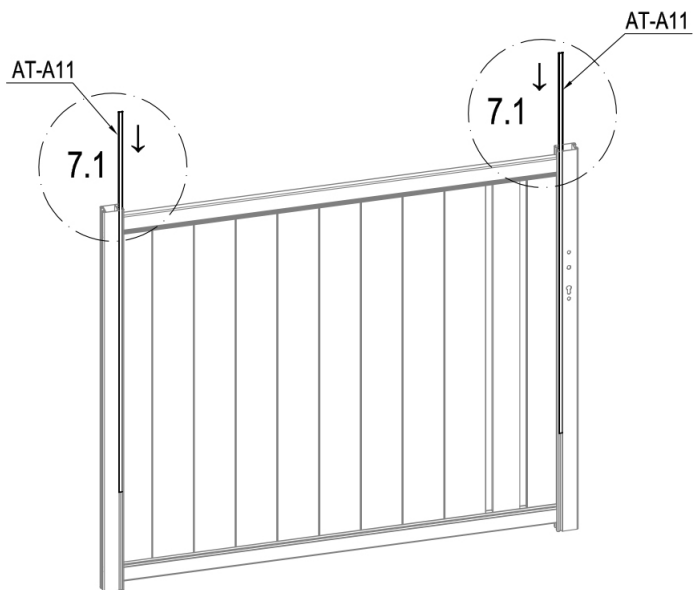

	LR-H31	22
	LR-H36	4

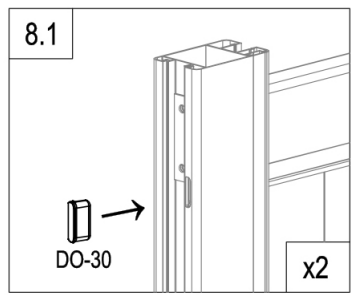
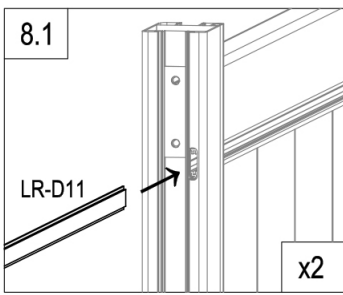
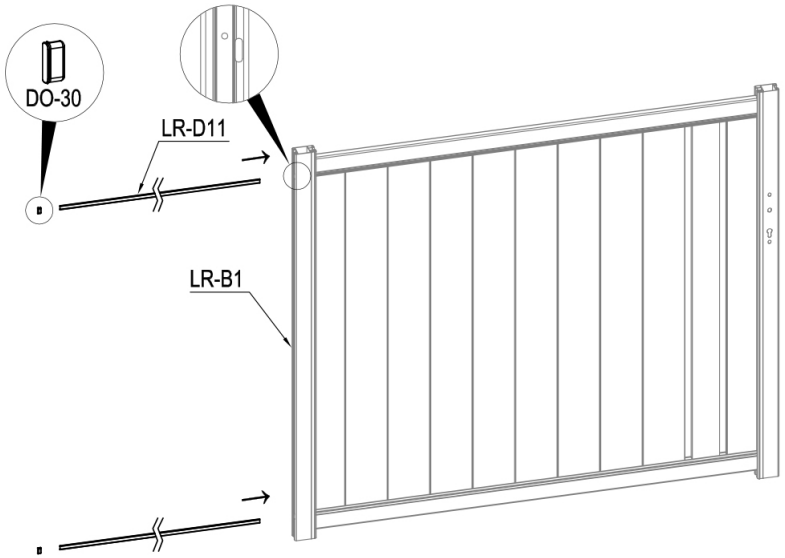

	AT-A11	2
---	--------	---



	LR-D11	2
	DO-30	2

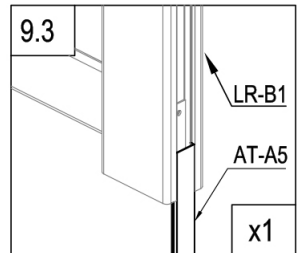
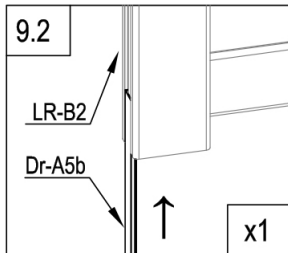
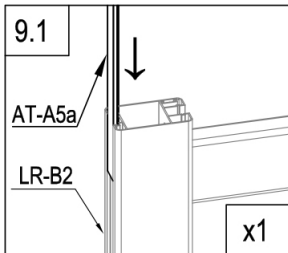
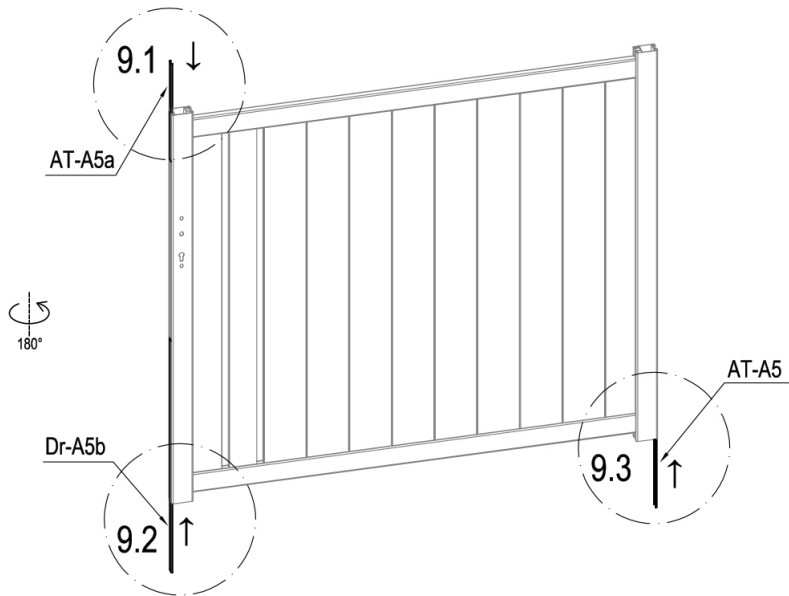

	AT-A5	1
	AT-A5a	1
	Dr-A5b	1

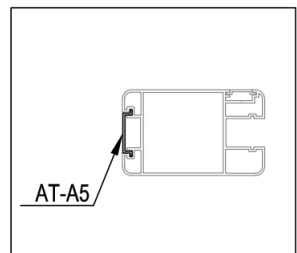

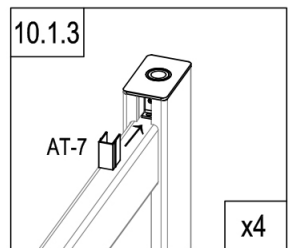
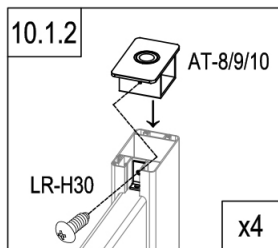
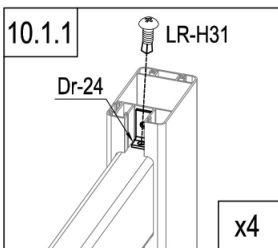
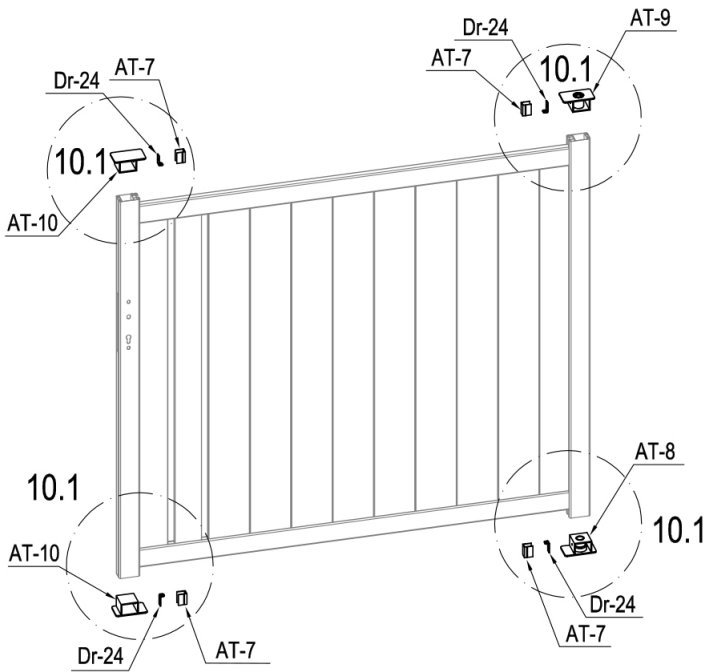

	AT-8	1
	AT-9	1
	AT-10	2
	Dr-24	4



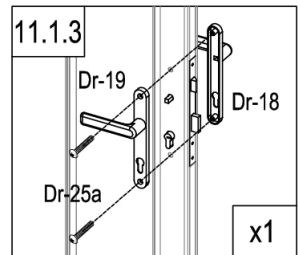
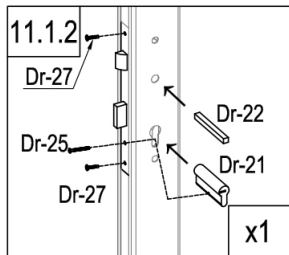
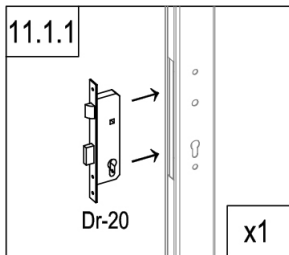
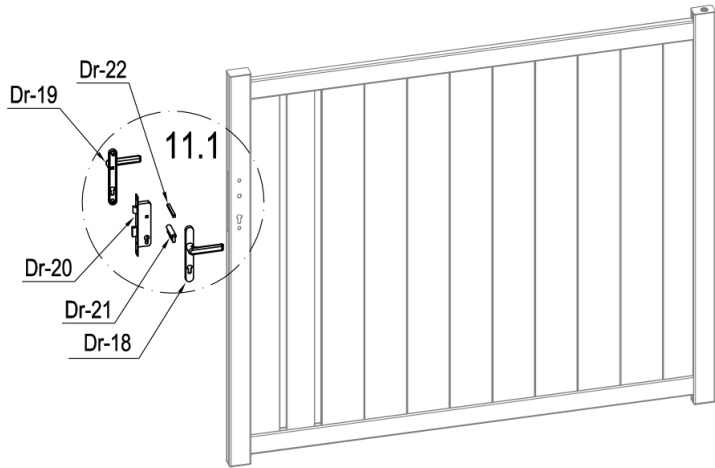

	AT-7	4
	LR-H30	4
	LR-H31	4



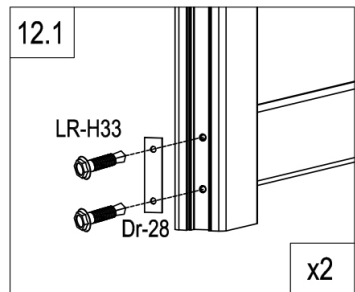
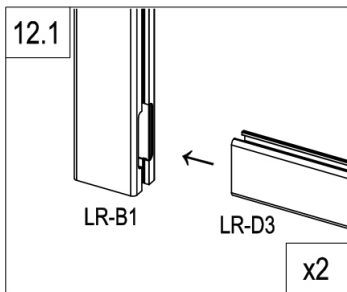
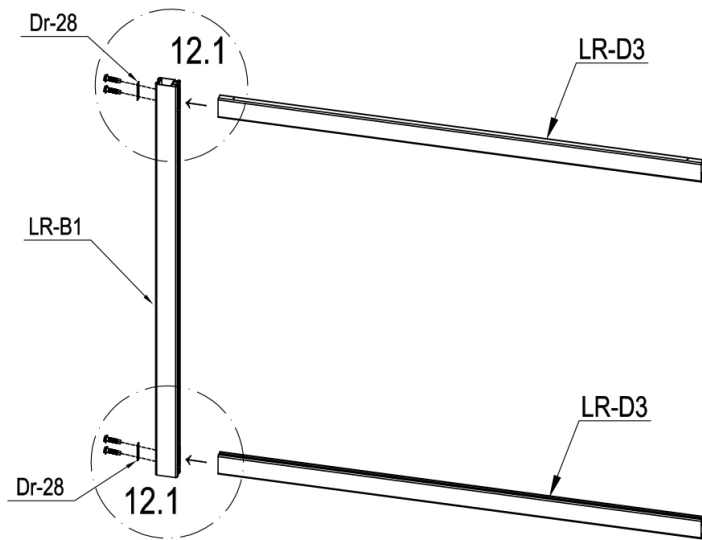



	Dr-20	1
	Dr-21	1
	Dr-22	1
	Dr-25	1

	Dr-18	1
	Dr-19	1
	Dr-25a	2
	Dr-27	2

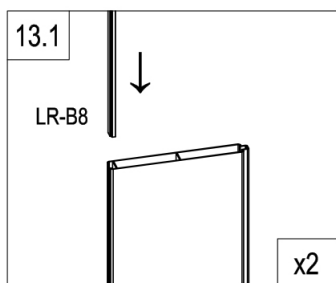
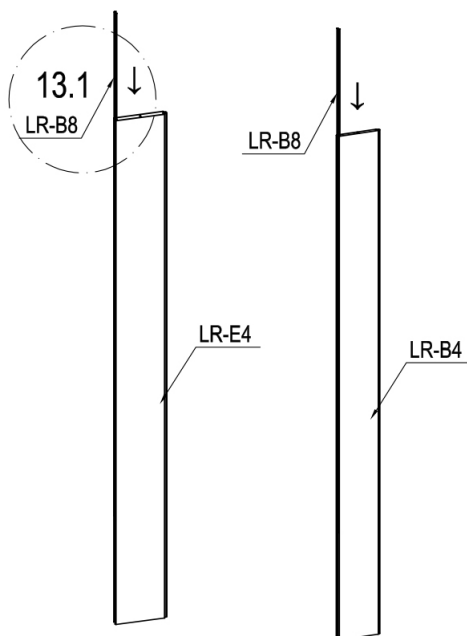



	LR-B1	1
	LR-D3	2
	Dr-28	2
	LR-H33	4



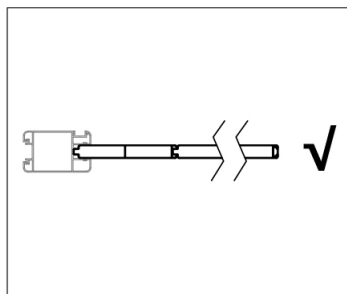
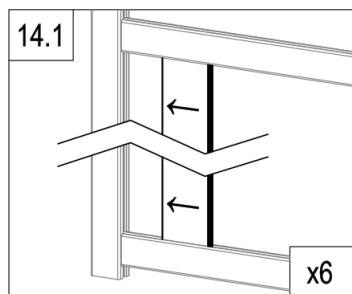
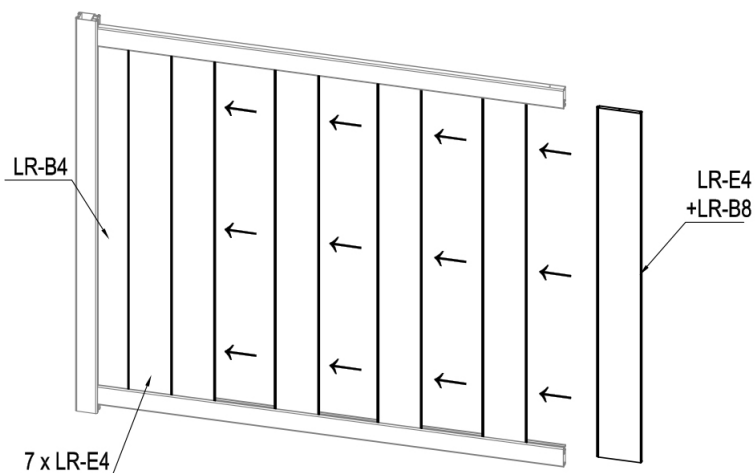

	LR-B8	2
	LR-E4	1
	LR-B4	1



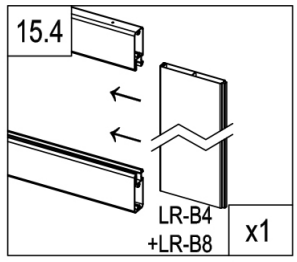
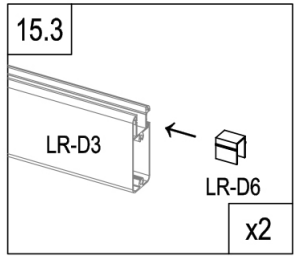
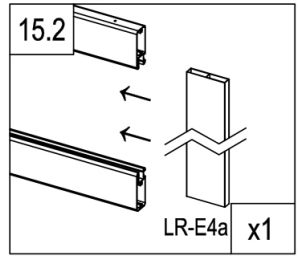
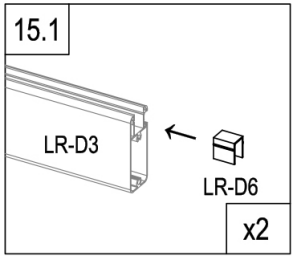
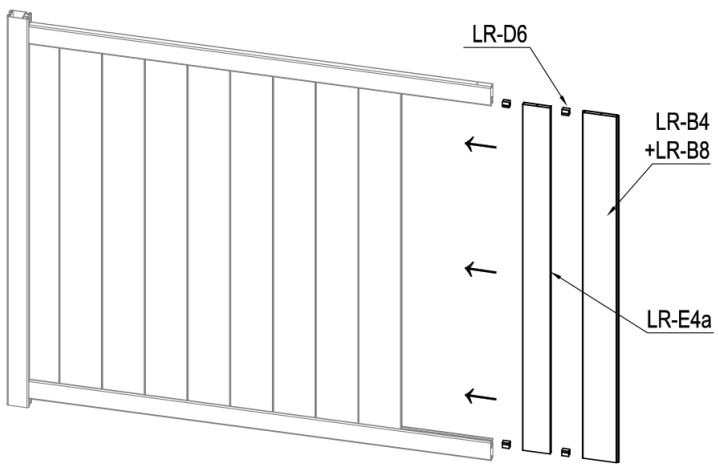

	LR-E4	7
	LR-B4	1

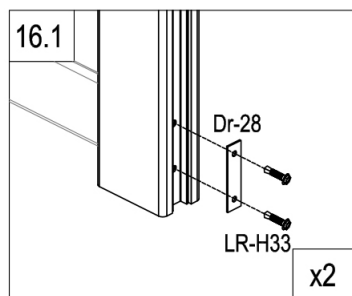
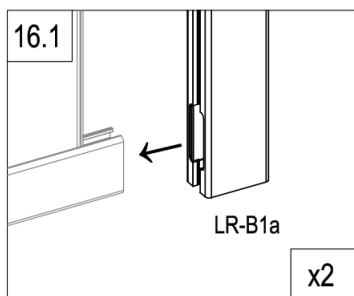
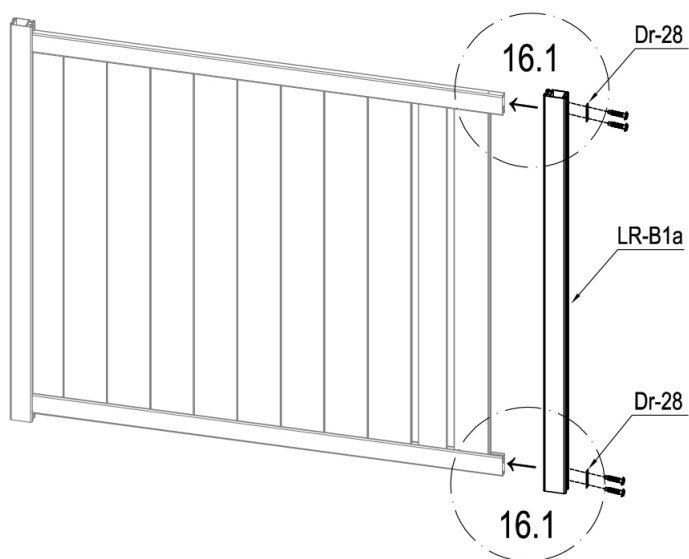

	LR-E4a	1
	LR-D6	4



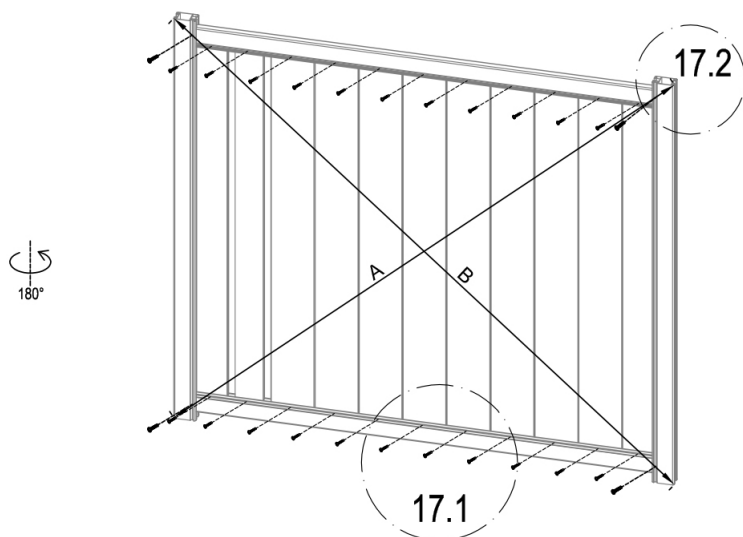

	LR-B1a	1
	Dr-28	2
	LR-H33	4

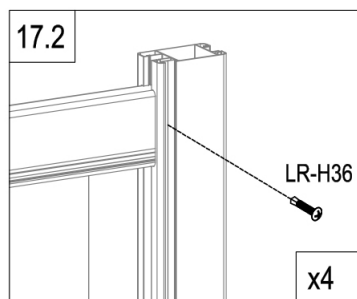
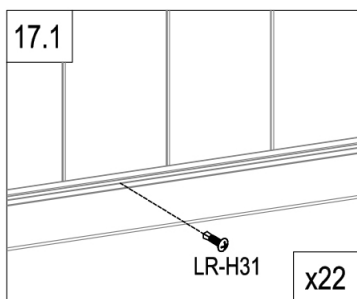

A=B



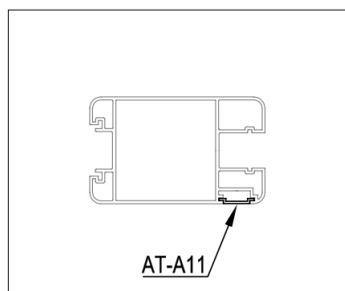
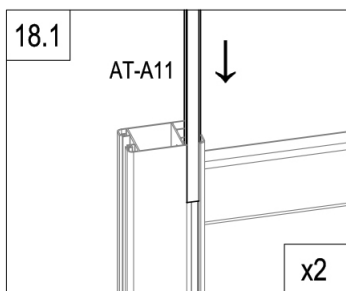
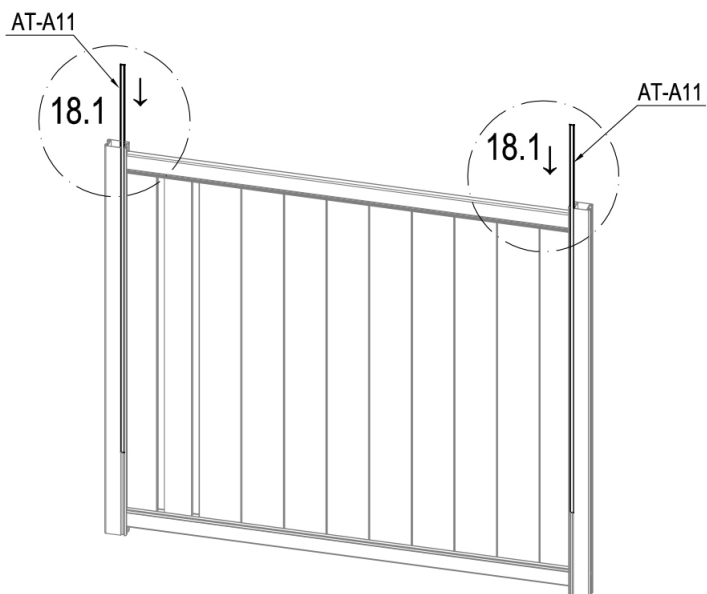

	LR-H31	22
	LR-H36	4

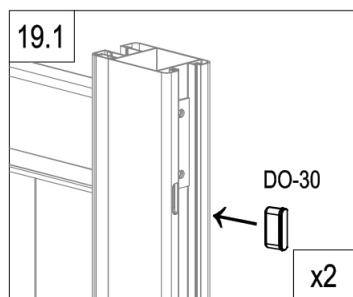
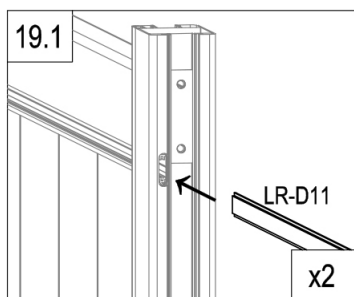
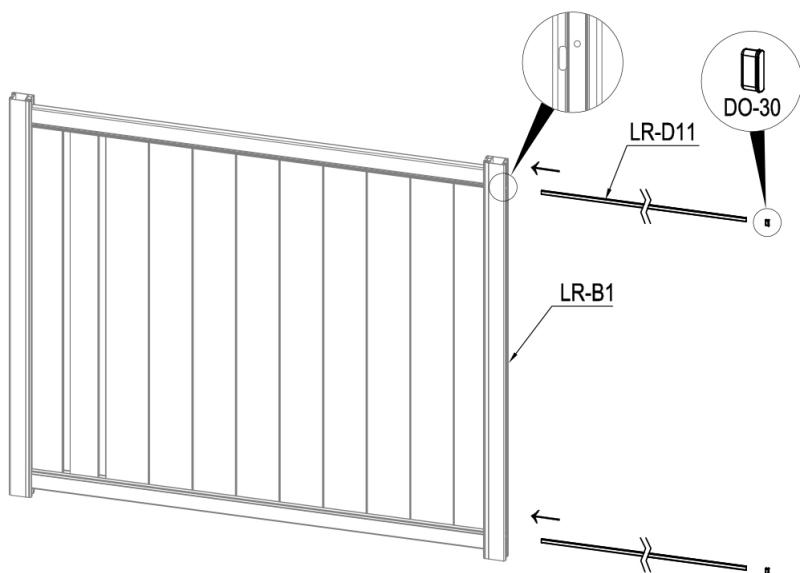

	AT-A11	2
---	--------	---





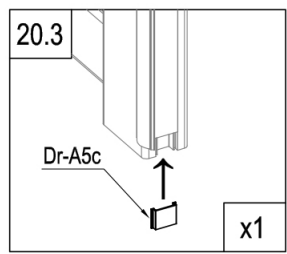
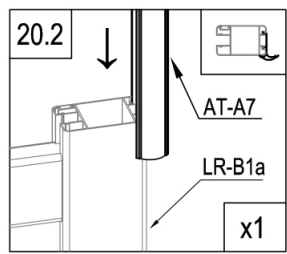
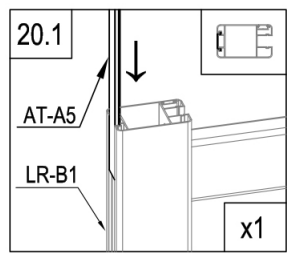
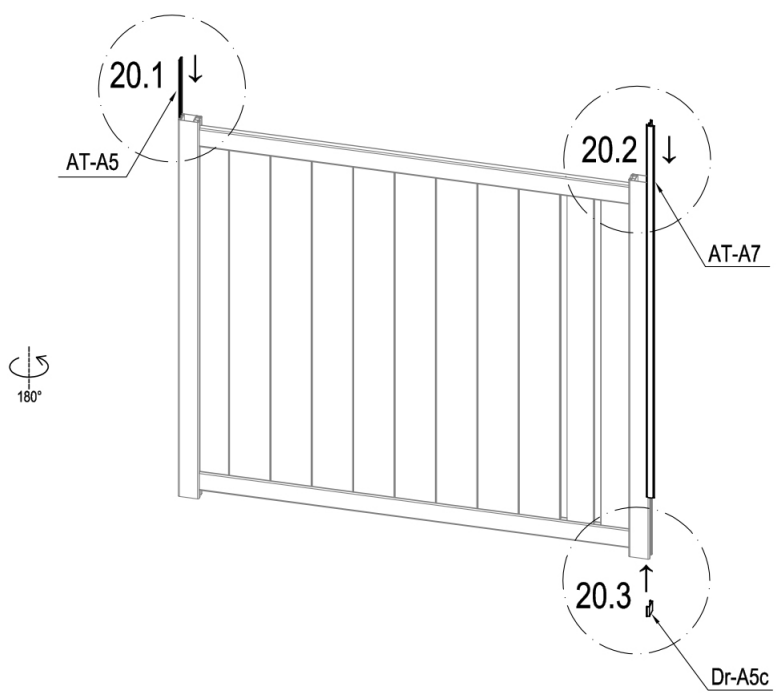

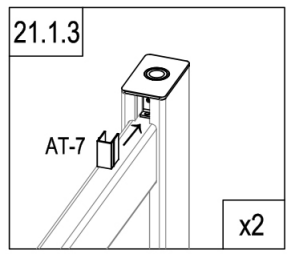
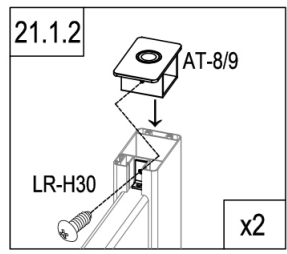
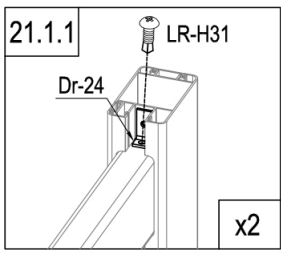
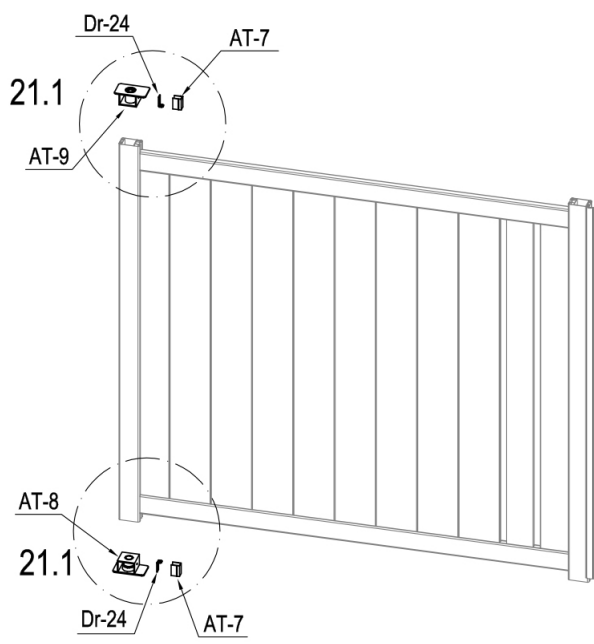

	LR-D11	2
	DO-30	2



	AT-A5	1
	Dr-A5c	1
	AT-A7	1



	AT-8	1
	AT-9	1
	Dr-24	2

	AT-7	2
	LR-H30	2
	LR-H31	2

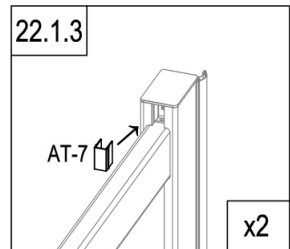
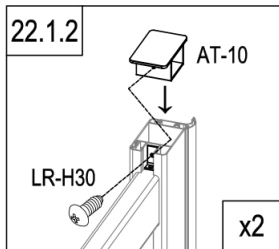
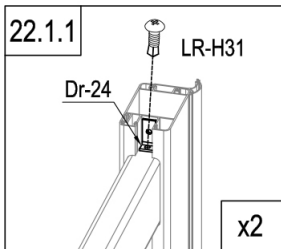
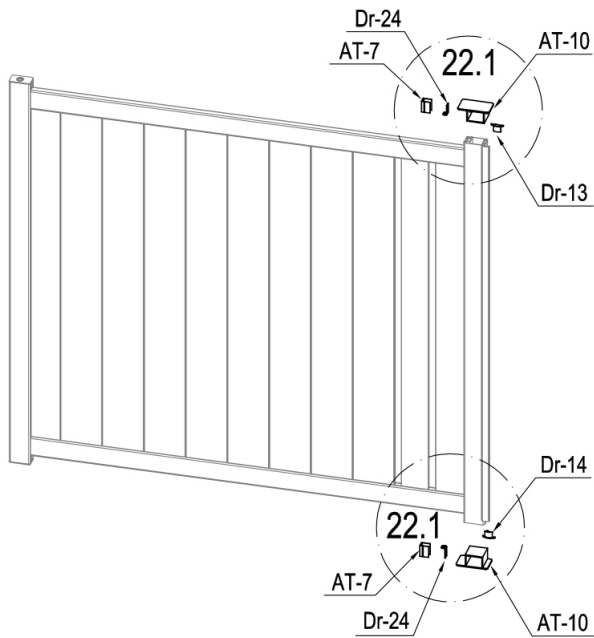

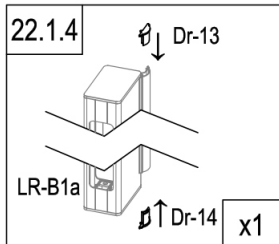

	AT-10	2
	Dr-24	2
	AT-7	2
	Dr-13	1

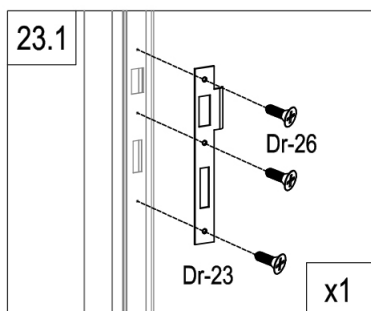
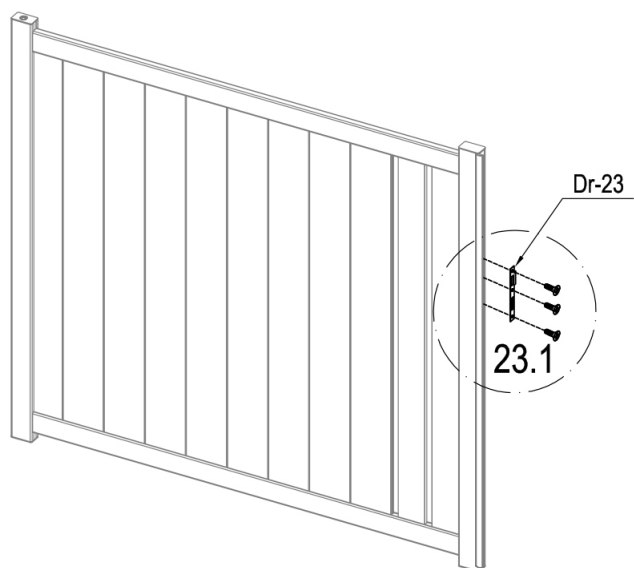

	Dr-14	1
	LR-H30	2
	LR-H31	2



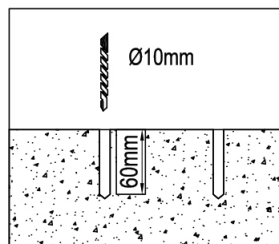
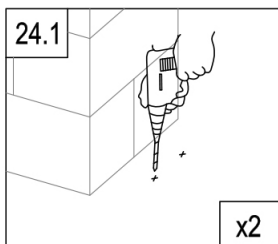
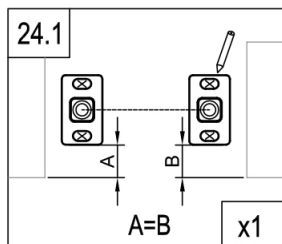
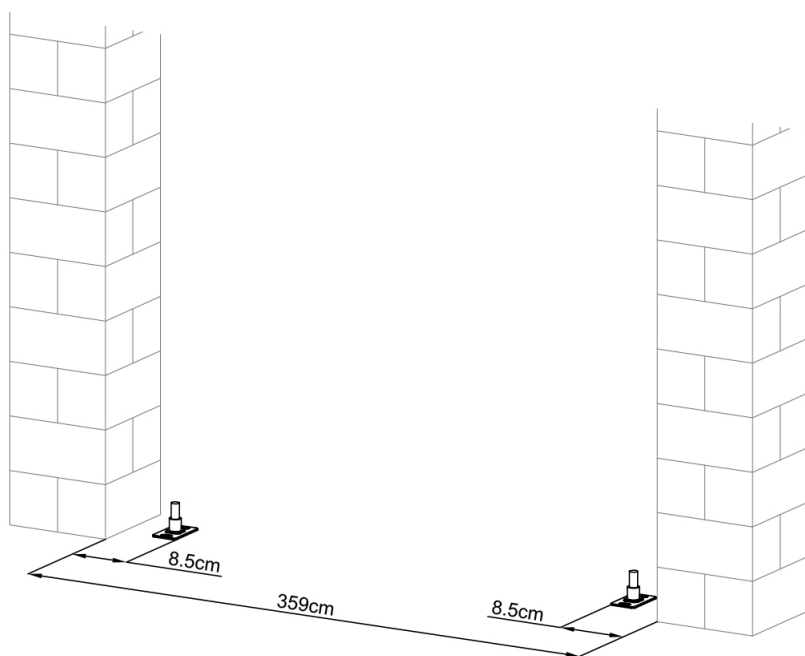

	Dr-23	1
	Dr-26	3



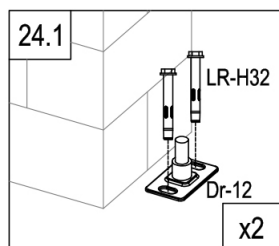

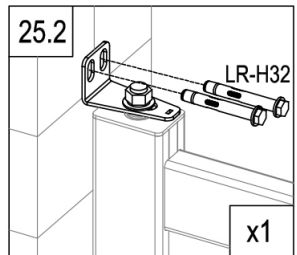
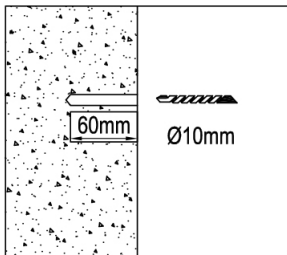
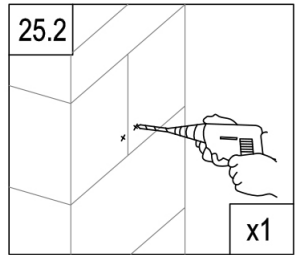
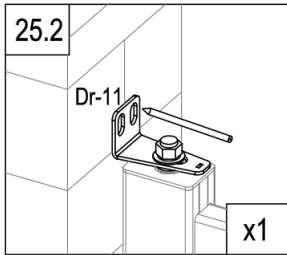
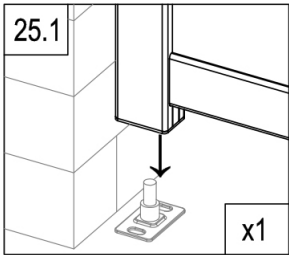
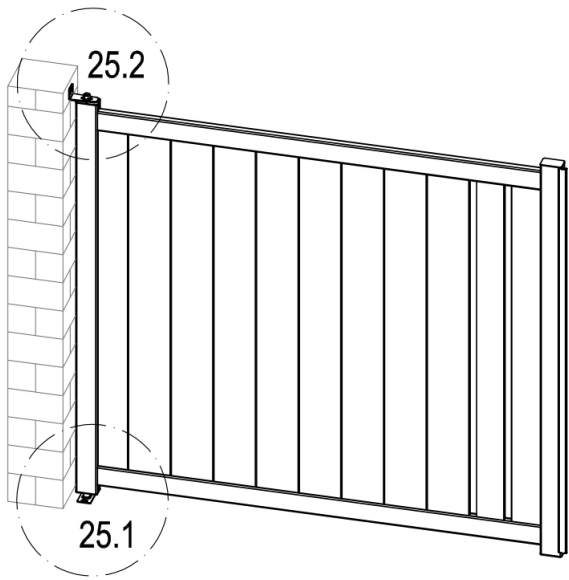
	Dr-12	2
	LR-H32	4





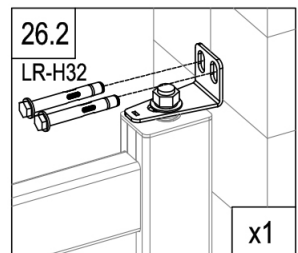
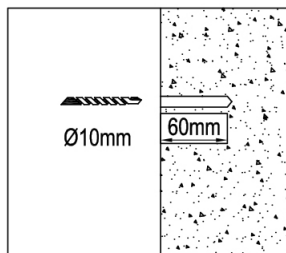
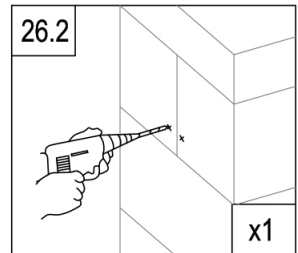
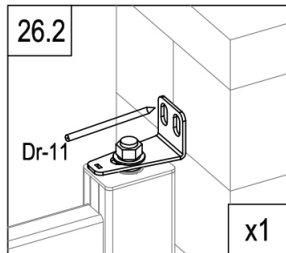
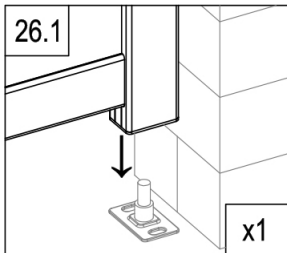
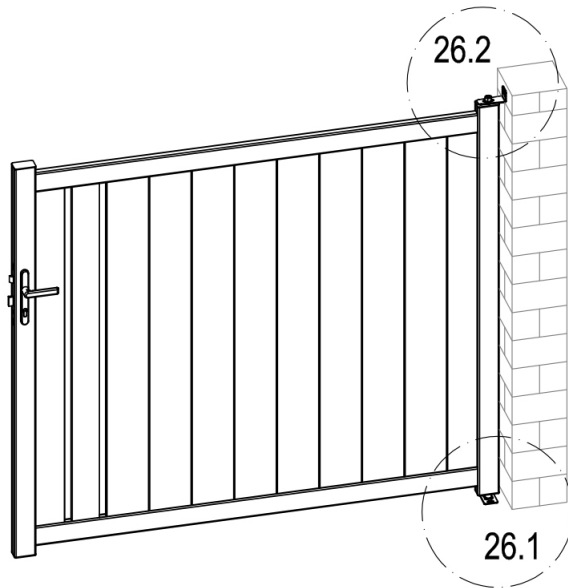

	Dr-11	1
	LR-H32	2



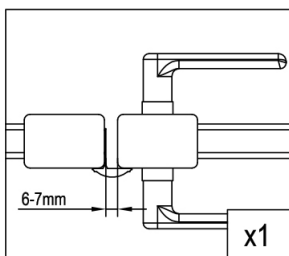
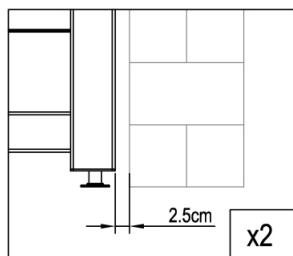
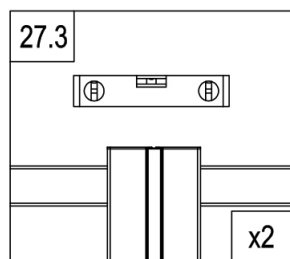
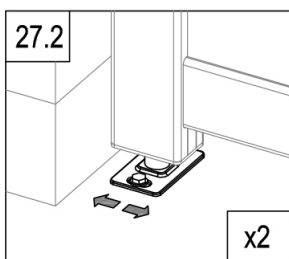
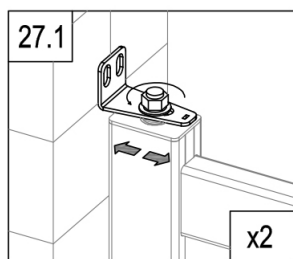
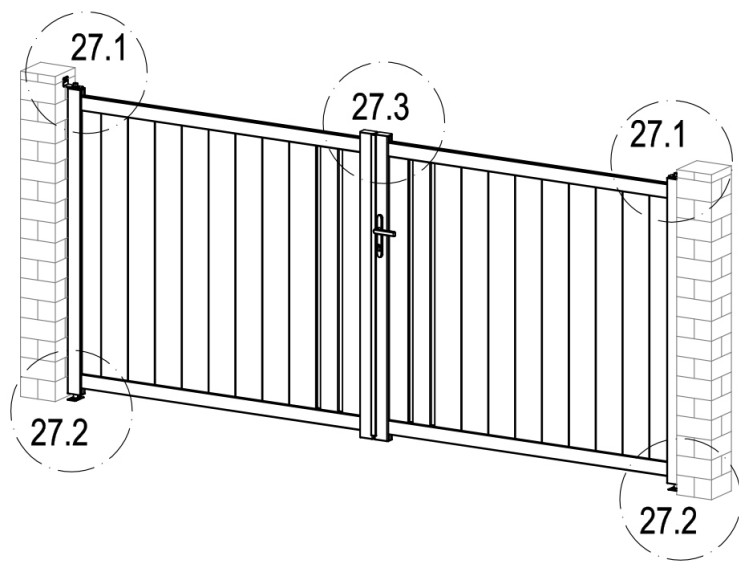

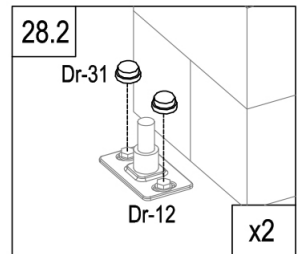
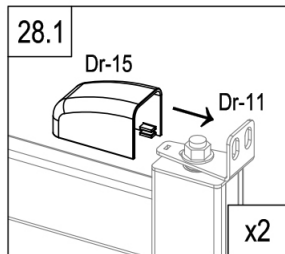
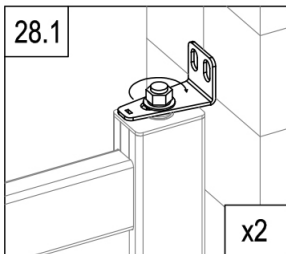
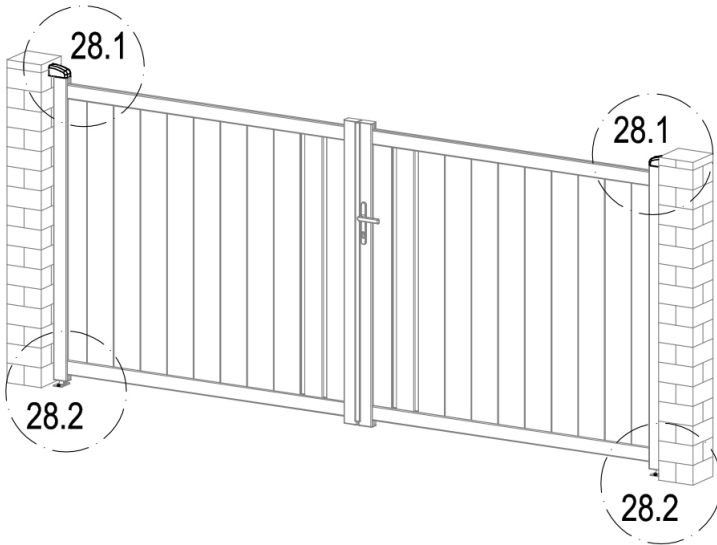

	Dr-11	1
	LR-H32	2



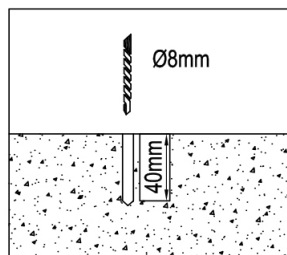
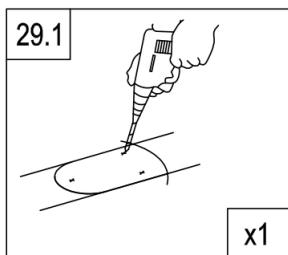
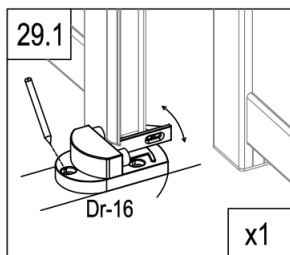
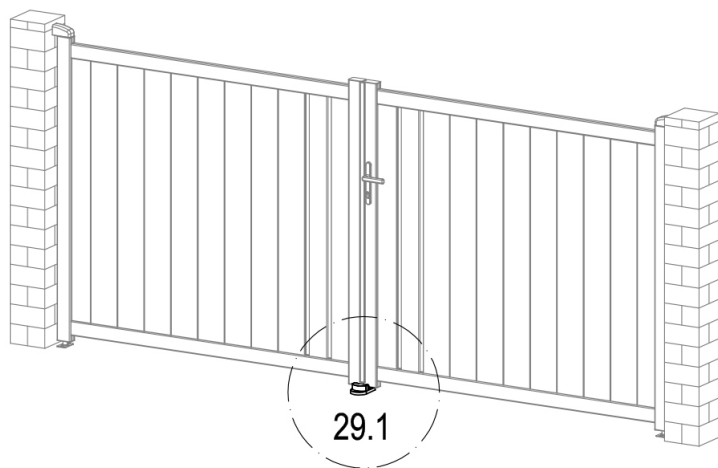

	Dr-15	2
	Dr-31	4



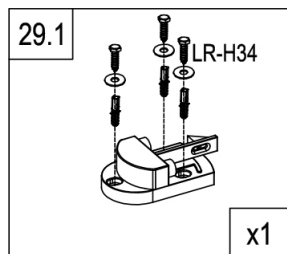

	Dr-16	1
	LR-H34	3
	LR-H35	3

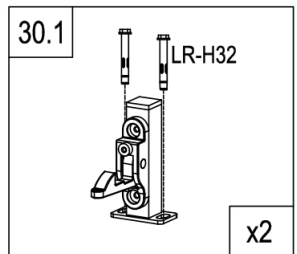
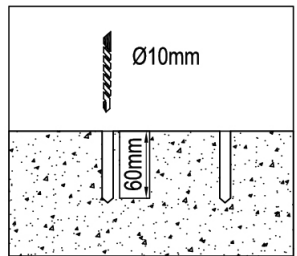
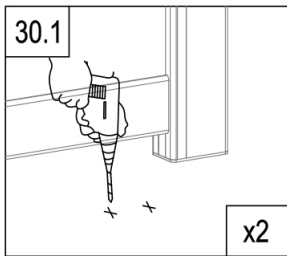
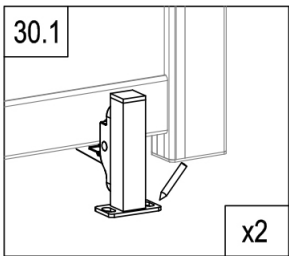
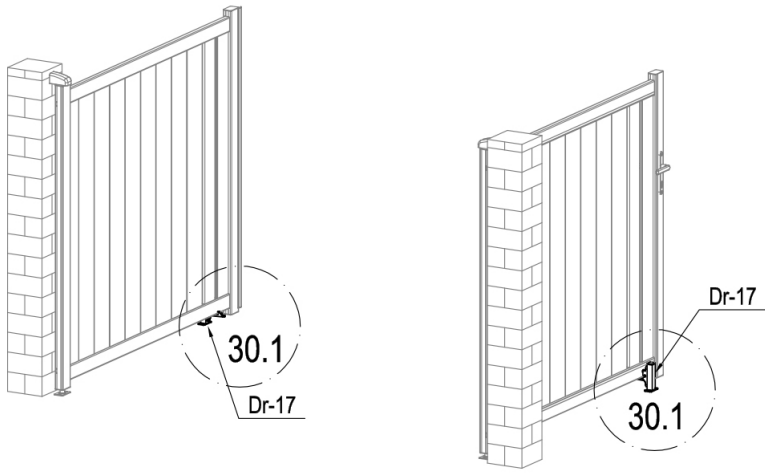

CASANOVO



	LR-H32	4
	Dr-17	2

