

# CASANOVO

## GIONA 350B140

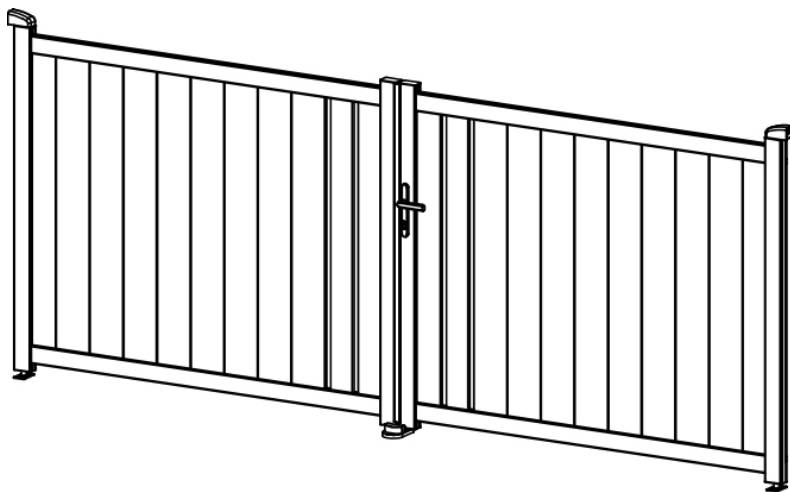

COM-000798 [x1]

COM-000800 [x1]

COM-000799 [x1]



5-7H



X 2





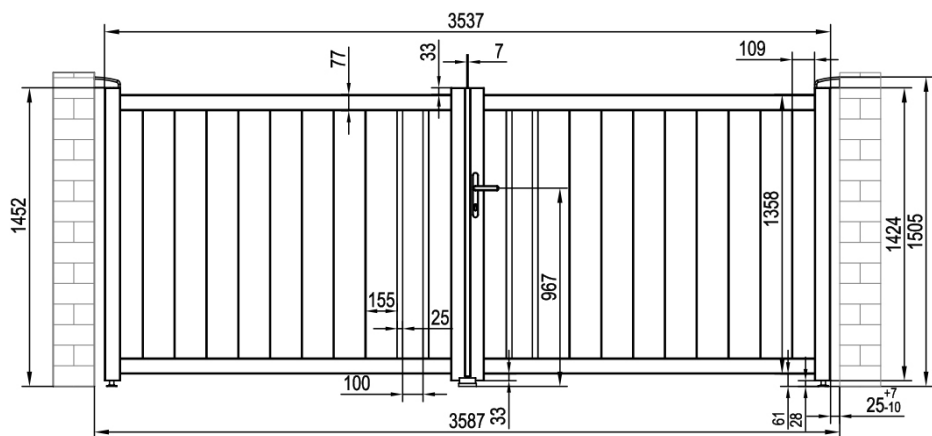

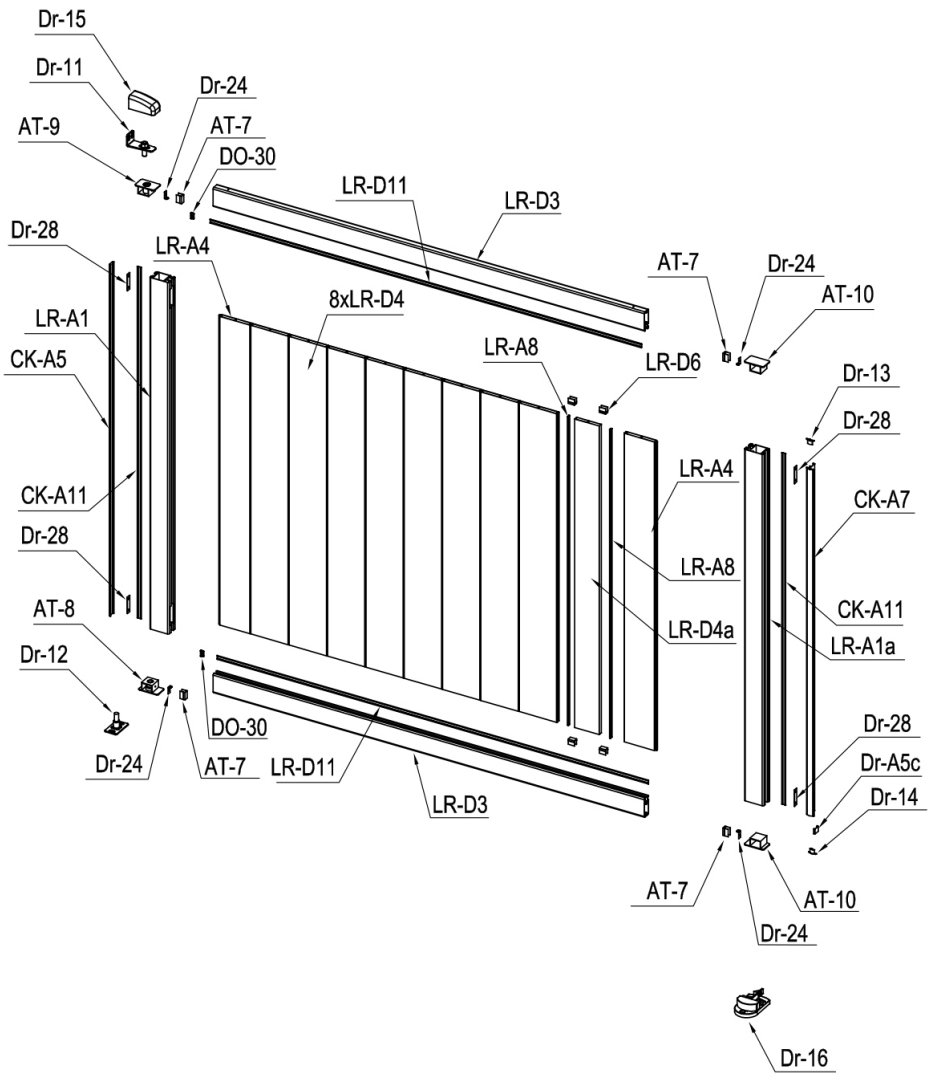



































INSTRUCTION MANUAL / NOTICE DE MONTAGE / MONTAGEANLEITUNG / MANUAL DE MONTAJE / MANUAL DE MONTAGEM / MANUALE DI MONTAGGIO /  
MONTAGEHANDLEIDING / INSTRUKCJA MONTAŻU / KÄYTTÖOHJEET / BRUGSANVISNING / BRUGSANVISNING / INSTRUCIUNI DE ASAMBLARE /  
NAVODILA ZA SESTAVLJANJE / NÁVOD NA MONTÁŽ / ÖSSZESZERELÉSI ÚTMUTATÓ / NÁVOD K MONTÁŽI / UPUTE ZA INSTALACIJU /  
ΟΔΗΓΙΕΣ ΣΥΝΑΡΜΟΛΟΓΗΣΗΣ / SURINKIMO INSTRUKCIJOS / MONTĀŽAS INSTRUKCIJAS











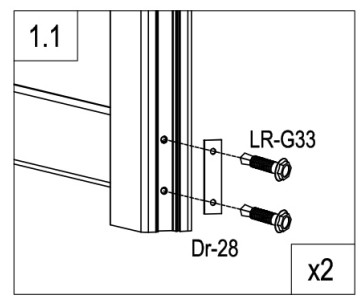
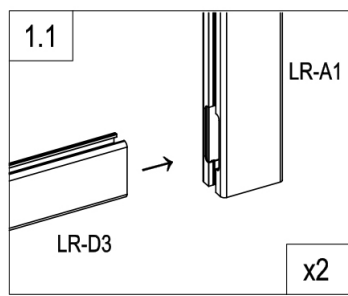
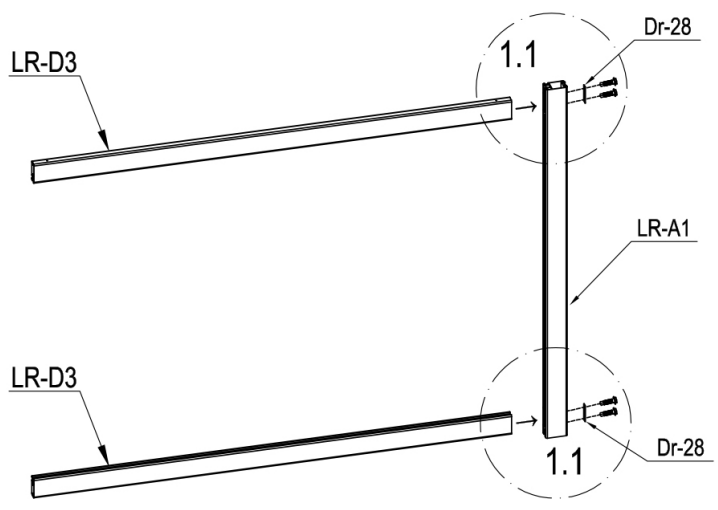



# CASANOVO

IMAGE	NO.	L.(mm)	QTY	IMAGE	NO.	L.(mm)	QTY
	LR-A1	1418	2		Dr-16		1
	LR-A1a	1418	1		Dr-17		2
	LR-A2	1418	1		Dr-31		4
	LR-D3	1742	4		DO-30		4
	LR-D4	1245	16		Dr-18		1
	LR-A4	1245	4		Dr-19		1
	LR-D4a	1245	2		Dr-20		1
	CK-A5	1418	2		Dr-21		1
	AT-A5a	395.5	1		Dr-22		1
	SR-A5a	782	1		Dr-23		1
	Dr-A5c	19.5	1		Dr-25		1
	CK-A11	1418	4		Dr-25a		2
	LR-D11	1742	4		Dr-26		3
	AT-7	29.5	8		Dr-27		2
	LR-D6	25	8		Dr-24		8
	LR-A8	1245	4		Dr-28		8
	CK-A7	1398	1		LR-G30		8
	AT-8		2		LR-G31		52
	AT-9		2		LR-G32		12
	AT-10		4		LR-G33		16
	Dr-11		2		LR-G34		3
	Dr-12		2		LR-G35		3
	Dr-13		1		LR-G36		8
	Dr-14		1				
	Dr-15		2				

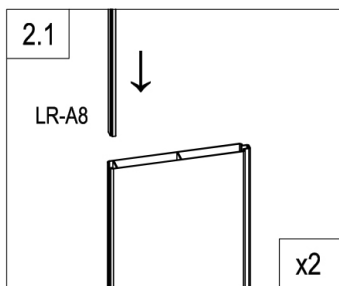
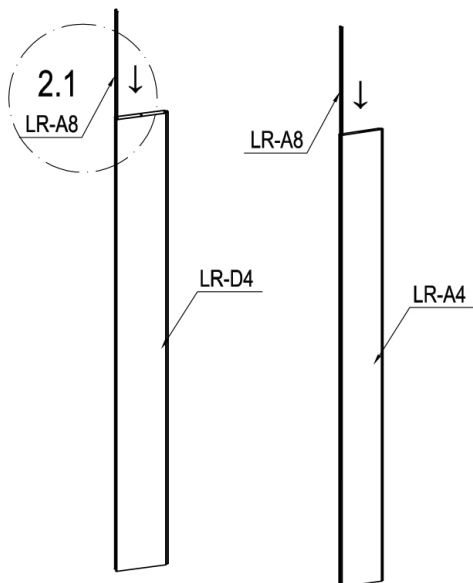



	LR-A1	1
	LR-D3	2
	Dr-28	2
	LR-G33	4



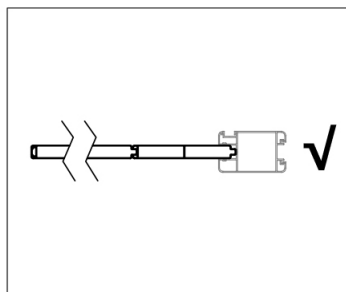
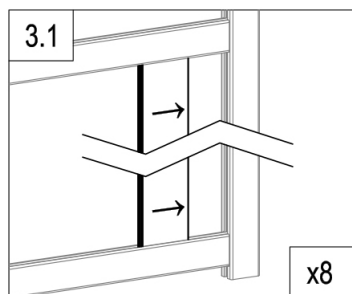
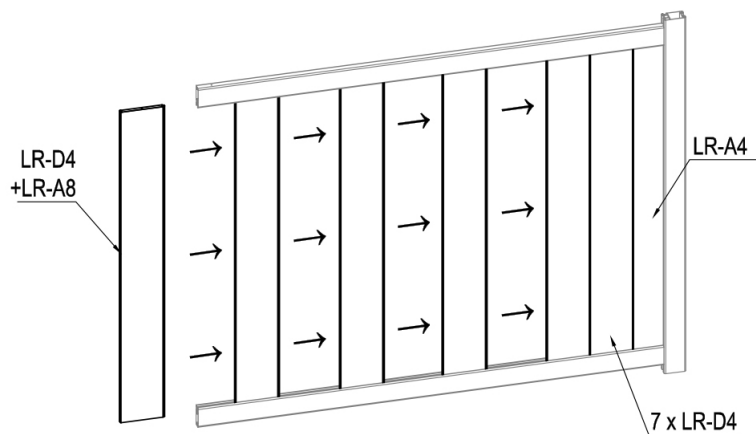

	LR-A8	2
	LR-D4	1
	LR-A4	1





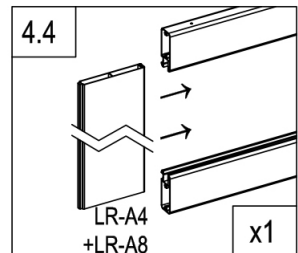
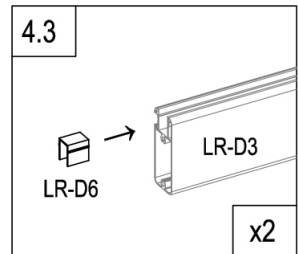
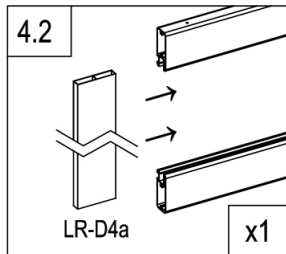
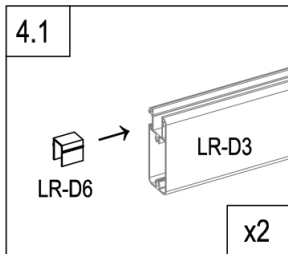
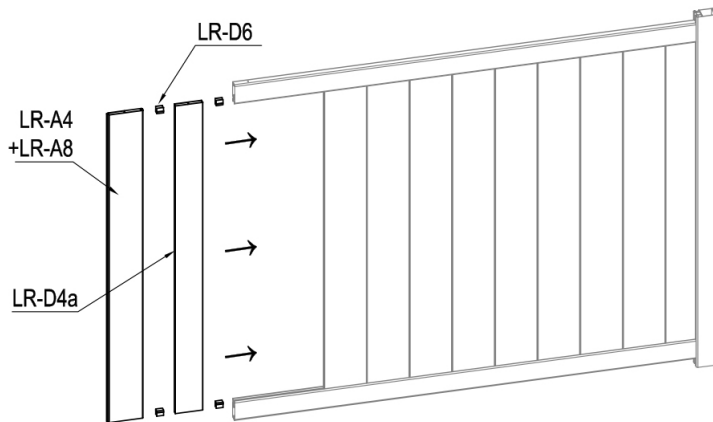

	LR-D4	7
	LR-A4	1



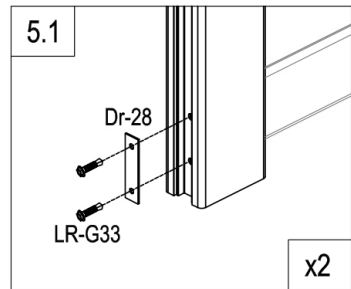
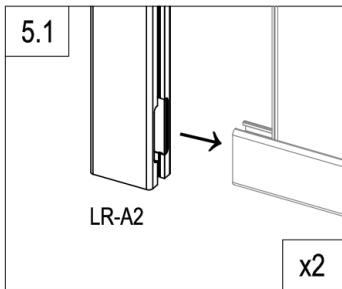
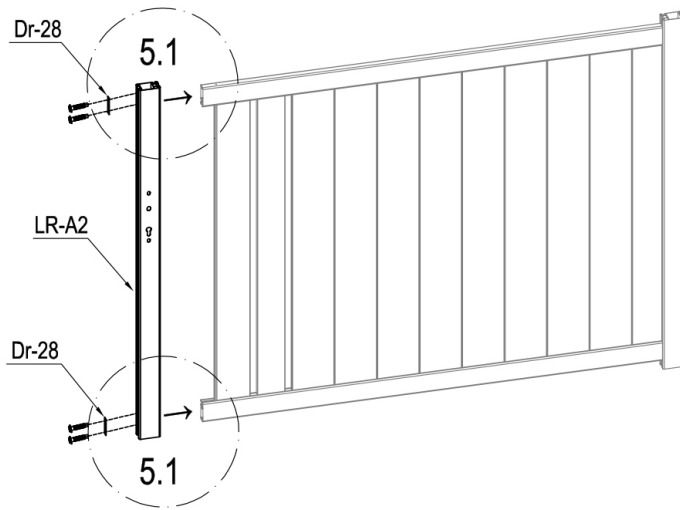



	LR-D4a	1
	LR-D6	4

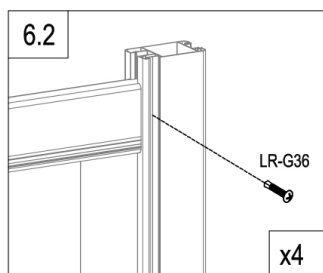
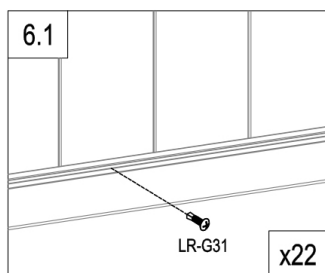
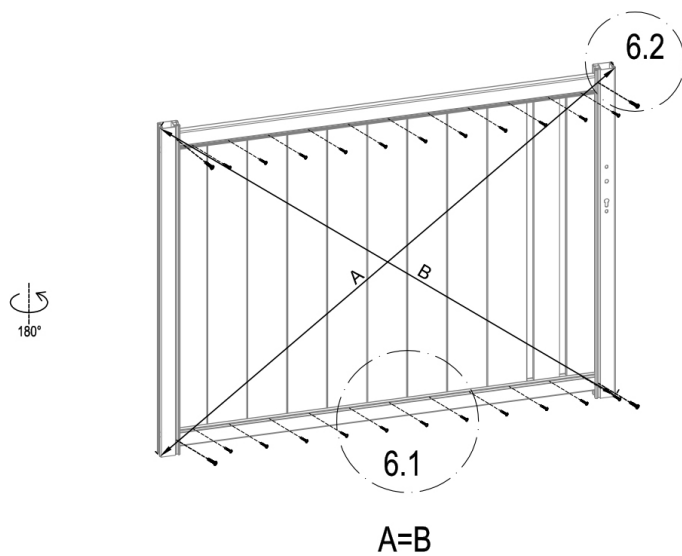

	LR-A2	1
	Dr-28	2
	LR-G33	4



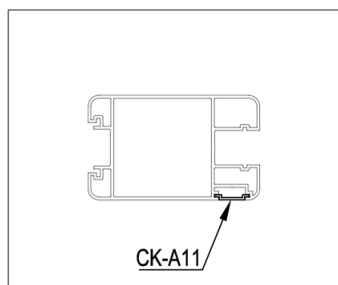
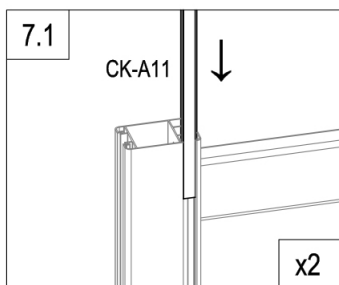
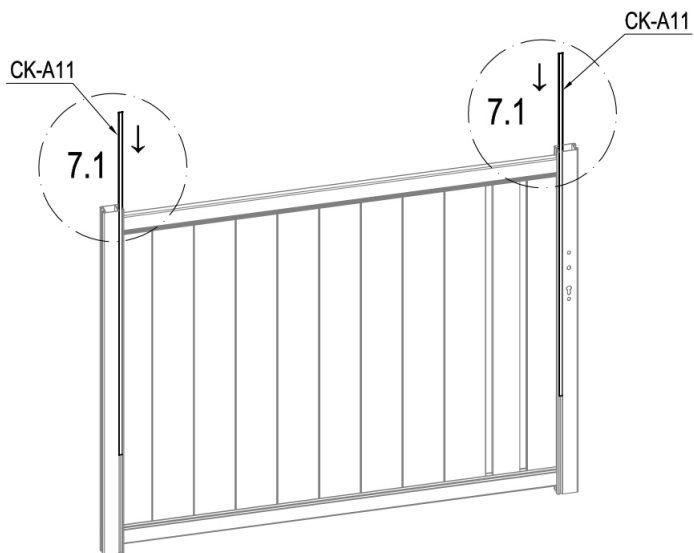

	LR-G31	22
	LR-G36	4

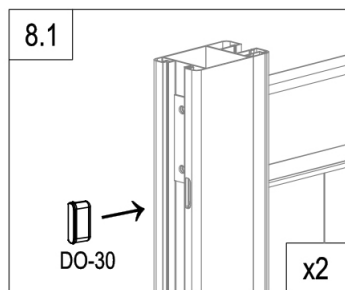
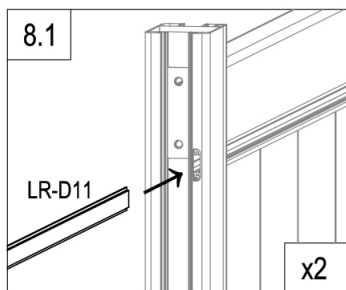
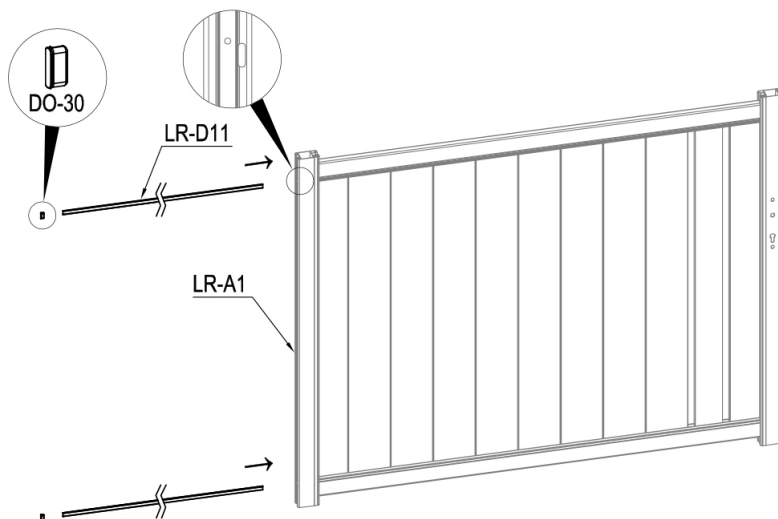

	CK-A11	2
---	--------	---



	LR-D11	2
	DO-30	2

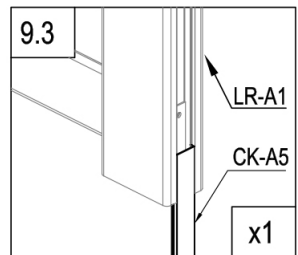
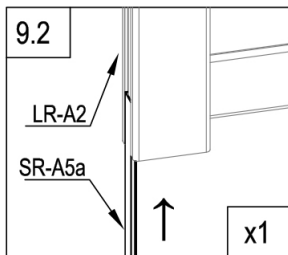
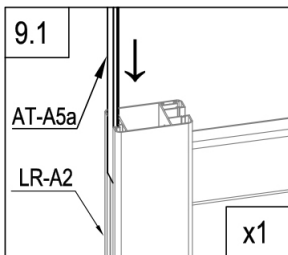
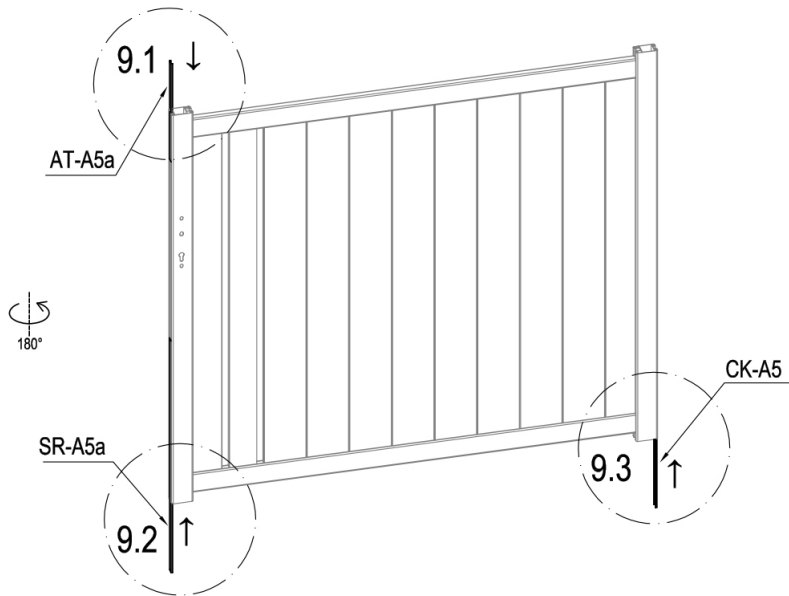

	CK-A5	1
	AT-A5a	1
	SR-A5a	1

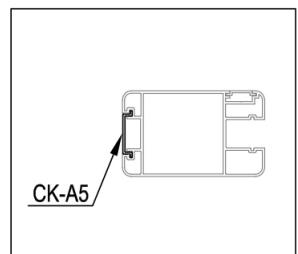

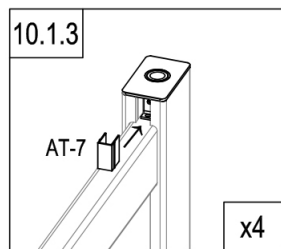
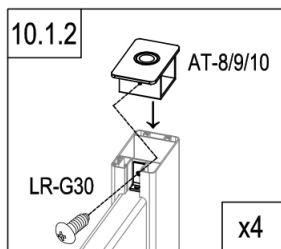
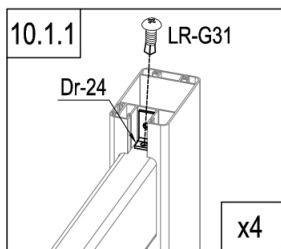
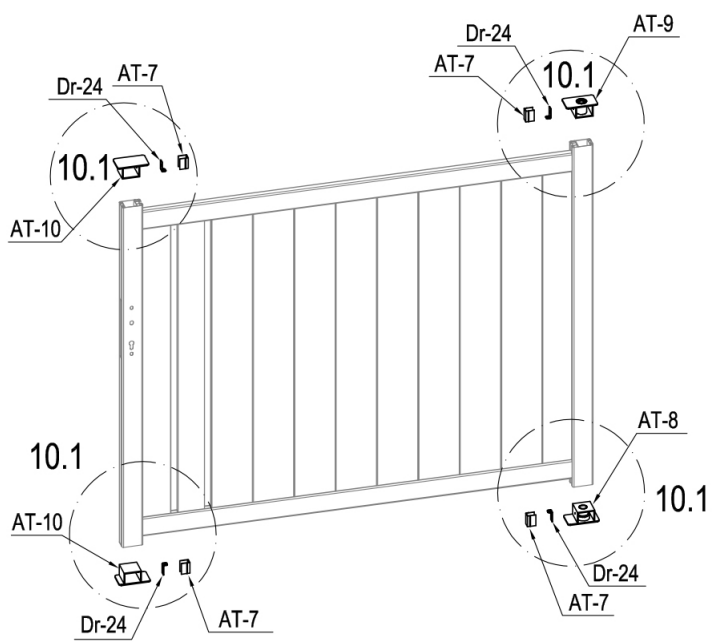

	AT-8	1
	AT-9	1
	AT-10	2
	Dr-24	4

	AT-7	4
	LR-G30	4
	LR-G31	4

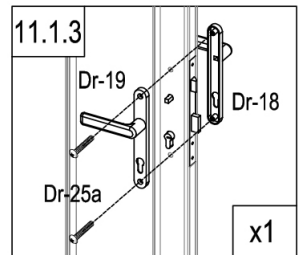
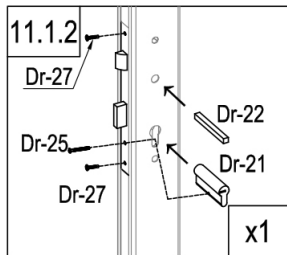
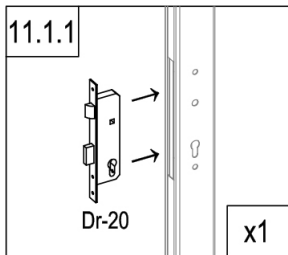
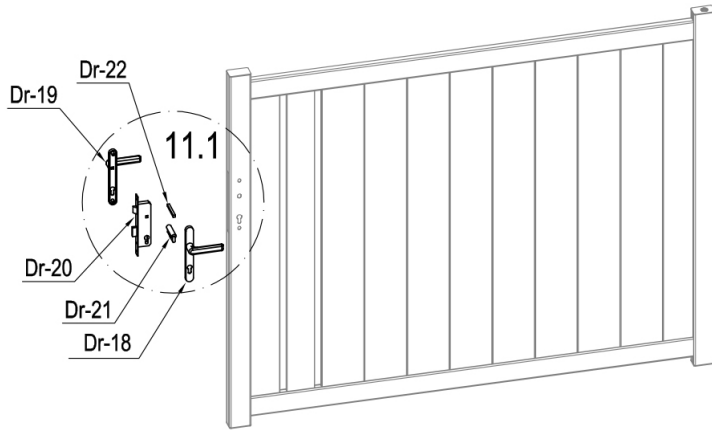





	Dr-20	1
	Dr-21	1
	Dr-22	1
	Dr-25	1

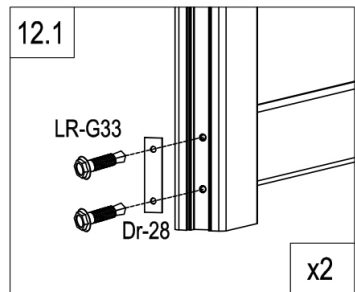
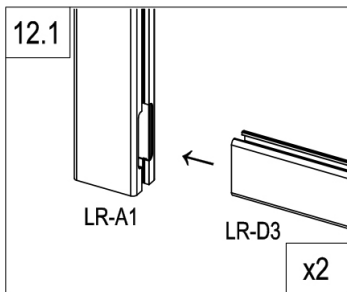
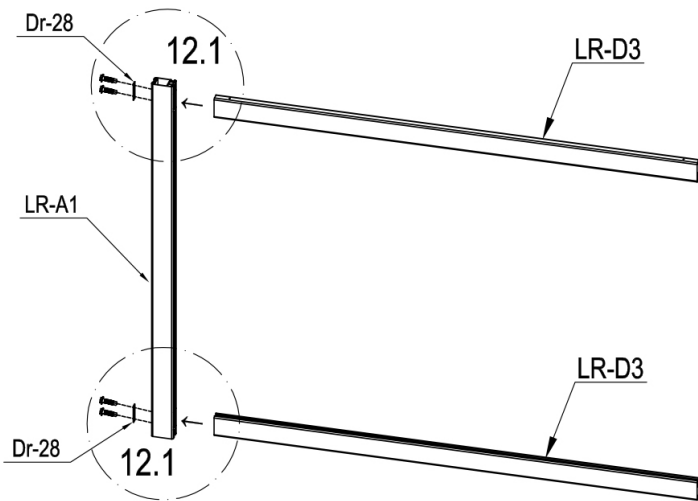

	Dr-18	1
	Dr-19	1
	Dr-25a	2
	Dr-27	2





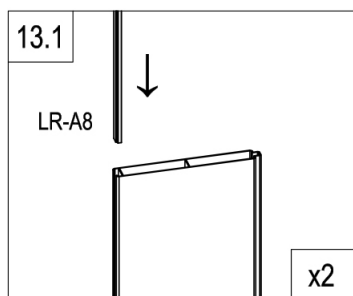
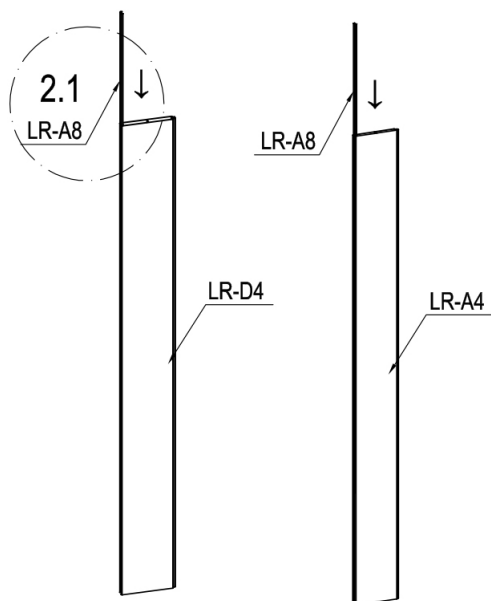

	LR-A1	1
	LR-D3	2
	Dr-28	2
	LR-G33	4



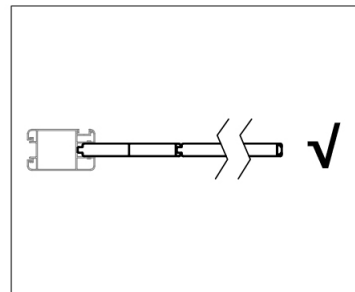
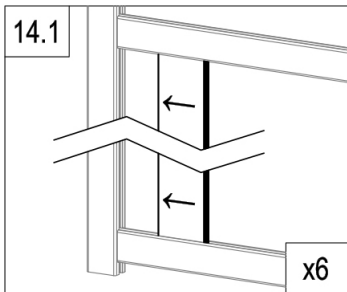
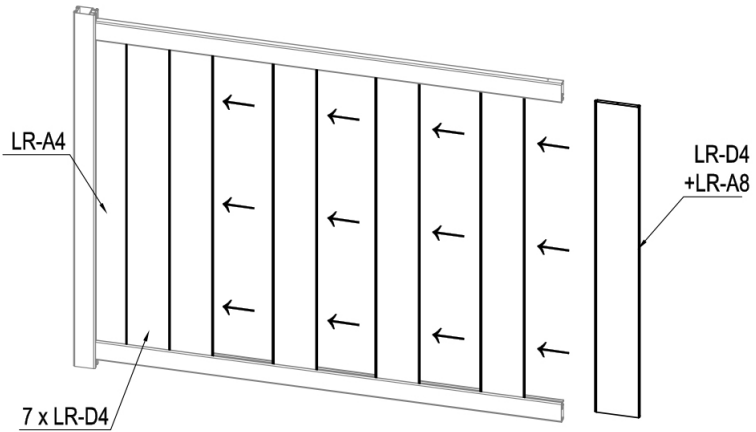

	LR-A8	2
	LR-D4	1
	LR-A4	1



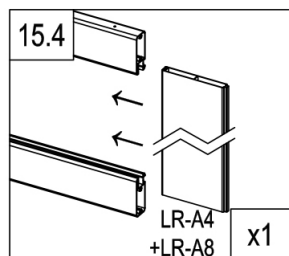
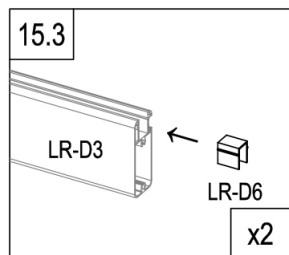
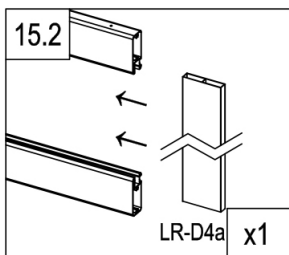
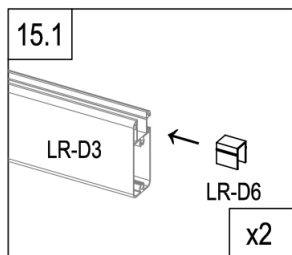
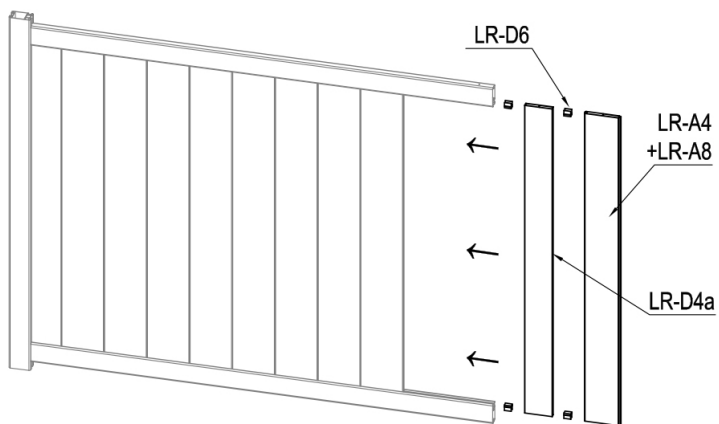

	LR-D4	7
	LR-A4	1



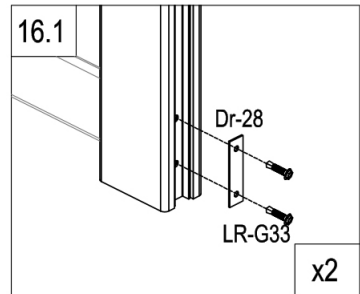
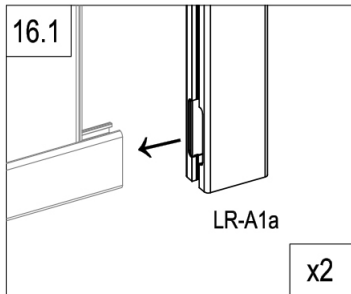
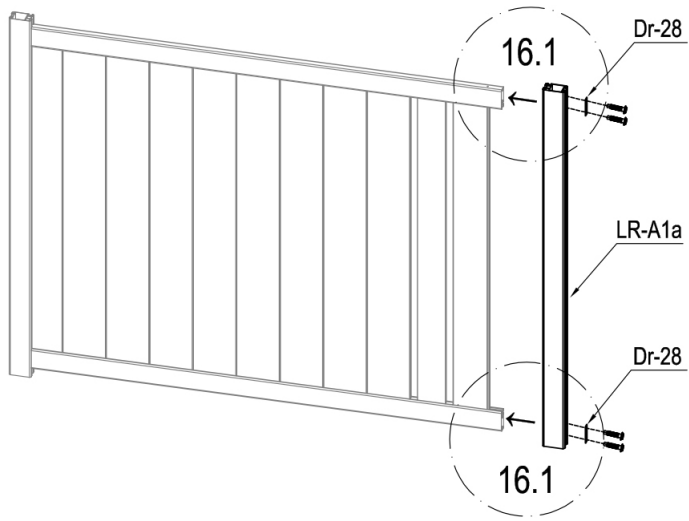

	LR-D4a	1
	LR-D6	4

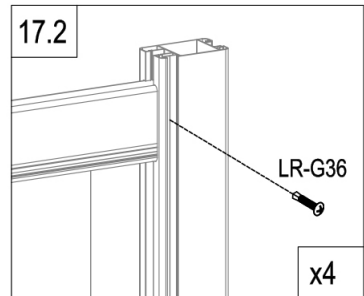
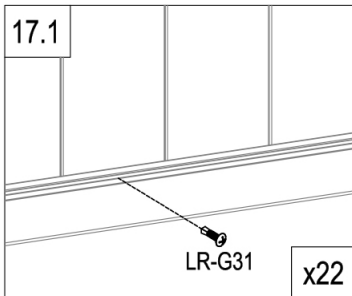
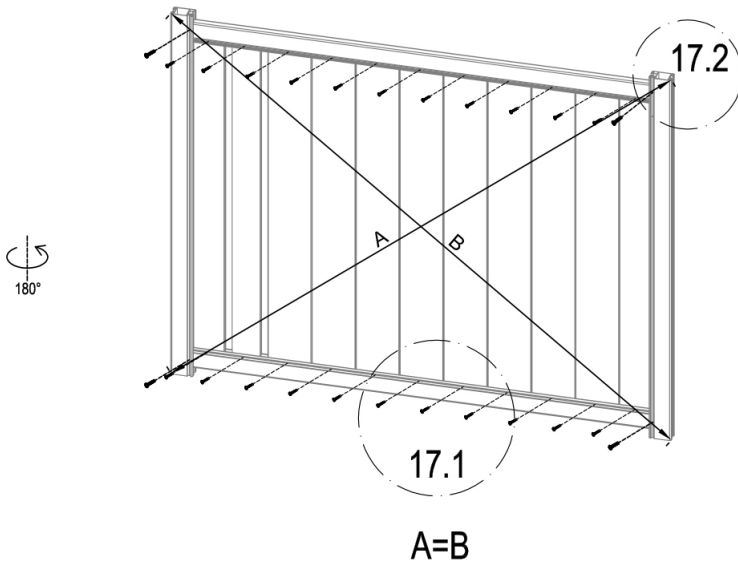

	LR-A1a	1
	Dr-28	2
	LR-G33	4



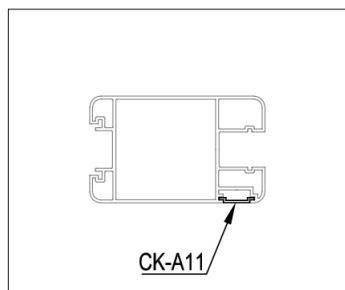
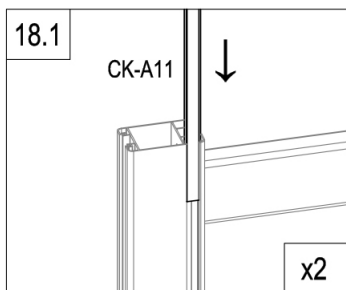
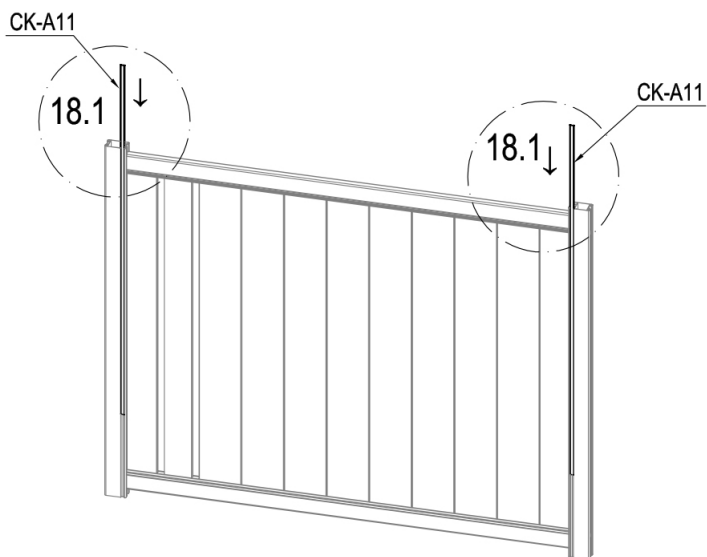

	LR-G31	22
	LR-G36	4



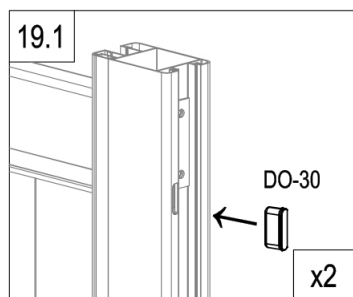
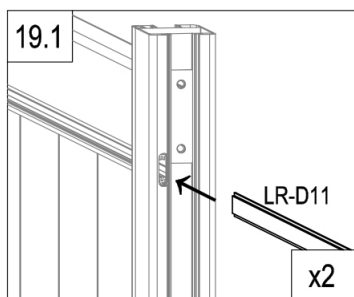
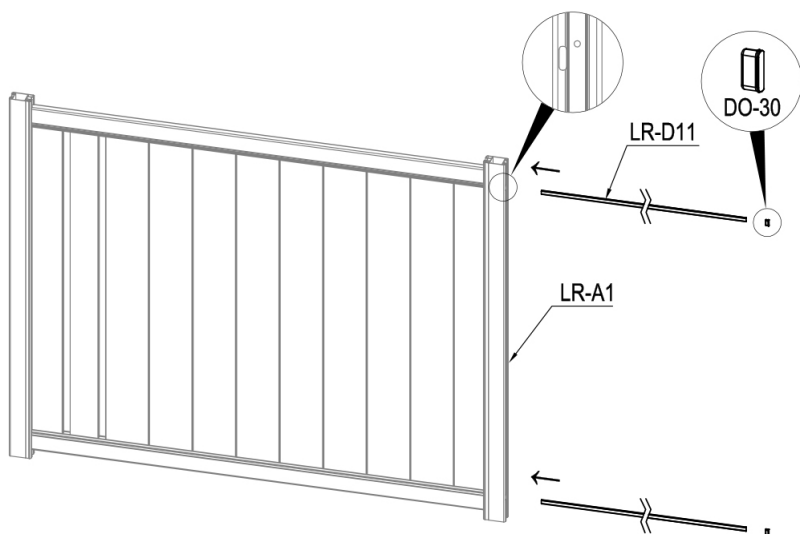

	CK-A11	2
---	--------	---





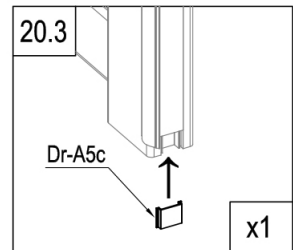
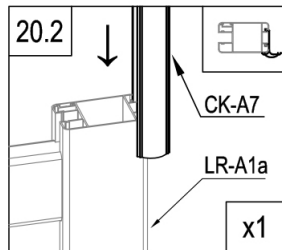
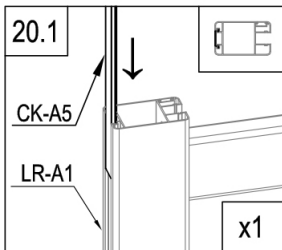
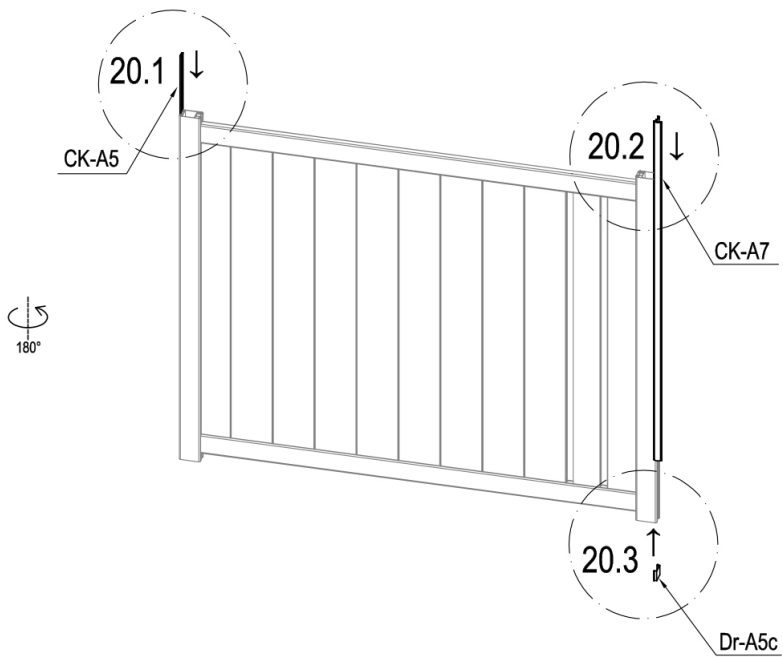

	LR-D11	2
	DO-30	2



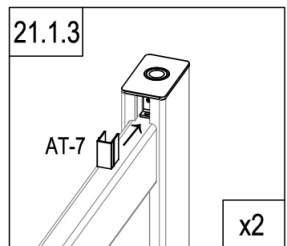
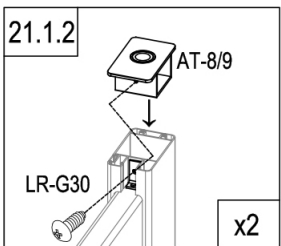
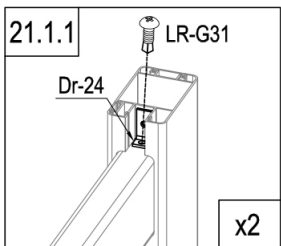
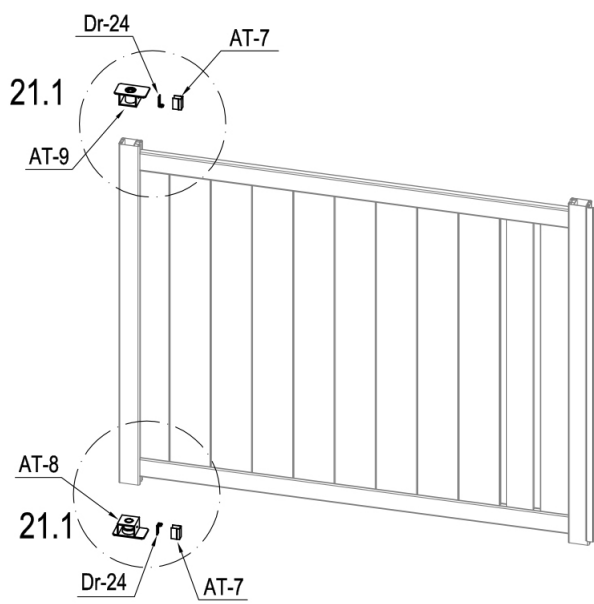



	CK-A5	1
	Dr-A5c	1
	CK-A7	1



	AT-8	1
	AT-9	1
	Dr-24	2

	AT-7	2
	LR-G30	2
	LR-G31	2

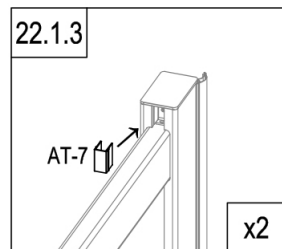
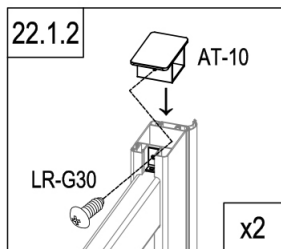
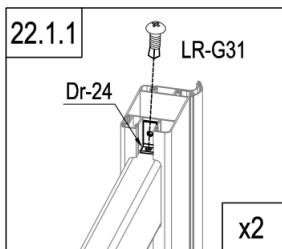
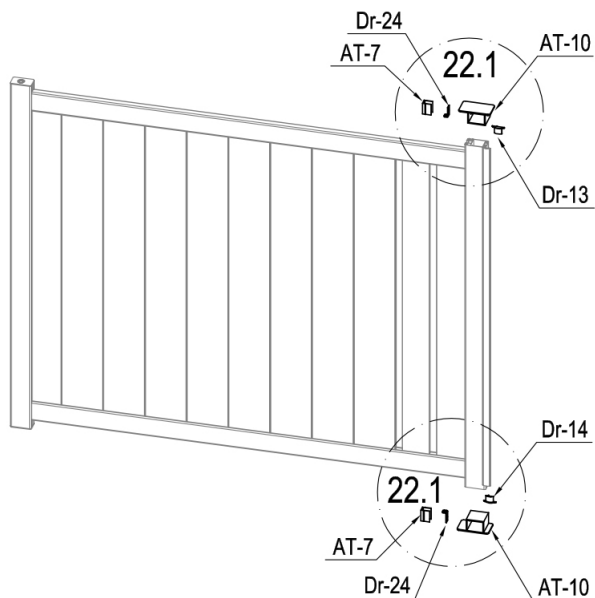

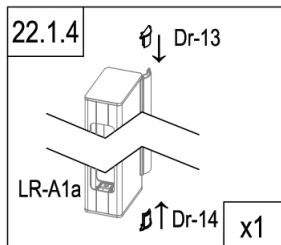

	AT-10	2
	Dr-24	2
	AT-7	2
	Dr-13	1



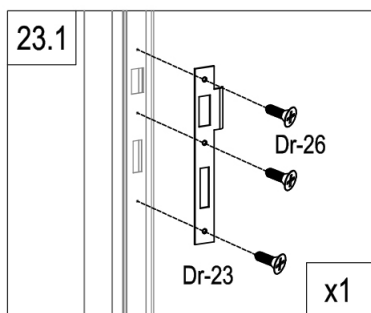
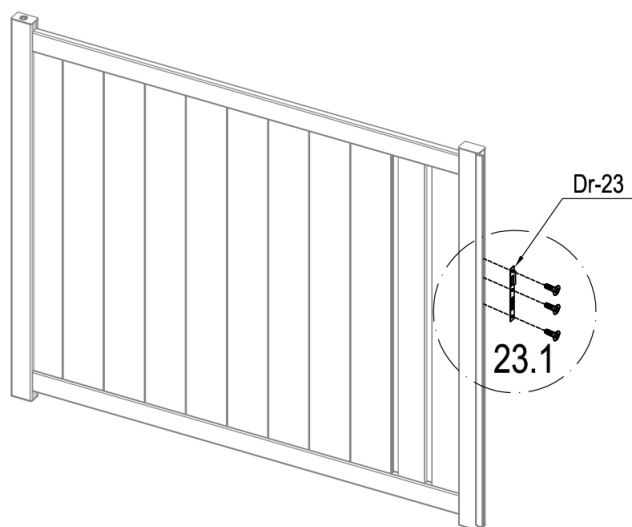

	Dr-14	1
	LR-G30	2
	LR-G31	2

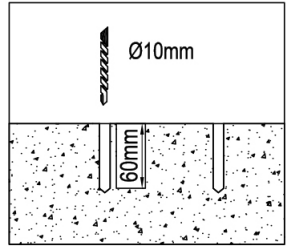
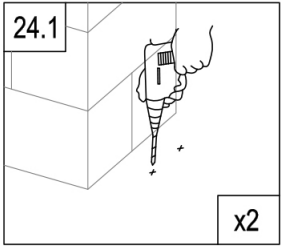
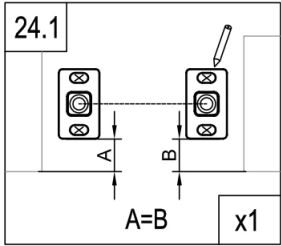
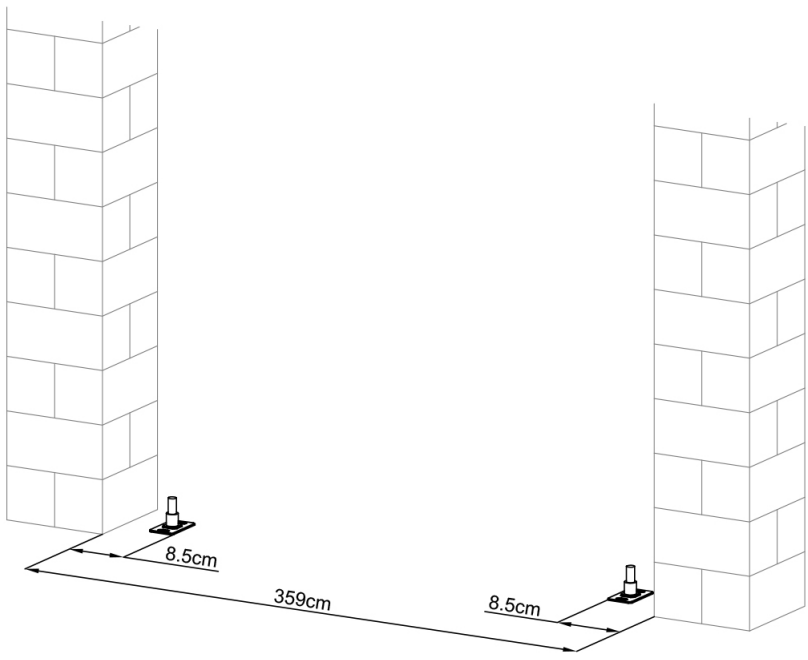

	Dr-23	1
	Dr-26	3



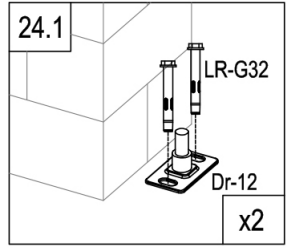

	Dr-12	2
	LR-G32	4



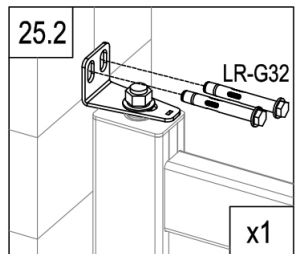
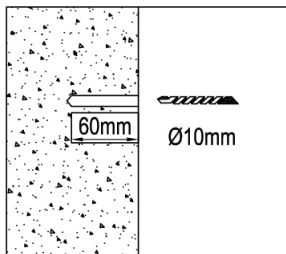
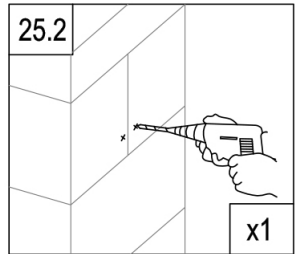
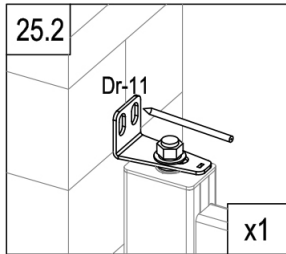
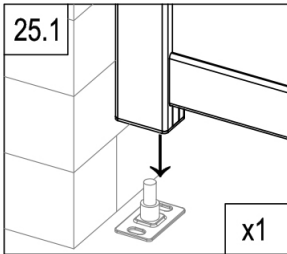
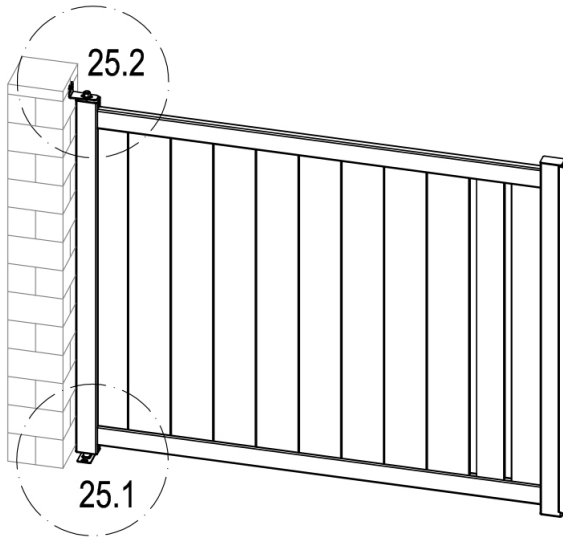

# CASANOVO

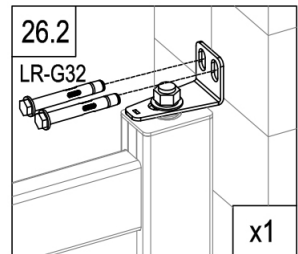
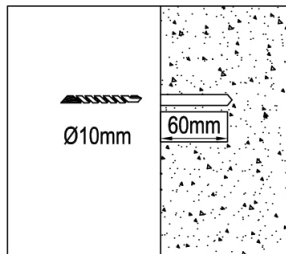
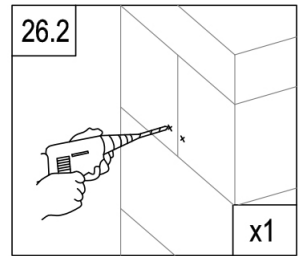
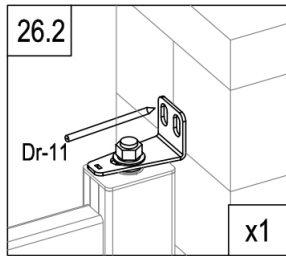
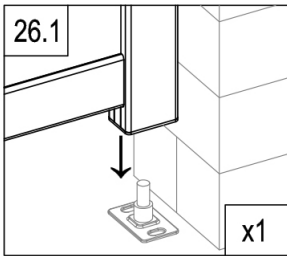
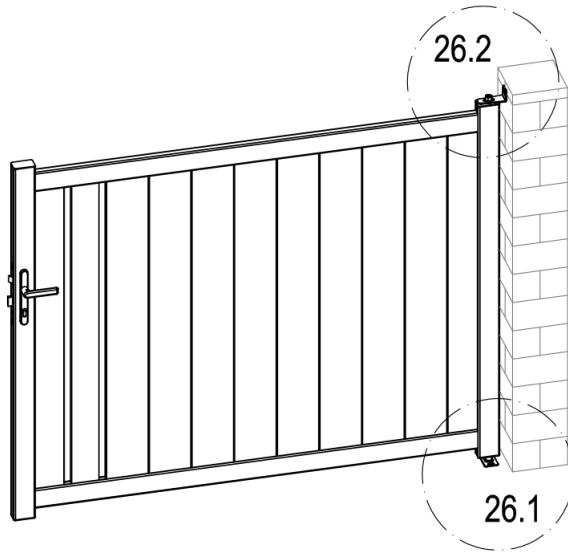

	Dr-11	1
	LR-G32	2



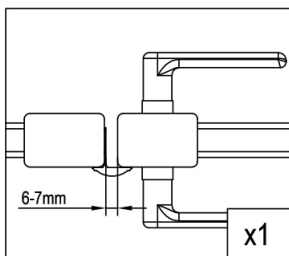
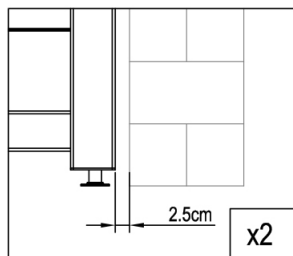
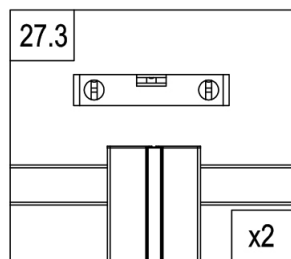
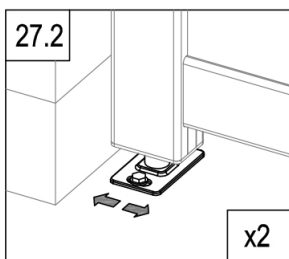
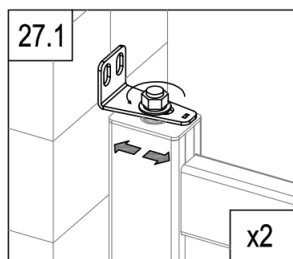
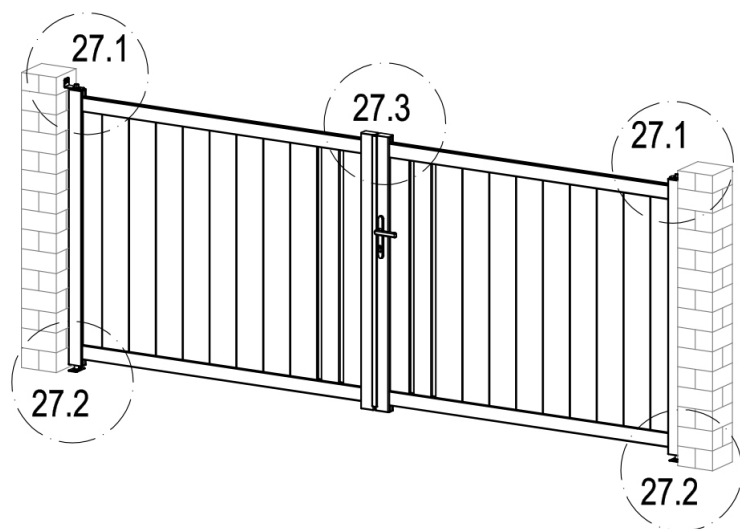

	Dr-11	1
	LR-G32	2



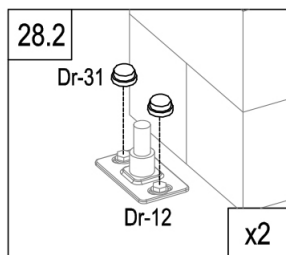
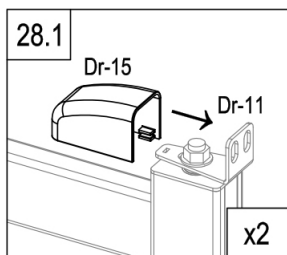
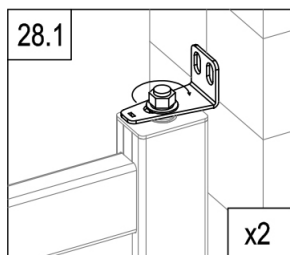
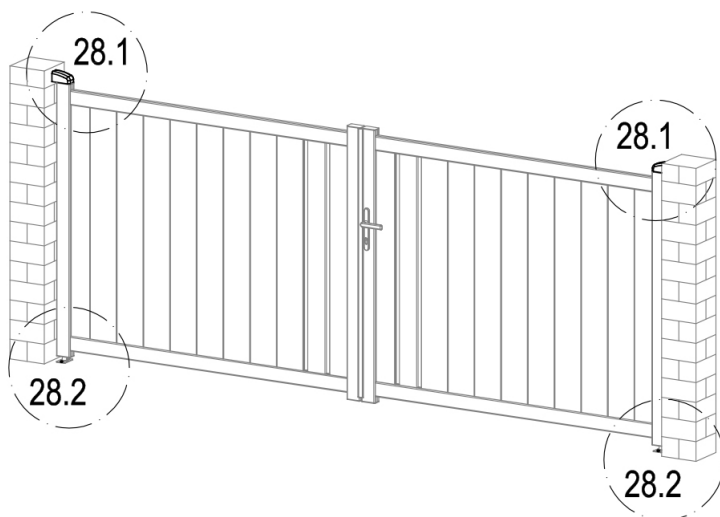





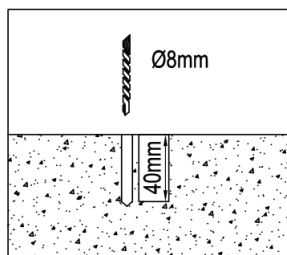
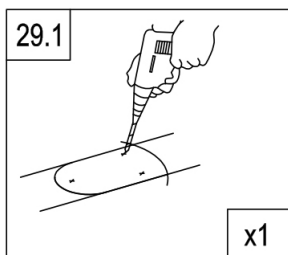
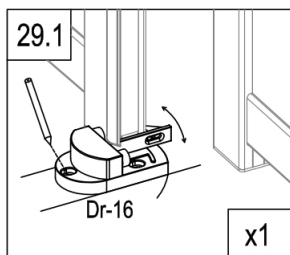
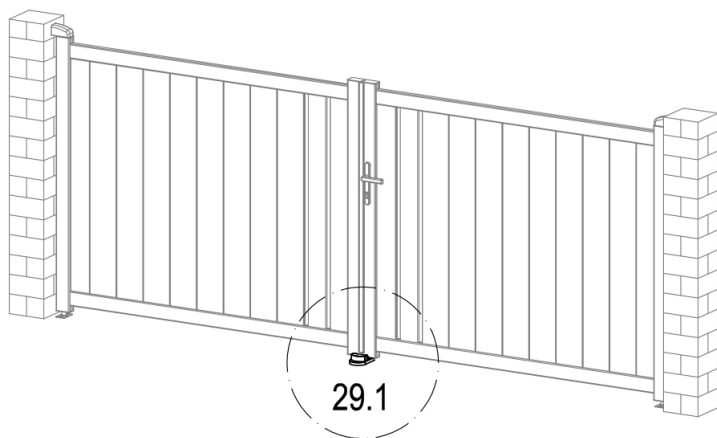

	Dr-15	2
	Dr-31	4

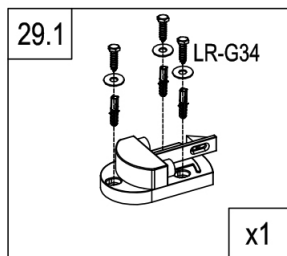

	Dr-16	1
	LR-G34	3
	LR-G35	3

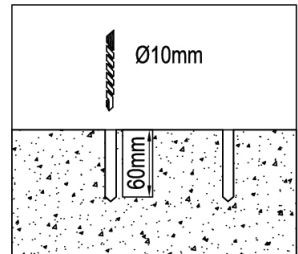
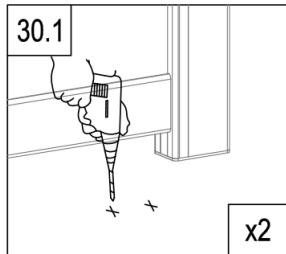
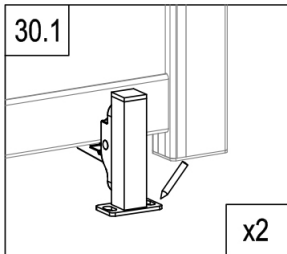
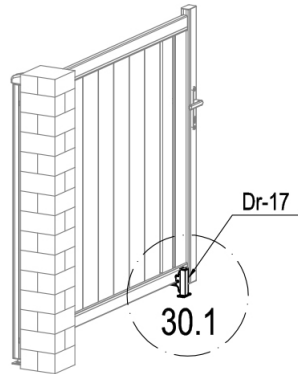
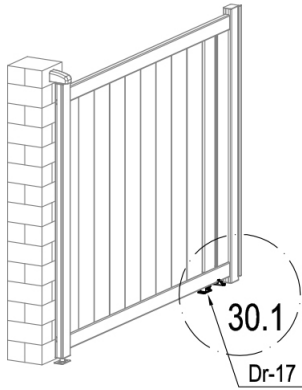



	LR-G32	4
	Dr-17	2

