

CASANOVO

MEIJE 340B140

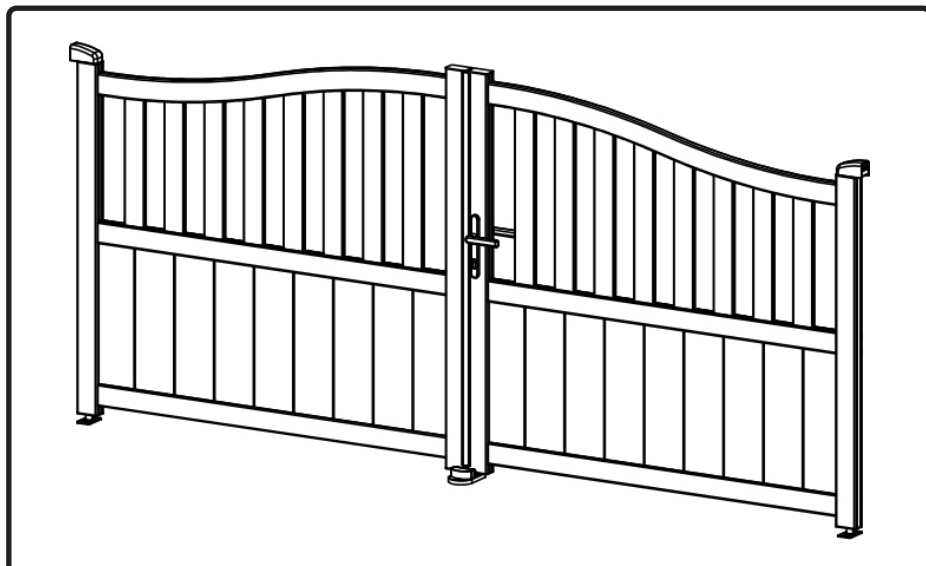

STI-000788 [x1]

STI-000789 [x1]



5-7H



X 2





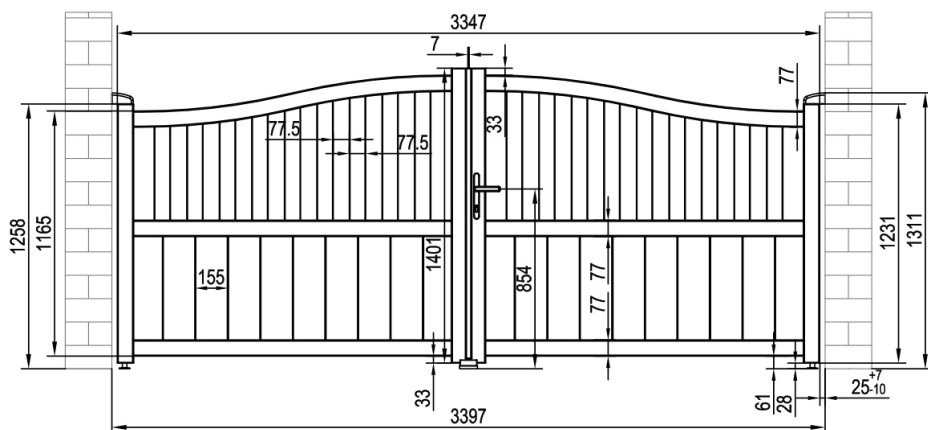

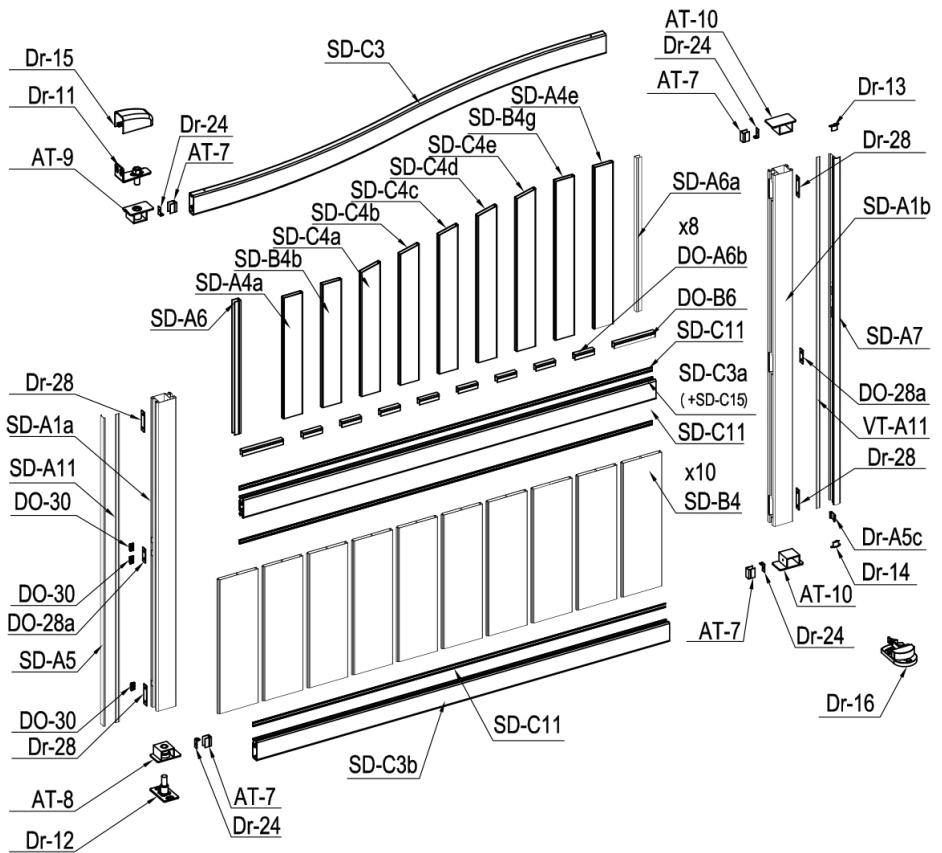

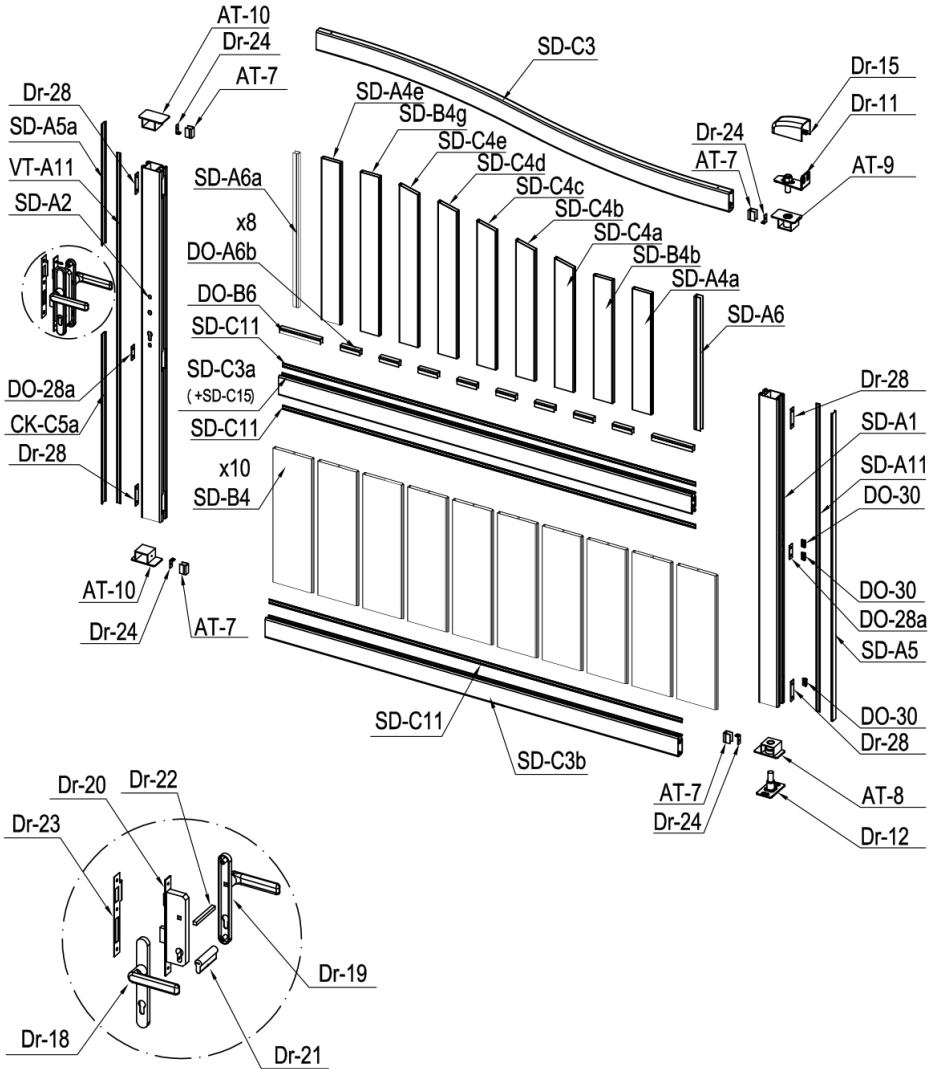



































INSTRUCTION MANUAL / NOTICE DE MONTAGE / MONTAGEANLEITUNG / MANUAL DE MONTAJE / MANUAL DE MONTAGEM / MANUALE DI MONTAGGIO /
MONTAGEHANDLEIDING / INSTRUKCJA MONTAŻU / KÄYTTÖOHJEET / BRUKSANVISNING / BRUGSANVISNING / INSTRUCȚIUNI DE ASAMBLARE /
NAVODILA ZA SESTAVLJANJE / NÁVOD NA MONTÁŽ / ÖSSZESZERELÉSI ÚTMUTATÓ / NÁVOD K MONTÁŽI / UPUTE ZA INSTALACIJU /
ΟΔΗΓΙΕΣ ΣΥΝΑΡΜΟΛΟΓΗΣΗΣ / SURINKIMO INSTRUKCIJOS / MONTÁŽAS INSTRUKCIJAS







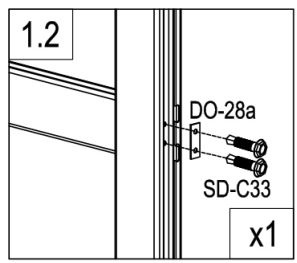
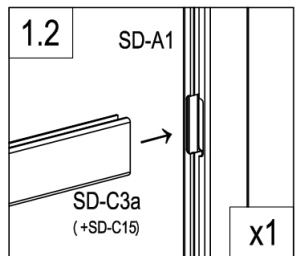
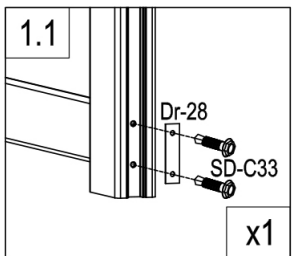
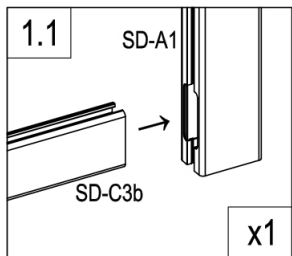
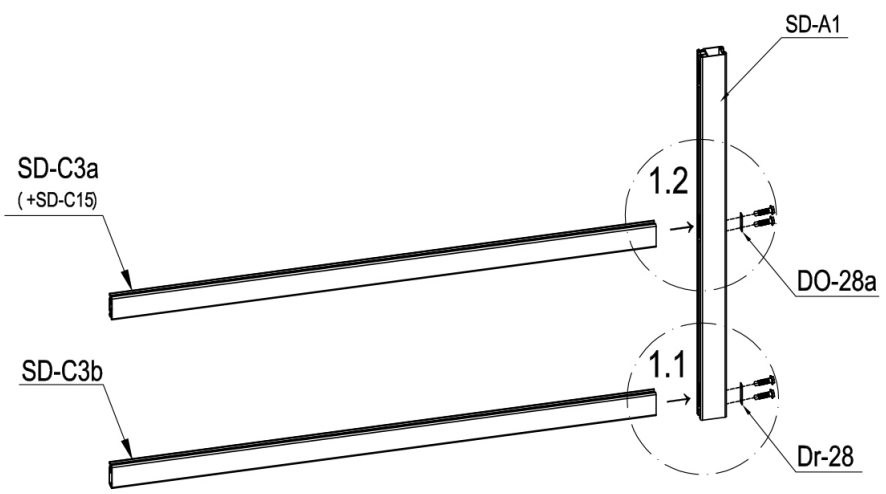

CASANOVO

IMAGE	NO.	L.(mm)	QTY	IMAGE	NO.	L.(mm)	QTY
	SD-A1	1225	1		AT-9		2
	SD-A1a	1225	1		AT-10		4
	SD-A1b	1395	1		Dr-11		2
	SD-A2	1395	1		Dr-12		2
	SD-C3b	1647	2		Dr-13		1
	SD-C3a (+SD-C15)	1647	2		Dr-14		1
	SD-C3	1647	2		Dr-15		2
	SD-B4	532	20		Dr-16		1
	SD-A4a	482	2		Dr-17		2
	SD-B4b	490	2		Dr-31		4
	SD-C4a	513	2		DO-30		6
	SD-C4b	540	2		Dr-18		1
	SD-C4c	572	2		Dr-19		1
	SD-C4d	604	2		Dr-20		1
	SD-C4e	627	2		Dr-21		1
	SD-B4g	633	2		Dr-22		1
	SD-A4e	644	2		Dr-23		1
	SD-A5	1225	2		Dr-25		1
	SD-A5a	481.5	1		Dr-25a		2
	CK-C5a	673	1		Dr-26		3
	Dr-A5c	19.5	1		Dr-27		2
	VT-A11	1395	2		Dr-24		8
	SD-A11	1225	2		Dr-28		8
	SD-C11	1647	6		DO-28a		4
	AT-7	29.5	8		SD-C30		8
	SD-A6	441	2		SD-C31		66
	SD-A6a	611	2		SD-C32		12
	DO-B6	163	4		SD-C33		24
	DO-A6b	77.5	16		SD-C34		3
	SD-A7	1375	1		SD-C35		3
	AT-8		2		SD-C36		12



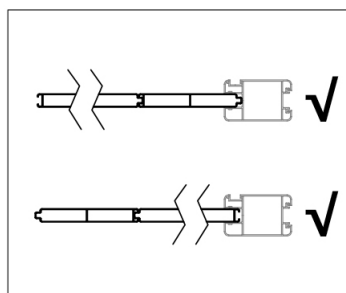
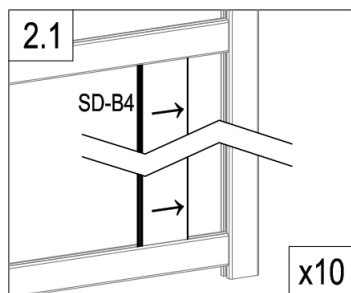
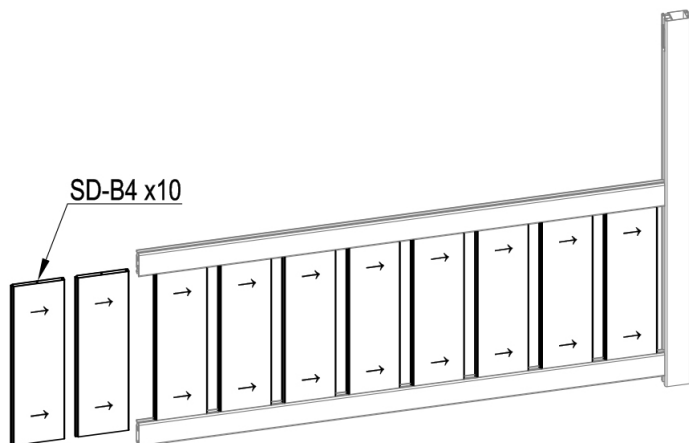



	SD-C3a (+SD-C15)	1
	SD-A1	1
	SD-C3b	1
	DO-28a	1
	Dr-28	1
	SD-C33	4

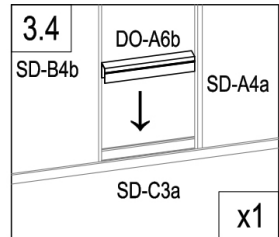
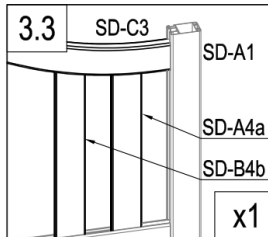
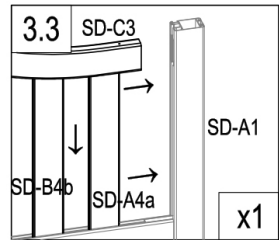
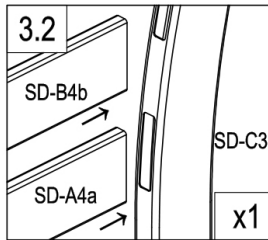
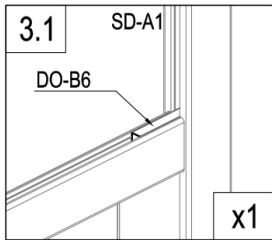
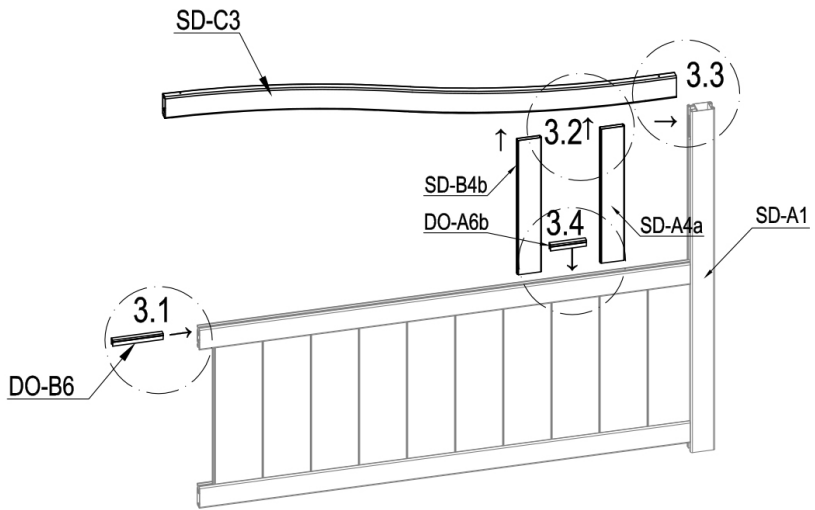



	SD-B4	10
---	-------	----



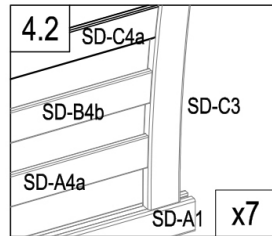
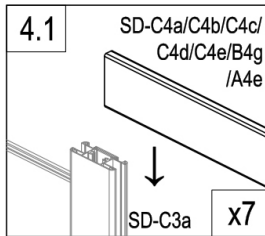
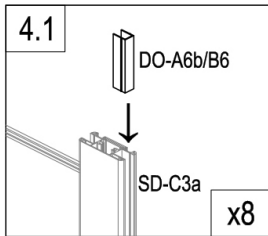
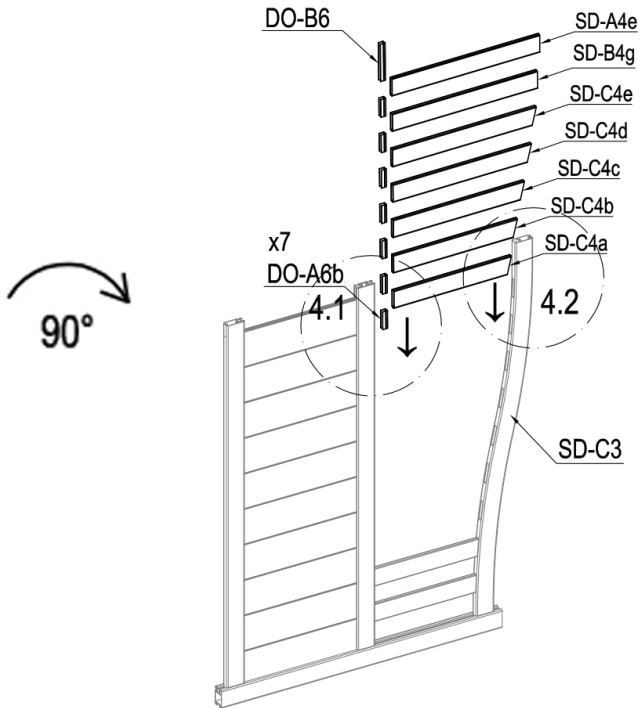



	SD-A4a	1
	SD-B4b	1
	DO-A6b	1
	DO-B6	1
	SD-C3	1

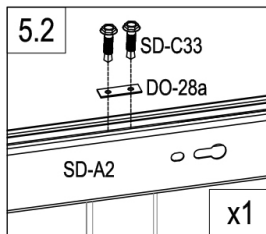
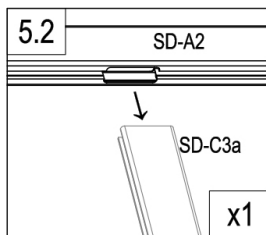
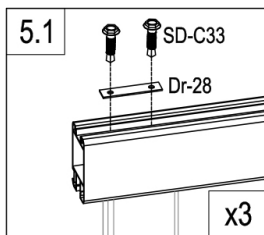
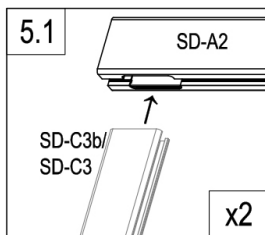
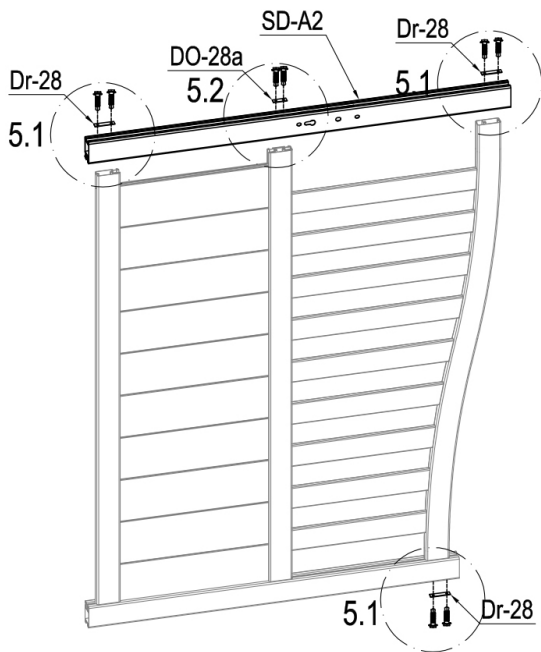



	SD-C4a	1	 	SD-B4g	1
	SD-C4b	1		SD-A4e	1
	SD-C4c	1		DO-B6	1
	SD-C4d	1		DO-A6b	7
	SD-C4e	1			



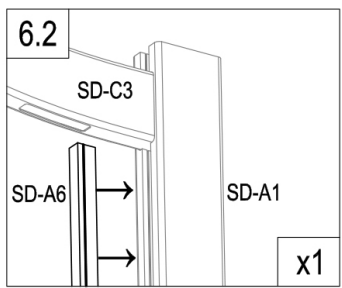
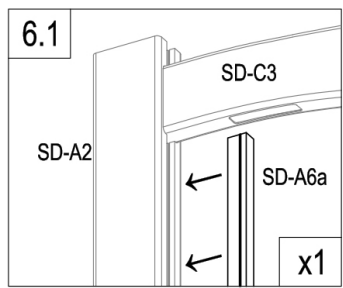
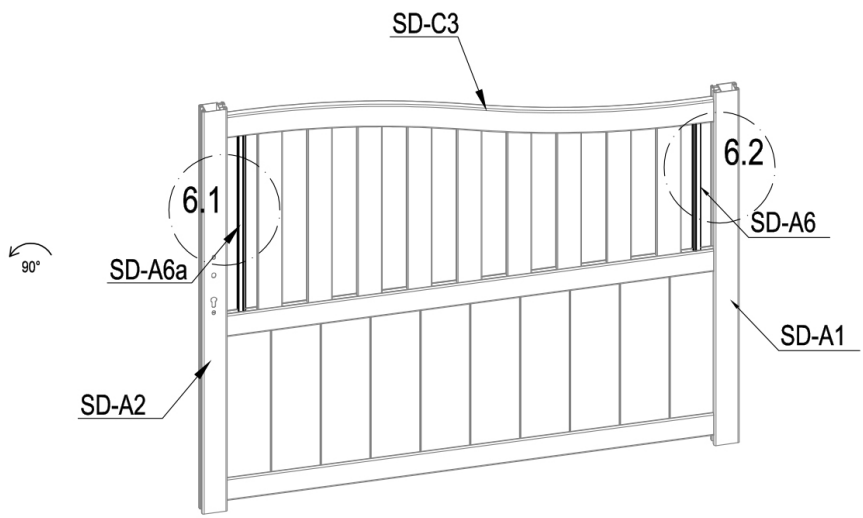

	SD-A2	1
	DO-28a	1
	Dr-28	3
	SD-C33	8

CASANOVO

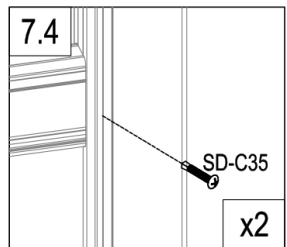
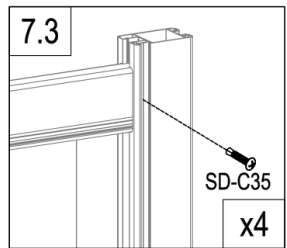
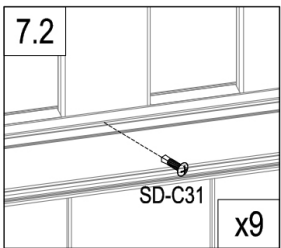
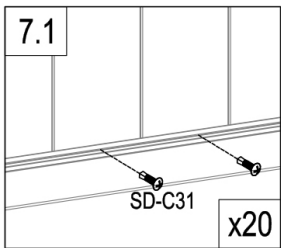
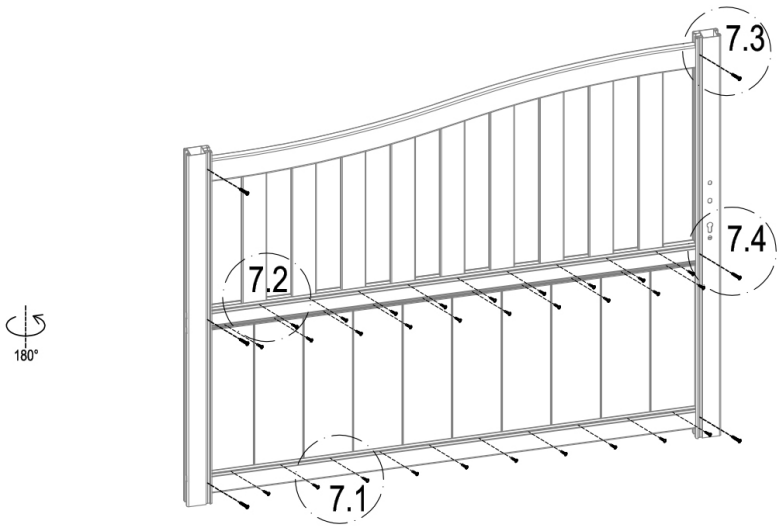

	SD-A6	1
	SD-A6a	1



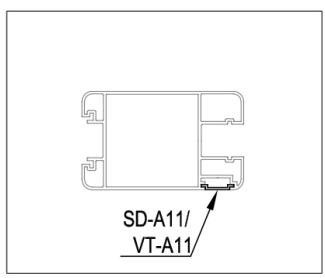
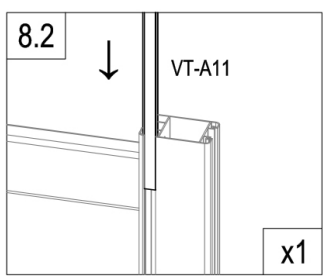
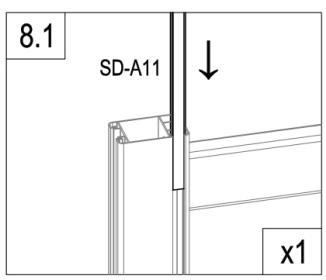
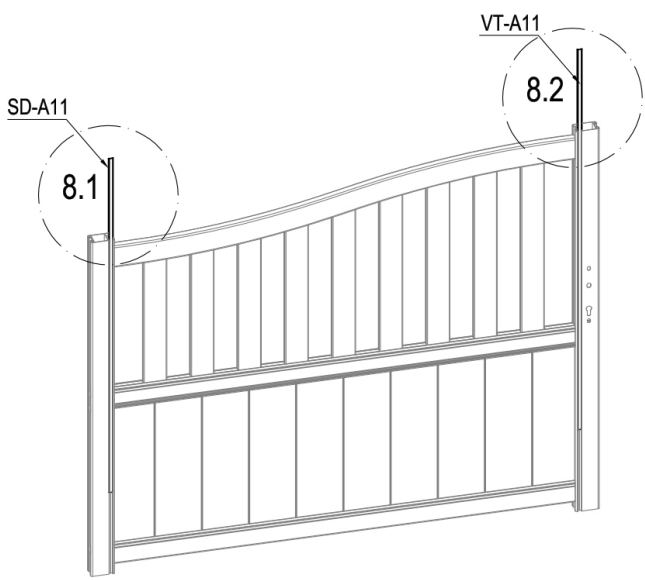

	SD-C31	29
	SD-C35	6

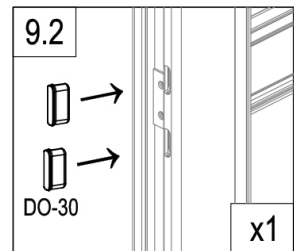
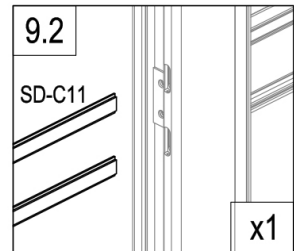
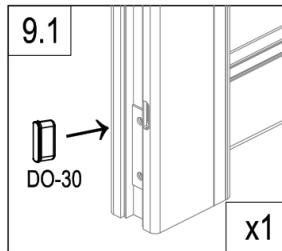
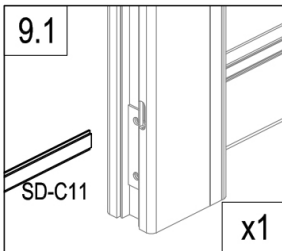
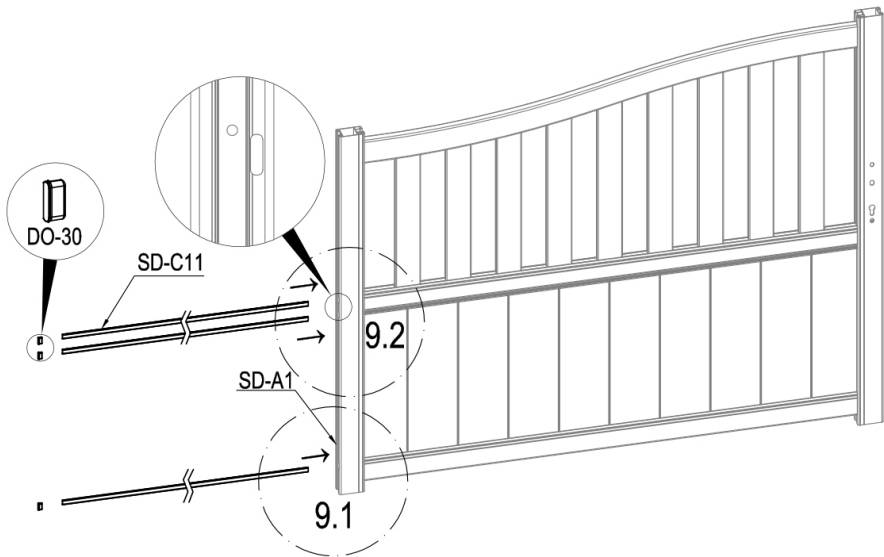

	SD-A11	1
	VT-A11	1



	SD-C11	3
	DO-30	3

CASANOVA

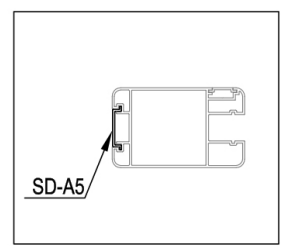
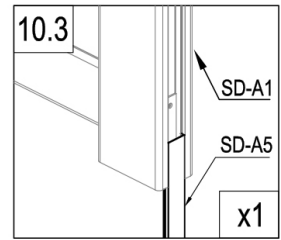
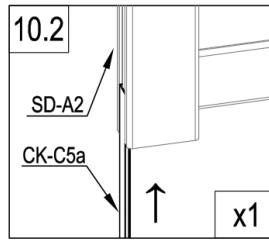
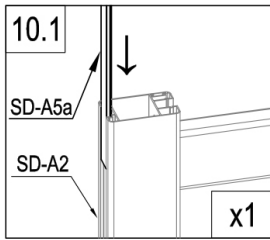
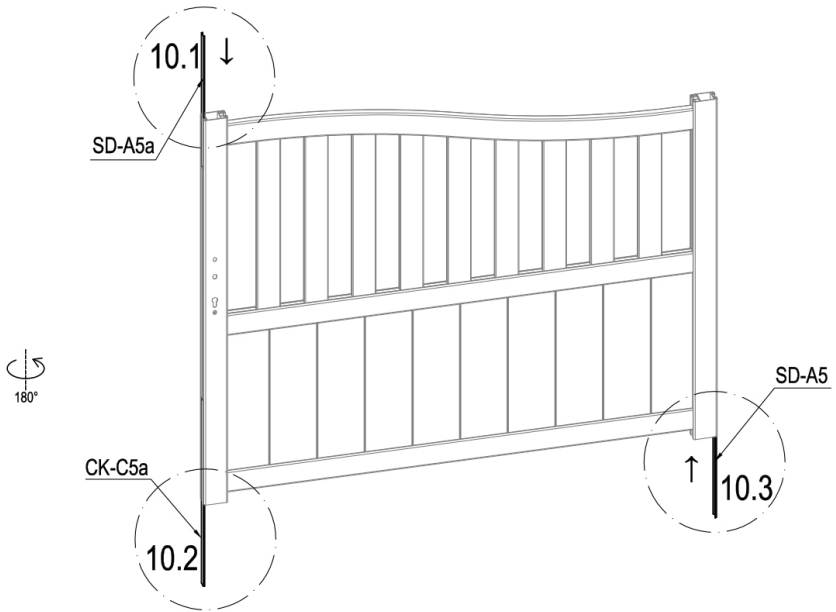

	SD-A5	1
	SD-A5a	1
	CK-C5a	1



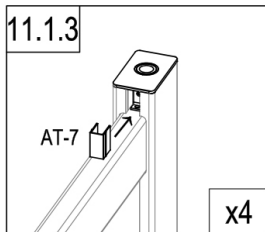
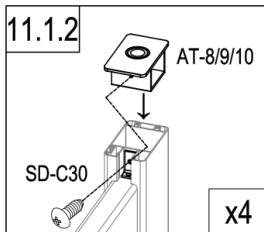
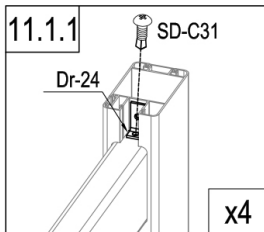
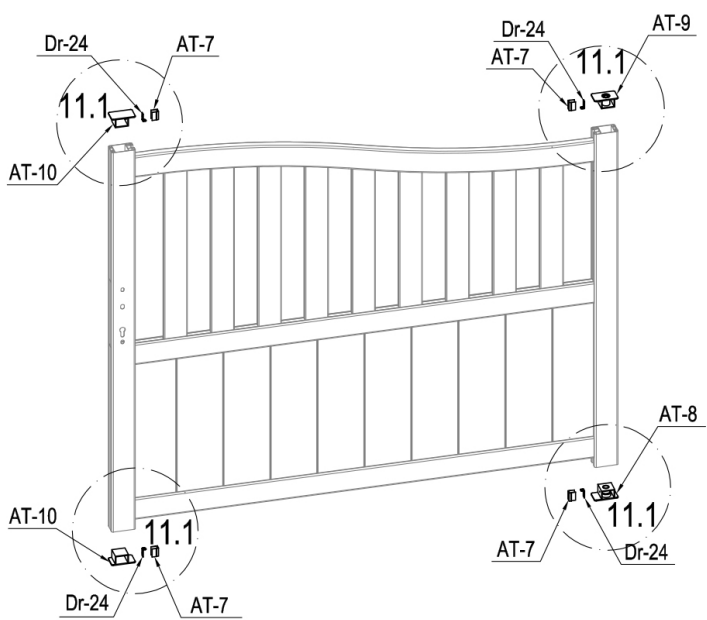

CASANOVA



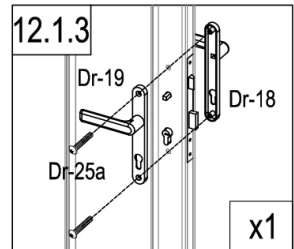
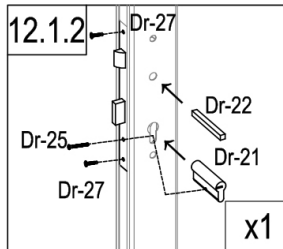
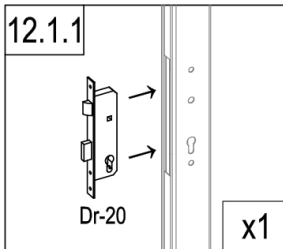
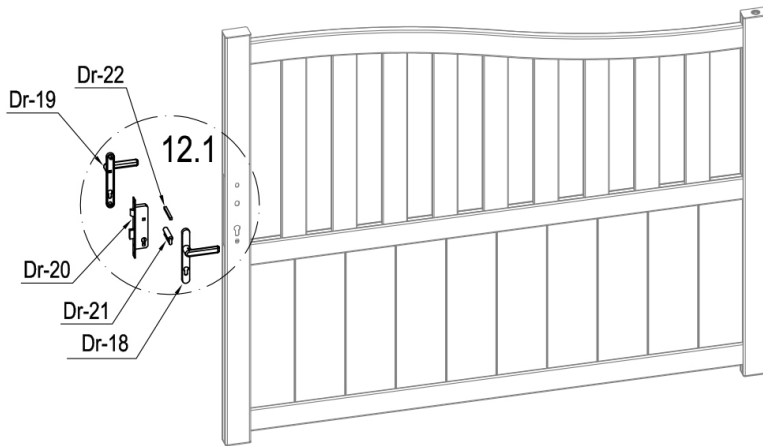

	AT-8	1
	AT-9	1
	AT-10	2
	Dr-24	4

	AT-7	4
	SD-C30	4
	SD-C31	4



	Dr-20	1
	Dr-21	1
	Dr-22	1
	Dr-25	1

	Dr-18	1
	Dr-19	1
	Dr-25a	2
	Dr-27	2

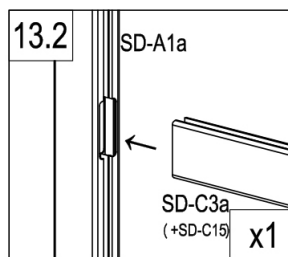
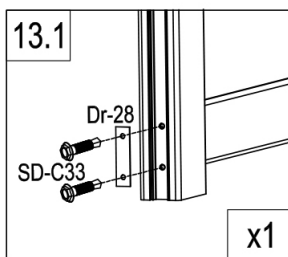
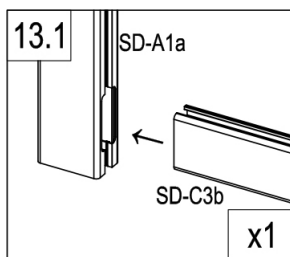
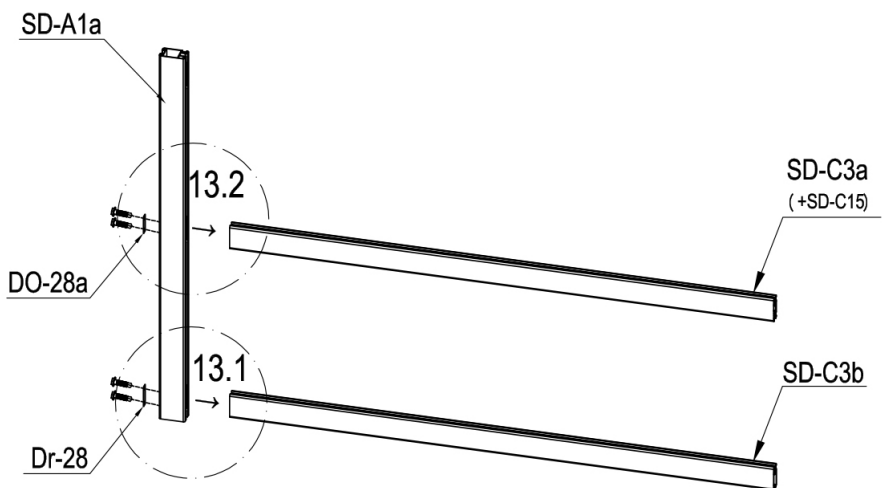

	SD-C3a (+SD-C15)	1
	SD-A1a	1
	SD-C3b	1
	DO-28a	1
	Dr-28	1
	SD-C33	4

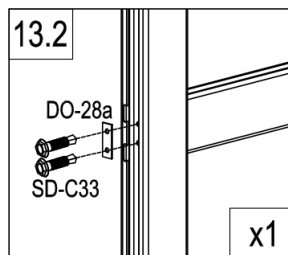

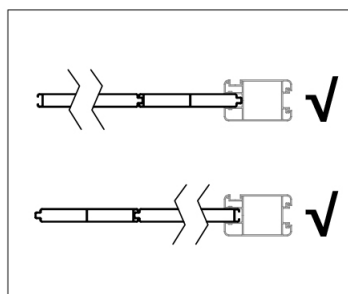
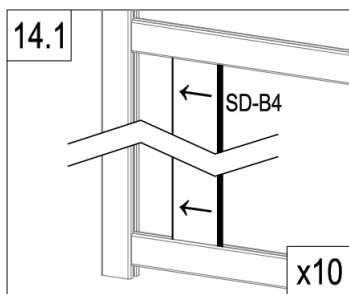
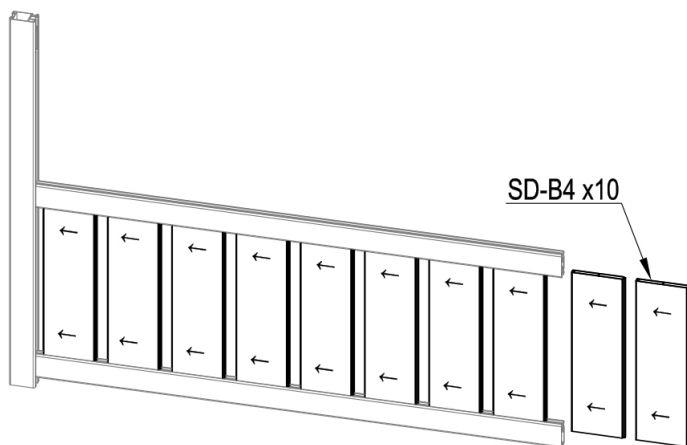





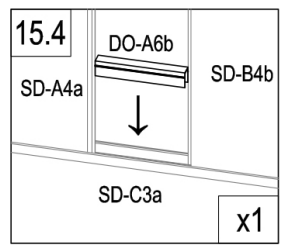
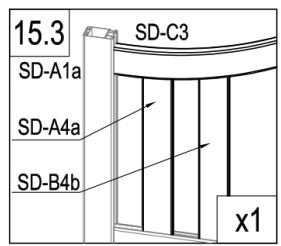
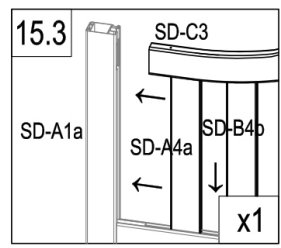
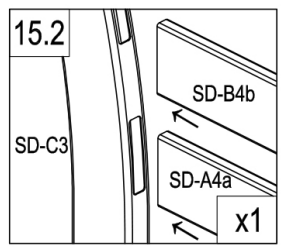
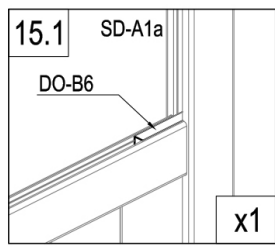
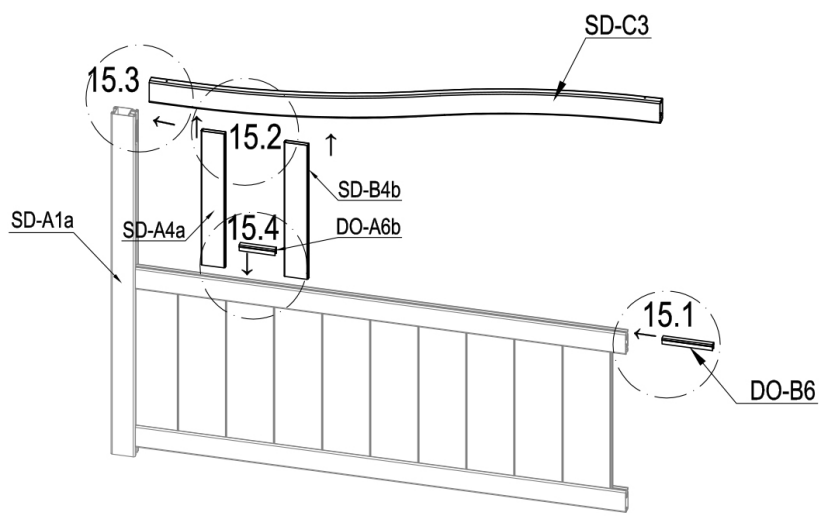

	SD-B4	10
---	-------	----

CASANOVO



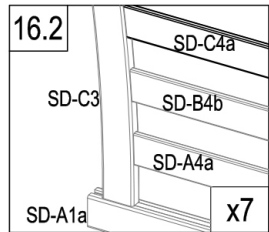
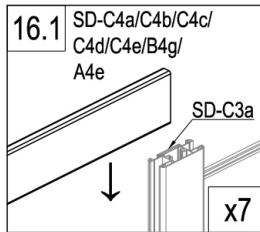
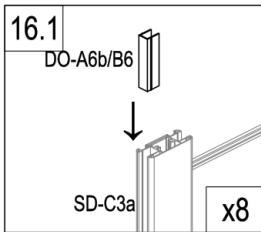
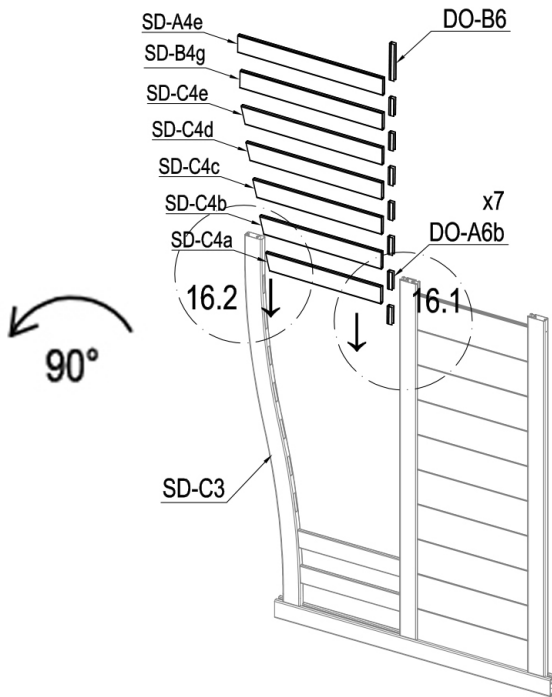



	SD-A4a	1
	SD-B4b	1
	DO-A6b	1
	DO-B6	1
	SD-C3	1

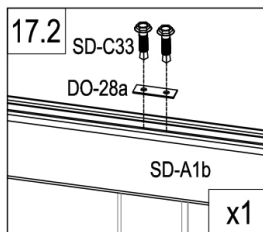
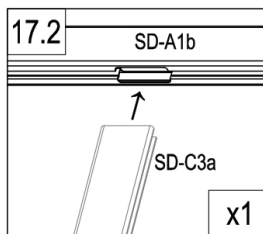
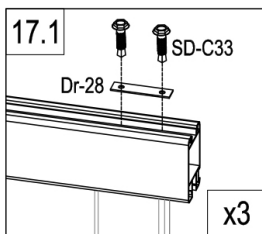
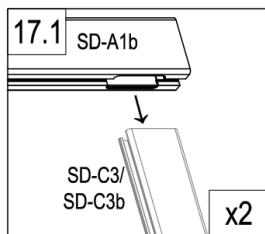
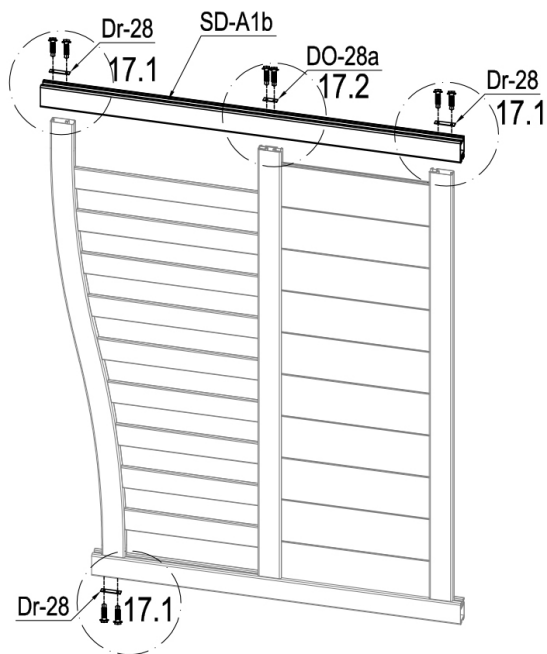



	SD-C4a	1		SD-B4g	1
	SD-C4b	1		SD-A4e	1
	SD-C4c	1		DO-B6	1
	SD-C4d	1		DO-A6b	7
	SD-C4e	1			



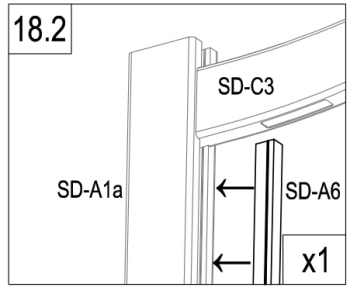
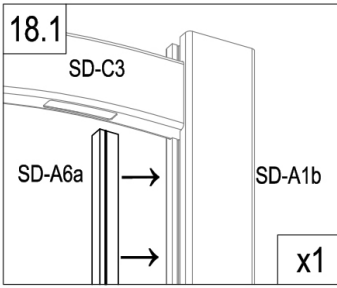
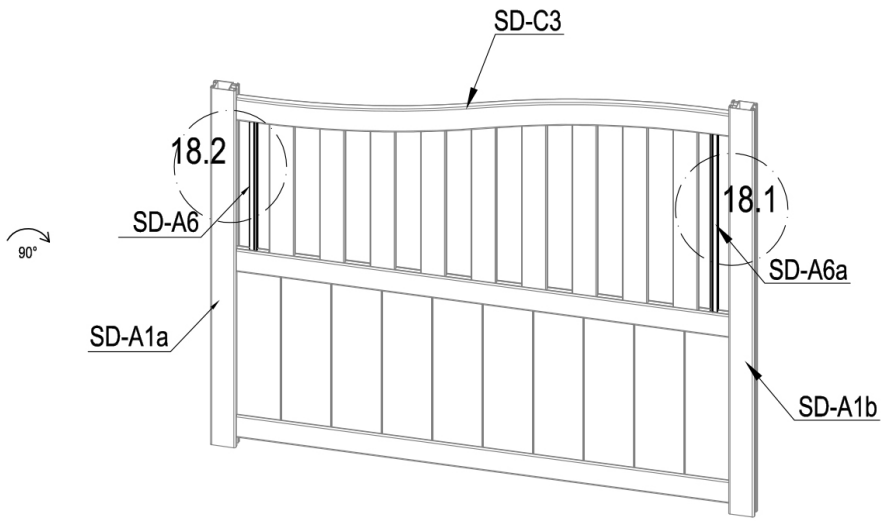

	SD-A1b	1
	DO-28a	1
	Dr-28	3
	SD-C33	8

CASANOVO

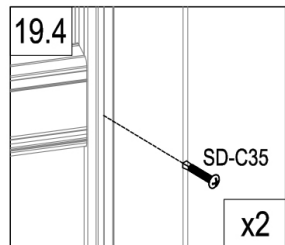
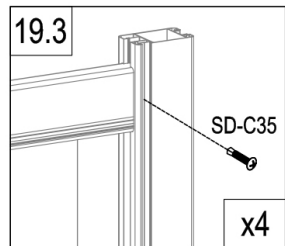
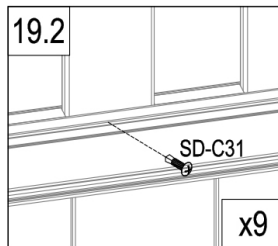
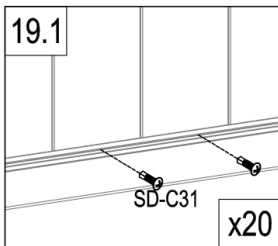
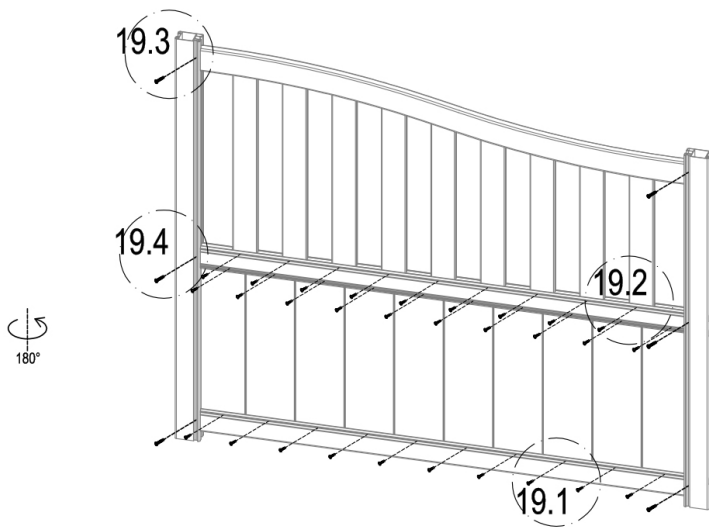

	SD-A6	1
	SD-A6a	1



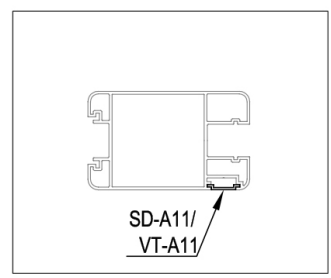
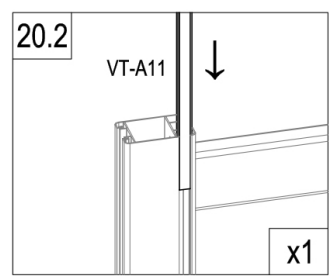
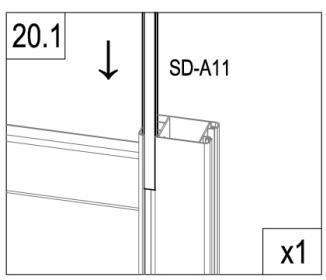
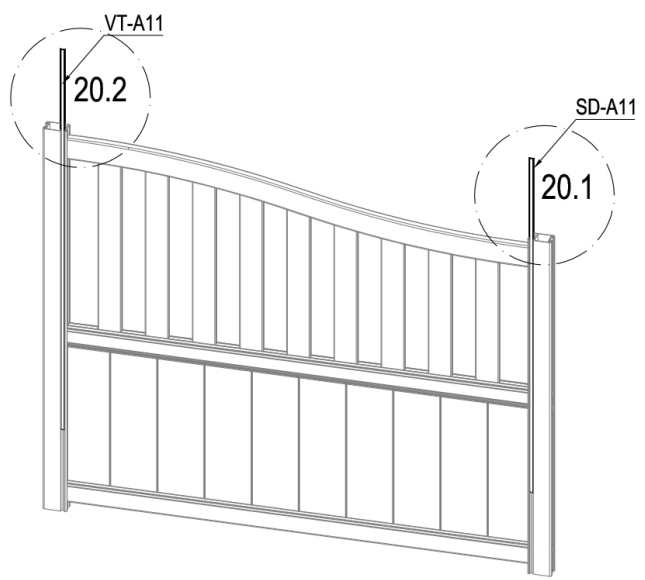

	SD-C31	29
	SD-C35	6



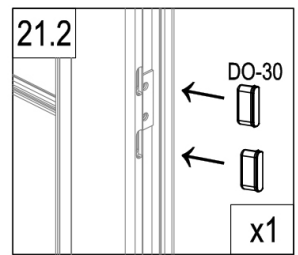
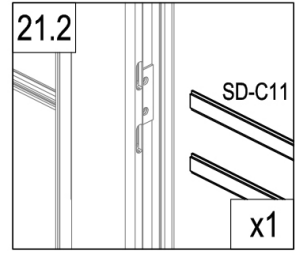
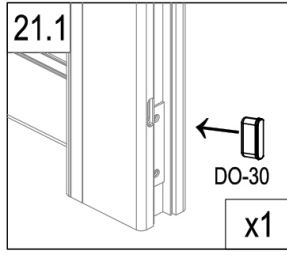
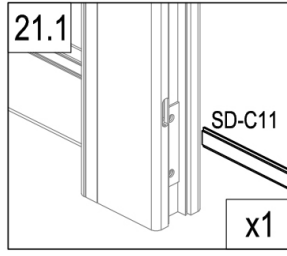
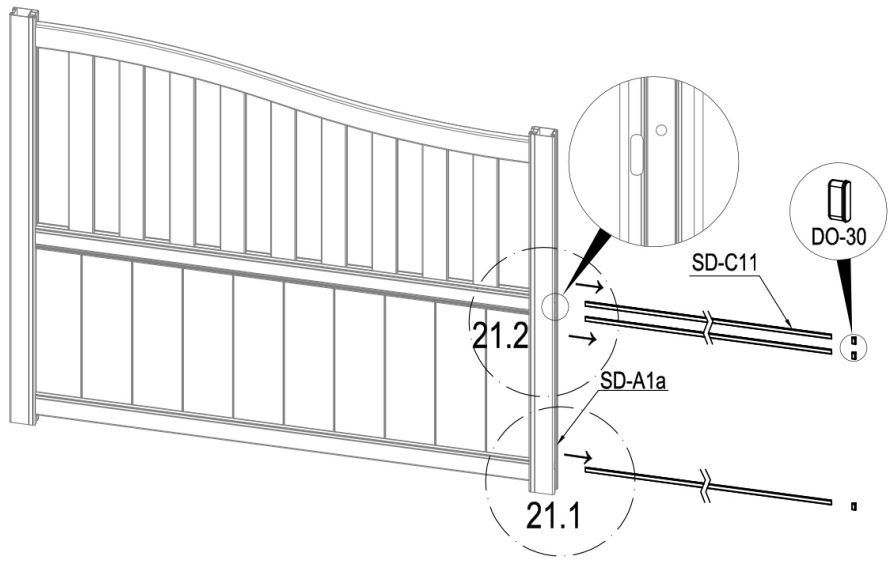

	SD-A11	1
	VT-A11	1

CASANOVA

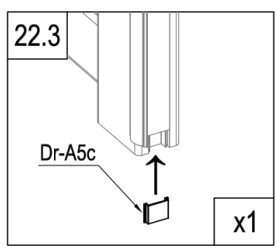
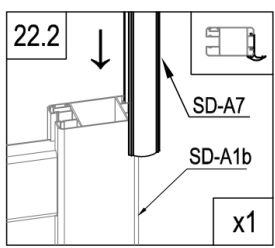
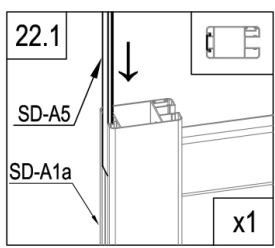
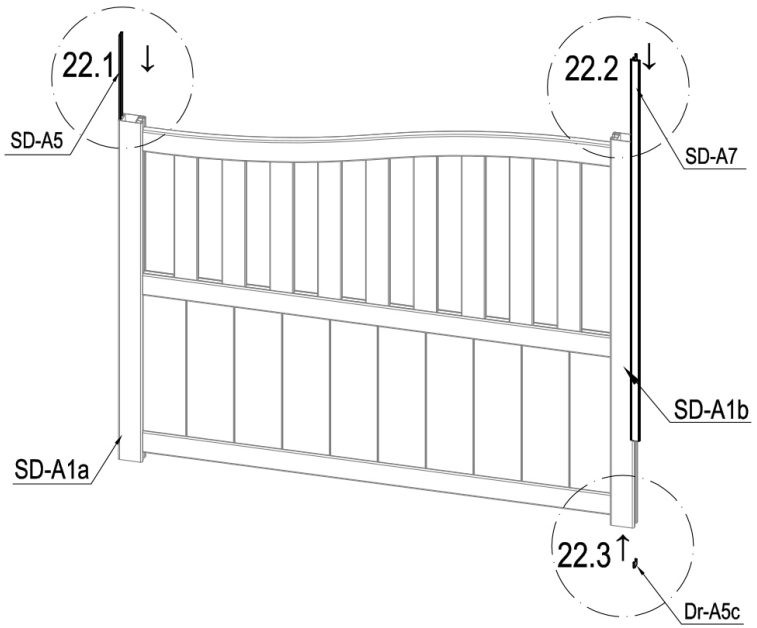

	SD-C11	3
	DO-30	3



	SD-A5	1
	Dr-A5c	1
	SD-A7	1

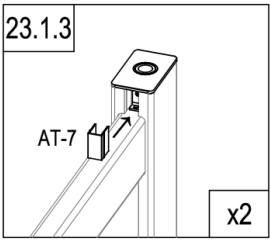
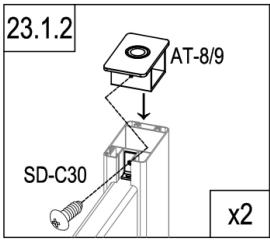
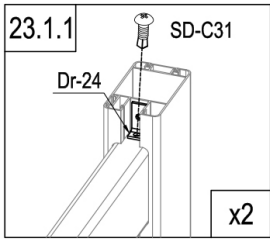
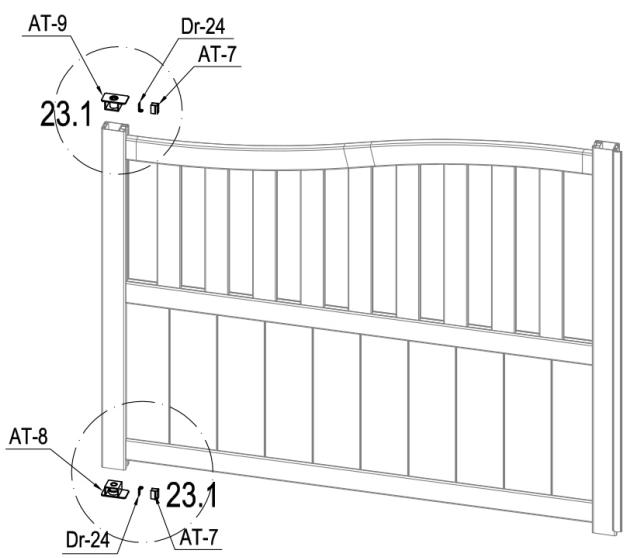

	AT-8	1
	AT-9	1
	Dr-24	2
	AT-7	2
	SD-C30	2
	SD-C31	2

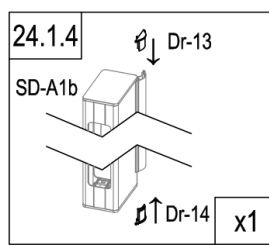
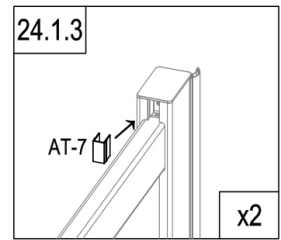
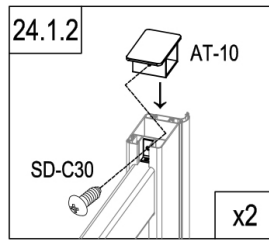
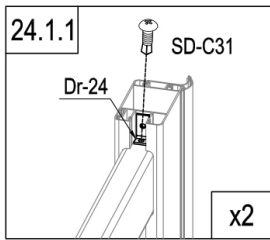
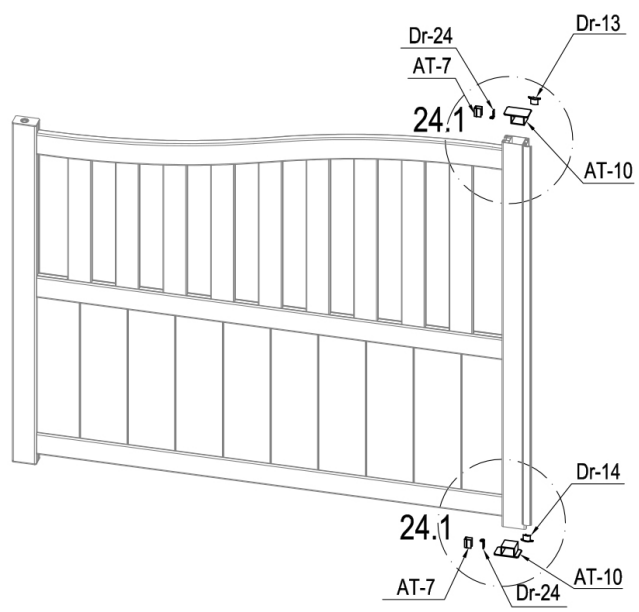

CASANOVA



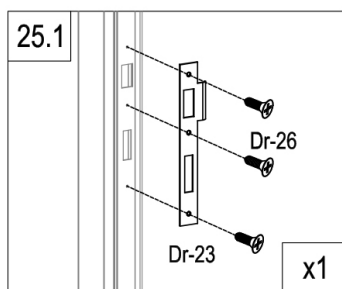
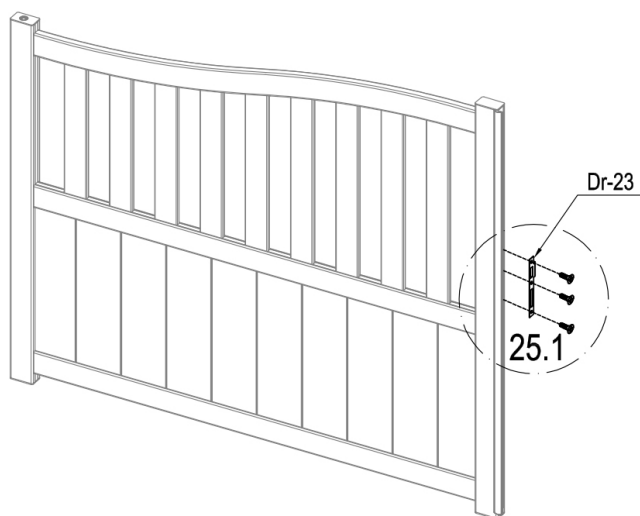

	AT-10	1
	Dr-24	2
	AT-7	2
	Dr-13	1

	Dr-14	1
	SD-C30	2
	SD-C31	2



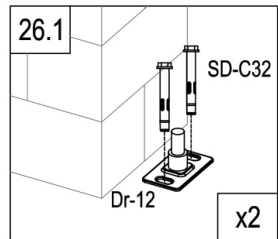
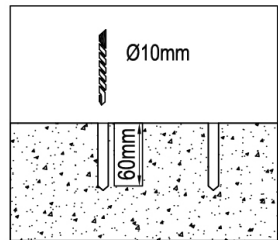
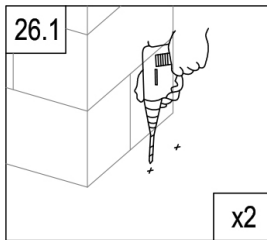
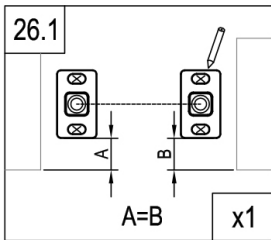
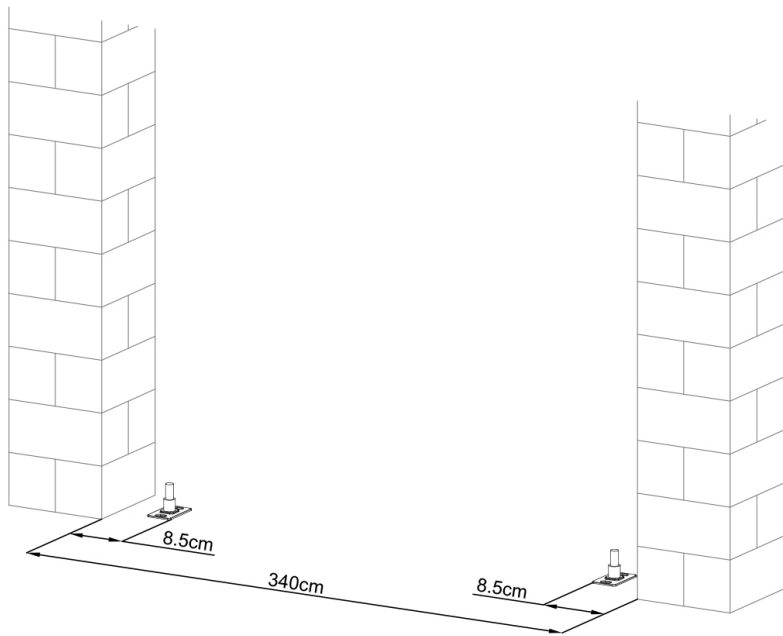

	Dr-23	1
	Dr-26	3



	Dr-12	2
	SD-C32	4

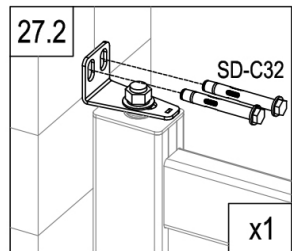
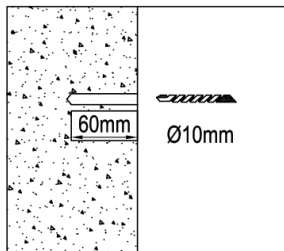
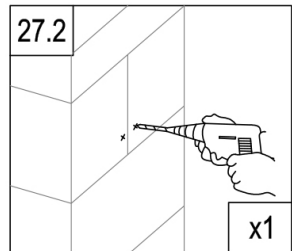
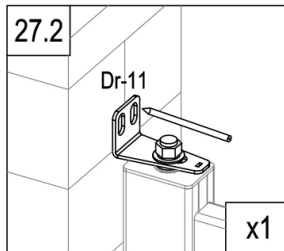
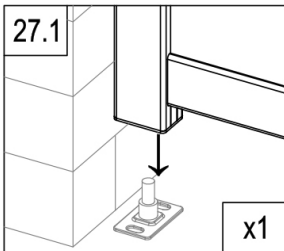
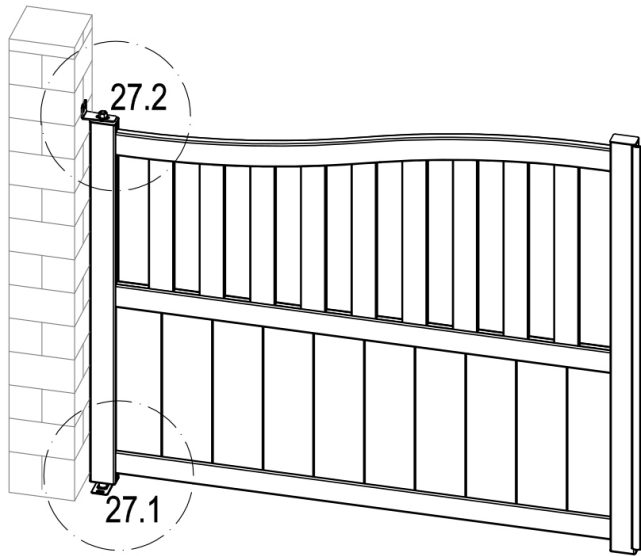

CASANOVO



	Dr-11	1
	SD-C32	2

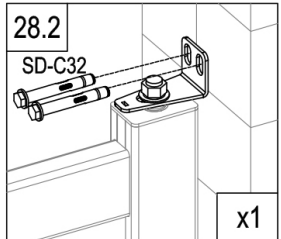
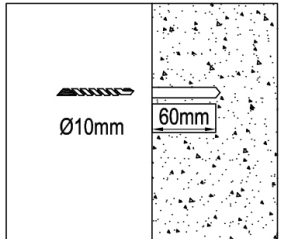
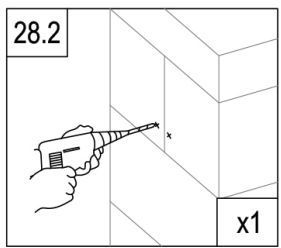
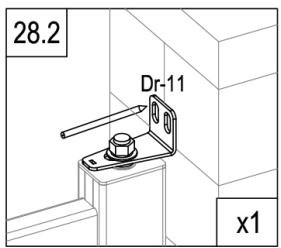
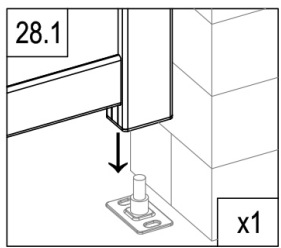
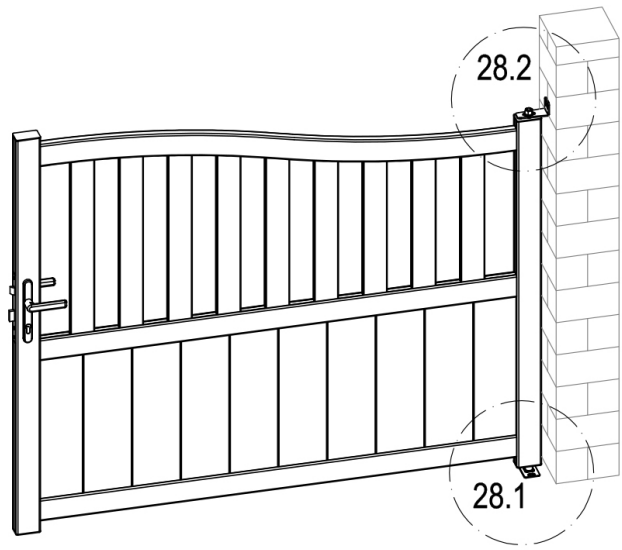

CASANOVO



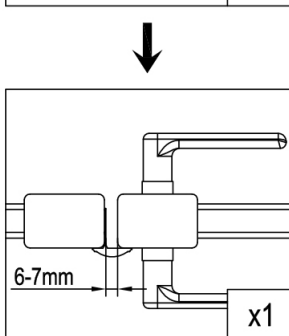
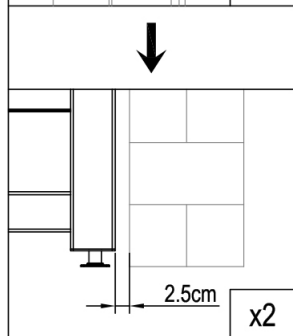
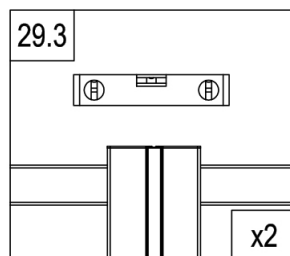
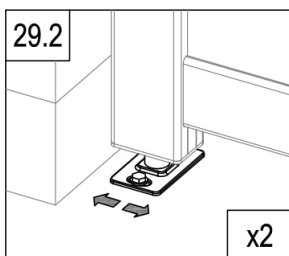
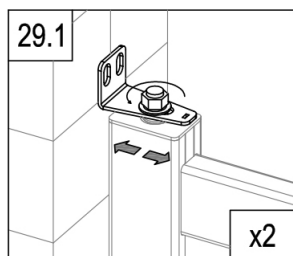
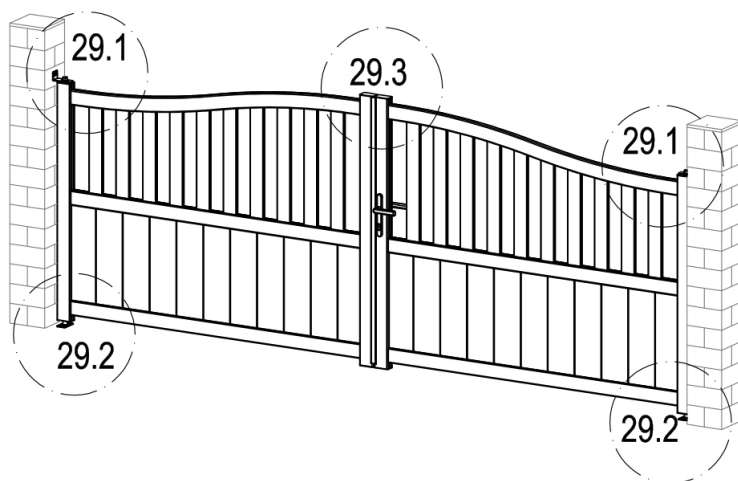

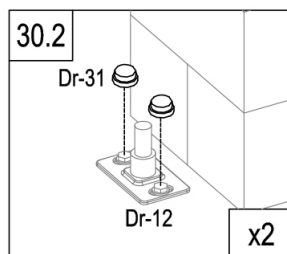
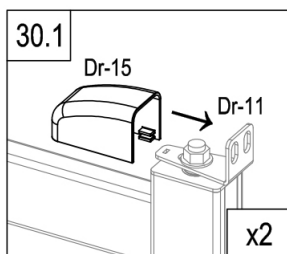
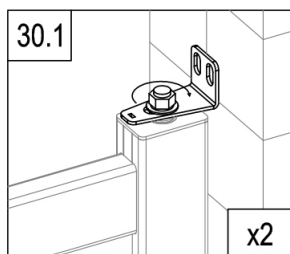
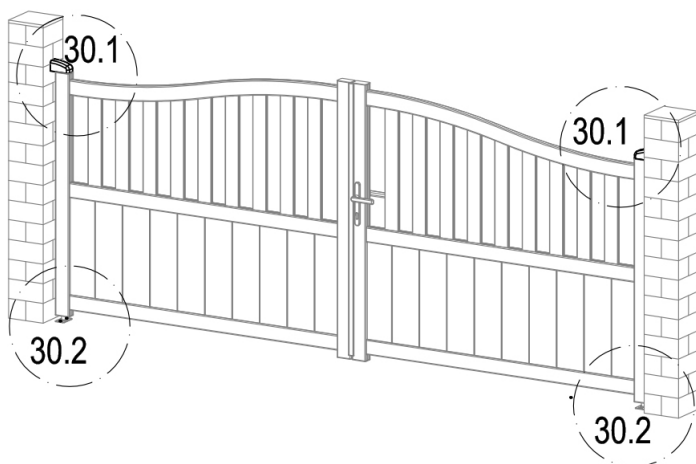

	Dr-11	1
	SD-C32	2



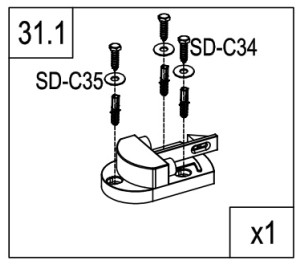
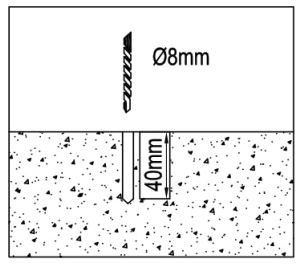
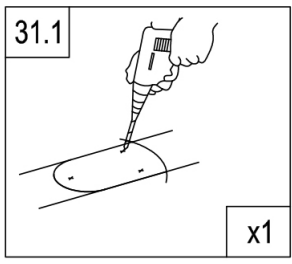
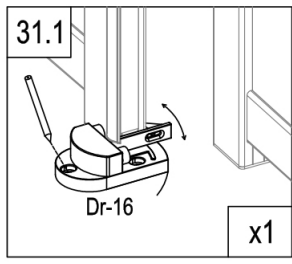
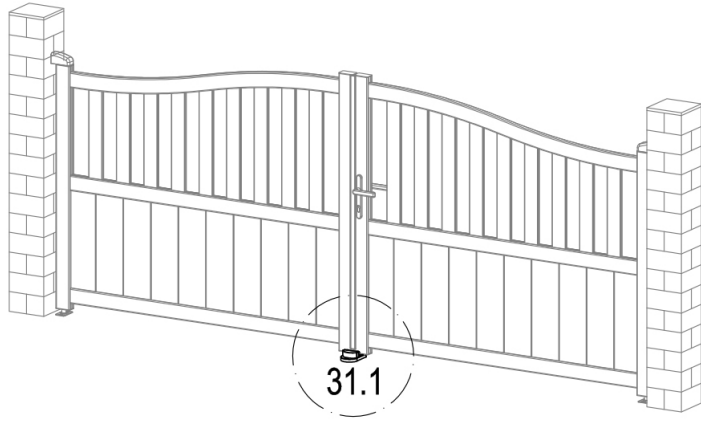



	Dr-15	2
	Dr-31	4

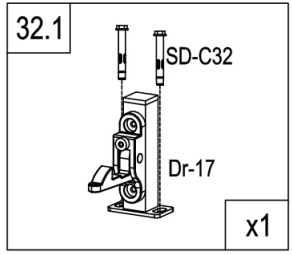
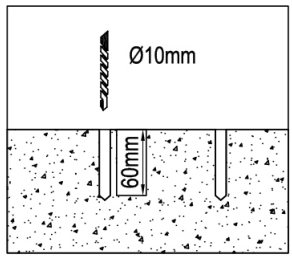
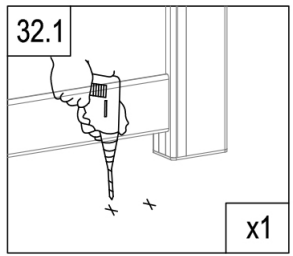
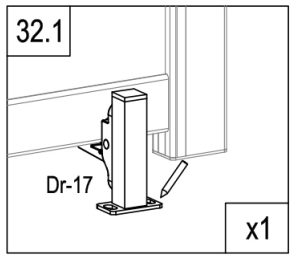
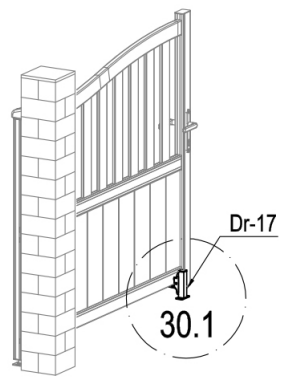
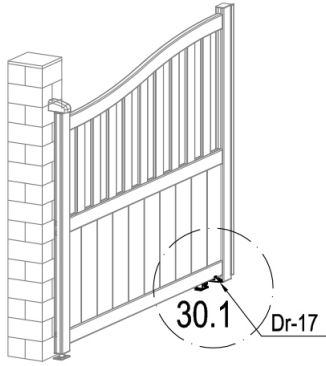

	Dr-16	1
	SD-C34	3
	SD-C35	3



	SD-C32	4
	Dr-17	2